

BEFORE THE PUBLIC UTILITIES COMMISSION

OF THE STATE OF HAWAII

----- In The Matter of ----- )

PUBLIC UTILITIES COMMISSION )

DOCKET NO. 2018-0165

Instituting a Proceeding to Investigate )

Integrated Grid Planning )

\_\_\_\_\_ )

**THE HAWAIIAN ELECTRIC COMPANIES'**

**GRID NEEDS ASSESSMENT METHODOLOGY REVIEW POINT**

**Book 1 of 2**

**Filed November 5, 2021**



November 5, 2021

The Honorable Chair and Members  
of the Hawai'i Public Utilities Commission  
Kekuanao'a Building, First Floor  
465 South King Street  
Honolulu, Hawai'i 96813

Dear Commissioners:

Subject: Docket No. 2018-0165  
Instituting a Proceeding to Investigate Integrated Grid Planning  
Companies' Grid Needs Assessment Methodology Review Point

The Hawaiian Electric Companies<sup>1</sup> respectfully submit the attached November 2021 *Grid Needs Assessment (GNA) and Solution Evaluation Methodology*, which describes the planning criteria and suite of modeling tools and process used to (1) identify the near-term quantity and timing of Grid Needs,<sup>2</sup> (2) develop resource plans to solve for near-term needs and long-term objectives, and (3) evaluate proposed solutions as part of an RFP to meet the Grid Needs. (See Exhibit 1.) Additionally, the Companies also submit the following reports for the Commission's review:

- Exhibit 2 – Transmission Renewable Energy Zone (REZ) Study
- Exhibit 3 – Location-Based Distribution Forecasts
- Exhibit 4 – Distribution DER Hosting Capacity Grid Needs
- Exhibit 5 – AEG IGP Supply Curve Memo
- Exhibit 6 – Redlined Updates to Inputs and Assumptions<sup>3</sup>

Together, these deliverables are responsive to Order No. 37730 and incorporate stakeholder feedback gathered through the engagement process over the past couple of years. Each of these deliverables document the feedback received from stakeholders, and feedback that was incorporated by the Companies. To streamline the review process, stakeholders were provided opportunities to review each of these deliverables throughout the engagement process. The Companies have been appreciative of the time and effort of the stakeholders, Consumer Advocate, and the Commission and their Staff over the past couple of years, and particularly

---

<sup>1</sup> Hawaiian Electric Company, Inc., Hawai'i Electric Light Company, Inc., and Maui Electric Company, Limited are collectively referred to as the "Hawaiian Electric Companies" or the "Companies."

<sup>2</sup> "Grid Needs" means the specific grid services (including but not limited to capacity, energy and ancillary services) identified in the Grid Needs Assessment, including transmission and distribution system needs that may be addressed through a Non-Wires Alternative.

<sup>3</sup> These updates reflect the Companies' evaluation of non-DER, non-EV TOU rates and adjustments to resource cost projections in response to comments from Ulupono, as discussed in the Companies' Reply to Party Comments and Commission Questions filed on September 21, 2021. The Companies intend to issue updated workbooks upon Commission approval of the Inputs & Assumptions to incorporate any additional changes directed by the Commission. For ease of review, Exhibit 6 includes only the redlines of the sections that the Companies have modified to reflect the changes discussed in this footnote.

The Honorable Chair and Members  
of the Hawai'i Public Utilities Commission  
November 5, 2021  
Page 2

over the past year, as many of the technical details were debated and consensus was built. While not every comment or recommendation may have been incorporated, the vast majority have, and this process will continue to evolve and improve as future IGP cycles take place. The Companies believe there are no fatal flaws in the present inputs, assumptions, modeling process, and planning criteria put forward by the Companies, and if approved by the Commission, will yield the information needed to make least-regrets investment and solution sourcing decisions.

It is critical that IGP move forward now to enable rapid progress on the State's RPS and decarbonization goals. IGP is essential to allow informed decision-making on near- and long-term grid reliability and resilience objectives, planning unit retirements, and it will inform issues in a host of different dockets and proceedings. The Companies are committed to expeditiously advancing the IGP process with the continued support of the Commission and stakeholders. Recent discussions with stakeholders indicate they too are ready to move the IGP process forward, noting that we should 'not let the perfect get in the way of the good'.

The Companies are ready to start the Grid Needs Assessment analysis at the direction of the Commission and appreciate the opportunity to provide this Review Point filing to the Commission and stakeholders.

Very truly yours,

/s/ Marc Asano

Marc Asano  
Director, Integrated Grid Planning

Attachments

c: Service List

# EXHIBIT 1

## Grid Needs Assessment & Solution Evaluation Methodology



# **Hawaiian Electric**

## **Grid Needs Assessment & Solution Evaluation Methodology**

November 2021

# Table of Contents

- 1 INTRODUCTION ..... 1
  - 1.1 Intent & Purpose ..... 1
  - 1.2 Modeling Objectives ..... 3
    - 1.2.1 Renewable Portfolio Standards (RPS)..... 4
    - 1.2.2 System Reliability ..... 4
    - 1.2.3 Affordability..... 4
    - 1.2.4 Environmental Carbon Impact Reduction ..... 5
    - 1.2.5 Grid Resilience..... 5
    - 1.2.6 Community Impacts and Land Use ..... 5
- 2 STAKEHOLDER FEEDBACK ..... 7
  - 2.1 Industry Survey Findings ..... 7
  - 2.2 Stakeholder Feedback ..... 10
    - 2.2.1 Solution Evaluation and Optimization Working Group (SEOWG) ..... 12
    - 2.2.2 Stakeholder Technical Working Group (STWG) ..... 14
    - 2.2.3 Additional Stakeholder Feedback in Response to Order No. 37730 ..... 15
    - 2.2.4 Additional Stakeholder Feedback Received on the Grid Needs Assessment Report..... 23
    - 2.2.5 Technical Advisory Panel Review of Grid Needs Assessment Methods and Criteria..... 24
    - 2.2.6 Community Engagement for Project Development ..... 26
- 3 GRID NEEDS ASSESSMENT METHODOLOGY ..... 28
  - 3.1 Overview & Purpose of Modeling Tools ..... 28
  - 3.2 Modeling Framework ..... 29



3.2.1	Capacity Expansion (RESOLVE).....	31
3.2.2	Resource Adequacy (PLEXOS).....	33
3.2.3	Production Cost Simulations (PLEXOS) .....	35
3.2.4	System Security Analysis .....	36
3.2.5	Distribution System Analysis .....	36
3.3	Transmission Needs .....	38
3.3.1	System Security Study .....	38
3.3.2	Renewable Energy Zones (REZ) Study.....	42
3.3.3	Virtual Inertia and Fast Frequency Response Rules in RESOLVE.....	47
3.4	Distribution Needs.....	48
3.5	Grid Needs.....	50
3.5.1	Grid Service Capability by Technology .....	56
3.6	Scenario Design for Grid Service Needs Identification .....	58
3.7	Grid Needs Assessment Modeling Process .....	59
3.7.1	Initial Scenario Analysis.....	59
3.7.2	Preferred Grid Needs Portfolio.....	60
3.7.3	Final Grid Needs Portfolio .....	61
3.7.4	Solution Sourcing.....	61
3.8	Additional Outputs from Grid Service Needs Identificatlon Modeling .....	62
3.8.1	Avoided Cost of Service.....	62
3.8.2	Other Modeling Outputs .....	66
4	<b>SOLUTION EVALUATION METHODOLOGY .....</b>	<b>68</b>
4.1	Overview & Purpose .....	68
4.2	Solution Evaluation Modeling Process .....	68
4.2.1	Program Evaluations .....	68



4.2.2 Programs that Seek Solutions Through Competitive Procurements (Hybrid)..... 69

4.3 Competitive Procurement Evaluations ..... 71

4.3.1 Initial Evaluation of the Price Related Criteria..... 71

4.3.2 Selection of a Priority List..... 72

4.3.3 Detailed Evaluation to Identify Proposals selected to a Final Award Group..... 72

APPENDIX A. RESOLVE & PLEXOS MODELING DESCRIPTION ..... 74

APPENDIX B. MODEL INPUT DEFINITIONS..... 80

APPENDIX C. ENERGY RESERVE MARGIN CRITERIA..... 84

APPENDIX D. REGULATING RESERVE CRITERIA..... 141

APPENDIX E. LOAD BUILD AND LOAD REDUCE CRITERIA..... 174

APPENDIX F. TRANSMISSION PLANNING CRITERIA ..... 176

APPENDIX G. RESILIENCE PLANNING FRAMEWORK..... 229

APPENDIX H. SOLUTION SOURCING DIAGRAM EVOLUTION..... 235

APPENDIX I. DISTRIBUTION PLANNING METHODOLOGY ..... 241

APPENDIX J. NON-WIRES OPPORTUNITY EVALUATION METHODOLOGY ..... 267

APPENDIX K. TECHNICAL ADVISORY PANEL REVIEW ..... 301



# Table of Figures

Figure 1-1: Updated IGP Solution Evaluation & Sourcing Process Diagram ..... 2

Figure 1-2: State of Hawai'i Renewable Portfolio Standard (RPS) Targets by Year ..... 4

Figure 3-1: Grid Needs Assessment Modeling Framework (Adapted from HNEI)..... 28

Figure 3-2: Key Inputs and Outputs of Modeling Steps ..... 30

Figure 3-3: High Level Flowchart of System Security Study..... 39

Figure 3-4: Application of REZ Results in RESOLVE Modeling ..... 45

Figure 3-5: O'ahu REZ Enablement Costs..... 45

Figure 3-6: Hawai'i Island REZ Enablement Costs..... 46

Figure 3-7: Maui REZ Enablement Costs..... 46

Figure 3-8: Distribution Planning Process ..... 48

Figure 3-9: NWA Opportunity Evaluation Methodology ..... 50

Figure 3-10: Example of Monthly Calls for Load Reduce in Year 2025 ..... 55

Figure 3-11: Example of Monthly Calls for Load Reduce Across the Planning Horizon ..... 55

Figure 3-12: Example of Hourly Calls for Load Reduce in 2025 ..... 55

Figure 3-13: Example of Hourly Calls for Load Reduce Across the Planning Horizon ..... 56

Figure 3-14: Example of Shadow Prices Reflecting the Value & Least-Cost Provision of Various Grid Services ..... 65

Figure 3-15: Linkage between avoided costs and capacity expansion and production simulation modeling ..... 66

Figure 4-1: Illustration of Values Derived from Freeze Analysis ..... 69

Figure A- 1: RESOLVE Sampling Process..... 77

Figure A- 2: Illustrative output of RESOLVE Results Tool ..... 78

Figure C- 1: O'ahu Utility Solar Hourly Potential Energy Profiles..... 111

Figure C- 2: O'ahu Wind Hourly Potential Energy Profiles..... 111

Figure C- 3: IGP Modeling Framework..... 113

Figure C- 4: Effective ERM for O'ahu Cases Using Different HDCs ..... 117

Figure C- 5: O'ahu Unserved Energy by ERM Percentage for PLEXOS Stochastic Outage Production Simulation ..... 118

Figure C- 6: O'ahu ERM Test Daily Chart..... 119



Figure C- 7: O’ahu Stochastic Outage Production Simulation Daily Chart ..... 120

Figure C- 8: Hawai’i Island Unserved Energy by ERM Percentage for PLEXOS Stochastic Outage Production Simulation..... 122

Figure C- 9: Hawai’i Island ERM Test Daily Chart..... 123

Figure C- 10: Hawai’i Island Stochastic Outage Production Simulation Daily Chart..... 123

Figure C- 11: Maui Unserved Energy by ERM Percentage for PLEXOS Stochastic Outage Production Simulation ..... 126

Figure C- 12: Maui ERM Test Daily Chart..... 127

Figure C- 13: Maui Stochastic Outage Production Simulation Daily Chart..... 127

Figure C- 14: Lāna’i Unserved Energy by ERM Percentage for PLEXOS Stochastic Outage Production Simulation ..... 130

Figure C- 15: Lāna’i ERM Test Daily Chart..... 131

Figure C- 16: Lāna’i Stochastic Outage Production Simulation Daily Chart ..... 132

Figure C- 17: Moloka’i Unserved Energy by ERM Percentage for PLEXOS Stochastic Outage Production Simulation ..... 134

Figure C- 18: Moloka’i ERM Test Daily Chart..... 135

Figure C- 19: Moloka’i Stochastic Outage Production Simulation Daily Chart ..... 136

Figure D- 1: Sample minutely data of aggregated grid-scale solar generation, aggregated grid-scale wind generation, aggregated grid-scale DER generation, and gross load for January 1, 2017..... 142

Figure D- 2: Sample calculation used to convert the minutely data into a unitized rate of change..... 143

Figure D- 3: Grouping of the minutely data into positive and negative values..... 143

Figure D- 4: Segregation of data based on the month of the year and time of the day. This was done to take into consideration any influence that these parameters have on renewable generation and load..... 144

Figure D- 5: Data flow from minutely data to reserve requirement for each category/month/hour..... 145

Figure D- 6: Comparison of Regulation Up requirement between the current methodology and the proposed methodology for June 13, 2020 for the island of O’ahu ..... 148

Figure D- 7: Comparison of Regulation Up requirement between the current methodology and the proposed methodology for July 11, 2025 for the island of O’ahu ..... 148

Figure D- 8: Comparison of Regulation Down requirement between the current methodology and the proposed methodology for June 13, 2020 for the island of O’ahu ..... 149

Figure D- 9: Comparison of Regulation Down requirement between the current methodology and the proposed methodology for July 11, 2025 for the island of O’ahu ..... 149



Figure D- 10: Comparison of Regulation Up requirement between the current methodology and the proposed methodology for June 15, 2020 for the island of Maui ..... 151

Figure D- 11: Comparison of Regulation Up requirement between the current methodology and the proposed methodology for June 15, 2025 for the island of Maui ..... 151

Figure D- 12: Comparison of Regulation Down requirement between the current methodology and the proposed methodology for June 15, 2020 for the island of Maui ..... 152

Figure D- 13: Comparison of Regulation Down requirement between the current methodology and the proposed methodology for June 15, 2025 for the island of Maui ..... 152

Figure D- 14: Comparison of Regulation Up requirement between the current methodology and the proposed methodology for November 15, 2020 for the island of Moloka’i ..... 154

Figure D- 15: Comparison of Regulation Up requirement between the current methodology and the proposed methodology for August 15, 2025 for the island of Moloka’i ..... 154

Figure D- 16: Comparison of Regulation Down requirement between the current methodology and the proposed methodology for July 15, 2020 for the island of Moloka’i..... 155

Figure D- 17: Comparison of Regulation Down requirement between the current methodology and the proposed methodology for July 15, 2025 for the island of Moloka’i..... 155

Figure D- 18: Comparison of Regulation Up requirement between the current methodology and the proposed methodology for January 15, 2020 for the island of Lāna’i..... 157

Figure D- 19: Comparison of Regulation Up requirement between the current methodology and the proposed methodology for January 15, 2025 for the island of Lāna’i..... 157

Figure D- 20 Comparison of Regulation Down requirement between the current methodology and the proposed methodology for October 15, 2020 for the island of Lāna’i..... 158

Figure D- 21 Comparison of Regulation Down requirement between the current methodology and the proposed methodology for October 15, 2025 for the island of Lāna’i..... 158

Figure D - 22: Comparison of Regulation Up requirement between the current methodology and the proposed methodology for June 14, 2020 for Hawai’i Island ..... 160

Figure D- 23: Comparison of Regulation Up requirement between the current methodology and the proposed methodology for June 16, 2025 for Hawai’i Island ..... 160

Figure D- 24: Comparison of Regulation Down requirement between the current methodology and the proposed methodology for June 14, 2020 for Hawai’i Island ..... 161

Figure D- 25: Comparison of Regulation Down requirement between the current methodology and the proposed methodology for June 16, 2025 for Hawai’i Island ..... 161

Figure F- 1: Typical PV Curve ..... 185

Figure F- 2: Typical PV Curve ..... 203

Figure F- 3: Typical PV Curve ..... 219



Figure G- 1: Resilience Planning Approach.....	229
Figure G- 2: “Bowtie Method” Risk–Threat Assessment .....	231
Figure G- 3: Resilience Solution Portfolio .....	232
Figure H- 1: Initial Solution Sourcing Proposal Introduced on May 9, 2019 .....	235
Figure H- 2: Expanded Sourcing Diagram Introduced on August 1, 2019 .....	236
Figure H- 3: Sourcing Diagram Presented on November 13, 2019 .....	237
Figure H- 4: Sourcing Diagram Presented on December 9, 2019.....	237
Figure H- 5: Sourcing Diagram Presented on January 23, 2020.....	238
Figure H- 6: Sourcing Diagram Presented on February 12, 2020.....	239
Figure H- 7: Sourcing Diagram Presented on March 16, 2020.....	240
Figure I- 1: Stages of the Distribution Planning Process .....	243
Figure I- 2: Data from Prior Years used for Current Year Analysis .....	244
Figure I- 3: LoadSEER SCADA Scrubber Screenshot .....	247
Figure I- 4: Scalable Commercial and Residential Profiles .....	247
Figure I- 5: Example LoadSEER Circuit Forecast.....	248
Figure I- 6: Synergi Screenshot .....	251
Figure I- 7: Existing Hosting Capacity Methodology.....	252
Figure I- 8: Forecasted and Agnostic DER Deployment Scenarios .....	255
Figure I- 9: Daily Hosting Capacity Profile .....	256
Figure I- 10: Daily Hosting Capacity Color Code .....	256
Figure I- 11: Example Daily Percentile–Specific Hosting Capacity Result .....	257
Figure I- 12: N–1 Example .....	258
Figure I- 13: Integrated Grid Needs Map Example .....	261
Figure I- 14: Wires Solution Development Steps.....	263
Figure J- 1: National Grid’s New York NWA Opportunity Evaluation Criteria .....	272
Figure J- 2: SCE NWA Opportunity Prioritization .....	272
Figure J- 3: NWA Opportunity Evaluation Methodology .....	279
Figure J- 4: Example Engineering Analysis and Performance Requirements .....	283
Figure J- 5: T&D NWA Opportunity Evaluation .....	286





Figure J- 6: Salt Lake Boulevard Overhead Line Relocation ..... 289

Figure J- 7: Waiiau–Mililani 46 kV OH to UG Conversion ..... 290

Figure J- 8: Waiiau 46 kV GIS Bus ..... 291

Figure J- 9: Waipio Substation and Circuit Load Growth and Transformer Ratings ..... 292

Figure J- 10: Waipio 1 Transformer Overload ..... 292

Figure J- 11: Ala Moana Area TOD ..... 294

Figure J- 12: Kewalo 6 and Kamoku 10 Circuit Loading (Emergency Condition) ..... 294

Figure J- 13: Kewalo 5 and Kamoku 9 Circuit Loading (Emergency Condition) ..... 295

Figure J- 14: Planned Ho‘opili Development..... 297

Figure J- 15: Kaloi #1 Transformer Loading – Monthly Peak Day in 2023 ..... 298

Figure J- 16: Kaloi #1 Transformer Overload..... 299

Figure K- 1: Revised Process Flow..... 304



# Table of Tables

Table 2-1: GNA Report: Stakeholder Feedback Categories & Responses .....	10
Table 2-2: Participating Organization in SEOWG .....	12
Table 2-3: Schedule and Summary of SEOWG Meetings.....	13
Table 3-1: Transmission Input Summary .....	43
Table 3-2: Inertia Criteria Testing.....	47
Table 3-3: Grid Service Definitions .....	51
Table 3-4: Grid Service Properties for Modeling (1 of 3).....	53
Table 3-5: Grid Service Properties for Modeling (2 of 3).....	53
Table 3-6: Grid Service Properties for Modeling (3 of 3).....	54
Table 3-7: Grid Service Capability by Technology .....	57
Table 3-8: Summary of IGP Modeling Sensitivities.....	58
Table 3-9: Quantity Units, Time Granularity, and Avoided Cost Units for Grid Services .....	62
Table A – 1: RESOLVE and PLEXOS Inputs .....	75
Table B – 1: Model Input Definitions .....	80
Table C – 1: Energy Reserve Margin Percentages by Island.....	87
Table C – 2: Previous Planning Criteria and Consideration .....	91
Table C – 3: Island Largest Unit.....	93
Table C – 4: Oahu Reserve Margin.....	94
Table C – 5: O’ahu Loss of Load Probability Surplus and Shortfalls .....	95
Table C – 6: Hawai’i Island Unserved Energy .....	96
Table C – 7: Islands Energy Reserve Margin Target Stress Test Summary .....	98
Table C – 8: RESOLVE Capacity Expansion Plans for O’ahu .....	115
Table C – 9: PLEXOS 2 Standard Deviation PV HDC ERM Test on RESOLVE O’ahu Plans.....	115
Table C – 10: PLEXOS 1 Standard Deviation PV HDC ERM Test on RESOLVE O’ahu Plans.....	116
Table C – 11: PLEXOS ERM Test without HDCs on RESOLVE O’ahu Plans.....	116
Table C – 12: Supplemental RESOLVE Capacity Expansion Plans for O’ahu .....	116



Table C – 13: PLEXOS Stochastic Outage Production Simulation with RESOLVE Oahu Plans ..... 118

Table C – 14: RESOLVE Capacity Expansion Plans for Hawai‘i Island ..... 120

Table C – 15: PLEXOS ERM Test on RESOLVE Hawai‘i Island Plans ..... 121

Table C – 16: PLEXOS Stochastic Outage Production Simulation on RESOLVE Hawai‘i Island Plans ..... 121

Table C – 17: Supplemental PLEXOS Stochastic Outage Production Simulation on RESOLVE Hawai‘i Island Plans ..... 121

Table C – 18: RESOLVE Capacity Expansion Plans for Maui ..... 124

Table C – 19: PLEXOS ERM Test on RESOLVE Maui Plans ..... 124

Table C – 20: PLEXOS ERM Test on RESOLVE Maui Plans ..... 125

Table C – 21: PLEXOS Stochastic Outage Production Simulation on RESOLVE Maui Plans ..... 125

Table C – 22: PLEXOS Stochastic Outage Production Simulation on RESOLVE Maui Plans ..... 125

Table C – 23: Supplemental PLEXOS Stochastic Outage Production Simulation on RESOLVE Maui Plans ..... 125

Table C – 24: Supplemental PLEXOS Stochastic Outage Production Simulation on RESOLVE Maui Plans ..... 126

Table C – 25: RESOLVE Capacity Expansion Plans for Lāna‘i ..... 128

Table C – 26: PLEXOS ERM Test on RESOLVE Lāna‘i Plans ..... 129

Table C – 27: PLEXOS ERM Test on RESOLVE Lāna‘i Plans ..... 129

Table C – 28: PLEXOS Stochastic Outage Production Simulation on RESOLVE Lāna‘i Plans ..... 129

Table C – 29: PLEXOS Stochastic Outage Production Simulation on RESOLVE Lāna‘i Plans ..... 129

Table C – 30: Supplemental PLEXOS Stochastic Outage Production Simulation on RESOLVE Lāna‘i Plans ..... 129

Table C – 31: Supplemental PLEXOS Stochastic Outage Production Simulation on RESOLVE Lāna‘i Plans ..... 130

Table C – 32: RESOLVE Capacity Expansion Plans for Moloka‘i ..... 132

Table C – 33: PLEXOS ERM Test on RESOLVE Moloka‘i Plans ..... 133

Table C – 34: PLEXOS ERM Test on RESOLVE Moloka‘i Plans ..... 133

Table C – 35: PLEXOS Stochastic Outage Production Simulation on RESOLVE Moloka‘i Plans ..... 133

Table C – 36: PLEXOS Stochastic Outage Production Simulation on RESOLVE Moloka‘i Plans ..... 134

Table C – 37: Supplemental PLEXOS Stochastic Outage Production Simulation on RESOLVE Moloka‘i Plans ..... 134

Table C – 38: Supplemental PLEXOS Stochastic Outage Production Simulation on RESOLVE Moloka‘i Plans ..... 134



Table D – 1: Resources included and excluded from the calculation of Regulation Up and Regulation Down..... 146

Table D – 2: Maximum, Average, and Minimum Regulation Up requirement based on the current methodology used in the PSIP and the proposed methodology for the island of O’ahu 147

Table D – 3: Maximum, Average, and Minimum Regulation Down requirement based on the current methodology used in the PSIP and the proposed methodology for the island of O’ahu 147

Table D – 4: Maximum, Average, and Minimum Regulation Up requirement based on the current methodology used in the PSIP and the proposed methodology for the island of Maui.. 150

Table D – 5: Maximum, Average, and Minimum Regulation Down requirement based on the current methodology used in the PSIP and the proposed methodology for the island of Maui.. 150

Table D – 6: Maximum, Average, and Minimum Regulation Up requirement based on the current methodology used in the PSIP and the proposed methodology for the island of Moloka’i 153

Table D – 7: Maximum, Average, and Minimum Regulation Down requirement based on the current methodology used in the PSIP and the proposed methodology for the island of Moloka’i 153

Table D – 8: Maximum, Average, and Minimum Regulation Up requirement based on the current methodology used in the PSIP and the proposed methodology for the island of Lāna’i 156

Table D – 9: Maximum, Average, and Minimum Regulation Down requirement based on the current methodology used in the PSIP and the proposed methodology for the island of Lāna’i 156

Table D – 10: Maximum, Average, and Minimum Regulation Up requirement based on the current methodology used in the PSIP and the proposed methodology for Hawai’i Island ..... 159

Table D – 11: Maximum, Average, and Minimum Regulation Down requirement based on the current methodology used in the PSIP and the proposed methodology for Hawai’i Island ..... 159

Table D – 12: Impact of Standard Deviation on the Maximum, Average, and Minimum Regulation Up requirement for the island of O’ahu..... 162

Table D – 13: Impact of Standard Deviation on the Maximum, Average, and Minimum Regulation Down requirement for the island of O’ahu ..... 163

Table D – 14: Impact of Standard Deviation on the Maximum, Average, and Minimum Regulation Up requirement for the island of Maui ..... 163

Table D – 15: Impact of Standard Deviation on the Maximum, Average, and Minimum Regulation Down requirement for the island of Maui..... 164

Table D – 16: Impact of Standard Deviation on the Maximum, Average, and Minimum Regulation Up requirement for the island of Moloka’i..... 164

Table D – 17: Impact of Standard Deviation on the Maximum, Average, and Minimum Regulation Down requirement for the island of Moloka’i..... 165

Table D – 18: Impact of Standard Deviation on the Maximum, Average, and Minimum Regulation Up requirement for the island of Lāna’i..... 165



Table D – 19: Impact of Standard Deviation on the Maximum, Average, and Minimum Regulation Down requirement for the island of Lāna‘i ..... 166

Table D – 20: Impact of Standard Deviation on the Maximum, Average, and Minimum Regulation Up requirement for Hawai‘i Island ..... 166

Table D – 21: Impact of Standard Deviation on the Maximum, Average, and Minimum Regulation Down requirement for Hawai‘i Island ..... 167

Table D – 22: Resources included and excluded from the calculation of Regulation Up and Regulation Down for 1-minute intervals ..... 168

Table D – 23: Impact of time interval on the Maximum, Average, and Minimum Regulation Up requirement for the island of O‘ahu ..... 168

Table D – 24: Impact of time interval on the Maximum, Average, and Minimum Regulation Down requirement for the island of O‘ahu ..... 169

Table D – 25: Impact of time interval on the Maximum, Average, and Minimum Regulation Up requirement for the island of Maui ..... 169

Table D – 26: Impact of time interval on the Maximum, Average, and Minimum Regulation Down requirement for the island of Maui ..... 170

Table D – 27: Impact of time interval on the Maximum, Average, and Minimum Regulation Up requirement for the island of Moloka‘i ..... 170

Table D – 28: Impact of time interval on the Maximum, Average, and Minimum Regulation Down requirement for the island of Moloka‘i ..... 171

Table D – 29: Impact of time interval on the Maximum, Average, and Minimum Regulation Up requirement for the island of Lāna‘i ..... 171

Table D – 30: Impact of time interval on the Maximum, Average, and Minimum Regulation Down requirement for the island of Lāna‘i ..... 172

Table D – 31: Impact of time interval on the Maximum, Average, and Minimum Regulation Up requirement for Hawai‘i Island ..... 172

Table D – 32: Impact of time interval on the Maximum, Average, and Minimum Regulation Down requirement for Hawai‘i Island ..... 173

Table F – 1: 46 kV Underground Ampacities ..... 183

Table F – 2: Steady State and Stability Performance Planning Events ..... 192

Table F – 3: Categories of Contingency Events ..... 192

Table F – 4: Steady State & Stability Performance Extreme Events ..... 194

Table F – 5: Steady State & Stability Performance Footnotes (Planning Events and Extreme Events) 195

Table F – 6: Steady State and Stability Performance Planning Events ..... 208

Table F – 7: Categories of Contingency Events ..... 209



Table F – 8: Steady State & Stability Performance Extreme Events ..... 210

Table F – 9: Steady State & Stability Performance Footnotes (Planning Events and Extreme Events)211

Table F – 10: Steady State and Stability Performance Planning Events ..... 225

Table F – 11: Categories of Contingency Events ..... 225

Table F – 12: Steady State & Stability Performance Extreme Events ..... 226

Table F – 13: Steady State & Stability Performance Footnotes ..... 228

Table I – 1: Future Hosting Capacity Enhancements ..... 253

Table I – 2: Demand Forecast ..... 259

Table I – 3: Demand Forecast by Load Type ..... 259

Table I – 4: Grid Needs Assessment ..... 260

Table I – 5: Hourly Grid Needs Summary ..... 260



# 1 Introduction

## 1.1 INTENT & PURPOSE

This document describes how Hawaiian Electric plans to use a suite of modeling tools in the Integrated Grid Planning (“IGP”) Process to:

1. Identify the near-term quantity and timing of Grid Needs<sup>1</sup> that will drive future program development and procurement in each IGP cycle as part of the Grid Needs Assessment<sup>2</sup> over the next decade;
2. Develop resource plans to identify potential pathways to solve for near-term needs and long-term objectives such as achieving 100 percent renewable energy by 2045; and
3. Evaluate proposed solutions as part of an RFP to meet the Grid Needs defined in the Grid Needs Assessment (“GNA”).

The main body of this document focuses on the overall process flow of and methodology behind the modeling and analysis, conducted in RESOLVE & PLEXOS, among other modeling tools, to derive the Grid Needs to inform solution sourcing and to evaluate or select solutions. Hawaiian Electric worked extensively with the Solution Evaluation Optimization Working Group (“SEOWG”), the Stakeholder Technical Working Group (“STWG”), the Technical Advisory Panel (“TAP”), and the Stakeholder Council 2019 through 2021 to develop the methodologies.

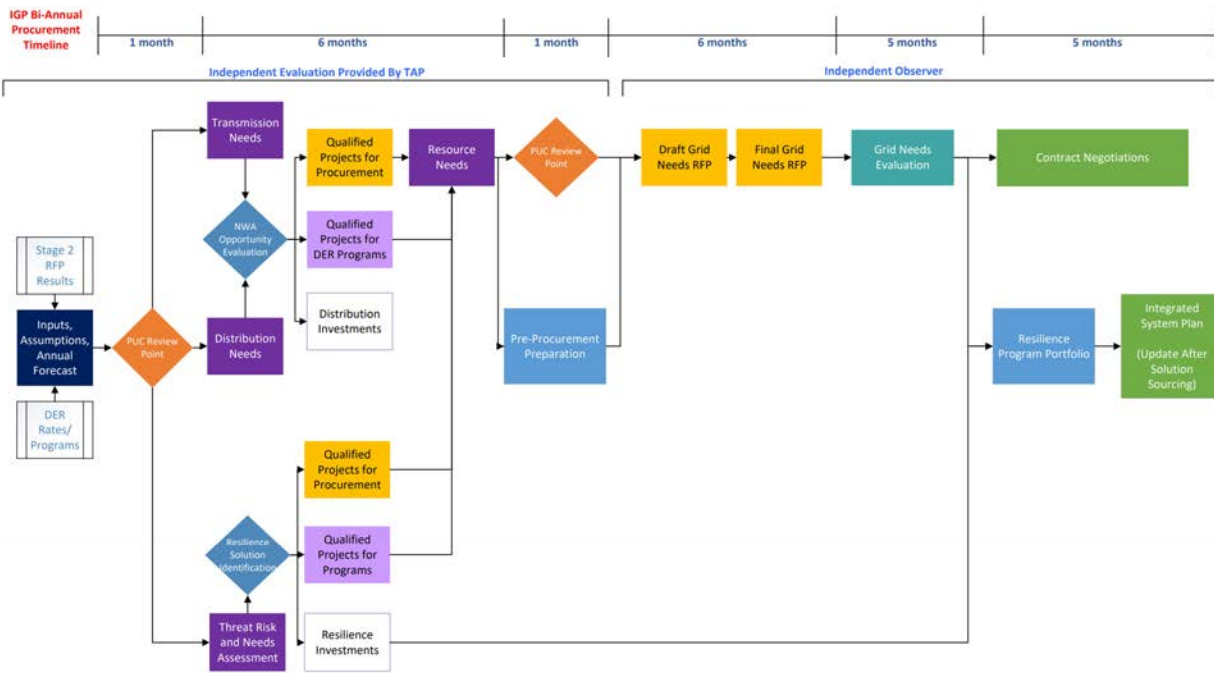
---

<sup>1</sup> “Grid Needs” means the specific grid services (including but not limited to capacity, energy and ancillary services) identified in the Grid Needs Assessment, including transmission and distribution system needs that may be addressed through a Non-Wires Alternative.

<sup>2</sup> “Grid Needs Assessment” means the process step in the IGP where the technical analyses are conducted to determine the generation, transmission, and distribution grid service(s) needs to serve our customers while meeting state policy objectives, reliability standards, among other goals. The Grid Needs Assessment will be presented to the Commission for review and approval.



Figure 1-1: Updated IGP Solution Evaluation & Sourcing Process Diagram



The process flow in Figure 1-1 starts with the development of the inputs and assumptions used for the modeling analysis and includes the selected projects from the Stage 2 RFP and updates on any new rates and programs for DER resources. Together, these inputs and assumptions formed the first review point to be reviewed by the Commission, Consumer Advocate, Technical Advisory Panel, the Parties, and stakeholders. Details are available through several documents:

- 2021 IGP Inputs and Assumptions, August 2021 Update<sup>3</sup> (“August I&A Update”)
- Model Inputs and Assumptions Workbooks<sup>4</sup>
- IGP Stakeholder Feedback Summary, March 2021<sup>5</sup>

Once the inputs and assumptions have been established, the planning work to identify the transmission, distribution, and resource Grid Needs on an integrated basis will commence. Collectively, the analyses for these Grid Needs will form the Grid Needs Assessment. The NWA opportunity evaluation process (see Appendix J) will be applied to the transmission and distribution needs to categorize their fit for a future procurement, program, or utility investment. Needs that could potentially be fulfilled in a procurement or program will be

<sup>3</sup> Available at, <https://www.hawaiianelectric.com/clean-energy-hawaii/integrated-grid-planning/stakeholder-engagement/key-stakeholder-documents>, latest version available under “Inputs and Assumptions”.

<sup>4</sup> Inputs workbooks for O’ahu, Hawai’i Island, Maui, Moloka’i, and Lāna’i, available under “Inputs and Assumptions” at <https://www.hawaiianelectric.com/clean-energy-hawaii/integrated-grid-planning/stakeholder-engagement/key-stakeholder-documents>

<sup>5</sup> Available at, [https://www.hawaiianelectric.com/documents/clean\\_energy\\_hawaii/integrated\\_grid\\_planning/dkt\\_2018\\_0165\\_20210304\\_HECO\\_reply\\_comments.pdf](https://www.hawaiianelectric.com/documents/clean_energy_hawaii/integrated_grid_planning/dkt_2018_0165_20210304_HECO_reply_comments.pdf)





included as part of the resource portfolio that is developed in the resource needs process step. The NWA framework is further described in the *Non-Wires Opportunity Evaluation Methodology* (Appendix J).

In parallel with the transmission, distribution, and resource needs analyses, the resilience planning process step will begin, starting with the threat-risk and needs assessment. The threat-risk and needs assessment builds upon the work completed by the Resilience Working Group to identify and prioritize threats and locational analysis developed by Jupiter Intelligence to prioritize locations and assets most at risk from flooding and wind. Similar to the NWA process, resilience needs that can be addressed through a procurement or program will be included as part of the resource portfolio in the resource needs process step. The resilience framework is further described in Appendix G, *Resilience Planning Framework*.

The analyses that make up the Grid Needs Assessment will form the Second Review Point. While the analyses are under review, preparations for a long-term program or competitive procurement that seeks to address the identified needs will begin. This includes stakeholder discussions on various solutions sourcing mechanisms to meet the Grid Needs. Projects that are proposed through a competitive procurement will be overseen by an Independent Observer. The procurement process will include bid evaluations and contract negotiations with final awardees.

After determining the final awardees in the Grid Needs procurement, the portfolio of grid needs, including resilience, will be evaluated to assess what residual needs remain to be met, in priority order. The Companies' resource plans will also be updated with the known set of projects or programs resulting from the Grid Needs solution sourcing efforts. Solution sourcing is further described in Section 3.7.4. If there are residual needs from the Grid Needs procurement, a follow-on residual needs solution sourcing may be conducted.

---

## 1.2 MODELING OBJECTIVES

The Company aims to achieve six overarching objectives to deliver reliable, clean, and cost-effective service to customers.

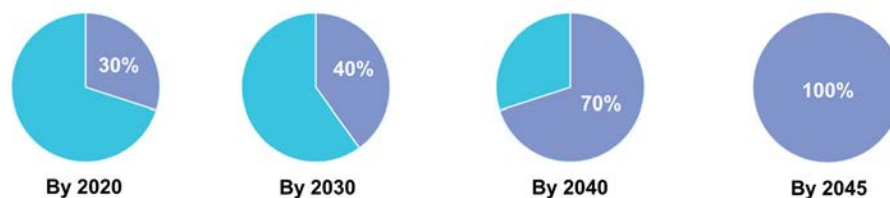
- Renewable Portfolio Standards
- System Reliability
- Affordability
- Environmental Carbon Impact Reduction
- Grid Resilience
- Community Impacts and Land Use



### 1.2.1 Renewable Portfolio Standards (RPS)

The Grid Needs Assessment will seek to achieve and accelerate the State of Hawai'i's Renewable Portfolio Standards ("RPS")<sup>6</sup> mandate of achieving 100 percent of net electricity sales from renewable generation by year 2045, with breakout targets shown in Figure 1-2.

Figure 1-2: State of Hawai'i Renewable Portfolio Standard (RPS) Targets by Year



Under performance based regulation, the Company is incentivized to accelerate renewable energy achievement through annual targets and a renewable portfolio standard calculation that is based on total renewable energy generated, including customer-sited renewables, instead of the current RPS calculation based on sales. As recommended by the Stakeholder Council, the Grid Needs Assessment should seek a portfolio that recognizes the RPS-A performance incentive mechanism.

### 1.2.2 System Reliability

The Grid Needs Assessment will account for multiple factors that assure system reliability; including the Grid Needs (*e.g.*, system balancing, system security, T&D reliability, etc.) as described herein. Additionally, the Company is accountable for Adequacy of Supply,<sup>7</sup> which is the ability of the electric system to supply the aggregate electrical demand and energy requirements of our customers at all times, taking into account scheduled and reasonably expected unscheduled outages of system elements. Aspects of reliability will be evaluated through the Grid Needs Assessment for adherence to various reliability related planning criteria and guidelines.

### 1.2.3 Affordability

The RESOLVE model will develop a resource portfolio to solve for RPS and System Reliability objectives in a least-cost manner. The model will also consider the costs of installing new resources as well as the costs of operating existing resources in the development of the resource plans. The resource plan will provide insight into resource procurement and system investment decisions needed to achieve 100 percent renewable energy and inform new programs and procurements over the short-term and long-term horizon (20-30 years).

<sup>6</sup> See HRS § 269-92 Renewable Portfolio Standards.

<sup>7</sup> See Adequacy of Supply filings, <https://puc.hawaii.gov/reports/energy-reports/adequacy-of-supply/>



## 1.2.4 Environmental Carbon Impact Reduction

With increasing renewable generation on the utility system and the retirement of fossil fuel generating units, the expectation is that greenhouse gas (“GHG”) emissions will be significantly reduced. Long-term plans can be qualitatively and quantitatively assessed for GHG reduction. Quantitative GHG reduction assessments of resource plans may also incorporate achievement of certain GHG reduction targets or estimated reductions from an energy ecosystem perspective to include estimated reductions gained through electrification of other sectors, including transportation, buildings, etc.

## 1.2.5 Grid Resilience

There are two primary ways of looking at grid resilience. The first involves hardening of existing grid infrastructure (*e.g.*, upgrades to utility poles, transmission and distribution line monitoring, transformers, etc.) and the second includes the ability of the system to return to service in a major outage event (*e.g.*, hurricane, tsunami, act-of-god, etc.). As outlined in the *Resilience Working Group Report for Integrated Grid Planning*,<sup>8</sup> comments from first responders, other infrastructure owners, and other RWG participants will be used to inform transmission and distribution planning needs, priorities for resilience improvements, and options to achieve those identified planning needs and priorities. Notably, this includes consideration of resilience enhancing microgrids to provide local, emergency power generation when parts of the system’s transmission and/or distribution system are out of service due to emergency conditions.

Figure 1-1 illustrates how resilience is directly incorporated into the IGP process as part of the Grid Needs Assessment. Further details of the resilience needs assessment are provided in Appendix G.

## 1.2.6 Community Impacts and Land Use

The viability of a long-term plan will depend on an assessment of the community impacts and land use in Hawaii. It is imperative that any long-term plans balance multiple state policy objectives, such as housing, energy, and food sustainability. The IGP process will be responsive to the feedback received as part of the Company’s broad public engagement.<sup>9</sup>

Stakeholder Council feedback on community impacts and land use can help inform and modify certain planning inputs used in the modeling. As an example, one of the key inputs into the modeling is the resource potential for land-based resources that define the maximum capacity of each resource that can be developed on each island. As part of the modeling input development, Hawaiian Electric engaged NREL to update the resource potential study conducted during the 2016 Power Supply Improvement Plan (“PSIP”). Results of the updated

---

<sup>8</sup> See <https://www.hawaiianelectric.com/clean-energy-hawaii/integrated-grid-planning/stakeholder-engagement/working-groups/resilience-documents>

<sup>9</sup> See <https://www.hawaiianelectric.com/clean-energy-hawaii/integrated-grid-planning/stakeholder-engagement/broad-public-engagement>



analysis<sup>10</sup> that directly incorporated feedback from stakeholders were shared with the IGP Stakeholder Council and used as part of the Renewable Energy Zone analysis, as described in Section 3.3.2.

---

<sup>10</sup> Available at, [https://www.hawaiianelectric.com/documents/clean\\_energy\\_hawaii/integrated\\_grid\\_planning/stakeholder\\_engagement/stakeholder\\_council/20210730\\_sc\\_heco\\_tech\\_potential\\_final\\_report.pdf](https://www.hawaiianelectric.com/documents/clean_energy_hawaii/integrated_grid_planning/stakeholder_engagement/stakeholder_council/20210730_sc_heco_tech_potential_final_report.pdf)



## 2 Stakeholder Feedback

The following discussion summarizes the combined learnings from leading states and experts, and feedback from stakeholder discussions held with the Stakeholder Council, Solution Evaluation Optimization Working Group (“SEOWG”), Stakeholder Technical Working group (“STWG”), and Technical Advisory Panel.

---

### 2.1 INDUSTRY SURVEY FINDINGS

Hawaiian Electric met with other utilities from the U.S. and Australia. At these meetings the other utilities discussed what did and did not work for them during their grid needs assessment and solution evaluation approaches. Based on their experience they have all generally said that they improved the outcome of their competitive solicitation process by providing more operational and technical detail about what specific need was being addressed in technology neutral terms. More specific and clear requirements presented in the Request for Proposal (“RFP”) process tended to result in more thorough and consistent responses from bidders. Bidders appreciated the additional detail, because it allowed them to make better decisions about solicitations to pursue where they felt their proposal could be most competitive. They also instilled the importance of preparing structured bid response forms as well as including pro-forma contracts that allowed bidders to prepare accurate and complete proposals that in turn were more easily understood, resulting in a faster evaluation. For example, National Grid<sup>11</sup> indicated process improvements for their NWA RFP including:

- Problem statement of electrical system need
- Better system data and Loading data
- General description of the system need
- Timing, duration of the need, and time of day the need occurs
- Aggregated customer load profiles (no individual customers are identified)
- Area and electrical system description
- Equipment listings, voltages, and mapping
- Approximate value of NWA solution
- Process improvements included:
  - Consistent format
  - More descriptive problem statement
  - Technical details expanded
- Collection of market interest to participate in a specific RFP

---

<sup>11</sup> August 1, 2019, Solution Evaluation & Optimization Working Group Meeting, available at: [https://www.hawaiianelectric.com/documents/clean\\_energy\\_hawaii/integrated\\_grid\\_planning/stakeholder\\_engagement/working\\_groups/solution\\_evaluation\\_and\\_optimization/20190801\\_wg\\_seo\\_meeting\\_presentation\\_materials.pdf](https://www.hawaiianelectric.com/documents/clean_energy_hawaii/integrated_grid_planning/stakeholder_engagement/working_groups/solution_evaluation_and_optimization/20190801_wg_seo_meeting_presentation_materials.pdf)



- Working with internal DR and EE programs to find opportunities to reduce a load relief need
- Exploring software that will help National Grid optimize DER locations on the grid to develop more focused RFPs
- More comprehensive vendor and stakeholder contracts
- Monthly Stakeholder engagement sessions
- Shared email box for vendor communications

The Australian Energy Market Operator (AEMO) also provided insights into the Integrated System Planning process. The key highlights include:

1. **Renewable Energy Zone (REZ):** Areas or zones that have been identified for potential renewable energy development with consideration for a host of other external factors
2. **Cost of Land/Population Density:** Australia did not consider the cost of land in the weighting determinations for each REZ but did consider population density. There is some correlation because in general, land is more expensive where more people live.
3. **Resiliency:** Australia did not initially consider this factor in its planning; however, resiliency is an issue that many globally are trying to address/resolve, though none have solved it yet. AEMO uses a probabilistic planning standard for reliability to incorporate the cost of an outage. However, it is difficult to predict when a high impact, low probability event will happen.
4. **Indigenous people:** The challenge of dealing with the cultural concerns or native land issues raised by indigenous people in making plans to build out facilities was raised. For Australia, they tried to identify at an early stage which areas to be developed and reached out to indigenous people but have not had much contact with such groups. However, there is a process for dealing with what they refer to as “traditional landowners.” There was an example on one site where aboriginal artifacts were found and the project was delayed. While they haven’t received much feedback from indigenous groups in the ISP process, such groups usually do not get involved until later stages of these matters, which can be difficult to accommodate issues at the later date.
5. **Load Demand Profile:** Demand shape is very steep. It used to be in the middle of the day demand is high, in the evening, demand is low. Over time, with rooftop solar increases, this shifted such that now peak demand is high in middle of the evening instead, around 7pm.
6. **Optimization for REZ:** For each REZ, there’s a resource profile that indicates what a particular renewable resource will generate at any given time. There’s also an associated cost and network hosting capacity i.e., how much you can connect at the moment. Once it reaches the hosting capacity limit, then there is a penalty cost. For each REZ, AEMO has a plan to augment that zone and then translate that augmentation cost down to dollars per kilowatt.



7. **Timeframes to build transmission:** Construction may take 4 years for new transmission lines but there have been delays out to 10 years. In general, renewable generation can be built much quicker than transmission lines. For example, a solar farm can be built in 1 year, wind farms in 2 years, while transmission lines can take 4 to 5 years to build. Regulators and customers are risk averse when it comes to potentially overbuilding transmission capacity in anticipation of new generation resources.
8. **Optimizing rooftop batteries/solar distributed energy resource (DER):** Approach each by scenario. Have a specific plan to address a scenario with a lot of DER versus a scenario where there is little DER. Trying to flatten out the load to find where more investment is needed. Planning is primarily concerned with DER offsetting demand although there are some aggregators that participate in the market.
9. **Battery Storage:** Battery storage for homes have had some trials, but battery uptake in houses is extremely low. At one point, Australia could claim the world's biggest battery when it was built and now at the utility scale, larger batteries are being built. Batteries are heavily subsidized at utility level, but at some point they will also see this industry flourish like the rooftop solar industry. Batteries can defer a large network investment, but more of what has been seen is that private investors have installed them to participate in the frequency control market.
10. **Coal plant operating life:** The most important element of the ISP was examining the operating life of coal plants to determine when they could be retired. It was determined that replacement was necessary after 50-60 years. These power stations are all privately owned and in the ISP, AEMO assumed a 50-60 year life, but know that some leeway exists. Power station operators are now required to signal three years out that the expected operating life is coming to an end, and coal plant owners make the announcement of the plant closure to the public. Some plants may be retired earlier than the 50-60 projection of life cycle.
11. **Production Cost Modeling and Optimization:** The first stage of optimization uses a load duration curve then moves into a load block approach, which splits a day into a few periods to determine whether the resource is available during those time periods, then finally an hour by hour simulation to test what those earlier models determined. The model is a least cost model that is bound by constraints on renewable energy targets.
12. **Optimizing behind the meter resources:** No attempt was made to fully optimize the system including behind meter resources; however, there has been feedback that they should try to do that. Australia tried to flatten the demand curve and found there is a lot of value in having high DER. The challenge they have is knowing how much a coal power station costs, how much a wind farm or solar farm costs, but aggregation of DER is already there, but it is very difficult to understand how much it will cost and how flexible it is.
13. **Incorporating Distribution Planning:** Australia has been trying to understand hosting capacity of each distribution network. Trying to understand how much DER can be accommodated in their network and then how much would it cost to increase that



hosting capacity. Because the network is so vast, it would increase complexity of the process exponentially. Currently, they are relying on high level information to understand the hosting capacity limit. Moving forward, working towards next iteration of the ISP in December 2020, which will be a struggle. Working with a new DER team that was set up in the organization to try to facilitate and promote engagement in existing markets and understanding how the existing markets should be changing.

- 14. Impact of natural disasters on the grid:** In Australia, bushfires and drought became more abundant and severe and have negatively impacted transmission. When planning new transmission corridors, AEMO is very cognizant of potential for bushfires.

## 2.2 STAKEHOLDER FEEDBACK

The Company has held fifteen stakeholder working group meetings through the first quarter of 2021 for the SEOWG that have discussed the timeline and methodology for (1) identifying the timing, quantity, and value of various Grid Needs, (2) evaluating potential solutions received in a competitive procurement or a utility program, and (3) presenting initial, preliminary results of the RESOLVE models using the assumptions that have been developed through the Forecast Assumptions Working Group.

A majority of the feedback received (both verbal and written) were questions and requests for clarification, which have been addressed either in the working group forums or have been logged and responses developed and presented in the detailed stakeholder feedback provided in Appendix B to the *IGP Stakeholder Feedback Summary, March 2021* report.

Feedback on the GNA Report consisted of more than 260 distinct comments, suggestions, questions, and edits which were grouped into 15 categories as shown in Table 2-1.

Table 2-1: GNA Report: Stakeholder Feedback Categories & Responses

No.	Category	Clarification	Incorporated	Total
1	Edit or format suggestions to improve clarity	9	43	52
2	Grid Services Definition Methodology	39	11	50
3	Sensitivity Analysis	26	4	30
4	Grid Services	20	7	27
5	Model Mechanics	13	7	20
6	GNA Modeling Process	12	5	17
7	Transmission Needs	12	5	17
8	Resource Characteristics	12	2	14
9	Avoided Cost of Service	10	3	13
10	IGP Solution Sourcing Process	3	1	4
11	Modeling Inputs	3	1	4





No.	Category	Clarification	Incorporated	Total
12	Solution Evaluation Method	3	1	4
13	Stakeholder Feedback	3	1	4
14	Solution Evaluation Methodology – Avoided Cost Screen	4	0	4
15	Grid Services Scenario Analysis	1	2	3

In Table 2-1, “Clarification” means stakeholder feedback that was provided either as a question or a comment and was responded to for clarification only. This feedback may not have been directly reflected in the GNA report. “Incorporated” means stakeholder feedback resulted in either a direct change to the GNA report, and/or the feedback resulted in a direct change or modification of an analysis or assumption which modified a forecast, which then informed the GNA Report.

During this process, stakeholders asked the Company to clarify and capture the suggestions and modifications to the initially proposed needs assessment and solution evaluation methodology and process in this methodology document. The following is a high-level summary of changes and modifications adopted:

1. Inputs and methodology descriptions for the ecosystem of models used in the GNA (RESOLVE and PLEXOS models for the resource needs, PSS/E, PSCAD, and ASPEN for transmission and system security needs, Synergi and LoadSEER for distribution needs) to help stakeholders understand the strengths and limitations of the modeling framework and the iterative modeling approach taken within the system security step to fully address grid needs between these models;
2. Coordination with the Forecast Assumptions Working Group (“FAWG”) to share forecast assumption inputs earlier in the stakeholder engagement process to facilitate more robust discussion on sensitivity analysis;
3. Identify an Independent Evaluator for the Grid Needs Assessment phase and Independent Observer for the Solution Evaluation phase to provide oversight on the modeling and evaluation process;
4. Incorporation of utility programs and non-wires alternatives (“NWA”) RFP within the IGP process to provide equal evaluation across resource types;
5. Clarification on the definitions and methodologies used to support identification of the Grid Needs;
6. Inclusion of mechanisms to gauge market interest in long-term projects within the IGP process with the possibility of including them into the IGP cycle;
7. Development of a diagram that depicts a high-level connection between one procurement cycle and the next to clarify the overarching process; and
8. Development of diagrams that show detail of the Transmission and Distribution Needs, and Grid Needs processes.

Further details of the stakeholder feedback that have been received and incorporated are described in *IGP Stakeholder Feedback Summary, March 2021*.



### 2.2.1 Solution Evaluation and Optimization Working Group (SEOWG)

The purpose of the SEOWG was to develop a process for assessing Grid Needs using the Company’s load forecast that was informed by the work of the FAWG along with other key inputs and assumptions used by the RESOLVE and PLEXOS models. The Grid Needs Assessment would include a reference portfolio of resources to serve load and provide grid services (Grid Needs). The SEOWG was also chartered to develop and recommend a transparent evaluation and optimization method to fairly assess proposed solutions identified in a solution sourcing procurement process.

As part of the process for developing the Grid Needs Assessment, the SEOWG was also tasked with identifying and defining additional services that may be needed in support of IGP Solution Sourcing for the first IGP cycle. As the GNA was being developed, it became evident through discussion and feedback from stakeholders that a separate deliverable for documenting and detailing the Inputs and Assumptions would be necessary and helpful for stakeholders to gain a better understanding of the underlying assumptions and supporting data used to drive the forecasts as well as how those forecasts and assumptions are used as input to the modeling used to generate the GNA. The SEOWG used many of the work products and incorporated detailed data considerations from the FAWG in the development of the inputs and assumptions report.

The SEOWG has engaged with 18 different organizations during the stakeholder engagement process.<sup>12</sup> The Company has held fifteen SEOWG meetings through February 2021 in which stakeholders discussed the timeline and methodology for (1) identifying the timing, quantity, and value of various Grid Needs, (2) evaluating potential solutions received in a competitive procurement or a utility program, and (3) presenting initial, preliminary results of the RESOLVE model using the assumptions that have been developed through the FAWG and STWG and further detailed in the August I&A Update.

Table 2-2 provides a listing of the organizations that participated in the SEOWG meetings.

Table 2-2: Participating Organization in SEOWG

Organizations	
Public Utilities Commission Staff	Rocky Mountain Institute
County of Hawaii	Department of Commerce and Consumer Affairs, Division of Consumer Advocacy
Blue Planet	Energy Island
Hawai'i PV Coalition	Hawai'i Solar Energy Association

<sup>12</sup> See Hawaiian Electric Companies Update IGP Workplan & Review Point Report, January 2021: Section 2.6, page 29.



## Organizations

Life of the Land	Progression Hawaii Offshore Wind
Renewable Energy Action Coalition of Hawai'i	Ulupono Initiative
Hawai'i Natural Energy Institute	Nexamp
Salt River Project	Hawai'i State Energy Office
Hawai'i Energy	Telos Energy

### 2.2.1.1 Schedule of SEOWG Meetings

A summary of the SEOWG meetings held to date are provided in Table 2-3. Through these SEOWG meetings, stakeholders had the opportunity to learn about the Company's methods for developing its Grid Needs Assessment and for conducting its solution sourcing evaluations. The SEOWG provided a venue for stakeholders to provide feedback on the Company's proposed methodologies to develop the GNA.

Table 2-3: Schedule and Summary of SEOWG Meetings

Meeting	Summary of Agenda
1. <b>May 9, 2019 – Kickoff</b>	Overview of SEOWG and IGP process.
2. <b>August 1, 2019 – Panel Discussion</b>	Panel presentations on evaluation methodologies by other utilities. Discuss revisions to IGP process flow.
3. <b>September 20, 2019 – Resource Needs Planning</b>	Review resource planning and RFP evaluation process steps in detail.
4. <b>October 30, 2019 – SEOWG Deliverable Outline Discussion</b>	Review an initial outline of the SEOWG deliverable.
5. <b>November 13, 2019 – IGP Process Flow and Future Procurements</b>	Discuss revisions to IGP process flow and pathway for future procurements, including a long-term RFP .
6. <b>December 9, 2019 – Solution Evaluation Methodology and Modeling Sensitivities</b>	Review updates to the IGP process flow and decomposition of the resource planning step. Introduce the RESOLVE and PLEXOS models, a proposal for solution evaluation, and proposed modeling sensitivities developed with stakeholder feedback.



Meeting	Summary of Agenda
7. January 23, 2020 – Cost Forecasts and Grid Services	Review the fuel forecast and resource cost forecast for IGP, introduce the set grid services to be evaluated through the planning work, and continue discussions on modeling sensitivities.
8. February 12, 2020 – IGP Soft Launch Evaluation Methodology	Review updates to modeling sensitivities. Introduce the evaluation methodology for the IGP Soft Launch.
9. March 16, 2020 – Stakeholder Feedback on SEOWG Deliverable	Review stakeholder feedback on the redlined SEOWG deliverable outline and modeling sensitivities.
10. April 20, 2020 – Grid Needs Assessment	Review updates to the fuel forecast and resource costs. Review example outputs of the Grid Needs Assessment.
11. May 22, 2020 – Energy Reserve Margin, Load Build/Reduce, and Grid Service Capability	Introduce the Energy Reserve Margin service for capacity, methodologies for identifying load build and load reduce needs, and linkage between resources and their grid service capability.
12. June 30, 2020 – Transmission Needs	Introduce the transmission planning criteria and planning for transmission needs. Review stakeholder comments on the Grid Needs Assessment and Solution Evaluation.
13. October 2, 2020 – Preliminary Model Results	Discuss preliminary results of the RESOLVE modeling using the assumptions developed to date.
14. January 22, 2021 – NREL Offshore Wind Study	Discussed proposed Hawaii offshore wind study conducted by NREL.
15. February 26, 2021 – Review of Stakeholder Feedback on GNA Report	Review Stakeholder feedback received on GNA Report.

## 2.2.2 Stakeholder Technical Working Group (STWG)

Upon completion of the SEOWG, the Company formed the STWG address input and feedback on technical issues and increase transparency in the subsequent steps of the IGP process. For example, this technical working group could be used to solicit feedback on NWA opportunities, other acquisition of grid services, modeling sensitivity results, etc. The STWG met between June 2021 through August 2021 to discuss the revised inputs and assumptions. The work of the STWG during those meetings are well documented in the August I&A Update. As discussed in the Company's September Status Update, meetings in October meetings were scheduled to discuss items related to this report.



- October 6, 2021 – Circuit Hosting Capacity and Locational Forecasts, REZ Assessment, System Security Process; and
- October 13, 2021 – ERM Analysis and HNEI Probabilistic Assessment

Full meeting minutes and materials are available on the Company's IGP website:

<https://www.hawaiianelectric.com/clean-energy-hawaii/integrated-grid-planning/stakeholder-engagement/working-groups/stakeholder-technical-documents>

Stakeholder feedback relating to the Renewable Energy Zones Assessment is more fully described in that report. The Company has incorporated the following feedback from the October 6, 2021 STWG meeting include:

- The executive summary should clarify that the REZ study focuses on technical aspects and processes rather than community since the community engagement will happen in a later step
- One stakeholder asked to add a definition of battery energy storage in the report
- Offshore Wind interconnecting through Kahe Power Plant is unlikely
- Evaluate interconnection of 400 MW of offshore wind instead of 600 MW

Future improvements to the REZ analysis that the Company will consider, include:

- Stakeholder suggestions to evaluate which REZ expansions could be most affected by extreme weather events.
- Consider that it's a matter of when not if we will be hit by weather events; therefore, future grid architecture with microgrid capabilities is critical
- Overlay of publicly viewable overhead lines to the maps
- As part of the Grid Needs Assessment, identify projects where a solution may solve multiple needs; for example, upgrading a conductor could facilitate additional renewable energy as well as solve system security issues

### 2.2.3 Additional Stakeholder Feedback in Response to Order No. 37730

In response to Order No. 37730 *Directing Hawaiian Electric to File Revised Forecasts and Assumptions* on April 14, 2021, the Company met with the Parties, Stakeholder Council, and members of the TAP on April 27, 2021 to discuss its current modeling approaches (related to the Grid Needs Assessment) and how it differs from Ulupono's, the tradeoffs between approaches, and which is preferred by the Parties, TAP, and stakeholders.

#### 2.2.3.1 Ulupono's Approach to Modeling

Ulupono's approach to modeling focused on four specific issues.

- Allow RESOLVE to optimize the amount of storage needed for both standalone and paired with solar PV sites, rather than require exactly four hours of storage with utility scale solar



- Use alternatives to the proposed Energy Reserve Margin (“ERM”) calculation or adopt a reserve margin in later years that is tied to a reliability analysis
- Assume batteries and curtailed renewables will be able to provide virtual inertia when needed
- Assume 30 year contracts as the life of the Solar PV system or assume 20-25 with 5-10 year extensions at lower costs

A summary of Hawaiian Electric’s approach, tradeoffs between Ulupono’s and Hawaiian Electric’s approaches, areas of agreement and recommendations are provided below for each of the four issues.

### *Allow RESOLVE to Optimize Paired with Solar Resources*

#### a. Hawaiian Electric’s Approach

In the Company’s model, RESOLVE is allowed to build paired PV and battery systems that are either 4 hour or 6 hour duration as well as standalone storage. Standalone storage is allowed to be optimized for both the capacity (megawatt) and energy (megawatt-hour). Specific durations for paired PV and battery systems are assumed to capture the State Investment Tax Credit (“ITC”) rules more precisely.

To capture the impact of the Federal and State ITC on paired PV and battery systems, the ITCs are assumed to directly reduce the dollar per kW capital costs input into RESOLVE. For a paired PV and battery system, a fixed duration for storage is assumed to capture the cap on the State ITC on a per system basis. One system is defined as 1,000 kW. The ITC is first applied to the PV and any residual tax credit under the cap is then applied to the battery.<sup>13</sup>

#### b. Stakeholder Comments and Tradeoffs

In Ulupono’s approach, without bounding the storage duration for a paired PV and battery system and allowing it to freely optimize, the State ITC may be overstated in the resource’s cost. In Hawaiian Electric’s approach, considering only 4 hour and 6 hour durations may be too rigid and may cause a small amount of excess battery investment.

Other stakeholders recognized that the RESOLVE modeling efforts are intended to identify the grid needs on a technology-neutral basis. The selected resources in RESOLVE serve as a proxy for those needs. Therefore, the current treatment of the State ITC is reasonable. If the ITC is overstated, that might suggest there are more cost-effective resources. Ultimately the RFP and the market will verify the numbers (i.e., price and appropriate duration of storage).

#### c. Areas of Agreement and Recommendations

---

<sup>13</sup> Per HRS § 235-12.5, the cap amount shall be \$500,000 per system for commercial property. See [https://www.capitol.hawaii.gov/hrscurrent/Vol04\\_Ch0201-0257/HRSo235/HRSo235-0012\\_0005.htm](https://www.capitol.hawaii.gov/hrscurrent/Vol04_Ch0201-0257/HRSo235/HRSo235-0012_0005.htm)



Hawaiian Electric and Ulupono both agree that allowing additional paired PV and battery system options in RESOLVE is reasonable.

The recommendation adopted by the Company is to include paired PV with 2 hour, 4 hour, 6 hour, and 8 hour battery systems.

### *Use Alternatives to ERM or Adopt a Reserve Margin that is Tied to a Reliability Analysis*

#### a. Hawaiian Electric's Approach

In the IGP process, the Company introduced a new planning criteria called Energy Reserve Margin ("ERM") to satisfy load and plan for a reasonable reserve that can be called upon in emergencies. The ERM planning criteria considers the total firm system capability that is reduced by planned maintenance and outages and increased by hourly dependable capacity ("HDC") of variable renewable resources, shifted load from energy storage resources, and interruptible load, the sum of which must be greater than the load that is increased by the ERM percentage on an hourly basis. The margin provided by ERM is intended to provide reserves to mitigate:

- Loss of largest unit
- Multiple forced outages
- Unplanned maintenance
- Fluctuations in generation from variable resources
- Prolonged poor weather patterns or atypical weather
- Battery failures
- Forecast error

The ERM targets are 30% for O'ahu, Hawai'i Island, and Maui and 60% for Moloka'i and Lāna'i. The targets were selected by analyzing historical data. As described in Appendix C, various events were studied to examine reserves, loss of largest unit, unit availability, loads, loss of load hours, and frequency of at-risk conditions.

Additional information on the derivation of the ERM targets is included in Appendix C.

#### b. Stakeholder Comments and Tradeoffs

In Ulupono's approach, planning only to include the worst weather day will assume that the worst weather day occurs every year that is simulated and assumes that the worst weather day will also account for unexpected, forced outages or forecast error where load is unexpectedly higher. Ulupono recommends a 7-step process to assess the "optimal" ERM for the system that starts at 0% ERM and increases the ERM percentage until the desired reliability level is reached.



1. Include worst days in time sampling in RESOLVE
2. Count renewables at their full hourly availability in RESOLVE
3. Set initial ERM to 0%
4. Run RESOLVE with current ERM
5. Test the resulting plan with many years of data (e.g., in PLEXOS) – include all possible weather, realistic forecast errors for load and renewables, forced outages for thermal plants and batteries, etc.
6. If shortfalls are found: increase ERM by a few percent and return to step 4
7. Repeat until shortfalls are cleared

Stakeholders felt that in Hawaiian Electric’s approach, the ERM may be too conservative and overbuild capacity. The ERM may also favor thermal units in its derivation because loss of largest unit, multiple forced outages, and unplanned maintenance are implicit thermal unit considerations. Uluono noted that the HDC used to calculate the variable renewable contributions excessively discounts the generation provided by these resources and is not necessary.

A TAP member commented that they support transition away from a planning reserve looking at peak to one that assesses hourly load. For reference, Southern California Edison and Community Choice Aggregators have proposed a similar planning criteria to energy reserve margin that examines all hours. Planning reserve margin focused on system peak was based on resource adequacy and loss of load. To meet the reliability criteria, the system needed X% of margin. It could be interesting to link and correlate traditional metrics such as loss of load expectation (“LOLE”) with ERM. A large driver of the 30% was driven by multiple unit outages. When considering retirement of fossil units, the risk of concurrent outages diminishes.

Another stakeholder liked the idea of linking ERM to LOLE.

#### c. Areas of Agreement and Recommendations

Hawaiian Electric and Uluono agree that further study of the ERM criteria is warranted to determine the appropriate level of reliability that should be solved for in the optimization models.

Hawaiian Electric proposes to test lower percentages (0%, 10%, 20%, 30%) and higher (40%), if applicable for the ERM target in RESOLVE and evaluate the reliability impact on the resulting resource plans in PLEXOS. A sensitivity will also be performed to remove the HDCs and instead consider the full production profiles to evaluate how different treatments of renewable output affect reliability to inform the treatment variable renewables in the Grid Needs Assessment. HNEI will test the reliability of the various resource plans generated from RESOLVE at different ERM levels using their stochastic resource adequacy methodology to compare how LOLE and EUE compare to the deterministic ERM method.

#### d. Additional Follow-up Comments From Uluono





On September 10, 2021, Ulupono submitted reply comments to the August I&A Update. In their comments, Ulupono provided suggestions to improve the process to develop an ERM target and expressed concerns regarding the use of HDCs to define variable renewable capacity contributions. On pages 8-9 of their comments, Ulupono made three additional recommendations:

- a. It would probably be helpful to include N-1 outage criteria in RESOLVE itself, so the model can optimize the selection of large vs. small power plants.
- b. The September 7, 2021 proposal uses 10% steps in the ERM. Once the modeling is underway, it would be useful to evaluate finer steps between the maximum inadequate ERM and the minimum adequate ERM, to more closely identify the correct level.
- c. Hawaiian Electric reported in the September 7, 2021, meeting that they do not plan to include demand response in the ERM calculation. We recommend that demand response (and all other resources) be included in the ERM calculation in the same way that they are included in the day-to-day load balancing (more on this below).

Put another way, the contribution of each resource to generation adequacy each hour is simply the amount of power that it is able to produce in that hour. So the capacity counted toward the ERM requirements during each sample hour should be equal to the production potential during that hour, as already represented in RESOLVE

Instead of using the HDC approach, we recommend that the ERM be modeled in RESOLVE by adding a collection of "ERM" sample days with higher than normal loads, which the model is free to serve using all resources at its disposal.

The Company provided its response to Ulupono's comments on the August I&A Update in its reply comments filed on September 21, 2021, noting that defining adequate reliability could require a high degree of engineering judgement<sup>14</sup> and that the Company will consult the TAP once it has completed its ERM analysis. The Company continued to assert that HDCs are appropriate to characterize the reliable capacity from variable renewable resources as historical weather days may not be fully representative of all possible weather in the future. As mentioned previously by the TAP, the Company reiterated that the RESOLVE model by itself

---

<sup>14</sup> The TAP in its June 1, 2021 Grid Services and Planning Criteria Feedback at pages 5-6:

Several times was emphasized by TAP that reliability is critical and "when we think about reliability, we do not want to be short." This may require prioritizing the near-term over the long-term - because in the near-term we're not able to change things as much. There is a need to think about this issue as "minimums," that are required and then looking at the costs of the alternatives for meeting the minimums. Utilities don't want to get caught short on reliability. While the TAP agreed that there can be advantages to going long and growing into it, it was also pointed out that the frame for utilization of these resources must be carefully considered. This is another area, requiring 'engineering judgement', not just models. (emphasis added)



may not be appropriate to consider the full hourly time series and that reliability analyses are better suited for PLEXOS, consistent with the modeling framework that was agreed to with the TAP.

Regarding Ulupono's suggestion regarding the inclusion of N-1 outage criteria, the Company does impose single point of failure requirements for system security reasons i.e., 135 MW for O'ahu, 20 MW for Maui, and 30 MW for Hawai'i Island. This helps to limit the impact of large units adversely impacting reliability. These limits are balanced with increased cost as smaller size limitations may increase costs for interconnection and economies of scale.

The Company also clarifies that demand response programs are currently being modeled as a supply side resource so they are taken into account as part of the ERM modeling in RESOLVE.

Regarding Ulupono's comments regarding elimination of HDCs, the Company believes that HDCs are appropriate to characterize the reliable capacity from variable renewable resources for long-term capacity expansion modeling. The HDC can serve as a reasonable assessment of reliable variable renewable capacity because the most difficult historical weather days may not represent the renewable energy generating potential on the most difficult weather days in the future and can help to ensure adequate capacity is available to serve load because all possible weather would be difficult to explicitly model.

Ulupono's comments on this topic are focused on the evaluation of all aspects of long-term planning (i.e., resource addition optimizations, reliability, operations, etc.) within a single model like RESOLVE or SWITCH. RESOLVE and similar models do not consider the full time series of resource production due to the model's convention to model representative days that are then weighted to extrapolate to full years.

The Company notes that Ulupono's concerns should be addressed through hourly production simulation model like PLEXOS that can consider each hour of each year of the planning horizon. As discussed at the June 4 Technical Conference and in this report, as part of the modeling framework that was recommended by the TAP in its June 1, 2021 Grid Services and Planning Criteria Feedback at pages 3-6, the modeling framework will have a specific Resource Adequacy step that can assess reliability without the use of HDCs and instead use stochastic analysis on actual production profiles.

Further, in response to TAP feedback to correlate ERM to LOLE and to utilize PLEXOS to assess resource adequacy, Telos Energy conducted an independent reliability assessment<sup>15</sup> for O'ahu and Maui. In their preliminary results for Maui and O'ahu using a stochastic analysis to derive LOLE on the RESOLVE developed capacity expansion plans at different ERM targets, Telos Energy stated, "Based on initial test cases, a 30% ERM proposed by HECO shows a

---

<sup>15</sup> See ERM Calibration and Resource Adequacy presented by Telos Energy on October 13, 2021 at [https://www.hawaiianelectric.com/documents/clean\\_energy\\_hawaii/integrated\\_grid\\_planning/20211013\\_hnei\\_erm\\_stakeholder\\_presentation.pdf](https://www.hawaiianelectric.com/documents/clean_energy_hawaii/integrated_grid_planning/20211013_hnei_erm_stakeholder_presentation.pdf)



reasonable level of reliability – for the current resource mix – when evaluated with more detailed probabilistic assessment.”<sup>16</sup>

In the October 13, 2021 STWG meeting, stakeholders noted it would be helpful to further understand the impact of HDCs on the resulting resource plans and requested the Company evaluate a resource plan using a one sigma PV HDC and evaluate a separate resource plan using the production profiles for variable renewables while still assuming thermal resources are not available as candidate options. The Company conducted a supplemental analysis in RESOLVE to determine the impact of these assumptions on the resource plan. The results of the supplemental analyses are described in Section .o.o.o.

### *Assume batteries and curtailed renewables will be able to provide virtual inertia*

#### a. Hawaiian Electric’s Approach

In the IGP process, the Company proposed minimum inertia and fast frequency response (“FFR”) requirements that are complementary and work together to support system frequency in an under-frequency event. The minimum inertia plans for a 3 Hz per second change of frequency event and to allow 0.5 seconds for FFR to activate. The requirement also considers the loss of the largest generator and the impact of legacy distributed PV trip settings. Inertia requirements based on maintaining 3 Hz per second is a progressive metric as mainland systems will rarely see such fast rate of change of frequency, and historically in Hawai‘i, the rate of change of frequency has been lower/slower than 3 Hz per second. Therefore, the minimum inertia requirements have already been minimized to the extent possible.

#### b. Stakeholder Comments and Tradeoffs

Ulupono recommends the following:

- Make reasonable assumptions for when inertial response will be available from inverters
  - May be available soon based on literature review and recent commercial experience
  - Possibly earlier for grid-scale facilities than DER
- Calculate inertial requirements based on stability studies of power systems with very fast frequency response and virtual inertia from inverters
- Identify near-term, low-cost sources of inertia that can be used until inverter-based inertia is widely available
- Include those assumptions in the RESOLVE modeling
  - The current treatment is arbitrary and likely to result in stranded/unnecessary assets

---

<sup>16</sup> See ERM Calibration and Resource Adequacy presented by Telos Energy on October 13, 2021 at [https://www.hawaiianelectric.com/documents/clean\\_energy\\_hawaii/integrated\\_grid\\_planning/20211013\\_hnei\\_erm\\_stakeholder\\_presentation.pdf](https://www.hawaiianelectric.com/documents/clean_energy_hawaii/integrated_grid_planning/20211013_hnei_erm_stakeholder_presentation.pdf)



In Uluono's approach, virtual inertia, or specifically, grid forming inverters are promising; however, requirements for grid forming inverters are still being studied. Many questions remain concerning the use of grid forming inverters and are current areas of research. However, Uluono states that the Company should assume there will be progress within the planning horizon of IGP and that inertia and frequency response should be provided by a reasonable source, which will likely be inverters in the long term plans. Uluono does not object to the use of synchronous condensers for other critical services such as system protection and fault current, only to omitting inverter response which may reduce the needs for synchronous condensers.

A stakeholder for a large customer mentioned that they have concerns regarding protection. The amount of inverter based short circuit current may cause significant cost and possible reduced reliability. Other customers with large campuses or facilities would need to adapt their protection.

c. Areas of Agreement and Recommendations

Hawaiian Electric and Uluono agree that further study of the provision of virtual inertia is warranted, that the inertia assumption in RESOLVE is directional only, and that the detailed requirements will be determined through stability studies using other software tools such as PSS/E and PSCAD.

Hawaiian Electric proposes that model testing be performed in RESOLVE to assess the cost and impact on the resource plan where batteries and curtailed renewables can provide inertia in the model. See Section 3.3.3, for further details on the model testing and the Company's recommendation on this issue.

To mitigate near-term stability issues, where inverter-based resources are expected to make up 95-100% of the dispatched resources for certain hours of the year in 2023-2025, the Company will minimize synchronous condenser investments to the extent possible based on stability studies in PSS/E and PSCAD and repurposing of generation assets to synchronous condensers to minimize costs.

d. Additional Follow-up Comments From Uluono

On September 10, 2021, Uluono submitted reply comments to the August I&A Update, where they agreed with the Company's decision to remove the inertia and FFR requirement from RESOLVE based on the model testing described in Section 3.3.3. The Company also clarified in its Reply Comments on September 21, 2021 page 32, that instead FFR and inertia needs will be assessed as part of the system security simulations at the end of the process. If the stability criteria is not met, the prior production simulations or capacity expansion modeling will be adjusted to address any grid service shortfalls.



### *Assume 30 year contracts as the life of the Solar PV system*

#### a. Hawaiian Electric's Approach

In the IGP process, the power purchase agreements ("PPAs") signed with independent power producers ("IPPs") were assumed to terminate at the end of the contract term to allow the RESOLVE model to re-optimize grid needs when contracts end. New PV and wind resources were assumed to have 20 year term lengths, consistent with the recent Stage 1 and 2 RFP projects.

#### b. Stakeholder Comments and Tradeoffs

Assuming Ulupono's preference for 30-year contracts, extending existing IPPs may not allow the RESOLVE model to re-optimize in the future when grid needs have changed. Assuming Hawaiian Electric's approach to end PPAs at the end of their term, there could be missed opportunities from extensions of existing IPPs that could be lower cost than requiring a new resource to be built. For new resources, longer contract terms, from 20 years to 30 years, would allow for a lower contract cost and to better match the contract term to the expected service life of the resource. Ulupono asserted that when an existing IPP reaches the end of its 20-year contract, the Company may not receive significantly lower pricing if the contract were renegotiated for another 10 years.

Stakeholder commented that the market provides financing for solar and storage projects over 35-40 year terms. Also, assuming battery warranties were 15 years, within a 20-year contract, the batteries would be replaced in year 15 and still have 10 years of life remaining when the 20-year contract ends.

Another stakeholder did not favor long-term contracts because it may prevent customers from realizing the benefits of declining technology costs.

A stakeholder commented that asking communities to host longer term projects at 40 year terms may potentially span 3 generations.

#### c. Areas of Agreement and Recommendations

For long-term planning purposes, Hawaiian Electric and Ulupono agree that new PV and wind resources can assume a 30 year term. Stage 1 and 2 RFP projects will also be extended at their current lump sum costs for a total term of 30 years. Existing PV and wind resources will continue to be removed from service at the end of the contract term.

### 2.2.4 Additional Stakeholder Feedback Received on the Grid Needs Assessment Report

On August 22<sup>nd</sup>, the Company emailed an updated Grid Needs Assessment Methodology report that updated the March 2021 version posted to the Company website subsequent to the



concluding of the SEOWG meetings. A clean and redlined copy compared to the March 2021 version was provided for review. Stakeholders were provided until September 14, 2021, later extended until September 24, 2021 to provide comments.

The Company received comments from Progression, Blue Planet, and Commission Staff. Many of the questions revolved around clarifications, which the Company has made appropriate edits throughout this document to address questions or issues raised.

### 2.2.5 Technical Advisory Panel Review of Grid Needs Assessment Methods and Criteria

The Technical Advisory Panel's primary purpose is to provide independent technical peer review of IGP methods, tools, and analysis.

It was recognized early on that IGP would require learning from and keeping pace with innovations from elsewhere. A standing independent industry group of experts participating from internationally recognized utilities, market operators, and research organizations was formed in June 2018 to provide independent peer assessment or evaluation, including input and feedback of the IGP development process, methodologies, tools, and results. The TAP is explicitly not a decision-making body.

TAP members participate in meetings held regularly, in person and via webinar, aligned to key process milestones as well as review materials as requested by Hawaiian Electric, stakeholder working group and Stakeholder Council. This requires TAP members to take an active role in analyzing, evaluating, and providing public technically oriented feedback on stakeholder working group input and various technical filings by Hawaiian Electric.

The TAP does not produce engineering and economic analyses itself, but may recommend specific analyses be undertaken by Hawaiian Electric or independently through other entities. Also, the TAP does not perform evaluations of sourcing or procurements but may provide feedback on the methods and processes that Hawaiian Electric uses to perform such work. The procurement and associated evaluation process is overseen by an independent observer.

A TAP Chair is also selected on a 2-year rotational basis. The Chair, in coordination with Hawaiian Electric, develops meeting agendas to shape discussions, develop meeting summaries, and disseminate information to the other TAP members, the Stakeholder Council, and the public. The TAP Chair is a member of the Stakeholder Council to facilitate two-way communication between the two groups.

Full documentation of the TAP's independent review of the various methodologies and planning criteria to be used in the Grid Needs Assessment, are included in Appendix K.

#### 2.2.5.1 Review of Ulupono Initiative's Suggested Modeling Methods

As discussed in Section 2.2.3.1, there were four modeling methods suggested by Ulupono. The Company discussed Ulupono's recommendations with the STWG, and reached agreement on ways to modify its modeling methods that incorporated suggestions by Ulupono. The TAP's



review of these recommendations were filed in the IGP proceeding on June 1, 2021, and also provided in Appendix E.

In its review of the recommendation to allow RESOLVE to add PV paired with varying durations of battery energy storage (2-, 4-, 6-, or 8-hour duration), the TAP agreed that using RESOLVE to estimate the optimal energy storage size should be conducted. The TAP noted that RESOLVE should not be the sole determinant for the optimal storage duration. Consistent with the modeling framework discussed in Section 3, the other steps in the modeling process must also evaluate the appropriateness of storage. For example, using energy storage for resource adequacy must be evaluated using PLEXOS in the resource adequacy step.

In its review of the recommendation to conduct further analysis to determine an appropriate energy reserve margin for long-term planning, the TAP agreed that Hawaiian Electric is correct to identify a need to change the conventional planning reserve margin to one that evaluates all hours of the year. The TAP recognized that capacity planning models require some 'relatively simple' methodologies to address the many issues impacting reliability, and agreed ERM is a reasonable approach to take. However, more clarity is needed on how the specific ERM values were derived. Therefore, the TAP recommended that a more complete description of the determination of the current ERM values be developed and made available for review, and analysis be conducted to determine the relationship between ERM and detailed resource adequacy analysis. Regarding a more complete description of the current ERM values, the Company has provided additional information in Appendix C.

Regarding the second recommendation to determine the relationship between ERM and resource adequacy analysis, the TAP generally agreed with the Company's recommendation to use RESOLVE and PLEXOS to develop resource portfolios associated with different levels of ERM (i.e., 0%, 10%, 20, 30%, etc.). As part of that analysis, a probabilistic resource adequacy assessment could be quantified using metrics such as loss of load expectation, expected unserved energy, among others. The TAP through HNEI also conducted their own analysis to determine the relationship between ERM and traditional reliability metrics (i.e., LOLE). A report of the Company's additional analysis on ERM is included in Appendix C.

The TAP did not agree with Ulupono's statement to "[i]nclude[ing] the worst-weather day in the RESOLVE optimization will ensure that the system has a least-cost design that provides enough power at all times. Consequently, it is not appropriate to apply an ERM as an additional, arbitrary mechanism to achieve generation adequacy". The TAP emphasized that determining the cost-effective, reliable path forward requires use of all the tools identified in the modeling framework.

Finally, the TAP reviewed Ulupono's suggestion to assume batteries and curtailed renewable will be able to provide "virtual" inertia. The TAP acknowledges that in the near future inverters providing services such as inertia and/or FFR will become available; however, a major question remains as to how this would be implemented. For example, system operators need to be able to implement this capability from inverters in a controllable and coordinated way. The TAP





sees high risk in relying exclusively on inverters (i.e., with no synchronous machines) for inertia at this time. The TAP noted that the forthcoming years should allow the Company to gain experience with inverters providing a type of inertial response alongside synchronous machines. In the interim the TAP felt synchronous condenser conversions were a reasonable and realistic short-term bridge as inverter technology matures. As discussed in Section 3.3.3, based on Ulupono's recommendations, the Company will disable the inertia constraint in RESOLVE and rely upon the system security analysis to determine inertia needs.

## 2.2.6 Community Engagement for Project Development

The Stakeholder Council, taking on a strategic advisory role to the Company on IGP matters, met on March 9, 2021, March 29, 2021, and April 27, 2021, to discuss how to improve community engagement for project success. In the following section, outlined are the key takeaways from those discussions.

### 2.2.6.1 Key Takeaways from Stakeholder Council

- Three branches that need public participation, input, and guidance: Hawaiian Electric, PUC, and developers. Public participation is also needed from other key stakeholders, such as the Hawaii State Energy Office.
- The Company should raise the "floor" of stakeholder engagement – define and raise the bar for minimum requirements of successful engagement.
- Customization – Each community is unique with different interests. Listen to better understand each community's needs and priorities. For example, one community may be concerned about agriculture. Another community may be interested in education and job creation for the community related to the renewable project.
- PUC has a role to play in soliciting community input – needs to be more open and accessible to the public and provide public notice of dockets outside of the current process, such as through news releases; needs to solicit input on RFPs versus only at the end when projects are already selected.
- Be more aggressive in soliciting input during RFP development: newspapers, website, social media, neighborhood newsletters, etc. – broaden the type of stakeholders that provide input not just energy "insiders" that are involved in the industry on a day-to-day basis.
- Consider "co-design" concepts in RFP development similar to what was done on Moloka'i.<sup>17</sup> Start the engagement process in Step 1 not Step 5.
- Identifying available sites for development (i.e., Land RFI) and working with neighborhoods and communities on siting projects there prior to RFP issuance.
- Consider non-bid criteria that considers number and type of projects in the same area.

---

<sup>17</sup> See

[https://www.hawaiianelectric.com/documents/clean\\_energy\\_hawaii/selling\\_power\\_to\\_the\\_utility/competitive\\_bidding/docket\\_2019-0178.pdf](https://www.hawaiianelectric.com/documents/clean_energy_hawaii/selling_power_to_the_utility/competitive_bidding/docket_2019-0178.pdf)





- Consider input that distinguishes long term vs short term project development. Allow stakeholders to give developers a chance to study a long-term project versus simply asking whether they like the project or not.
- Better demonstration to communities how feedback is being considered.
- Make it easier to receive feedback without intervention (costly)

#### 2.2.6.2 Specific Recommendations and Changes to Make to the Overall Process

The Company will continue to evaluate and develop broader community engagement plans and intends to present those plans at the appropriate time. The Company believes, and agrees with stakeholders, that early community engagement is one of the elements that contribute to a successful project. The following provides high-level recommendations based on the Stakeholder Council discussions.

##### Pre-RFP Phase

- If the Grid Needs indicate the potential project locations are in a particular area, some Company engagement can be done by the Company ahead of the issuance of a draft RFP.
- Make materials with best practices and community contacts tailored to each island or community available to potential developers ahead of RFP.
- Work with the PUC to allow for more public awareness and participation in the RFP design process.

##### RFP Phase (and Model PPA)

- Establish metrics for proposers to demonstrate success of Community Engagement Plan after being selected to Final Award Group.
  - Documentation validating responses to community questions/concerns, and requests for information, updates, and follow-up presentations, as well as documentation on how feedback is being considered.
  - These metrics would not be an evaluation tool, as they are post selection, but could be used to validate to the PUC and stakeholders that developers are meeting the RFP and PPA requirements for selected proposers.

##### Post-RFP, Post-Project Award Phase

- Apply metrics requirement from RFP for developers to demonstrate commitment to community engagement throughout all phases of the project.
  - (From above RFP Phase) Documentation validating responses to community questions/concerns, and requests for information, updates, and follow-up presentations, as well as documentation on how feedback is being considered.
  - E.g., updates to community organizations, elected officials.



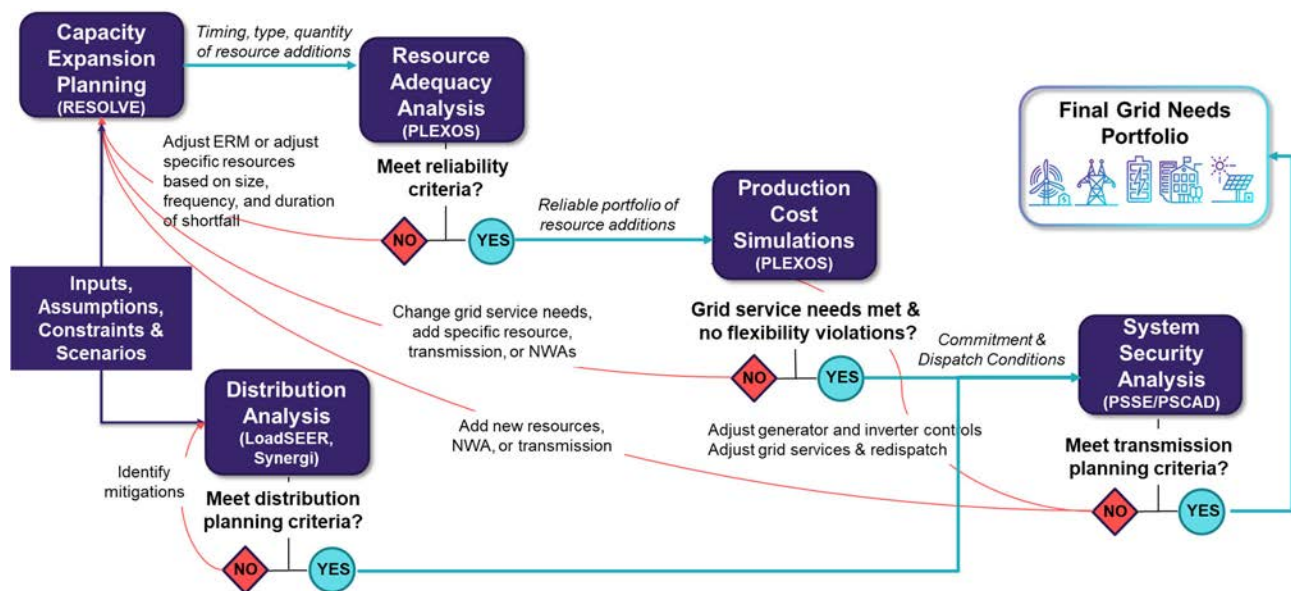
# 3 Grid Needs Assessment Methodology

## 3.1 OVERVIEW & PURPOSE OF MODELING TOOLS

The intent of the modeling objectives and characteristics described herein is to provide a transparent and detailed view of the steps needed to identify the Grid Needs for the Integrated Grid Planning process, as well as the evaluation and optimization of solutions sourced through the Grid Needs procurement.

Through engagement with Hawaii Natural Energy Institute (“HNEI”) and the Technical Advisory Panel, the Company established a modeling framework for the Grid Needs Assessment methodology. Hawaiian Electric adapted the framework presented by HNEI, as shown in Figure 3-1.

Figure 3-1: Grid Needs Assessment Modeling Framework (Adapted from HNEI)



Two models used to identify and verify the Grid Needs are the RESOLVE model and the PLEXOS model. RESOLVE produces a proposed optimized resource plan of proxy resources that can fulfill the Grid Needs. The primary objective of this phase of the process is to identify Grid Needs using proxy resources; the actual resource and action plans will be determined subsequent to the solution sourcing step which would define the actual technology or resources that are able to meet the identified Grid Needs. In other words, the Grid Needs Assessment is not intended to select or express a preference for a technology; rather identify what is needed for the system and allow the market to propose solutions to meet those needs. In addition to the RESOLVE base case that is developed using a base set of planning assumptions, further sensitivities will be run in RESOLVE to stress test the key inputs and



assumptions with the intent to better understand how certain assumptions influence outcomes and to the extent possible formulate an action plan with least regrets. The additional sensitivities are outlined in the August I&A Update.

Once the results of the RESOLVE sensitivities are incorporated into the base case, the reliability of the resource plan is then evaluated in PLEXOS to assess Resource Adequacy. Next, the operations of the resource plan is verified through an hourly production simulation to ensure that the Grid Needs continue to be met on an 8760 hourly basis and to more accurately capture the annual total system costs than the directional costs captured by RESOLVE based on the 30 representative sample days. The results of the production simulation in PLEXOS are then used as inputs into the System Security analysis. The System Security analysis will be completed in PSS/E, PSCAD, and/or ASPEN Oneliner to evaluate needs for short circuit current, inertia, frequency response, voltage support, and assess inverter control interactions, weak grid/system strength issues. If the System Security step (or any of the other steps) identifies any shortfalls in the Grid Needs, the resource plan may be iterated upon to meet those residual needs. To address shortfalls in the Grid Needs, the proxy resources identified in the resource plan may be increased or accelerated from future years.

---

## 3.2 MODELING FRAMEWORK

Each step in the modeling framework has a different objective. As the TAP noted, the full suite of modeling tools should be utilized in assessing the Grid Needs. For example, in its independent review, the TAP stated:<sup>18</sup>

RESOLVE provides limited fidelity and should be used only as a technology screening tool. Subsequent determination of reliability, analysis of multi-year weather data, retirements, and avoided costs, etc. requires the use of other modeling tools. It was emphasized more than once that the other models should be an integral part of the overall process, NOT just a check on the output from RESOLVE.

Figure 3-2 describes an overview of the objectives, key inputs, and outputs of each modeling step and tool. Each modeling software tool is described in the following sections, including a discussion of when adjustments or iterations may be made in each step. These decisions cannot be quantified by a set of criteria. Typically, planners will use engineering judgment when making decisions to adjust or iterate a modeling step. Adjustments or iterations could include a decision on whether a shortfall in capacity to meet reliability criteria is needed. On this issue, the Company posed the following questions to the TAP: What is the level of tolerance to decide when to go back and iterate and is it necessary to always rerun the full process or can estimations serve to backfill shortfalls? The TAP's response is summarized below.

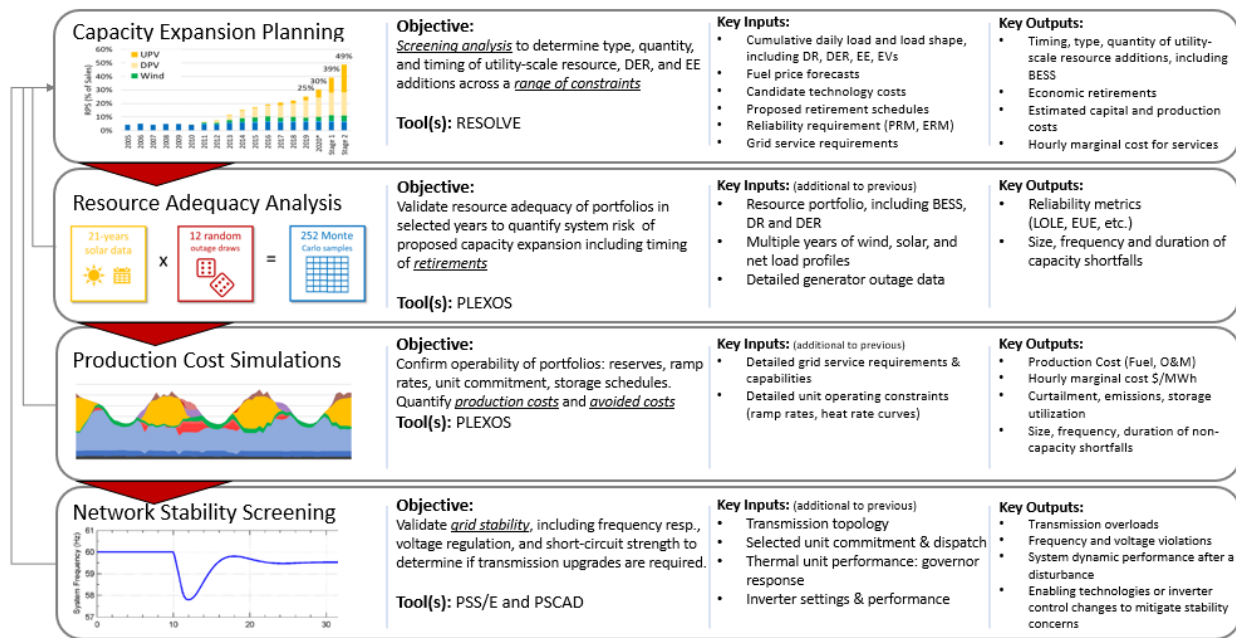
---

<sup>18</sup> See Grid Services and Planning Criteria Feedback filed in Docket No. 2018-1065 on June 1, 2021 at 4.



TAP did not provide a hard and fast answer to these questions, noting the need for ‘engineering judgment’ and ‘experience’ to determine what needs to be done. While TAP recognizes that engineering judgment can reduce the requirement for the full process to be used for all iterations, TAP recommends that solutions be vetted by the full process before proceeding to the procurement phase.<sup>19</sup>

Figure 3–2: Key Inputs and Outputs of Modeling Steps



As part of the Grid Needs Assessment and stakeholder process, the Company intends to be as transparent as possible in making decisions on adjustments or iterations. The Company intends to share the results of its modeling with stakeholders through its various stakeholder engagement groups, during which there will be opportunities for discussion and feedback. Through these discussions, the Company will decide whether additional iterations are needed and how the results of the various cases can inform modifications to the base case assumptions to carry forward through the process. For example, the Company may share the modeling results of the bookend cases in RESOLVE and other sensitivities listed in the August I&A Update for review and feedback. Based on stakeholder feedback, this may result in adjustments to sensitivities or warrant an iteration of a particular sensitivity. The Company will present the stakeholder feedback as well as the Company’s recommendations to the TAP for their review and recommendations on any iterations necessary.

Ultimately this process will inform the selection of the top or preferred portfolio(s) to move onto the Resource Adequacy and Production Cost Simulation steps to be run in PLEXOS. The same review with stakeholders and TAP can take place before moving on the System Security step. At this time the Company has allotted six months for the total Grid Needs Assessment

<sup>19</sup> *Id.* at 4.



step, which is a compressed schedule for the scope of work and stakeholder engagement necessary. For this process to be effective and streamlined, the Company will require timely engagement of all interested stakeholders. The Company notes during this modeling review process, iterations may include changes or tweaks to modeling parameters but not changes to cost projections, forecasts, or changes that would cause additional analysis to create a new input or assumption; the bookend scenarios should be relied upon to inform what-if type of scenarios and uncertainties.

### 3.2.1 Capacity Expansion (RESOLVE)

The RESOLVE modeling software will be used to perform the capacity expansion step. RESOLVE identifies potential least cost portfolios that meet RPS requirements based on a user defined reliability requirement such as Energy Reserve Margin (“ERM”) and regulating reserve.

RESOLVE evaluates 30 representative days, using a statistical sampling to downscale annual data to 30 representative days per year. These representative days are weighted based on historical data to capture operational costs under most conditions. In addition to the day sampling, resources with similar operating characteristics are aggregated to facilitate efficient solving for the optimized portfolio. Each day is evaluated in isolation (no multi-day analysis) with limited capability to determine if a portfolio is operable or reliable.

The detailed inputs into the RESOLVE model are provided in the August 2021 I&A Update, that consists of load shapes for distributed energy resources, energy efficiency, electric vehicles, fuel price forecasts, technology cost projections, proposed retirement schedules and grid service requirements, including energy reserve margin. When considering the impact of these assumptions on the RESOLVE model outputs, it is important to note the range of load and load shapes, not individual layers, is most important to bookending the Grid Needs.

The primary outputs from RESOLVE, include the timing, type, and quantity of resource additions to enable generating unit retirements and compliance with RPS and other grid service requirements.

The Company is engaged with the TAP to review its approach to capacity planning and its implementation in the RESOLVE model through the ERM criteria. The Company’s proposal to move forward with the capacity expansion analyses in RESOLVE for this first cycle of IGP are described below. Further supporting documentation of the Company’s analyses to define an appropriate ERM can be found in Appendix C.

- For the purposes of capacity expansion planning in the RESOLVE model, the Company recommends using the ERM methodology as previously described, with ERM targets



validated by the TAP,<sup>20</sup> and HDC's validated by supplemental testing. (e.g., 30% ERM target for O'ahu, Hawai'i Island, and Maui and 60% ERM target for Moloka'i and Lāna'i, and 2 sigma PV and 1 sigma wind HDCs)

- The 30% / 60% ERM targets were initially based on providing replacement energy for the loss of the largest unit on each island. The 30% targets were then validated and deemed reasonable based on independent analyses conducted by HNEI and Telos Energy.
- Regarding the use of HDCs (2-sigma for PV and 1-sigma for Wind), the Company tested 30% ERM on O'ahu for year 2030 using the proposed HDCs, substituting 1-sigma for PV, and replacing HDC with production profiles for wind and PV. In all 3 cases, the Company removed 387 MW of existing firm thermal capacity from the system (simulating a year 2030 case). The resource plans developed by the RESOLVE model did not result in any significant overbuilding when confirmed in the ERM test and production simulation conducted in PLEXOS. In the 2-sigma PV, 1-sigma wind case, RESOLVE built a new 57 MW firm capacity generator. In the 1-sigma PV and production profile case the model chose not to build the 57 MW of firm capacity. Having an additional 57 MW of firm capacity is relatively marginal given the size of the O'ahu system and may provide additional resilience benefits to customers that can serve the grid during an emergency situation (i.e., natural disasters damaging solar or wind plants, prolonged poor weather, etc.).
- The results for O'ahu described here are indicative of the results for Hawai'i Island, Maui, Moloka'i, and Lāna'i and in line with independent verification of the ERM conducted by Telos Energy for O'ahu and Maui.
- Further evaluation of the ERM with higher levels of variable renewables on the system is recommended once operational performance is realized, and real operational experience is gained with the hybrid solar and storage plants that are expected to come online in the next few years. Fundamentally, reliability analysis assesses the risk of having sufficient generating resources to meet customer demand. Using the recommended approach by the Company for the first IGP cycle appropriately mitigates the risk of uncertainty of variable renewable contribution to demand at each hour of the year. As the first cycle of IGP is expected to focus on the next 5-10 year action plan there will be opportunities to make adjustments over the next 10-20 years when such operational experience is collected. In other words, using the approach proposed for this first IGP cycle does not crowd out future opportunities or the Company's ability to accelerate other generating unit retirements should operational experience allow us to do so.

However, if the Commission is inclined to not adopt the Company's ERM and/or HDC recommendation for use in RESOLVE for this first IGP cycle, then the Company proposes the

---

<sup>20</sup> See Telos Energy recommendations at pages 7, 9-10, [https://www.hawaiianelectric.com/documents/clean\\_energy\\_hawaii/integrated\\_grid\\_planning/stakeholder\\_engagement/technical\\_advisory\\_panel/20211101\\_tap\\_hnei\\_grid\\_integration\\_erm\\_calibration.pdf](https://www.hawaiianelectric.com/documents/clean_energy_hawaii/integrated_grid_planning/stakeholder_engagement/technical_advisory_panel/20211101_tap_hnei_grid_integration_erm_calibration.pdf).





following alternative to further analyze HDCs directly in line with the TAP's recommendations for this first IGP cycle. However, additional time will be needed to complete the additional analysis. This alternative method relies upon simulated data to characterize the capacity value of variable renewables in lieu of actual production or the appropriate margins to mitigate errors in simulated data. Should real operational performance of existing variable renewables and new hybrid solar and storage plants prove that their calculated capacity values are overstated, the planning criteria may be violated and retirement of fossil generation may be delayed or an expedited procurement of new resources for reliability and capacity needs may be triggered.

- Evaluate alternative calculations for the HDC
  - The TAP expressed a desire to improve data availability for the variable renewable production using simulated data provided by NREL, given that the Company's historical records are limited.
  - An alternate HDC will be developed using simulated NREL weather data to expand the available dataset used in its calculation. The calculation method of this HDC will be as previously described.
  - The hourly production will be considered directly in the HDC calculation because the NREL weather data includes several years' worth of data. Although the TAP suggested a monthly like-hour approach to group hourly data, it will not need to be used to increase the number of available data points since the larger NREL simulated data set is being used.
  - The HDC will be expressed in terms of exceedance probability rather than standard deviation deductions. The effects of varying statistical confidence intervals on the available variable renewable production potential will be evaluated comparing exceedance probability vs actual production.
  - Varying confidence intervals will be evaluated against historical prolonged or extreme weather events that had low wind or solar output to mitigate or account for risk associated with poor weather that would cause low solar or wind output.
  - Improvements to accuracy, data quality, and methodology that impact the dependable capacity estimates of wind and solar as described above may be recommended for use as HDCs in RESOLVE.

### 3.2.2 Resource Adequacy (PLEXOS)

The PLEXOS modeling software will be used to complete the detailed reliability assessment. At minimum, the Company will assess the Grid Needs plan from RESOLVE to determine whether the energy reserve margin criteria is satisfied over the planning horizon. The use of PLEXOS in this step is also the appropriate place to assess reliability for worst days rather than including a worst day in the RESOLVE representative days as suggested by Ulupono. PLEXOS' strength includes analyzing hourly data and simulations that account for weather variability.



A stochastic analysis will be performed for the base plan and potential key sensitivities in key critical years to quantify if a portfolio meets a reliability criterion across every hour of the year analyzed. The reliability metrics that the Company could assess, consistent with analyses performed by HNEI and Telos Energy are:

- Loss of Load Expectation (LOLE)
- Expected Unserved Energy (EUE)

The Company has traditionally used an annual loss of load probability consideration when assessing Adequacy of Supply on O'ahu that is equivalent to loss of load 4.5 years per day. There are no LOLP considerations for the other island service territories. The Company is not establishing an LOLE or EUE reliability planning criteria as part of IGP. Rather the Resource Adequacy step could assess LOLE and EUE of different plans relative to one another in order to provide insight into the relative reliability of different resource plans. On the U.S. mainland a 1 in 10 year LOLE criteria is most commonly used.

Detailed stochastic analyses are more critical in evaluating near-term reliability; however, over longer-term horizons, the larger uncertainty in the underlying forecasts makes detailed stochastic analyses less critical.

The stochastic analysis incorporates wind, solar, and net load variability, and random generator outages to determine probability of unserved load. Typically, simplifications of grid operations for generating and other unit properties are assumed for these types of analyses.

Outputs from a detailed reliability analysis may include, size, frequency, and duration of capacity shortfall, which may be used to adjust or iterate the reliability requirement or adjust resource mix derived from the capacity expansion plan. These outputs are captured in the reliability metrics proposed for this assessment.

The Company is engaged with the TAP to review its approach to determining the reliability of the resource plans that result from the RESOLVE models. The Company's proposal to move forward with the resource adequacy analyses in PLEXOS for this first cycle of IGP are described below. Further supporting documentation of the Company's analyses to conduct its resource adequacy analyses can be found in Appendix C.

#### Resource Adequacy Analyses and Validation in PLEXOS

- Conduct a resource adequacy evaluation utilizing the hourly chronological PLEXOS model and probabilistic modeling techniques in selected plan years
  - Telos Energy noted that while ERM can be used in RESOLVE, a resource adequacy back check is still needed to confirm the reliability of the resource portfolio.<sup>21</sup> Per the IGP modeling framework in Figure 3-1, this would entail developing a resource plan in RESOLVE and evaluating the reliability of the

---

<sup>21</sup> See Telos Energy recommendations at pages at 10.





resulting plan in PLEXOS, with the understanding that the RESOLVE model cannot be used to solve for all situations and other tools should be integrated into the overall process.<sup>22</sup>

- The TAP recognized that resource adequacy evaluation methods using probabilistic modeling can be used to validate the deterministic approach to develop long term plans.
- Calculate unserved energy, unserved energy hours, LOLE, and effective ERM metrics for the evaluated resource plan
- Include the probabilistic modeling of forced outages for thermal units and weather years for variable renewable production
  - Initial comments from the TAP provided in the TAP Resource Adequacy Subgroup meeting on November 1, 2021 indicated that several stakeholders endorsed the probabilistic methodology utilized by Telos Energy to test multiple weather years for variable renewable production and multiple forced outage patterns for thermal units.
- Include the probabilistic modeling of forced outages for battery energy storage systems
  - Recognizing that storage resources may not exhibit perfect availability in actual implementation due to equipment failures,<sup>23</sup> an estimated nominal forced outage rate will be included to reflect an amount of unavailability. Grid-scale load shifting batteries are new to the electric utility industry and do not have a long track record of operations. Therefore, a forced outage rate based on operational experience is difficult to calculate in the near term so a nominal value such as 10% can be used initially until the industry gains sufficient experience to predict the reliability of battery storage systems.
  - In the November 1, 2021 TAP Resource Adequacy Subgroup meeting, the TAP commented on the usage of mature vs. immature forced outage rates or including a longer mean time to repair as a consideration for hybrid plant outages.

### 3.2.3 Production Cost Simulations (PLEXOS)

The PLEXOS modeling software will also be used to perform Production Cost Simulations. The objective of the production cost simulation is to confirm operability of the portfolios by modeling operation of the electric system while accounting for regulating reserves, ramp rates, unit commitment, and storage charging and discharging through economic dispatch. Total

---

<sup>22</sup> Grid Services and Planning Criteria Feedback filed on June 1, 2021 in Docket No. 2018-0165 at 4 and 10.

<sup>23</sup> While typical battery outages are expected to be a fraction of the total capacity for maintenance due to the modular nature of battery storage systems; there have been recent whole battery plant failures that warrant considering the availability of the battery. For example, <https://www.reuters.com/world/asia-pacific/fire-breaks-out-tesla-australia-mega-battery-during-testing-2021-07-30/>, <https://www.utilitydive.com/news/vistras-300-mw-moss-landing-storage-facility-remains-offline-after-overheating/606178/>, and <https://www.azcentral.com/story/money/business/energy/2019/04/23/arizona-public-service-provides-update-investigation-battery-fire-aps-surprise/3540437002/>



production costs and avoided costs are quantitative outputs of the production cost simulations.

PLEXOS will determine if a portfolio is operable on an hourly basis for every day of the year over the planning horizon. The detailed inputs in the PLEXOS model are provided in the August I&A Update and include full 8760 hourly profiles unlike the 30 sampled days per year that RESOLVE uses. Additionally, operating characteristics are modeled with greater detail, for example, heat rate and ramp rate constraints, among others.

The production simulation yields high-fidelity representation of unit characteristics, grid services, system constraints, and more granular costs. Operating violations can be used to adjust or iterate reliability requirement and grid service needs for RESOLVE or specific resource changes.

### 3.2.4 System Security Analysis

To perform the system security analysis, multiple transmission planning modeling software tools are used, including, PSS/E, PSCAD, and ASPEN Oneliner. PSS/E is used to perform steady state power flow and dynamic stability analyses. PSCAD is an electromagnetic transient software that is able to model low inertia grids and inverter-based control interactions in short timescales.

The outputs of the production cost simulations serve as the basis for the resource mix and dispatch scenarios to be evaluated for system security. The analysis evaluates frequency and voltage stability across selected dispatch conditions, and system capacity for load and generation growth. If violations of the transmission planning criteria are found, including if the system is unstable, adjustments or iterations to the system's operations may be made in the production cost simulation assumptions. Aside from operational mitigations, other mitigation options may include the additions of enabling technologies, such as synchronous condensers, updating performance requirements for both grid scale inverters and customer sited inverters, or other changes to inverter settings. Section 3.2.4 describes additional details regarding the System Security analysis.

### 3.2.5 Distribution System Analysis

The distribution system analysis step will primarily use two different modeling tools: (1) LoadSEER, an agent-based forecasting engine, and (2) Synergi software, a steady-state distribution power flow modeling tool.

LoadSEER has been adopted by the Company as a key component to advancing the distribution planning methodology. This electric load forecasting software uses the Company's corporate load forecasts and a multitude of other inputs to create forecasts at the circuit and transformer level.



The objective of LoadSEER is to statistically represent the geographic, economic, and weather diversity across a utility's service territory, and to use that information to forecast how circuit- and transformer-level hourly load profiles will change over the next 30 years. Because of the complexity of the forecasting challenge, LoadSEER employs multiple statistical methods, including hourly load modeling, macro-economic modeling, customer-level economic modeling, and geospatial agent-based modeling, which taken together increase the validity and reduce uncertainty associated with the forecasts.

The bottom-up parcel level methodology used by LoadSEER is aligned with corporate-level forecasts, such that stakeholders are assured that these scenarios are grounded in a shared vision of the service territory, in aggregate. Planners can generate bottom-up scenarios (*i.e.*, high and low bookends) constrained to not exceed the corporate forecast scenarios provided by the corporate level forecasts.

Hourly customer class and feeder load shapes, distribution energy resource ("DER") shapes, and DER forecasts are jointly overlaid within the base load and agent model growth to derive the overall forecast load profile for each circuit, such that all resource and load factors contributing to the circuit's load at risk can be accurately assessed.

These bottom-up simulations provide engineers with circuit-by-circuit forecast. The circuit level data is then readily aggregated up to the transformer and substation levels, but the distribution planner has an important role to evaluate the reasonableness of each forecast within the planner's narrower feeder or bank contexts. This consistent quality-assurance element provides engineering oversight of local knowledge to fine tune the model. This helps guarantee the scenario forecast's quality and usability.

The Synergi modeling tool is a steady-state power flow software that is able to model each distribution substation and circuit. Although the secondary wires are not included in the model, behind the meter customer assets such as rooftop solar and battery energy storage are modeled and aggregated at the distribution service transformer. The Synergi tool is primarily used to assess circuit-level hosting capacity utilizing the circuit-level DER forecasts generated by LoadSEER. Synergi then determines the hosting capacity of each circuit given a DER forecast. If a distribution planning criterion is violated, then Synergi can be used to identify mitigations to allow integration of a desired level of DER.

Stochastic and probabilistic methods are employed to identify the circuit level hosting capacity grid needs. More detail on these methods can be found in the *Distribution DER Hosting Capacity Grid Needs*, November 2021 Update report filed in Docket No. 2018-0165 on November 5, 2021.



---

### 3.3 TRANSMISSION NEEDS

Transmission Needs will be analyzed by the applicable system models. Identified needs, as described in this section, include the following transmission grid services:

- Inertia
- Voltage support
- Fast frequency response (FFR)
- Primary frequency response (PFR)
- Short-circuit current
- Transmission Capacity

There are two major components to inform transmission needs – system security analysis and Renewable Energy Zone (REZ) study, which will be guided by the Transmission Planning Criteria for each island described in Appendix F. The TAP conducted a review of the Transmission Planning Criteria and the System Security process. Their recommendations and feedback that was incorporated by the Company can be found in Appendix K.

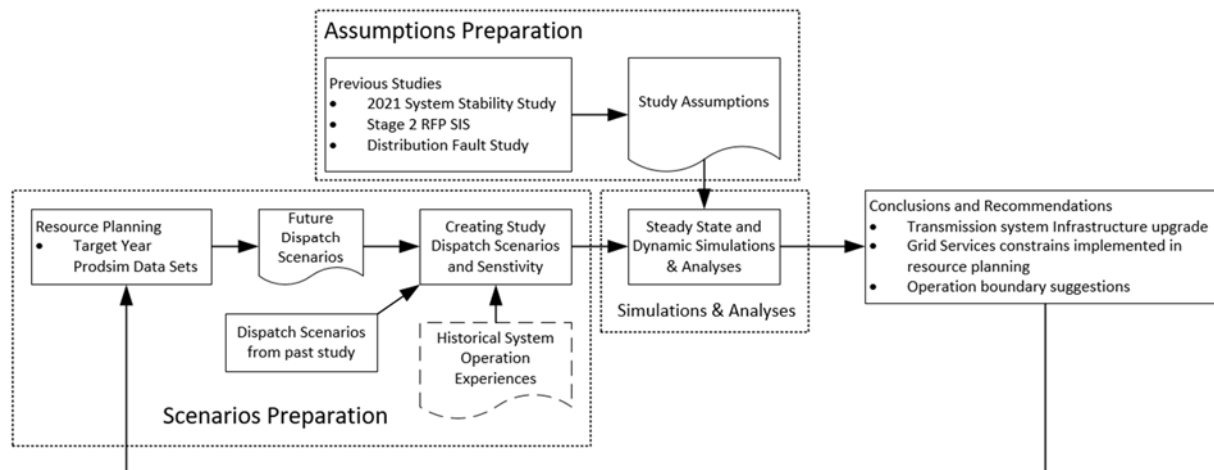
#### 3.3.1 System Security Study

The system security analysis that occurs later in the process, shown in Figure 3-3, will be used to identify the transmission needs to maintain system reliability. This includes steady state and dynamic analysis to inform needs such as, transmission capacity, inertia, short-circuit current, voltage support, and frequency response services.

The preferred procurement scenario described in Section 3.7 will undergo a more extensive system security analysis in PSS/E, PSCAD, and/or Aspen Oneliner based on the outputs of hourly PLEXOS modeling, with the intent to validate the transmission grid needs. The objective of the system security analysis is to understand the grid security and stability under a range of severe yet credible operating conditions of the preferred procurement scenario. High level system security study flowchart is shown in Figure 3-3.



Figure 3-3: High Level Flowchart of System Security Study



The system security study consists of four major steps: 1) scenario preparation, 2) assumption preparation, 3) simulations and analyses, and 4) conclusions and recommendations. In the first step, dispatch scenarios are selected to be analyzed in the system security analysis based on production simulation data generated by the PLEXOS and input from system operation. At minimum, the studied generation dispatch scenarios cover day minimum load, day peak load, night minimum load, and/or evening peak load system conditions. Consistent with the Transmission Planning Criteria, past studies are reviewed in the assumption preparation step, which generates study assumptions for the system security study. In the simulations and analyses steps, system PSS/E and PSCAD models are created which represents both studied scenarios and planning events. From PSS/E simulations and analyses, planning events considered as high risk, and associated generation dispatch scenarios, are identified and are simulated and analyzed in PSCAD. The analysis and identification of needs and mitigations will be performed in accordance with the Hawaiian Electric transmission planning criteria described in Appendix F, and common industry practices, as applicable.

The steady state analysis part of the system security study will identify the needs of transmission capacity and steady state voltage support to ensure that transmission element thermal loading and voltage levels are maintained within the planning criteria (including necessary margin for steady state voltage stability). This is also highly related with the need of system strength which is described about short-circuit current need.

The need for voltage support also will be determined in the dynamic study based on dynamic stability study performed in PSS/E and PSCAD, which evaluates maintaining system voltage stability during and post contingency event to avoid voltage instability and wide range of DER entering into momentary cessation.

Besides voltage stability related needs, frequency stability is also investigated in the system security study. The adequacy of frequency response resource will be evaluated in the study.



The need of frequency response can be filled by adding inertia, primary frequency response or fast frequency response which is determined from the PSS/E and PSCAD dynamic study results. The system security analysis will include a more detailed evaluation of varying system conditions and credible contingencies including loss of the largest generation event. The analysis will produce the following key deliverables:

- Strategies and mitigations required for safe and reliable operation of the grid based on resource portfolio(s)
- Typical and/or boundary dispatch and operational requirements for grid operation based on resource portfolio(s)
- Frequency stability, voltage stability, control stability and rotor angle stability (if applicable) performance of the future grid
- Impacts of transmission events on the distribution system and vice versa
- Evaluation of the need for grid forming technology and demonstration of system performance with this technology when and if needed for the future grid
- Evaluation of weak grid issues and development of a “weak grid” definition for each of the island grids, which includes investments or mitigation strategies to operate a grid with limited to no synchronous generation. Weak grid conditions could include low short circuit current availability, low inertia, and limited reactive power support.
- Identification of additional transmission grid services needed over the near-term 5-year planning horizon
- Roadmap of transmission needs and strategies required to achieve 100 percent renewable energy goals by 2045

#### 3.3.1.1 Grid Forming Inverter Technology

Grid Forming technology is an emerging technology that can assist in achieving system security. It is important to note that currently there is no universally accepted definition of grid forming technology. Grid forming inverters are capable of operating in grid forming mode supporting system operation under normal and emergency conditions without relying on the characteristics of synchronous machines. This includes operation as a current independent AC voltage source during normal and transient conditions (as long as no limits are reached within the inverter), and the ability to synchronize to other voltage sources or operate autonomously if a grid reference is unavailable. These capabilities will vary from manufacturer to manufacturer. However, it is expected that the grid forming inverters will enable safe and reliable grid operation when less synchronous generation is present on the grid. The grid forming inverters will also help with integrating more grid following inverters. While there are some uncertainties related to the impacts of grid forming technology, as the industry evolves and the technology matures, grid forming inverters will play a key role in achieving the 100 percent RPS goal. Thus far, grid forming technology is only commercially available for battery energy storage system (“BESS”) inverters.

The Company recently completed an electromagnetic transient study performed in PSCAD that assessed the impact of Stage 2 solar paired BESS and standalone BESS projects with grid forming inverters. On June 30, 2021, the Company presented the result of this study to the



STWG<sup>24</sup> which represents not only the latest and state of the art of grid forming (GFM) in technology as it applies to the Hawaiian Electric service territories, but also in the industry. The objectives of this study were threefold:

1. To evaluate the potential for reliability concerns in the 2023 timeframe if GFM control technology was not employed in Stage 2 projects;
2. To evaluate the ability of Stage 2 project's GFM controls to improve system performance, and identify potential risks in implementation for this new technology; and
3. To recommend specific changes to Stage 2 projects to help mitigate reliability risks, and identify avenues for future work which will be required to make the Hawaiian Electric island power systems robust as conventional thermal generation is retired or operations reduced.

Common technical issues found in the study included:

- DER Blocking,<sup>25</sup> *i.e.*, momentary cessation, leading to system undervoltage and underfrequency load shed
- Frequency response tuning issues
- Significant voltage response tuning issues
- Instability from GFM when hitting inverter current or energy limits
- Undamped system oscillations
- Certain Stage 1 and 2 grid following ("GFL") inverters not doing frequency response appropriately either in steady state or in extended ride-through modes
- GFL (stage 1 and stage 2) device instability or tripping

There were several general observations:

- In Hawai'i, DER is a dominant factor in dynamic performance, particularly relating to block or trip thresholds. DER blocking en masse results in the most severe conditions on all islands.
- GFM implementation is not as important when the system is intact, provided the controls are configured basically correctly. However, specific implementation (e.g., Manufacturer and control revision) of GFM is critical when faults or major system events cause the GFM devices to reach physical limits.
- GFM may introduce new modes of instability in the system (similar to inter-machine oscillations)

---

<sup>24</sup> Available at, [https://www.hawaiielectric.com/documents/clean\\_energy\\_hawaii/integrated\\_grid\\_planning/igp\\_meetings/20210630\\_electranix\\_report.pdf](https://www.hawaiielectric.com/documents/clean_energy_hawaii/integrated_grid_planning/igp_meetings/20210630_electranix_report.pdf)

<sup>25</sup> Definition of Momentary Cessation is available at NERC reliability guideline BPS-Connected Inverter-Based Resource Performance, September 2018, [https://www.nerc.com/comm/PC\\_Reliability\\_Guidelines\\_DL/Inverter-Based\\_Resource\\_Performance\\_Guideline.pdf](https://www.nerc.com/comm/PC_Reliability_Guidelines_DL/Inverter-Based_Resource_Performance_Guideline.pdf)





- On O`ahu in particular, reliability issues remain for severe dispatches, even with Batteries configured with GFM controls
- Frequency and voltage control sharing is required from all resources (Existing GFL and new GFM)
- Evaluation of protection was not included in this effort, but models are available and ready for use in dedicated protection studies.
- Evaluation of energy availability or operating reserve on BESS is not evaluated here but will determine reliability in future dispatches.
- Synchronous Condensers may be a useful part of the overall solution

Finally, the following is a summary of recommendation from the study:

- The aggressive inverter-based renewable penetration scenarios are beyond what is considered well understood in the industry. These studies are accordingly unusually complex, with many important and in some cases untested assumptions built in. In addition, some of the equipment being proposed is conceptually new and untested (e.g., GFM). There is unavoidable uncertainty both in completing the studies to a schedule and in impact on future power system reliability.
- Continue to require GFM technology, and to implement it for incoming projects for all islands.
- Review requirements document for future RFPs, clarification based on lessons learned.
- Additional validation and tuning of PSCAD DER models is required for future efforts.
- DER should be configured to ride-through, or with block thresholds at the lowest possible levels.
- UFLS should be reviewed. It is not effective if much of the DER is disconnected along with the load (35-55% of DER connected behind UFLS relays in our models).

The Company will build upon this study as part of the system security analysis in the Grid Needs Assessment modeling framework.

### 3.3.2 Renewable Energy Zones (REZ) Study

The second component in assessing Transmission Needs is the development of Renewable Energy Zones (REZ), which includes development of transmission capacity needs to integrate higher levels of renewable energy. As discussed in the August I&A Update, the REZ study leveraged the NREL resource potential study update to identify long term transmission capacity needs to enable potential renewable zones needed to harness renewable energy on each island.<sup>26</sup>

---

<sup>26</sup> See NREL's Assessment of Wind and Photovoltaic Technical Potential for the Hawaiian Electric Company at [https://www.hawaiianelectric.com/documents/clean\\_energy\\_hawaii/integrated\\_grid\\_planning/stakeholder\\_engagement/stakeholder\\_council/20210730\\_sc\\_heco\\_tech\\_potential\\_final\\_report.pdf](https://www.hawaiianelectric.com/documents/clean_energy_hawaii/integrated_grid_planning/stakeholder_engagement/stakeholder_council/20210730_sc_heco_tech_potential_final_report.pdf)





The REZ concept<sup>27</sup> will require an extensive planning process centered around community and stakeholder engagement; however, the intent of the renewable energy zone concept is to identify the cost of potential transmission upgrades that will allow RESOLVE to determine whether generation in various zones on each island and transmission buildout decisions are least-cost compared to non-wires alternatives or alternate sites and resources. If determined to be directionally cost-effective then developing renewable energy zones may be included in the resulting IGP action plan and long-term procurement. Additional information regarding renewable energy zone analysis is provided in the August I&A Update.

An updated REZ study<sup>28</sup> has been completed and will be filed concurrent to this filing under Docket No. 2018-0165. The study has been done in accordance with the Hawaiian Electric transmission planning criteria included in Appendix F and common industry practices, as applicable. The analysis will include the following key components:

- 1) Develop a 2040 base case (end state) utilizing the forecasted demand, DER forecast and planned resources (e.g., stage 1 and 2 RFP projects). The NREL Resource Potential Update Study will provide renewable energy zone (REZ) maps for each island to inform the potential location of future renewable resources.
- 2) Identify the injection capacity available at each transmission substation to prioritize favorable locations for renewable energy injections into the system from a technical and engineering perspective. Land use and community engagement, and other issues, will be incorporated into the overall REZ process if first deemed viable from a technical and economic perspective.
- 3) Based on above insight and location of the potential REZ, identify if transmission trunk lines need to be built to transport renewable energy from the REZ locations to the favorable locations on the transmission grid.
- 4) Identify additional transmission capacity needs in 2040 based on the transmission planning criteria. This would include new transmission facilities as well as upgrades to the existing infrastructure.
- 5) Identify steady-state voltage support required, if any, due to taking conventional generation offline.

Table 3-1: Transmission Input Summary

Input	Units	Description	Data Source
Transmission limits between zones	MW	Depends on how topology is defined – RESOLVE is a zonal model	Transmission Need Analysis

<sup>27</sup> See NREL’s renewable energy zone guidebook, <https://www.nrel.gov/docs/fy17osti/69043.pdf> and the process undertaken at AEMO, <https://aemo.com.au/-/media/files/major-publications/isp/2020/appendix--5.pdf?la=en>

<sup>28</sup> Prior draft provided to IGP stakeholders: [https://www.hawaiianelectric.com/documents/clean\\_energy\\_hawaii/integrated\\_grid\\_planning/stakeholder\\_engagement/working\\_groups/stakeholder\\_technical/20211001\\_renewable\\_energy\\_zones\\_draft.pdf](https://www.hawaiianelectric.com/documents/clean_energy_hawaii/integrated_grid_planning/stakeholder_engagement/working_groups/stakeholder_technical/20211001_renewable_energy_zones_draft.pdf)



Input	Units	Description	Data Source
Nomograms / Simultaneous imports/exports limits	MW	E.g., sum of imports from a zone cannot exceed 5 GW. Results of the Transmission Need analysis would show if such a limit exists within each island system	Transmission Need Analysis
Losses	%	System losses for each year for the assumed transmission topology	PSS/E models
Transmission limits for renewable development	MW	If applicable, specify how much capacity can be integrated within current transmission infrastructure.	Transmission Need Analysis
Renewable transmission upgrade cost	\$/kW-yr	If applicable, specify how much it would cost to upgrade transmission to deliver additional renewables beyond the transmission limit in the row above.	Company Unit Cost

### 3.3.2.1 Implementing REZ Study Results in RESOLVE

The REZ study provides two tranches of costs to interconnect the resource potential zones identified by the NREL resource potential study.

- REZ Enablement: New or upgraded transmission lines and substations required to connect the transmission hub of each REZ group to the nearest transmission substation.
- Transmission Network Expansion: Transmission system upgrades not associated with a particular REZ group, and are required to support the flow of energy within the transmission system and provide generation dispatch flexibility.

The RESOLVE model will only include the costs associated with REZ enablement in its first pass on capacity expansion because the transmission network expansion costs may be less if the entire REZ group is not interconnected. The transmission network expansion costs may then be modified to reflect the amount of variable renewables selected in each REZ group and the models re-run with the transmission network expansion costs included to see if their addition dramatically changes the resource buildout from the first pass. This process is described in Figure 3-4 below.



Figure 3-4: Application of REZ Results in RESOLVE Modeling

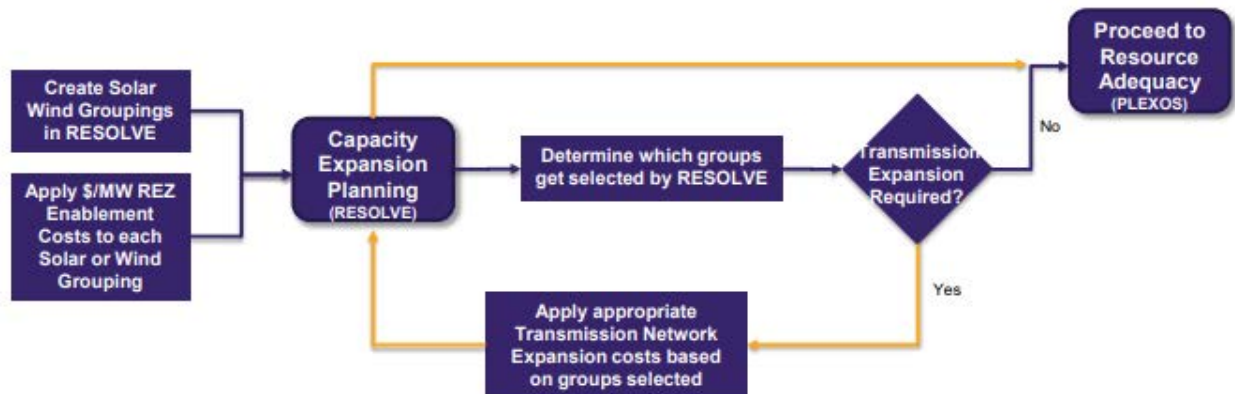


Figure 3-5 through Figure 3-7 below provides the annual revenue requirement adder for REZ enablement that will be incurred as variable renewable capacity within each of the identified REZ groups is interconnected. These costs are considered additive to the capital costs for resource technologies in the August 2021 I&A Update.

Figure 3-5: O’ahu REZ Enablement Costs

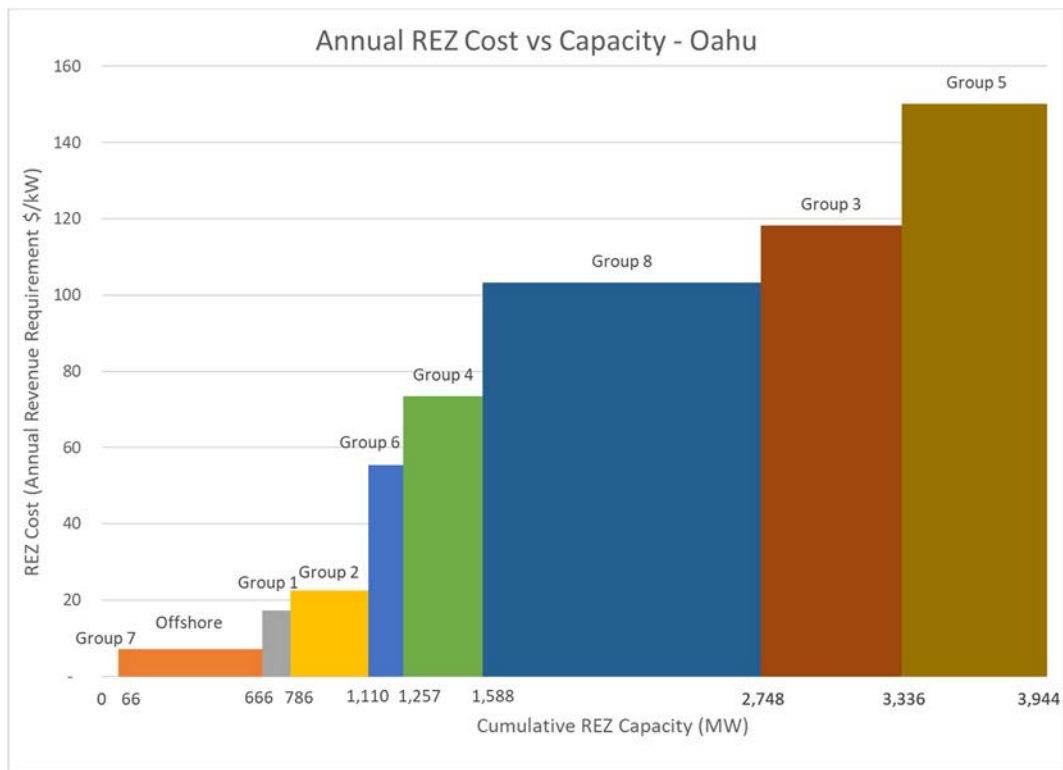


Figure 3-6: Hawai'i Island REZ Enablement Costs

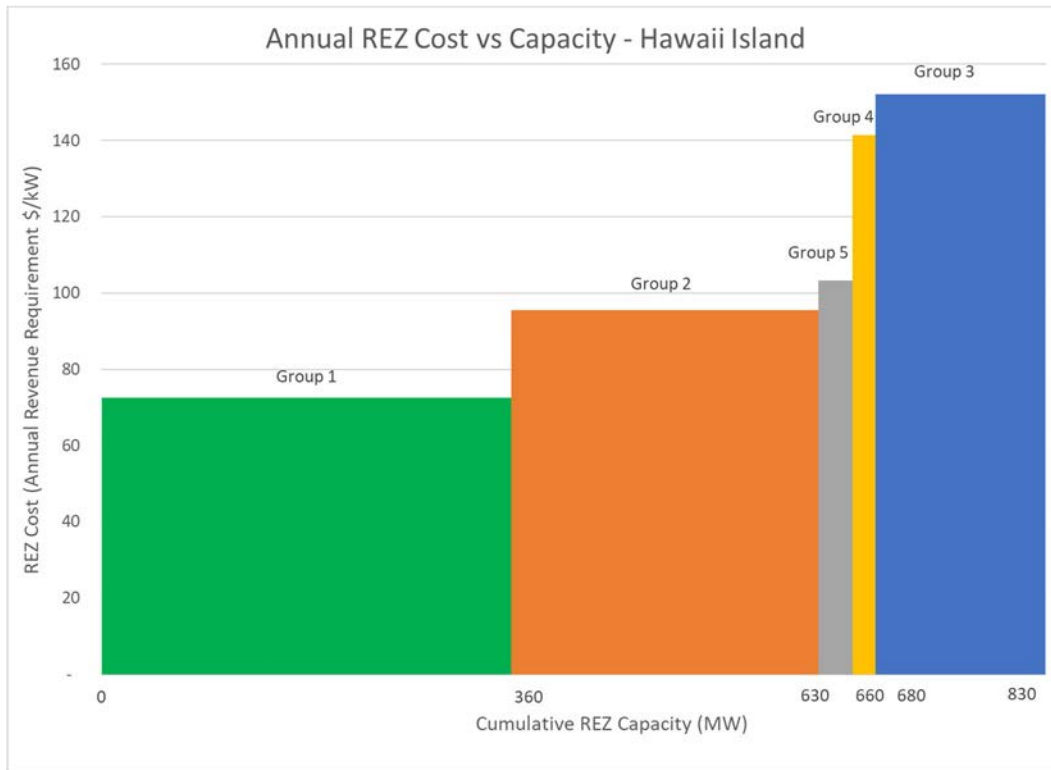
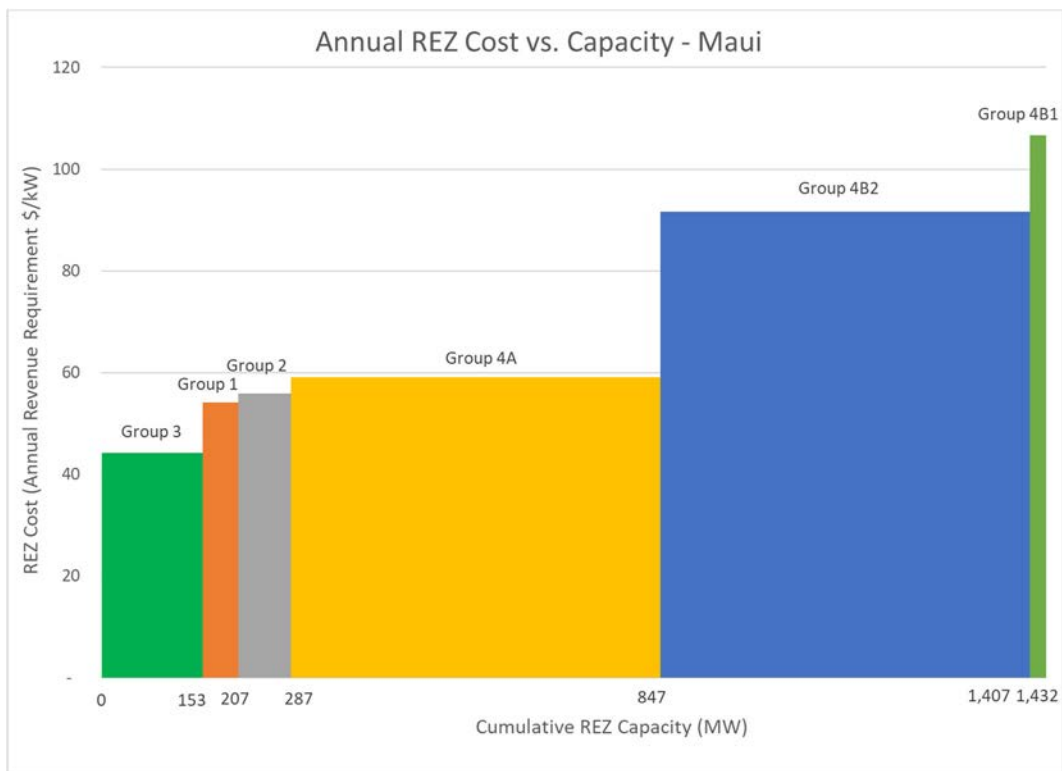


Figure 3-7: Maui REZ Enablement Costs



### 3.3.3 Virtual Inertia and Fast Frequency Response Rules in RESOLVE

Initially, the Company proposed an inertial and fast frequency response constraint in RESOLVE. Resources needed to provide sufficient inertia and fast frequency response would be selected as part of the least cost optimization in the initial capacity expansion modeling step. The intent was to potentially reduce iterations between the system security step and earlier modeling steps in the modeling framework. However as discussed in Section 2.2.3.1, Ulupono disagreed with the inclusion of these rules in the capacity expansion modeling. Ulupono asserted that inertia and fast frequency requirements should be based on stability studies. To determine whether these rules had an adverse impact on the optimization, the Company assessed<sup>29</sup> the impact of the minimum inertia requirement on the resource plans in RESOLVE.

Table 3-2: Inertia Criteria Testing

NPV (2018\$, \$MM)	O'ahu	Hawai'i Island	Maui
<b>Reference (with inertia requirement)</b>	15,772	2,103	2,471
<b>Remove Inertia Requirement</b>	15,646	2,092	2,405
<b>% Difference compared to Base</b>	-0.8%	-0.5%	-2.7%

As shown in Table 3-2, removing the inertia requirement had a negligible difference in cost over the 25-year study horizon (years 2025-2050). The Hawaii Island plan did not have any substantial differences in the resource plan. The O'ahu resource plan built approximately 467 MW additional solar paired with 4-hr PV without the inertia requirement than with the inertia requirement; however, the cost difference between the two plans were only 0.8%. The Maui plan built 13 MW of synchronous condensers over the 25 years in the reference plan, which led to about a 2.7% decrease in costs when the inertia requirement was removed.

Despite the marginal overall cost differences, the Company will remove the inertia and fast frequency response requirement from RESOLVE, and per Ulupono's recommendation determine those needs through the stability studies in the System Security analysis. In their Reply Comments to the August I&A Update on pages 7-8, Ulupono agreed with this path forward.

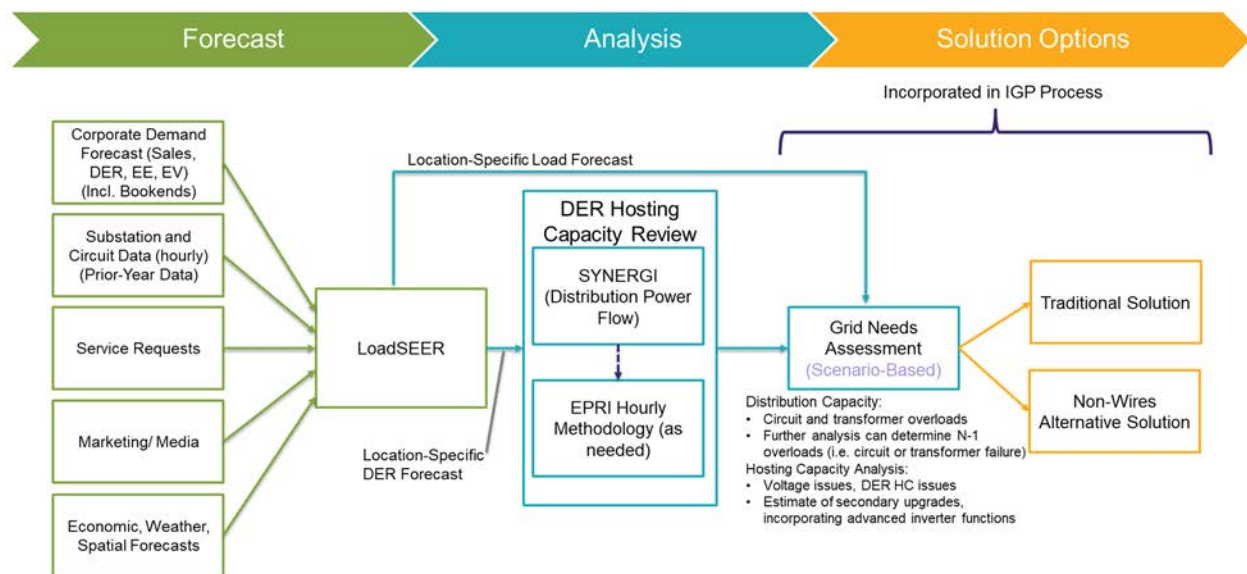
<sup>29</sup> See STWG Meeting on July 14, 2021, available at: [https://www.hawaiianelectric.com/documents/clean\\_energy\\_hawaii/integrated\\_grid\\_planning/igp\\_meetings/20210714\\_presentation\\_slides\\_igp.pdf](https://www.hawaiianelectric.com/documents/clean_energy_hawaii/integrated_grid_planning/igp_meetings/20210714_presentation_slides_igp.pdf)



### 3.4 DISTRIBUTION NEEDS

Distribution needs will be analyzed using LoadSEER and Synergi distribution planning models. The identification of distribution Grid Needs will follow the distribution process illustrated in Figure 3-8.

Figure 3-8: Distribution Planning Process



The distribution Grid Needs will be identified based on two distribution services that were defined through the Distribution Planning Working Group. The distribution Grid Needs are based on distribution planning criteria and are defined as:

- Distribution capacity – A supply and/or a load modifying service that DERs provide as required via reduction or increase of power or load that is capable of reliably and consistently reducing net loading on desired transmission and/ or distribution infrastructure. T&D capacity service can be provided by a single DER and/or an aggregated set of DERs that reduce the net loading on a specific distribution infrastructure location coincident with the identified operational need in response to a control signal from the utility.<sup>30</sup>
- Distribution reliability (back-tie) – A supply and/or load modifying service capable of improving local distribution reliability under abnormal conditions. Specifically, this service reduces contingent loading of grid infrastructure to enable operational

<sup>30</sup> See NWA Opportunity Evaluation Methodology, June 2020 at 12. Available at, [https://www.hawaiianelectric.com/documents/clean\\_energy\\_hawaii/integrated\\_grid\\_planning/stakeholder\\_engagement/working\\_groups/distribution\\_planning/20200602\\_dpwg\\_non\\_wires\\_opportunity\\_evaluation\\_methodology.pdf](https://www.hawaiianelectric.com/documents/clean_energy_hawaii/integrated_grid_planning/stakeholder_engagement/working_groups/distribution_planning/20200602_dpwg_non_wires_opportunity_evaluation_methodology.pdf)



flexibility to safely and reliably reconfigure the distribution system to restore customers.<sup>31</sup>

As part of identifying distribution Grid Needs, the DPWG developed a Non-Wires Opportunity Evaluation Methodology (see Appendix J) to appropriately identify the capital investments that are prime opportunities to be deferred by NWA solutions.

The framework, shown in Figure 3-9, is a three-step methodology that incorporates 1) an initial NWA opportunity screen, 2) an NWA opportunity sourcing evaluation and 3) an action plan. The initial opportunity screen is intended to quickly and simply identify “qualified” and “non-qualified” T&D opportunities based on technical requirements and timing of need. The opportunity sourcing evaluation in the second step further evaluates and prioritizes the “qualified” opportunities in terms of the grid project avoided cost (economics), uncertainty regarding timing and/or scope of need, and market potential to support a procurement. This three-step approach is based on leading practices from states in the Northeast and from California as well as stakeholder feedback tailored to Hawai‘i’s needs.

This methodology is designed to identify a wider set of potential NWA opportunities than methodologies in other states. Step 1 does not include a dollar threshold, unlike the states in the Northeast; instead, program or pricing options may be considered viable in the Step 2 evaluation. The incorporation of program and pricing options in the Step 2 sourcing evaluation is for those opportunities considered too financially small for procurement. Step 2 methodology also includes a clearly defined minimum dollar threshold for procurements identified by stakeholders that is similar in approach to that of the states in the Northeast. This is a more transparent method than the overly complex California approach<sup>32</sup> that also effectively uses the project capital avoided cost as the primary economic threshold. The resulting T&D action plan in Step 3 is intended to enable a range of potential NWA sourcing options via procurement, programs, and pricing consistent with another RMI recommendation.<sup>33</sup>

---

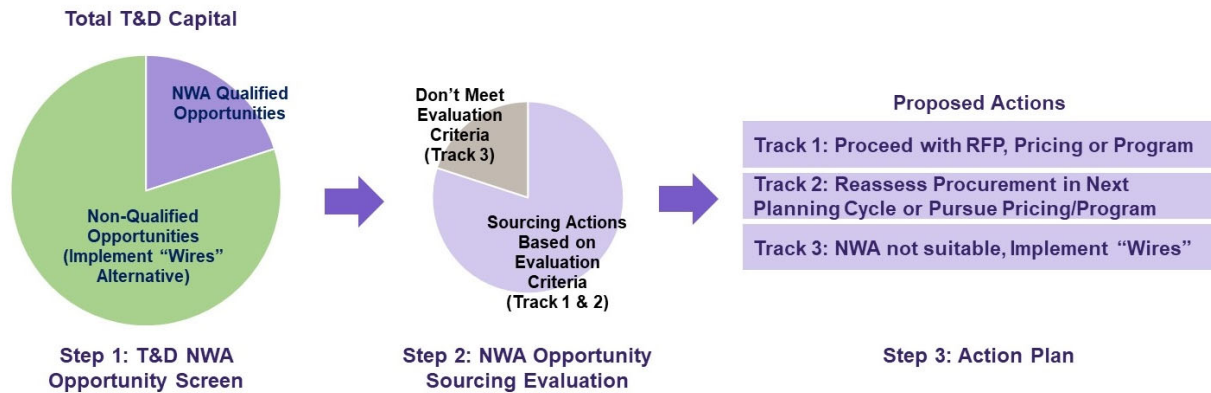
<sup>31</sup> *Id.*

<sup>32</sup> See Pacific Gas & Electric, Request for Approval to Issue Competitive Solicitations for Distributed Energy Resource (DER) Procurement for Electric Distribution Deferral Opportunities. November 15, 2019. CPUC Advice Letter 5688-E. and Southern California Edison, Southern California Edison Company’s Request for Approval to Launch the 2020 Distribution Investment Deferral Framework, November 15, 2019 Solicitation. CPUC Advice Letter 4108-E.

<sup>33</sup> M. Dyson, J. Prince, et al., “The Non-Wires Solutions Implementation Playbook”, Rocky Mountain Institute, 2018, page 39.



Figure 3-9: NWA Opportunity Evaluation Methodology



For more details regarding the distribution planning process and NWA opportunity evaluation framework, refer to the DPWG deliverables,<sup>34</sup> *Distribution Planning Methodology (Appendix I)*, and *NWA Opportunity Evaluation (Appendix J)*, the June 17, 2021 STWG meeting,<sup>35</sup> and the August 2021 *Distribution DER Hosting Capacity Grid Needs Report*.<sup>36</sup> The TAP’s review of these deliverables can be found in Appendix K, including recommendations that the Company has incorporated.

### 3.5 GRID NEEDS

Inclusive of the inputs and analyses described above, the following Grid Services have been identified as defining the Grid Needs. The definitions provided in Table 3-3: describe which models will either partially or fully evaluate the specific service. Generally, RESOLVE and PLEXOS will evaluate services as part of the resource needs step whereas PSS/E, PSCAD, and ASPEN will evaluate services as part of either the transmission or distribution needs steps. The types of properties needed to characterize each service are shown in Table 3-4:, Table 3-5:, and Table 3-6:.

<sup>34</sup> See <https://www.hawaiielectric.com/clean-energy-hawaii/integrated-grid-planning/stakeholder-engagement/working-groups/distribution-planning-and-grid-services-documents>

<sup>35</sup> See [https://www.hawaiielectric.com/documents/clean\\_energy\\_hawaii/integrated\\_grid\\_planning/20210617\\_presentation\\_slides\\_igp\\_stakeholder.pdf](https://www.hawaiielectric.com/documents/clean_energy_hawaii/integrated_grid_planning/20210617_presentation_slides_igp_stakeholder.pdf)

<sup>36</sup> See [https://www.hawaiielectric.com/documents/clean\\_energy\\_hawaii/integrated\\_grid\\_planning/distribution\\_der\\_hosting\\_capacity\\_grid\\_needs\\_03Aug2021.pdf](https://www.hawaiielectric.com/documents/clean_energy_hawaii/integrated_grid_planning/distribution_der_hosting_capacity_grid_needs_03Aug2021.pdf)





Table 3–3: Grid Service Definitions

Grid Service	Definition	Represented in RESOLVE & PLEXOS	Represented in PSSE/PSCAD/ASPEN
<b>Energy</b>	A continuous, controllable, and predictable supply of megawatt-hours to serve system load needs in response to Company Dispatch <sup>37</sup>	✓	Not Represented
<b>Energy Reserve Margin</b>	A guideline to minimize risk of insufficient generation capability from a diverse mix of generating resources available to the system in long-range generation expansion studies	✓	Not Represented
<b>Load Reduce</b>	Capacity that can be provided by a generator, storage, or controlled load to reduce system load in the required timeframes and durations in response to a remote dispatch signal.	✓	Not Represented
<b>Load Build</b>	Capacity that can be provided by storage or controlled load to increase system load in the required timeframes and durations in response to a remote dispatch signal.	✓	Not Represented
<b>Regulating Reserves</b>	A reserve capacity provided by generating and load resources to allow continuous energy balance over the next 1 minute and 20 to 30 minute time interval due to the variability in renewable resources and load that can be called upon in response to Company Dispatch. The quantitative analysis for Regulating Reserves is described in Appendix D.	✓	Not Represented
<b>Inertia</b>	Contribution to the capability of the power system to resist changes in frequency by means of an inertial response from a generating unit, network element or other equipment that is electromagnetically coupled with the power system and synchronized to the frequency of the power system.	Requirements removed from RESOLVE based on stakeholder feedback. System Security Analysis to evaluate Inertia requirements	✓

<sup>37</sup> "Company Dispatch" as defined in the PPA and SFC means Company's right, through supervisory equipment or otherwise, to direct or control both the capacity and the energy output of the Facility from its minimum output rating to its maximum output rating consistent with this Agreement (including, without limitation, Good Engineering and Operating Practices and the requirements set forth in Section 3 (Performance Standards) of Attachment B (Facility Owned by Subscriber Organization to this Agreement), which dispatch shall include real power, reactive power, voltage, frequency, the determination to cycle a unit off-line or to restart a unit, the droop control setting, the ramp rate setting, and other characteristics of such electric energy output whose parameters are normally controlled or accounted for in a utility dispatching system.







Grid Service	Definition	Represented in RESOLVE & PLEXOS	Represented in PSSE/PSCAD/ASPEN
<b>Primary Frequency Response (PFR)</b>	Automatic and autonomous response to frequency variations through a generator’s droop parameter and governor response.		✓
<b>Fast Frequency Response (FFR1)</b>	An autonomous and predictable capacity to limit the frequency drop resulting from a frequency disturbance.	Requirements removed from RESOLVE based on stakeholder feedback. System Security Analysis to evaluate Inertia requirements	✓
<b>Voltage Support</b>	Ability of generators or other equipment to produce or absorb reactive power to maintain the system voltages within specified limits.	Not Represented	✓
<b>Short-Circuit Current</b>	Available current under fault conditions at a given location. A minimum value is required for proper coordination of protective devices and a safe and reliable operation of protection system.	Not Represented	✓
<b>RPS</b>	% of annual retail sales forecast	✓	Not Represented
<b>Transmission Capacity</b>	A supply and/or a load modifying service that DERs and grid-scale resources provide as required via the dispatch of power output for generators and electric storage, and/or reduction in load that is capable of reliably and consistently reducing net loading on desired transmission infrastructure in response to Company Dispatch.		✓
<b>Distribution Capacity</b>	A supply and/or a load modifying service that DERs provide as required via the dispatch of power output for generators and electric storage, and/or reduction in load that is capable of reliably and consistently reducing net loading on desired distribution infrastructure in response to Company Dispatch.		Represented in Synergi/LoadSEER
<b>Distribution Reliability</b>	A load modifying or supply service capable of improving local distribution reliability under abnormal conditions (i.e., substation N-1) in response to Company Dispatch.		Represented in Synergi/LoadSEER



Table 3-4: Grid Service Properties for Modeling (1 of 3)

Property	Energy Service	Energy Reserve Margin Service	Load Reduce Service	Load Build Service	Regulating Reserve Service
Resource Type	Firm Generator Variable Generators Storage	Firm Generator Variable Generators Storage	Firm Generator Variable Generator Storage Load Under Control	Storage Load Under Control	Firm Generator Variable Generator Storage Load Under Control
Availability	Months	Months	Months	Months	Need by Hour
Size	MW	MW	MW	MW	MW
Duration	Hours	Hours	Hours	Hours	
Delivery Timeframe	Hours	Hours	Hours	Hours	
Probability of Exceedance	%	%			
Number of Service Calls			As specified	As specified	
Regulating Reserve Type					1 – minute or 20-30 minute
Ramping Capability					MW/ minute
Service Source	Market Service	Market Service	Market Service	Market Service	Market Service

Table 3-5: Grid Service Properties for Modeling (2 of 3)

Property	Fast Frequency Response (FFR-1) Service	Primary Frequency Response (PFR)	Short Circuit Current	Inertia	Voltage Support
Resource Type	Variable Generator Storage Load Under Control	Firm Generator Variable Generator Storage Load Under Control	Synchronous generators Synchronous Condensers	Synchronous generators Synchronous Condensers	Firm/Variable Generator Storage Synchronous Condenser Reactive Devices (SVC, Statcom, Capacitors, etc.)
Availability	12 cycles or less	Seconds	Cycles	Instantaneous	Cycles



<b>Size</b>	MW	MW	Amperes	Joules	MVAR
<b>Duration</b>	Minutes	Seconds	Cycles		
<b>Number of Service Calls</b>	As specified				
<b>Reaction Time</b>	As specified	As specified	Instantaneous	Instantaneous	As Specified
<b>Rise Time</b>	Milliseconds	Milliseconds			
<b>Setting Time</b>	Milliseconds	Milliseconds			
<b>Overshoot</b>	%	%			
<b>Setting Band</b>	%	%			
<b>Service Source</b>	Market Service	Mandatory Requirement in 14H and PPAs	Non-Market Service	Non-Market Service	Non-Market Service

Table 3-6: Grid Service Properties for Modeling (3 of 3)

<b>Property</b>	<b>Distribution Capacity Service</b>	<b>Distribution Reliability (Back-Tie) Service</b>
<b>Resource Type</b>	Firm Generator Variable Generator Storage Load Under Control	Firm Generator Variable Generator Storage Load Under Control
<b>Availability</b>	Seconds	Seconds
<b>Size</b>	MW	MW
<b>Duration</b>	Hours	Hours
<b>Number of Service Calls</b>	Delivery Months, Delivery Hours, and Max Days per year	Delivery Months, Delivery Hours, and Max Days per year
<b>Service Source</b>	Market Service	Market Service

In addition to the tables above, the Grid Needs can be shown graphically to illustrate the seasonal and time of day need for certain services. As an illustrative example, Grid Needs for the load reduce service are shown in the figures below.



Figure 3-10: Example of Monthly Calls for Load Reduce in Year 2025

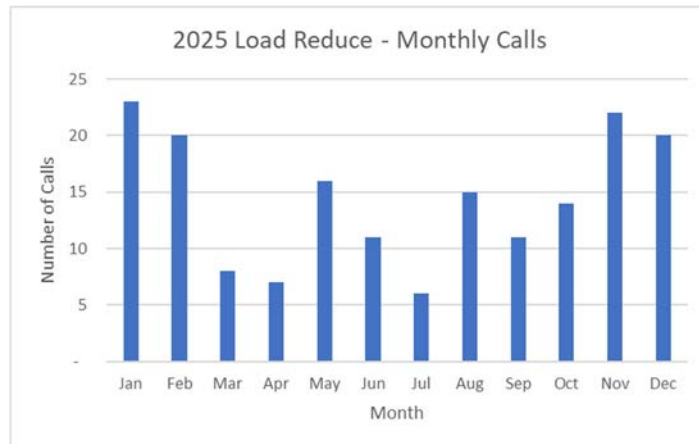


Figure 3-11: Example of Monthly Calls for Load Reduce Across the Planning Horizon

Year	Jan	Feb	Mar	Apr	May	Jun	Jul	Aug	Sep	Oct	Nov	Dec	
2025	23	20	8	7	16	11	6	15	11	14	22		
2030	26	22	14	9	15	15	5	23	12	15	21	22	
2040	22	22	11	6	12	14	5	18	9	15	22	22	
2045	18	20	7	4	8	9	1	12	11	17	19		
2050	3	4						2	4	2	3	2	1

Figure 3-12: Example of Hourly Calls for Load Reduce in 2025

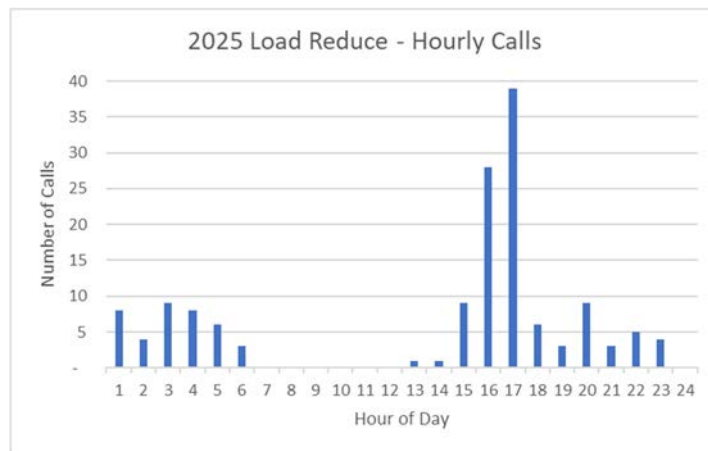


Figure 3-13: Example of Hourly Calls for Load Reduce Across the Planning Horizon

Year	1	2	3	4	5	6	7	8	9	10	11	12	13	14	15	16	17	18	19	20	21	22	23	24
2025	8	4	9	8	6	3	-	-	-	-	-	-	1	1	9	28	39	6	3	9	3	5	4	-
2030	5	2	9	13	7	3	1	-	-	-	-	-	-	-	15	30	32	15	10	6	4	6	3	-
2040	6	8	3	9	8	1	-	-	-	-	-	-	-	-	3	26	35	13	3	6	7	8	5	-
2045	7	5	5	4	10	2	1	-	-	-	-	-	-	-	3	8	19	8	6	9	4	7	2	-
2050	-	3	3	-	3	2	-	-	-	-	-	-	-	-	-	-	3	1	-	1	2	-	-	-

### 3.5.1 Grid Service Capability by Technology

Based on feedback from both the TAP at the December 17, 2020 meeting<sup>38</sup> and stakeholders, Table 3-7 provides technologies that are available today and can provide the various grid services. The grid services modeled by the various modeling tools are eligible to be provided by the appropriate resource technology as indicated in the table.


However, solution sourcing is intended to be agnostic of technology; therefore, Table 3-7 is not meant to constrain potential solution proposals. Further, not all candidate resources may be modeled as an option for selection in RESOLVE. The least-cost representative technology from each of these resource categories will be input into RESOLVE to allow the portfolio selection to solve in a timely manner. For example, a conventional thermal resource could be represented by a biofuel capable combined cycle and not require modeling of all conventional thermal resources as resource options. The representative technology is only meant to serve as a proxy for a resource capable of providing the suite of grid services in Table 3-7 and does not assume any requirements for a particular resource in the RFPs that are evaluated in the solution evaluation phase of the IGP process.


<sup>38</sup> Meeting notes available at, [https://www.hawaiianelectric.com/documents/clean\\_energy\\_hawaii/integrated\\_grid\\_planning/stakeholder\\_engagement/technical\\_advisory\\_panel/20201217\\_tap\\_meeting\\_summary\\_notes.pdf](https://www.hawaiianelectric.com/documents/clean_energy_hawaii/integrated_grid_planning/stakeholder_engagement/technical_advisory_panel/20201217_tap_meeting_summary_notes.pdf)




Table 3-7: Grid Service Capability by Technology

Service by Resource	Inertia	Fast freq. response	Primary freq. response	Reg Reserve	Energy Reserve Margin	Tx Capacity	Dist Capacity	Energy	Load Reduce	Load Build	Short-circuit current	Volt. Support	RPS	Grid Forming <sup>5</sup>
Conventional Thermal	Green	Red	Green	Green	Green	Green	Green	Green	Green	Red	Green	Green	Yellow	Green
PSH	Green	Red	Green	Green	3	Green	Green	Green	Green	Green	Green	Green	Red	Green
GS BESS	Yellow	Green	Green	Green	3	Green	Green	Green	Green	Green	1	Green	Red	Green
Paired Wind	Yellow	Green	Green	Green	2	Green	Green	Green	Green	Red	1	Green	Green	Red
Paired GS PV	Yellow	Green	Green	Green	2	Green	Green	Green	Green	Red	1	Green	Green	Red
Standalone Wind	Yellow	Green	Green	Green	2	*	*	Green	Green	Red	1	Green	Green	Red
Standalone GS PV	Yellow	Green	Green	Green	2	*	*	Green	Green	Red	1	Green	Green	Red
Dist. BESS	Yellow	Green	Green	4	3	Green	Green	Green	Green	Green	1	Green	Red	Red
Dist. PV	Yellow	Green	Green	4	2	*	*	Green	Green	*	1	Green	Green	Red
Load Control	Red	Green	Green	4	Yellow	Green	Green	Yellow	Green	Green	Red	Red	Red	Red
Energy Efficiency	Red	Red	Red	Red	Yellow	Green	Green	Red	Green	Red	Red	Red	Red	Red
Sync. Cond.	Green	Red	Red	Red	Red	Red	Red	Red	Red	Red	Green	Green	Red	Green

 Resource is generally capable of providing the service

 Resource is partially capable of providing the service or limited due to certain constraints. See numbered notes below for additional clarification.

 Resource is not capable of providing the service

1. Requires grid forming inverter capability; 3-5+ years away (Technology in transition)
2. Contribution to ERM limited by hourly dependable capacity
3. Contribution to ERM subject to change as resource portfolio changes
4. Requires controllability/communications for frequent dispatch signals (i.e., AGC)
5. Area of research; however, in general there's an emerging consensus that a resource is needed to provide very short-term voltage stability (i.e., form the voltage waveform) in high inverter-based systems.

\* Partially capable following stakeholder feedback

In the RESOLVE model, all of the technologies noted in Table 3-7 are being modeled. However, all of the technologies except for load control and synchronous condensers are candidate options that can be selected. Load control can be proxied by other available resources selected in the RESOLVE modeling and is further described in Appendix E as part of the Load Build and Load Reduce services. Synchronous condensers do not need to be considered as a selectable



resource based on initial modeling analyses on the inertia requirement described in Section 3.3.3 which resulted in the inertia requirement being removed from RESOLVE.

### 3.6 SCENARIO DESIGN FOR GRID SERVICE NEEDS IDENTIFICATION

Hawaiian Electric proposes using scenario analysis as the principal framework for identifying Grid Needs for each island’s grid. The inputs and grid service definitions described below will be used to develop scenarios and sensitivities to capture a reasonable range of potential outcomes relevant for the Company’s planning.

Hawaiian Electric and stakeholders have developed a base scenario that represents the most plausible or realistic forecast. The Company has also solicited feedback from stakeholders to identify additional sensitivities (similar to the work done in the December 2016 Power Supply Improvement Plan update) to understand the effects of certain assumption changes.

Detailed information on each of the sensitivities that will be evaluated in IGP are provided in the August I&A Update. A summary of the sensitivities are provided in Table 3-8, below.

Table 3–8: Summary of IGP Modeling Sensitivities

Sensitivity Name	Purpose
1. <b>High Load Customer Technology Adoption Bookend</b>	Understand the impact of customer adoption of technologies for DER, electric vehicles, energy efficiency, and time-of-use rates that lead to higher loads.
2. <b>Low Load Customer Technology Adoption Bookend</b>	Understand the impact of customer adoption of technologies for DER, electric vehicles, energy efficiency, and time-of-use rates that leads to lower loads.
3. <b>DER Freeze</b>	Understand the value of the distributed PV and BESS uptake in the Base forecast. Informative for program design and solution sourcing.
4. <b>EV Freeze</b>	Understand the value of the electric vehicles uptake in the Base forecast. Informative for program design and solution sourcing.
5. <b>EE Freeze</b>	Understand the value of the energy efficiency uptake in the Base forecast. Informative for program design and solution sourcing.
6. <b>Land Constrained</b>	Understand the impact of limited availability of land for future solar, onshore wind, and biomass development.





Sensitivity Name	Purpose
7. No State ITC for PV	Understand the impact of removing the state ITC for PV.
8. Low Renewable Generation	Understand the value of the resource portfolio during periods of low renewable production and additional forced outage combinations.
9. High Fuel Price	Understand the impact of higher fuel prices on the resource plan.

### 3.7 GRID NEEDS ASSESSMENT MODELING PROCESS

The overall IGP process is expected to be run on a two-year cycle as shown in Figure 1-1. Within this process, the Company expects large resource and grid service procurements to occur once per cycle, while utility programs and Transmission and Distribution (“T&D”) NAWs will be evaluated on an annual basis to address rapidly evolving local needs.

Based on guidance provided by the Commission, Hawaiian Electric will expand the role of the TAP to provide independent evaluation of the Grid Service Needs Identification. In this phase of the IGP process, the TAP may independently review and verify the methodology and results developed by the Company.

The resource portfolio selected at the end of each IGP cycle will form the basis for the assumptions in the next cycle. At the start of each cycle, as shown in Figure 1-1, existing resource plans and input assumptions will be re-evaluated and refreshed based on the best-available information on each island. Additionally, the Company will solicit stakeholder, Commission, and Consumer Advocate (“CA”) review on these input assumptions.

#### 3.7.1 Initial Scenario Analysis

In the first phase of Grid Needs Assessment, Hawaiian Electric will run RESOLVE in annual and 5-year increments through the modeling horizon (2027-2034, 2040, 2045, 2050) to develop long-term resource portfolio plans (“reference portfolios”) based on a base set of assumptions as well as the scenarios and sensitivities described in Table 3-8. As described in Section 3.1, the Company will seek stakeholder and TAP feedback on these initial RESOLVE portfolios, and make any modifications or conduct iterations as necessary.

The objective in this first phase is to use the results of the various RESOLVE cases (and any necessary iterations) to create a Preferred Grid Needs Portfolio. This likely will result in changes to the base case based on certain assumptions or outputs of sensitivities designed to



test base assumptions. In other words, the Preferred Grid Needs Portfolio could end up comprising of a combination of inputs and assumptions from various sensitivities. Not all RESOLVE sensitivities were intended to carry forward to the PLEXOS steps to evaluate reliability and production costs.

Other than cost, the Company along with stakeholders will consider the objectives described in Section 1. For example, RPS achievement, carbon reduction, reliability, community impacts and land use, and resilience. Quantifiable factors such as RPS, carbon reduction, and reliability can be quantitatively compared to other plans or sensitivities. Community impacts, land use, and resilience may require qualitative assessments by the Company and stakeholders.

For the freeze cases, since they are intended to inform program design, there is less of a need to examine their impact to system security as their intent is to inform the value of the forecast layer and operating characteristics.

### 3.7.2 Preferred Grid Needs Portfolio

The Preferred Grid Needs Portfolio will be developed based on the outcome of the Initial Scenario Analysis vetting with stakeholders. While it is preferable to advance a single agreed upon scenario for further consideration, the Company recommends that if more than one Grid Needs Portfolio is to be carried forward to PLEXOS analysis that no more than 2-3 scenarios advance in the modeling framework process to be further vetted for Resource Adequacy and Production Cost Simulations.

The System Security analysis should be constructed to evaluate certain situations or dispatches based on the production simulations that are distinct or unique. Although there may be 2 or 3 scenarios being evaluated in PLEXOS it's likely dispatches across the scenarios are similar in terms of the capability and technologies in certain years. Therefore, the Company will identify unique dispatches across the scenarios to determine System Security cases to analyze for identification of needs for the portfolios under consideration.

Throughout this process, the Company will continue to engage stakeholders to seek feedback and provide transparency in decision making.

During the discussions of a Preferred Grid Needs Portfolio(s) the Company will also discuss appropriate solution sourcing mechanisms. The Company will strive to reach consensus or provide recommendations based on stakeholder feedback on the method in which Grid Needs will be sourced (*i.e.*, programs, pricing, procurements). This discussion will also include certain scenarios that will require additional investment such as enablement of renewable energy zones, synchronous condensers, or other enabling technologies and investments.

The comparison of the various resource portfolios and the determination of Hawaiian Electric's Preferred Procurement Scenario will be shared with stakeholders at the Second Review Point shown on Figure 1-1.



### 3.7.3 Final Grid Needs Portfolio

Based on stakeholder and Commission feedback during the Second Review Point, a Final Grid Needs Portfolio will be established for use in defining the Grid Needs and NWA RFPs. The Second Review Point may also include recommendations for new or updated programs or pricing.

### 3.7.4 Solution Sourcing

The Company recognizes through the embedded customer technology layers, that opportunities energy efficiency and other DER can provide, can identify, with stakeholder input, the potential for performance-based energy efficiency and DER programs along with TOU pricing tailored to meet grid needs. The focus here is to identify ways to create these programs that will achieve the significant level of customer technologies that are embedded in the forecast layers, inherently providing services to the system by reducing the net system needs. The 'Freeze Cases' can be leveraged to inform potential value of achieving the forecasted adoption of a particular technology; similar to the work completed in the DER docket proceeding that led to the creation of the Battery Bonus program.

Because programs and pricing will address some of the Grid Needs, competitive procurements to source the remainder of needs will occur after the integrated grid needs step. The procurement sourcing process is described in the Competitive Bidding Framework ("CBF") filing currently under consideration by the Commission in the instant docket.

To closely coordinate the interrelationship of the needs analysis with performance based energy efficiency DER programs resulting from the DER docket, the Company may propose to make updates to DER programs based on the latest market data and information or to address emerging grid needs identified in the IGP process. This could also include updates to pricing, assessment of current market uptake/adoption, and new programs to target locational needs, among others. This approach will allow rapid deployment of program updates.

The Company anticipates that integrating development of performance based DER programs and TOU pricing during the grid needs analysis can achieve the desired value from DER. The modeling will use the energy efficiency programs developed in collaboration with Hawai'i Energy, the DER programs and TOU pricing approach determined in the DER docket, and results of the CBRE procurement. This approach has not been undertaken in the industry before and will likely involve a learning curve to achieve acceptable results. In this regard, the Company's intent is to achieve a good first result that can be improved upon over time.

After first determining how these various DER can meet the identified grid needs, competitive procurements will then be issued to procure resources and grid services to meet the remaining grid needs to satisfy, among other things, customer electricity demand and energy use. Developers and service providers will submit proposals with different types of resources and technologies to contribute towards meeting the cumulative grid needs. Proposals will be evaluated in line with the CBF to satisfy the Grid Needs in a resource portfolio that provides



grid services to meet near to medium term Grid Needs while incrementally progressing towards the decarbonization and RPS goals.

## 3.8 ADDITIONAL OUTPUTS FROM GRID SERVICE NEEDS IDENTIFICATION MODELING

### 3.8.1 Avoided Cost of Service

As described in Section 3.5, Grid Services are defined in RESOLVE and PLEXOS as mathematical constraints.<sup>39</sup> Given that the Final Grid Needs Portfolio represents Hawaiian Electric's best estimate at a least cost portfolio that meets all these Grid Services, this portfolio will set a baseline for the expected quantity, timing, and marginal avoided cost for each of the Grid Services. See Table 3-9 for more details.

Table 3-9: Quantity Units, Time Granularity, and Avoided Cost Units for Grid Services

Grid Service	Quantity Units	Time Granularity	Avoided Cost Units
Energy	MWh	Hourly	\$/MWh
Energy Reserve Margin (ERM)	MW-hour	Hourly	\$/MW-year
Load Reduce	MW-hour	Hourly	\$/MW-hour
Load Build	MW-hour	Hourly	\$/MW-hour
Regulating Reserves	MW-hour	Hourly	\$/MW-hour
RPS	MWh	Annual	\$/MWh
Transmission Deferral	MW-year	Annual	\$/MW-year
Distribution Capacity	MW-year	Annual	\$/MW-year
Distribution Reliability	MW-year	Annual	\$/MW-year

These Grid Needs Assessment modeling outputs will define the procurement targets that Hawaiian Electric will use when developing the RFPs and programs. Due to the interdependent and dynamic nature of many of the Grid Service definitions (as described below), the exact quantity procured at the end of the Solution Evaluation process may differ from those initially set out in the procurement targets; however, Hawaiian Electric will provide stakeholders with a clear understanding of the formulas used to determine the Grid Needs.

The following subsections describe how the quantity, timing, and avoided cost of services are derived from the modeling outputs.

<sup>39</sup> Transmission deferral, distribution capacity, and distribution reliability will be modeled externally and their avoided costs based on the cost of transmission and distribution infrastructure that can be avoided through non-wire alternatives.



### 3.8.1.1 Quantity and Timing

The input parameters to these modeling constraints will determine the quantity of each Grid Need to support the grid. Forecasted load and load shape determines the amount of capacity and energy that needs to be generated on an hourly basis to meet that load. For some Grid Services, such as Regulating Reserve, the requirement will be modeled on an hourly basis and is dependent on the installed capacity of variable energy resources. RESOLVE takes these interdependent requirements into consideration when calculating the least-cost resource portfolio.

The timing of Grid Needs is captured in RESOLVE and PLEXOS through these modeling constraints. As existing resources that provide certain services retire or as the requirement varies due to changing system and portfolio conditions, new resources will be selected to meet each of the modeled Grid Need requirements, indicating the year and time of year that new resources are needed to provide the service.

Resources selected by RESOLVE provide proxies for the amount of grid services that are required in a specific year, month, day, and hour. These can be summarized in tabular form and graphically. Examples are provided in Section 3.5.

### 3.8.1.2 Avoided Cost

Hawaiian Electric proposes to use the marginal cost of each Grid Service as the avoided cost of each Grid Service. These marginal costs are derived from the shadow price on the relevant constraints in the RESOLVE and PLEXOS models. Shadow prices are a fundamental output of constrained optimization problems like those used in RESOLVE and PLEXOS and represent the marginal cost to the overall system of procuring and dispatching resources to provide the next incremental unit of the service. Shadow prices are useful to define prices for hard to value services where a market based price does not exist.

This marginal cost approach is analogous to a market clearing price for procuring an equivalent service in a market context.

The EIA Handbook of Energy Modeling Methods includes an introduction to optimization modeling in Appendix B6 on Mathematical Programming<sup>40</sup>. As explained in the handbook,

An optimization model seeks to optimize (minimize or maximize) an *objective function* subject to *constraints*.

The EIA handbook goes on to explain that several different outputs are intrinsic to the optimal solution:

An optimal solution is characterized by:

- Objective function value

---

<sup>40</sup> Energy Information Administration, "Handbook of Energy Modeling Methods. Appendix B6: Mathematical Programming" (2020), available at <https://www.eia.gov/analysis/handbook/> (accessed March 26, 2021).



- Decision variable values
- Shadow prices (for constraints)
- Slacks (for constraints)
- Reduced costs (for decision variables)

The EIA handbook defines the shadow price as follows:

The *shadow price*, or dual price, of a constraint is the partial derivative of the objective function with respect to the right-hand side of the constraint, evaluated at the point specified by the optimal solution. In other words, a constraint's shadow price tells how much the value of the objective function would change if the scalar portion of the constraint were changed by a small amount.

For some carefully constructed [optimization problems], the shadow price can be interpreted as the price of a resource or product.

As noted in the textbook "Applied Mathematical Programming,"<sup>41</sup>

The shadow price associated with a given constraint corresponds to the change in the objective function when [the constraint] is increased by one unit. Shadow prices usually can be interpreted as marginal costs (if we are minimizing) or marginal profits (if we are maximizing).

To summarize: the solution to an optimization problem includes the marginal costs (*i.e.*, *shadow prices*) of every constraint as an intrinsic part of the solution.

In the RESOLVE model, the *objective function* is the net present value (NPV) of the total resource cost. There are numerous constraints in the model including the service requirements for Grid Needs, RPS, resource potential, etc. In the optimal solution, every constraint will have an associated *shadow price*.

In fact, each Grid Need at every timepoint reflects an individual constraint. For example, a single constraint in the Oahu model is that hour 1 on day 1 in year 2025 must have 75 MW of Downward Regulating Reserves. The *shadow price* on this constraint reflects the change in total system cost that would occur from increasing the reserve need incrementally in that hour. In other words, the *shadow price* on this constraint reflects the marginal cost of Downward Regulating Reserve in that hour.

These marginal costs (*i.e.*, *shadow prices*) are an intrinsic part of the optimal solution alongside the *objective function value* (NPV total system cost) and the *decision variable values* (resource build in each year and operations in each hour).

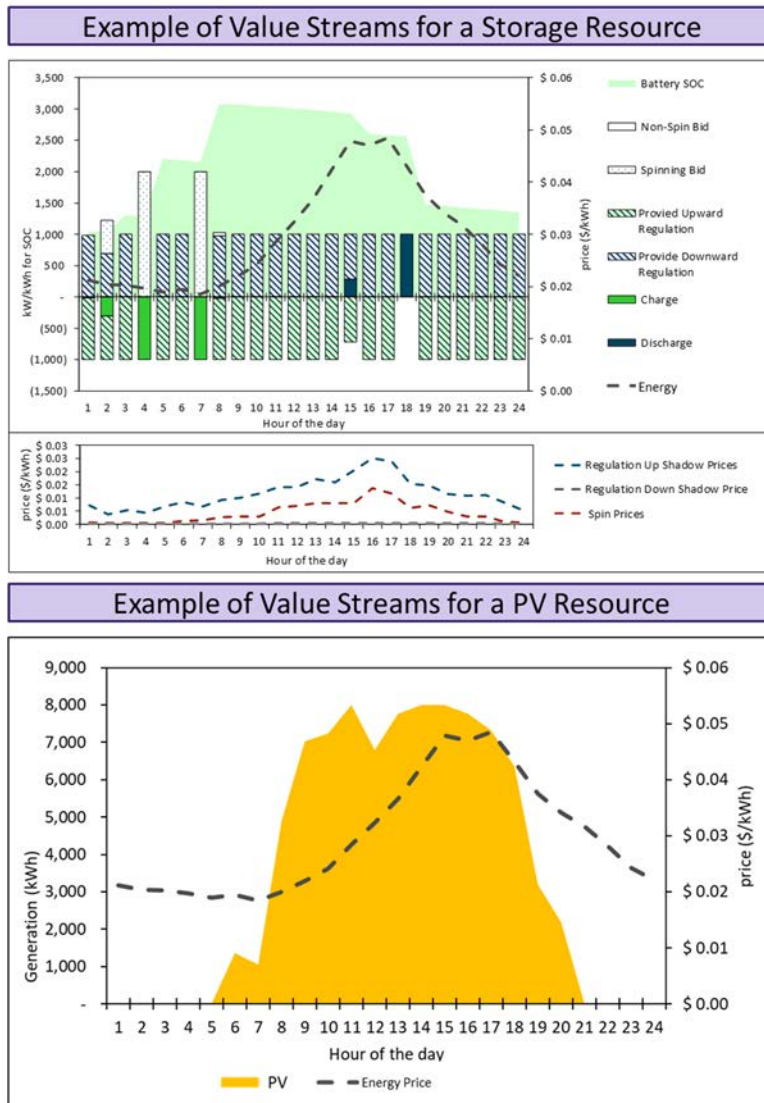
---

<sup>41</sup> Bradley, Hax, and Magnanti, "Applied Mathematical Programming" (1977). Addison-Wesley. Available at <http://web.mit.edu/15.053/www/AMP.htm>.



Figure 3-14 shows how the avoided cost of energy (dashed grey line) can be matched against expected resource production profiles (in this case, storage on the left and solar on the right) to estimate the incremental value of various resource options.

Figure 3-14: Example of Shadow Prices Reflecting the Value & Least-Cost Provision of Various Grid Services



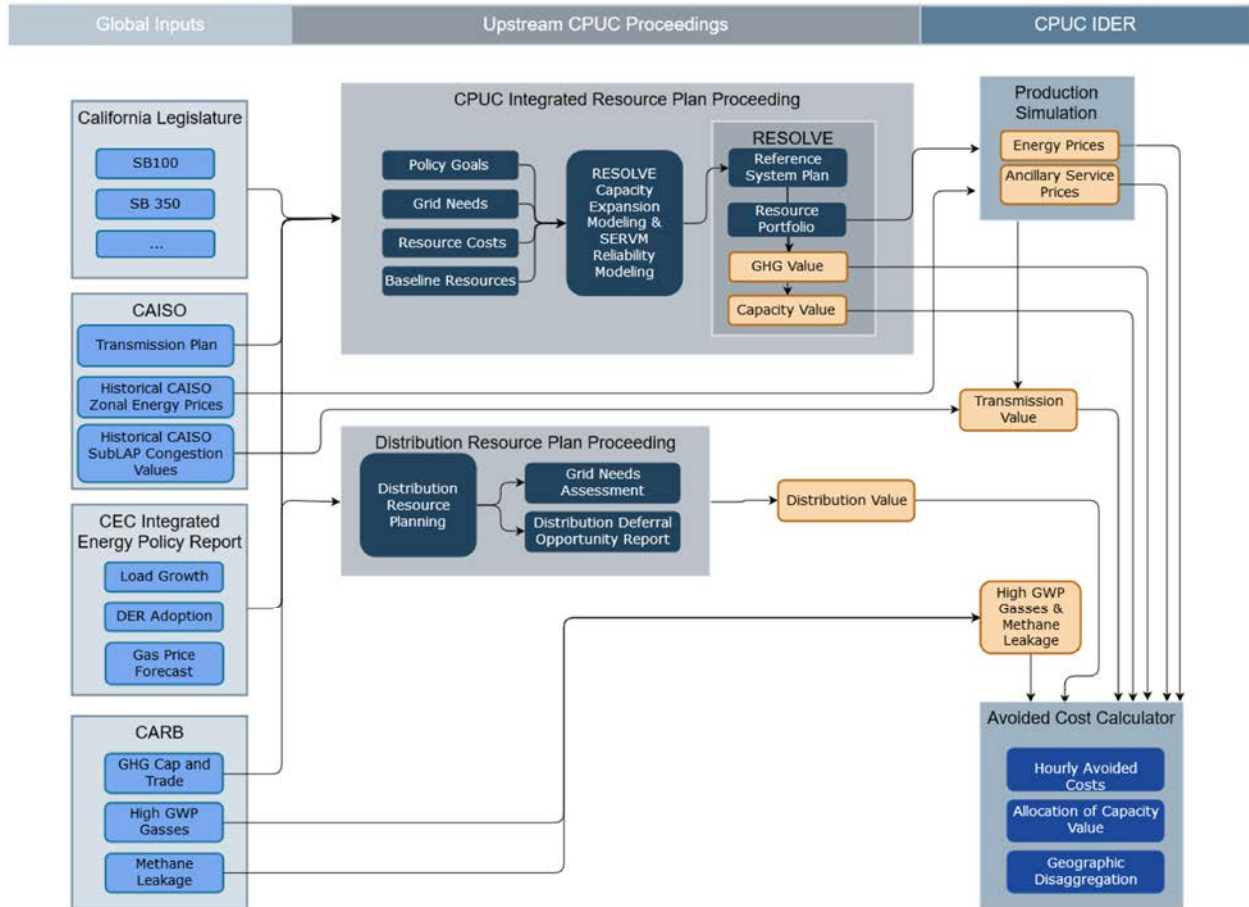
This approach to calculating and using avoided costs is similar to the one proposed by the California Public Utilities Commission (CPUC) Integrated Distributed Energy Resources (IDER) proceeding, as shown in Figure 3-15. In California, the Integrated Resource Planning (IRP) process produces a Reference System Portfolio, which in combination with production





simulation modeling, produces avoided cost streams used to evaluate DER resources in the IDER proceeding.<sup>42</sup>

Figure 3-15: Linkage between avoided costs and capacity expansion and production simulation modeling



### 3.8.2 Other Modeling Outputs

In addition to the Grid Services identified above, the modeling can provide additional information:

1. Longer term forecast outputs could be used to inform interested parties of future needs and allow developers to indicate interest in projects that have a lead time.
  - a. The Grid Needs Assessment may also identify the need to begin developing transmission capacity on the islands. As discussed in Section 3.3, Hawaiian Electric may use IGP results to begin the transmission planning process to develop Renewable Energy Zones.

<sup>42</sup> See Hawaiian Electric’s Response to June 25, 2020 Commission Questions and June 15, 2020 Letter from DER Parties filed on July 2, 2020 in Docket No. 2019-0323.





2. Least-cost dispatch for each resource modeled (*i.e.*, how much of each service is provided by resource type in each operating hour).
3. Other output metrics can be reported or derived from these outputs, such as annual emissions, contributions to RPS and other non-price metrics.



# 4 Solution Evaluation Methodology

---

## 4.1 OVERVIEW & PURPOSE

The Solution Evaluation phase comes after the Grid Needs Assessment phase and after solution options have been proposed by the market via competitive procurements. Solution evaluation also involves utility program development as described in Section 3.7.4, Solution Sourcing. Solution Evaluation methodologies have evolved over the past couple of years based on the Company's experience evaluating solutions through the Stage 1 and Stage 2 RFPs, designing programs in the DER proceeding, and preparations for upcoming procurements such as Stage 3 RFP on the Big Island and the CBRE program. This is an evolving area and the Company will continue to work with the TAP and stakeholders, as well as Independent Observers in various procurements to inform how solutions are evaluated. This section summarizes the latest solution methods that the Company has proposed.

---

## 4.2 SOLUTION EVALUATION MODELING PROCESS

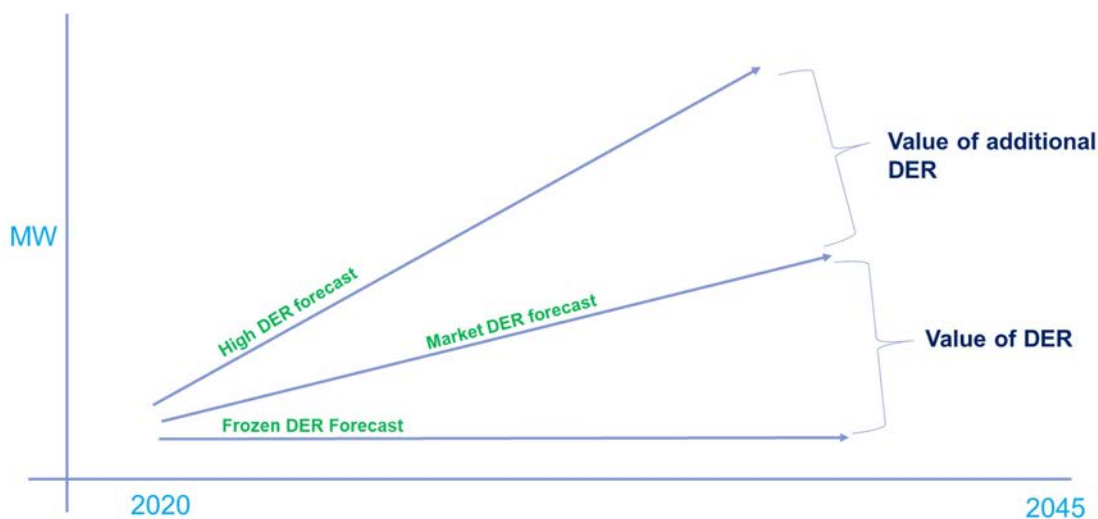
This section describes different ways that could be used to evaluation solutions whether sourced from programs or competitive procurements or even a hybrid of the two approaches.

### 4.2.1 Program Evaluations

The 'Freeze Cases' can be leveraged to inform potential value of achieving the forecasted adoption of a particular technology; similar to the work completed in the DER docket proceeding that led to the creation of the Battery Bonus program. As illustrated in Figure 4-1: Illustration of Values Derived from Freeze Analysis, the energy efficiency, DER, electric vehicle charging layers of the forecast may be evaluated to determine potential value to inform program development that seeks to achieve the levels forecasted.



Figure 4-1: Illustration of Values Derived from Freeze Analysis



The general framework for the Freeze analysis is shown in Figure 4-1. Determining the cost of the system without the forecasted layer (i.e., frozen at current levels) compared to the cost of the system with the forecasted layer effectively provides the approximate value of the addition of the DER resources. In other words, without the forecasted layer, presumably additional resources will need to be built to replace the customer-sited resources assumed in the forecast layer.

The performance characteristics of the resource (i.e., DER capabilities to provide grid services, EV charging profiles, EE measure shapes) are critical to appropriately valuing a program. From a system cost perspective, a program could be deemed cost-effective if the all-in cost of a program is less than the value determined in the Freeze analysis. The design of the program should also reflect the performance requirements and services modeled. Any incentives allocated as part of the program should be performance based to ensure customers are receiving the commensurate benefits.

#### 4.2.2 Programs that Seek Solutions Through Competitive Procurements (Hybrid)

Another option to evaluate solutions is to develop programs that use competitive procurements to acquire program participants. An example of this type of evaluation can be found in the CBRE Phase 2 RFP in Docket No. 2019-0323. A competitive procurement normally will consist of an initial evaluation that considers price and non-price factors, a priority list that combines the price and non-price scoring, and a detailed evaluation to determine a final award group. The following is an illustrative example of a price evaluation designed to fulfill program targets.



#### 4.2.2.1 Initial Evaluation of the Price Related Criteria

An equivalent levelized program capacity price (\$/MW) can be calculated for each solution proposal based on information provided by the solution provider (bidder) including the lump sum payment (\$/year) and the net nameplate capacity of the facility (MW). The proposed solution with the earliest commercial operations date could receive points to reflect the benefits of projects being put into service sooner. Other proposals can then receive points based on chronological order.

The eligible proposal with the lowest levelized program capacity price would receive the maximum points. All other proposals in that evaluation category would receive points based on a proportionate reduction using the percentage by which the proposal's levelized program capacity price exceeds the lowest levelized program capacity price. For example, if a proposal's levelized program capacity price is ten percent (10%) higher than the lowest levelized program capacity price, the proposal will be awarded 10% less points than the maximum. The result of this assessment will be a ranking and scoring of each proposal.

#### 4.2.2.2 Detailed Evaluation to Identify Proposals Selected to a Final Award Group

Once a priority list is determined, a detailed evaluation process could consist of an assessment of combinations of proposals from a priority list. Using a developed base or reference case (i.e., Final Grid Needs Portfolio described in Section 3.7), a capacity expansion model can be used to determine a simplified proxy of benefits and value of proposals of the program portfolio similar to the process described above in Section 4.2.1 (i.e., a resource plan with and without the program portfolio). Proposals will be compared to this proxy value to determine if the proposed projects will provide cost effective value to customers.

Due to computational limitations, all proposals from a priority list may not be evaluated simultaneously. The ranking developed in the initial evaluation can be used to screen the proposals in the detailed evaluation to those that provide the highest potential benefit to the system.

The proxy evaluation will evaluate the benefits and costs of integrating the program portfolio onto the Company's System which includes:

1. The cost to dispatch of the program portfolio and the energy under subject to the appropriate contract;
2. The fuel cost savings (benefits) and any other direct savings resulting from the displacement of generation, including consideration of round-trip efficiencies for facilities with a BESS; and
3. The estimated increase (or decrease) in operating cost, if any, incurred by the Company to maintain system reliability.

Other consideration in the detailed evaluation could include load flow analyses or locational impacts to determine if certain projects or combinations of projects introduce circuit constraints that will factor into the selection process. This is to address the possibility that



even though sufficient line capacity was identified for an individual project, projects that are in close proximity with each other could introduce additional circuit constraints.

The detailed evaluation may consider other factors to ensure that the final combination of projects provides the contemplated benefits that the Company seeks. The Company could consider the implementation of a combination of projects, including consideration of the geographic diversity, program implementation, resource diversity, interconnection complexity, and flexibility and latitude of operation control of the projects.

---

## 4.3 COMPETITIVE PROCUREMENT EVALUATIONS

Another option to evaluate solutions is through a competitive procurement to acquire resources through an all-source procurement. An example of this type of evaluation can be found in the proposed Stage 3 RFP for the Hawai'i Island. A competitive procurement normally will consist of an initial evaluation that considers price and non-price factors, a priority list that combines the price and non-price scoring, and a detailed evaluation to determine a final award group. All-source evaluations are a novel concept given the new technologies that are currently available on the market. The following is an illustrative example of a price evaluation for an all-source procurement.

### 4.3.1 Initial Evaluation of the Price Related Criteria

For the initial price analysis, the Company could complete a levelized price calculation ("LP") for each project based on the proposed energy output and/or capacity using the fixed and variable pricing depending on the technology being proposed.

In order to fairly evaluate solutions or proposals with different technologies and characteristics, solutions can be grouped into technology-based evaluation categories. For example, (1) Wind generation (MWh) only; (2) Wind generation (MWh) and Energy storage; (3) Solar generation (MWh) only; (4) Solar generation (MWh) and Energy storage; (5) Firm synchronous generation; (6) Aggregator generation (MWh).

The proposal with the lowest LP in each evaluation category would receive maximum points. All other proposals in that evaluation category will receive points based on a proportionate reduction using the percentage by which the proposal's LP exceeds the lowest LP in that evaluation category. For example, if a proposal's LP is ten percent (10%) higher than the lowest LP in that evaluation category, the proposal would be awarded maximum points less 10%. The result of this assessment will be a ranking and scoring of each solution or proposal within each evaluation category.



### 4.3.2 Selection of a Priority List

A priority list could be determined by combining the price and non-price scoring which would result in a ranking of Proposals within each technology-based evaluation category. Following the price and non-price scoring, an initial pool of top scoring proposals for each technology-based category and with consideration for electrical location of each resource could be determined. The Company may consider using a computer model to optimize the pool of resources by technology category in order to select proposals in each technology-based category to advance to the priority list.

### 4.3.3 Detailed Evaluation to Identify Proposals selected to a Final Award Group.

Once a priority list is determined, the Company could utilize computer modeling to evaluate the total net cost (cost and benefits) of integrating and operating the portfolio (priority list) onto the Company's system. The portfolio's total net cost could then be compared against the base or reference case.

All solutions or proposals from the priority list could be input into the computer model using the proposal's performance data (i.e., potential energy output, contracted firm capacity), and proposal costs (i.e., lump sum payments, capacity charge payments, energy charge payments, etc.). An optimal, least-cost resource portfolio would then be selected by the computer model. Depending on the number of proposals on the priority list, multiple iterations of the computer model may be needed.

The evaluation could be based on the total net cost (and benefits) to the Company of integrating the combination of priority list proposals onto the Company's System which includes:

1. The cost to dispatch the project or combination of projects and the energy and storage purchased;
2. The fuel cost savings (benefits) and any other direct savings (IPP savings from dispatchable fossil fuel savings, where applicable) resulting from the displacement of generation by the portfolio, including consideration of round-trip efficiencies for proposals with storage; and
3. The estimated increase (or decrease) in operating cost, if any, incurred by the Company to maintain system reliability

Additional analyses of the portfolio may be performed to verify other operating requirements are met (i.e. reliability)

The detailed evaluation may also include load flow analyses to determine if certain projects or combinations of projects introduce line constraints that will factor into the selection process. This is to address the possibility that even though sufficient available MW capacity was identified for an individual project, projects that are in close proximity with each other could introduce additional line constraints.



The detailed evaluation may consider other factors to ensure that the final combination of projects provides the contemplated benefits that the Company seeks. The Company could consider the implementation of a combination of projects, including consideration of the geographic diversity, resource diversity, interconnection complexity, and flexibility and latitude of operation control of the projects.



# Appendix A. RESOLVE & PLEXOS Modeling Description

---

## A.1. INTRODUCTION TO RESOLVE & PLEXOS

As discussed above, the Company proposes to use the RESOLVE model, a capacity expansion model, to create resource plans for the Grid Needs Assessment phase. These resource plans would be verified in PLEXOS, which is an hourly production simulation model.

### A.1.1. CREATING THE RESOURCE PLAN IN RESOLVE MODEL

RESOLVE is a capacity expansion model used to determine an optimal resource plan to meet the 100% renewable energy goal in 2045 and identify the required grid services needed to support the renewable resource portfolio. The model creates a least-cost portfolio, including timing and quantity of resources, to serve the system needs by island over a select set of representative days and a multi-year horizon. RESOLVE also takes into consideration other modeling objectives such as the renewable portfolio standard (RPS) as well as operational requirements, such as energy reserve margin (ERM).

### A.1.2. VERIFYING RESULTS USING PLEXOS

PLEXOS is the production simulation model used by Hawaiian Electric to analyze the least cost dispatch of resources on the electric system and co-optimize resources for the provision of energy and ancillary services.

### A.1.3. MODELING INPUTS

RESOLVE & PLEXOS models use similar data inputs to characterize resources on the system, as summarized in the table below:





Table A – 1: RESOLVE and PLEXOS Inputs

Resource Category	RESOLVE Inputs	PLEXOS Inputs
Thermal/Firm	<ul style="list-style-type: none"> <li>• <b>Fuel Inputs</b> <ul style="list-style-type: none"> <li>○ Fuel type/name</li> <li>○ Fuel cost (\$/MMBtu)</li> <li>○ Fuel GHG content (tCO<sub>2</sub>/MMBtu)</li> <li>○ Fuel burn slope (MMBtu/MW-hr)</li> <li>○ Fuel burn intercept (MMBtu/hr)</li> <li>○ Can blend with biofuel (w/ associated cost adder) (T/F)</li> </ul> </li> <li>• <b>Operating Inputs</b> <ul style="list-style-type: none"> <li>○ Nameplate capacity (MW)</li> <li>○ Unit Pmax rating (MW)</li> <li>○ Unit Pmin rating (% of Pmax)</li> <li>○ Minimum up/down time (hr)</li> <li>○ Startup/shutdown costs (\$/MW)</li> <li>○ Start fuel (MMBtu/start)</li> <li>○ Max ramp up/down (MW/hr)</li> <li>○ Fixed O&amp;M cost (\$/kW-year)</li> <li>○ Variable O&amp;M cost (\$/MWh)</li> </ul> </li> <li>• <b>Ancillary Service Capability</b> <ul style="list-style-type: none"> <li>○ Regulating reserve</li> <li>○ Frequency response</li> <li>○ Inertia</li> </ul> </li> <li>• <b>Capacity Expansion Inputs</b> <ul style="list-style-type: none"> <li>○ Levelized capital cost (\$/kW-year)</li> <li>○ New capacity limit (MW)</li> </ul> </li> <li>• <b>Miscellaneous Inputs</b> <ul style="list-style-type: none"> <li>○ Must-Run (base-loaded) (T/F)</li> <li>○ Must-Commit (T/F)</li> <li>○ Eligible for economic retirement (T/F)</li> </ul> </li> </ul>	<ul style="list-style-type: none"> <li>• <b>Fuel Inputs</b> <ul style="list-style-type: none"> <li>○ Fuel type/name</li> <li>○ Fuel cost (\$/MMBtu)</li> <li>○ Fuel GHG content (tCO<sub>2e</sub>/MMBtu)</li> <li>○ Heat rate (using quadratic <math>a + bx + cx^2</math> where a, b, and c inputs)</li> <li>○ Can blend with biofuel (w/ associated cost adder) (T/F)</li> </ul> </li> <li>• <b>Operating Inputs</b> <ul style="list-style-type: none"> <li>○ Nameplate capacity (MW)</li> <li>○ Unit Pmax rating (MW)</li> <li>○ Unit Pmin rating (MW)</li> <li>○ Minimum up/down time (hr)</li> <li>○ Startup/shutdown costs (\$/MW)</li> <li>○ Start fuel (MMBtu/start)</li> <li>○ Max ramp up/down (MW/hr)</li> <li>○ Fixed O&amp;M cost (\$/kW-year)</li> <li>○ Variable O&amp;M cost (\$/MWh)</li> </ul> </li> <li>• <b>Ancillary Service Capability</b> <ul style="list-style-type: none"> <li>○ Regulating reserve (20-30 minute, 1-minute)</li> <li>○ Frequency response</li> <li>○ Inertia</li> </ul> </li> <li>• <b>Maintenance</b> <ul style="list-style-type: none"> <li>○ Maintenance outage rate (%)</li> <li>○ Repair time (hr)</li> <li>○ Forced outage rate (%)</li> </ul> </li> <li>• <b>Miscellaneous Inputs</b> <ul style="list-style-type: none"> <li>○ Must-Run (base-loaded) (T/F)</li> </ul> </li> </ul>
Variable (including DG PV)	<ul style="list-style-type: none"> <li>• <b>Operating Inputs</b> <ul style="list-style-type: none"> <li>○ Unitized profile</li> <li>○ Variable O&amp;M cost (\$/MWh)</li> <li>○ Is Curtailable (T/F)</li> <li>○ Is RPS Eligible (T/F)</li> </ul> </li> <li>• <b>Capacity Expansion Inputs</b> <ul style="list-style-type: none"> <li>○ Levelized capital costs (\$/kW-year)</li> <li>○ New capacity limit (MW)</li> </ul> </li> </ul>	<ul style="list-style-type: none"> <li>• <b>Operating Inputs</b> <ul style="list-style-type: none"> <li>○ Unitized profile</li> <li>○ Mark-Up (\$/MWh)</li> <li>○ Is Curtailable (T/F)</li> </ul> </li> </ul>



Resource Category	RESOLVE Inputs	PLEXOS Inputs
<b>Standalone Storage</b>	<ul style="list-style-type: none"> <li>• <b>Operating Inputs</b> <ul style="list-style-type: none"> <li>○ Charge/discharge efficiency (%)</li> <li>○ Power rating (MW)</li> <li>○ Energy Capacity (MWh)</li> </ul> </li> <li>• <b>Capacity Expansion Inputs</b> <ul style="list-style-type: none"> <li>○ Levelized capital costs (\$/kW-year &amp; \$/kWh-year)</li> <li>○ New capacity limit (MW)</li> <li>○ Storage duration constraint (minimum or fixed duration for new-built capacity)</li> </ul> </li> </ul>	<ul style="list-style-type: none"> <li>• <b>Operating Inputs</b> <ul style="list-style-type: none"> <li>○ Charge/discharge efficiency (%)</li> <li>○ Power rating (MW)</li> <li>○ Energy Capacity (MWh)</li> <li>○ Cycles (#/year)</li> </ul> </li> </ul>
<b>Paired Variable + Storage</b>	<ul style="list-style-type: none"> <li>• <b>Operating Inputs</b> <ul style="list-style-type: none"> <li>○ Unitized profile</li> <li>○ Charge/discharge efficiency (%)</li> <li>○ Power rating (MW)</li> <li>○ Energy Capacity (MWh)</li> </ul> </li> <li>• <b>Capacity Expansion Inputs</b> <ul style="list-style-type: none"> <li>○ Levelized capital costs (\$/kW-year &amp; \$/kWh-year)</li> <li>○ New capacity limit (MW)</li> <li>○ Storage duration constraint (minimum or fixed duration for new-built capacity)</li> <li>○ Pairing Ratio (MW of paired supply resource / MW of paired storage resource)</li> </ul> </li> </ul>	<ul style="list-style-type: none"> <li>• <b>Operating Inputs</b> <ul style="list-style-type: none"> <li>○ Unitized profile</li> <li>○ Charge/discharge efficiency (%)</li> <li>○ Power rating (MW)</li> <li>○ Energy Capacity (MWh)</li> <li>○ Cycles (#/year)</li> <li>○ Custom constraints (create a custom constraint/rule in PLEXOS stating that battery must only charge from paired generator)</li> </ul> </li> </ul>
<b>DERs</b>	<ul style="list-style-type: none"> <li>• <b>Optional DERs</b> <ul style="list-style-type: none"> <li>○ Flexible loads</li> <li>○ Managed EV charging</li> <li>○ Energy efficiency</li> <li>○ Demand response</li> <li>○ Hydrogen electrolysis</li> </ul> </li> </ul>	<ul style="list-style-type: none"> <li>• <b>Optional DERs</b> <ul style="list-style-type: none"> <li>○ Flexible loads</li> <li>○ Demand response</li> </ul> </li> </ul>

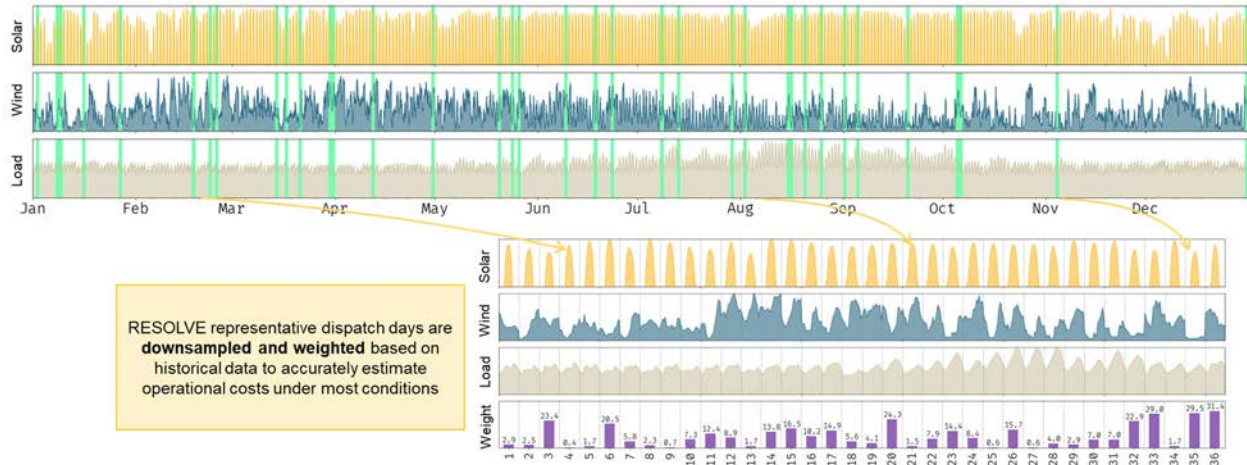
#### A.1.4. LOADS & HOURLY PROFILES

While PLEXOS is a detailed production simulation that models every hour in a year, RESOLVE samples 8760-hour profiles to a representative set of 30-40 days to reduce computation time. These days are weighted and selected based on multiple criteria—most commonly the long-run distribution of gross load, wind, solar, net load, net load ramp, and day type—to estimate



the annual operating costs of the system. This sampling process is shown graphically in Figure A- 1 below:

Figure A- 1: RESOLVE Sampling Process

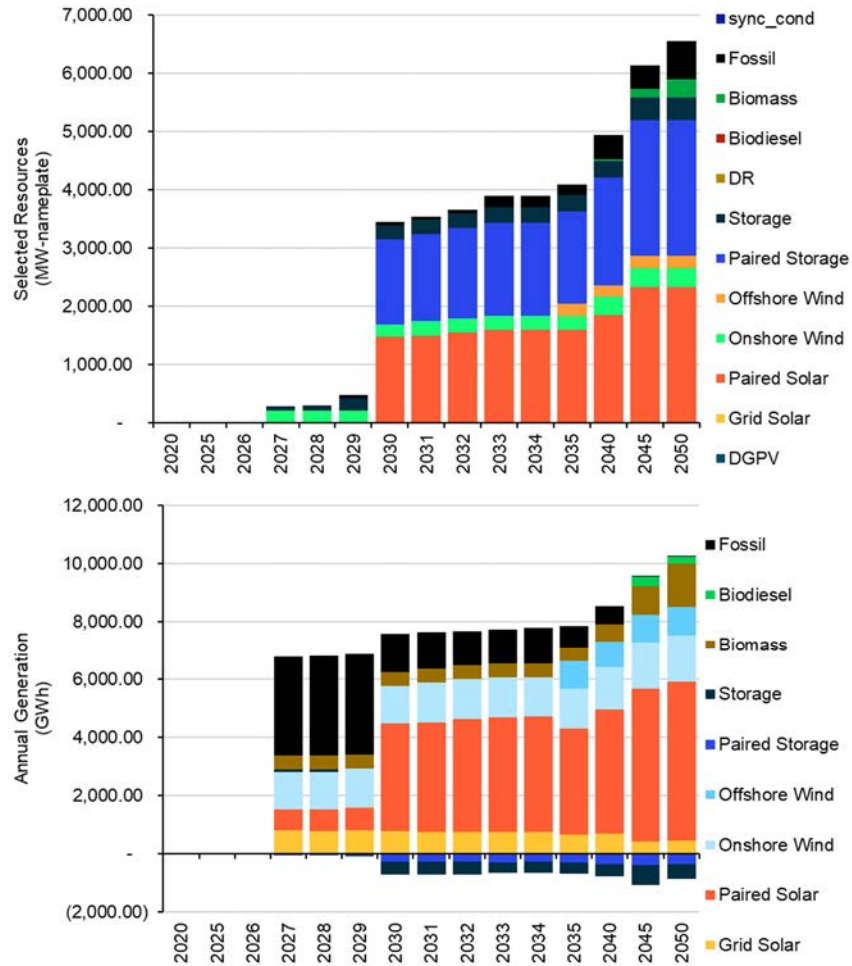


Once the days have been selected and weighted, all hourly profiles are sampled to the representative days—load profiles (both baseline load shapes and load modifiers), EV, DGPV, grid-scale wind, and grid-scale solar resource profiles.

### A.1.5. RESOLVE OUTPUTS

RESOLVE uses a spreadsheet called the Results Tool to extract the modeling results for review and analysis. The Results Tool packages the optimized resource plan in a stacked-bar chart form, with specific MW quantities of resources in additional tables, as shown in Figure A- 2.

Figure A- 2: Illustrative output of RESOLVE Results Tool



Various costs are also produced, including the present value (\$MM) and annual (\$MM/year) incremental fixed costs, total operating costs, total RESOLVE costs, respectively. Total RESOLVE cost represents the total cost of the resource plan. The costs are used as a representative check to compare different scenarios and portfolios that are produced by RESOLVE. The actual hourly total system costs are determined after running the resource plan produced by RESOLVE in the PLEXOS model, which is an hourly production simulation model. RESOLVE’s resource plan is performed in increments of about 5 years for an entire 20-30 year planning horizon, using typical day-weights (not all days of the year are modeled). PLEXOS fills in the details of the proposed resource plan and includes finer tuning of the operational and system constraints.

The model also produces annual effective RPS (%/year), greenhouse gas emissions (MMtCO<sub>2</sub>/year), renewable curtailment (GWh/year), unserved energy (GWh/year), and overgeneration (GWh/year).



### A.1.6. PLEXOS OUTPUTS

PLEXOS generates a solution file that contains many output properties that can be examined. Each property can be examined on the interval level, usually hourly, up to a year. Some of the outputs that are used to characterize a resource plan are generation, fuel costs, unserved energy, and reserve shortage.

The solution file contains the hourly energy generation (MWh) for all generators modeled on the system. The yearly energy generation of each system is used to determine system costs.

Fuel costs of the system are based on the fuel offtake of the generator multiplied by the price of that fuel. Costs for startup fuels are also included in the model but are separated to allow the use of a different start up fuel.

Unserved energy (MWh) and Shortage (MW) are important outputs that measure whether an adequate amount of grid services were made available in the model. Unserved energy is the amount of load that was not able to be served due to a lack of available resources. Shortage is the amount of reserve that was require but not by available resources.



# Appendix B. Model Input Definitions

## B.1. DEFINITIONS FOR VARIOUS MODEL INPUTS

The table below describes the various inputs that can be captured in the RESOLVE and PLEXOS models. Detailed workbooks of assumptions currently assumed in the modeling for O'ahu, Hawai'i Island, Maui, Moloka'i, and Lāna'i, are available under "Inputs and Assumptions" at <https://www.hawaiielectric.com/clean-energy-hawaii/integrated-grid-planning/stakeholder-engagement/key-stakeholder-documents>.

Table B – 1: Model Input Definitions

INPUT			
Property Name	Description	Unit	Category
<b>Generator Inputs</b>			
Bid-Cost Mark-up	A modifier to offer price to influence the order units are dispatched. NOTE: Offer price is not actually used when calculating costs of the system.	%	Generator
Mark-up	A modifier to offer price to influence the order units are dispatched. NOTE: Offer price is not actually used when calculating costs of the system.	\$/MWh	Generator
Commit	Number of units on a generator that must be used when it is available. NOTE: This is a fixed commitment and not minimum		Generator
Forced Outage Rate	Annual expected levels of unplanned outages	%	Generator
Maintenance Rate	Annual expected levels of planned outages	%	Generator
Heat Rate Base	Heat rate is defined by $a + bx + cx^2$ This is a 'a' term of the equation	-	Generator
Heat Rate Incr	Heat rate is defined by $a + bx + cx^2$ This is a 'b' term of the equation	-	Generator



INPUT			
Property Name	Description	Unit	Category
Heat Rate Incr2	Heat rate is defined by $a + bx + cx^2$ This is a 'c' term of the equation	-	Generator
Max Capacity	Max power of each unit on a generator	MW	Generator
Max Ramp Down	Limit on the amount that generation can decrease	MW/min	Generator
Max Ramp Up	Limit on the amount that generation can increase	MW/min	Generator
Mean Time to Repair	How long outages will take	hrs	Generator
Repair Time Distribution	Distribution used to generate repair times	-	Generator
Min Up Time	Minimum number of hours the unit must be run after being started	hrs	Generator
Min Stable Level	Unit minimum power, not including ramp-up and ramp-down	MW	Generator
Random Number Seed	Random number seed assigned to the generator for the generation of outages	-	Generator
Rating Factor	Maximum dispatchable capacity of each unit expressed as a percentage of Max Capacity	%	Generator
Start Cost Time	Incremental cooling time over which the corresponding Start Cost applies	hrs	Generator
Units	Number of installed units	-	Generator
Units Out	Number of units out of service		Generator
Fuel Inputs			
Price	Fuel price	\$/MMBTU	Fuel
Is Available	Flag if fuel exists	0 or 1	Fuel
Is Enabled	Flag if the reserve is enabled	0 or 1	Reserves
Min Provision	Minimum required reserve	MW	Reserves



INPUT			
Property Name	Description	Unit	Category
Timeframe	Timeframe in which the reserve is required	Seconds	Reserves
Type	Type of reserve, i.e., Raise, Reg, Replacement		Reserves
VoRS	Value of reserve shortage		Reserves
Battery Inputs			
Capacity	Energy the battery can store	MWh	Batteries
Charge Efficiency	Efficiency of charging the battery	%	Batteries
Discharge Efficiency	Efficiency of discharging the battery	%	Batteries
Initial SoC	Initial state of charge of the battery at the start of the run	%	Batteries
Maintenance Rate	Expected levels of unplanned outages	%	Batteries
Max Cycles Year	Max cycles the battery is allowed to use in a year	Cycles	Batteries
Max Power	Max power the battery can generate excluding inverter losses  i.e., If Max power is 100MW with 99% discharge efficiency, total effective power is 99MW	MW	Batteries
Max SoC	Maximum state of charge	%	Batteries
Min SoC	Minimum state of charge	%	Batteries
Mean Time to Repair	How long the outages will take	%	Batteries
Random Number Seed	Random number seed assigned to the generator for the generation of outages	-	Batteries
Units	Number of BESS units installed		Batteries
VO&M Charge	Variable operation and maintenance charge	\$/MWh	Batteries
Region Input			
Load	System Load	MW	Region





INPUT			
Property Name	Description	Unit	Category
Fixed Load	Additional load added to Load Used for different layers	MW	Region
Price of Dump Energy	Price of energy in excess of total load	\$/MWh	Region
VoLL	Value of unserved load Usually quite high so that to deter model from having unserved energy.	\$/MWh	Region
Load Participation Factor	Proportion of region load that occurs at this node	Between -1 and 1	Nodes
Penalty Price	Price for violating the constraint	\$	Constraints
RHS	Right hand side of inequality equation		Constraints
LHS	Left hand side of inequality equation		Constraints
Sense	Type of inequality for constraint	$\leq, \geq, =$	Constraints



# Appendix C. Energy Reserve Margin Criteria

---

## C.1. UPDATES TO CAPACITY PLANNING CRITERIA

The function of a planning criteria is to establish guidelines to minimize the risk of insufficient generation capability from a diverse mix of generating resources available to the system in long-range generation expansion studies. Resource plan development is evaluated based on a consistent guideline or criteria to provide adequate generation to meet customer demand, with reasonable reserves to account for routine maintenance or overhauls of units, unexpected outages of generating units, growth in customer demand over time, and possibilities of higher than forecasted instantaneous peak demand. Because each island has an isolated electrical system, and is not interconnected to other utilities, it has been necessary to consider different planning criteria than mainland utilities.

### C.1.1. CURRENT PLANNING CRITERIA

Hawaiian Electric's capacity planning criteria for the island of O'ahu consists of one rule and one reliability guideline. Capacity planning criteria for the islands of Maui and Hawai'i Island consist of one rule, with consideration given to maintaining a reserve margin of approximately 20 percent. The islands of Lāna'i and Moloka'i generally follow the planning criteria rule consistent with O'ahu, Maui and Hawai'i Islands.

The current capacity planning rule states:

The total capability of the system must at all times be equal to or greater than the summation of the following:

- a. The capacity needed to serve the estimated system peak load, less the amount of interruptible loads;
- b. The capacity of the unit scheduled for maintenance; and
- c. The capacity that would be lost by the forced outage of the largest unit in service.

However, with the increasing quantities of variable renewable wind and solar resources, and future energy storage additions to the system, Hawaiian Electric's current planning rule and guidelines do not account for the dynamic nature of variable resources and limited duration storage.



## C.1.2. ENERGY RESERVE MARGIN

Reliability planning criteria for utilities long-range generation expansion planning varies among different jurisdictions, and includes criteria such as, but not limited to, loss of largest unit, loss of load expectation, expected unserved energy, loss of load probability, and reserve margin percentages. An energy reserve margin (“ERM”), similar to a capacity reserve margin, was selected as a means to establish guidelines to minimize the risk of insufficient generation capability from a diverse mix of generating resources available to the system in Hawaiian Electric’s long-range generation expansion studies. Using an energy reserve margin planning criteria is intended to provide enough energy resources for safe and reliable service to customers and to serve future system needs.

Hawaiian Electric’s energy reserve margin planning criteria concept and target reserve margins are intended to mitigate individual and concurrent contingencies based on historical occurrences and other plausible situations, such as, but not limited to, generating outages, abnormal load and weather conditions that provides, at a minimum, the same level of reliability as the current system. However, the energy reserve margin is not intended to cover all possible scenarios or extreme events that may occur. The Company’s energy reserve margin concept is different than its previously used loss of largest unit criteria or probability based criteria such as a 1 day in 10 years, or O’ahu’s 4.5 years per day metric. Energy reserve margin is an evolution of these past criteria to now account for system specific characteristics, changing resource mixes that includes large inverter-based variable renewable and storage additions, and hourly reliability needs.

Energy reserve margin targets for O’ahu, Maui, and Hawai’i Island were set to 30% as an initial criterion as described herein. As part of the Company’s Integrated Grid Planning process, further analyses were completed to study the impact of different energy reserve margin target percentages to determine appropriate planning targets for each island in response to stakeholder feedback.

Initial planning targets were developed based on the Company’s analysis conducted for each island to ensure that the level of reliability is consistent with the level of reliability under previous loss of largest unit criteria, reserve margin at system peak planning considerations, and loss of load probability planning consideration as it applied to Hawaiian Electric’s Oahu system. Notably, the TAP’s independent review of the energy reserve margin agreed that the “ERM is a reasonable approach to take. However, there should be clarity on how values are reached and how different grid resources are considered in analyses.”<sup>43</sup> This recommendation was based on the TAP’s assessment that “HECO is correct to identify a need to change the conventional planning reserve margin used in previous planning efforts with a new methodology that evaluates all hours of the year and chronological operations of the grid.”<sup>44</sup>

---

<sup>43</sup> Grid Services and Planning Criteria Feedback filed on June 1, 2021 in Docket No. 2018-0165 at 10.

<sup>44</sup> Id. at 9.



### C.1.3. DEFINITIONS

#### Available Unit

Unit which is capable of providing service, whether or not it is actually in service, regardless of the capacity level that can be provided.

#### Normal Net Capability Rating: (N<sub>1</sub>, N<sub>2</sub>, N<sub>3</sub>... NN)

- a. For applicable firm capacity units such as steam units, combustion turbines, and internal combustion engines, this is the maximum net load the units are capable of carrying continuously on a day-to-day basis. This is the maximum net load to which the unit is normally dispatched.
- b. Firm capacity provided by other suppliers is represented as generating units with normal net capability ratings, consistent with the intent of these definitions and applicable power purchase agreements.

#### Hourly Dependable Capacity

The Hourly Dependable Capacity (“HDC”) is the minimum expected capacity from variable generation resources based on empirical data. The HDC (MW) is calculated for each hour as follows:

$$\text{HDC}_{\text{hr}} = \chi - N * \sigma,$$

where

- $\chi$  = the mean,
- $\sigma$  = a standard deviation,
- N = the number of standard deviations

#### Shifted Load

The energy charged and discharged by energy storage systems in each hour. Energy storage systems that shift load include but are not limited to utility scale batteries and batteries paired with renewable resources. Shifted load may include customer owned energy storage systems that could shift load per the terms of their particular tariff or distributed energy program.

#### Interruptible Load

The reduction of customer loads to support system capacity needs, for example, demand response programs that can reduce system load when needed, or tariffs that allow changes in load.

#### Energy Reserve Margin



The Energy Reserve Margin is the percentage of system load by which the system capacity must exceed the system load in each hour. The energy reserve margin for each island is listed in the table below.

Table C - 1: Energy Reserve Margin Percentages by Island

Island	Energy Reserve Margin
O`ahu	30%
Hawai`i	30%
Maui	30%
Moloka`i	60%
Lāna`i	60%

Energy reserve margins are derived from an assessment of historical data. Identified 'at risk' hours were evaluated to determine minimum energy reserve targets for planning purposes. The loss of largest unit, multiple forced outages, and unplanned maintenance were some of the largest contributing factors for hours considered to be at-risk. Energy reserve margin targets plan for the loss of largest unit and an additional hourly reserve for emergencies. However, it does not directly assign specific reserves to cover different events discretely. The ERM is intended to mitigate a variety of risks including the loss of the largest unit. As an example of the dynamics, the loss of a 180 MW (largest) unit for a peak load of 1,200 MW represents 15%; the loss of the same unit during a shoulder peak load of 600 MW represents 30%. Therefore, the ERM does not explicitly allocate a percentage to the loss of the largest unit and the other portion to other specific type of events that may occur.

The size of generating units on each island are contributing factors to energy reserve margin targets. For instance, on Moloka`i and Lāna`i, the largest generating units on the island have the capability to produce roughly 60% of each island's average daily energy usage. For comparison to the current planning criteria described above, which is to meet the peak load with the loss of the largest available unit, the 60% energy reserve margin target for Moloka`i and Lāna`i is to plan for resources that can generate enough energy throughout the day to meet the island's energy load without the largest available unit.

#### C.1.4. RESOURCE ADEQUACY METRICS

The PLEXOS modeling software will be used to complete the detailed reliability assessment. At minimum, the Company will assess the resource plan from RESOLVE to determine if the energy reserve margin criteria is satisfied over the planning horizon.

In consultation with the TAP, a stochastic analysis may be performed for the base plan and potential key sensitivities in key critical years to quantify if a portfolio meets a reliability



criterion across every hour of the year analyzed. The reliability metrics that are assessed may include:

- Loss of load expectation (LOLE)
- Loss of Load Hours (LOLH)
- Expected Unserved Energy (EUE)

While these metrics are established measures of reliability, different standards are used by utilities and system operators regionally.<sup>45</sup> Hawaiian Electric has not adopted set standards for each of the metrics. However, because the capacity expansion analyses will already solve for the ERM target as part of the resource build out decisions to meet the forecasted system load plus margin, expected unserved energy is expected to be minimized and a natural output of the modeling analyses that can be used to assess reliability.

Detailed stochastic analyses are more critical in evaluating near-term reliability; however, over longer-term horizons, the larger uncertainty in the underlying forecasts makes detailed stochastic analyses less meaningful.

The stochastic analysis incorporates wind, solar, and net load variability, and random generator outages to quantify unserved load. Typically, simplifications of grid operations for generating and other unit properties are assumed for these types of analyses.

Outputs from a detailed reliability analysis may include size, frequency, and duration of capacity shortfall, which may be used to adjust or iterate the reliability requirement or adjust resource mix derived from the capacity expansion plan. These outputs are captured in the reliability metrics proposed for this assessment.

### C.1.5. GENERATION ADDITION RULE

New generation will be added to prevent the violation of the rule listed below. Available units include available Hawaiian Electric and independent power producer units and facilities.

The sum of the amount net capability ratings of all available units minus planned maintenance, plus Hourly Dependable Capacity, plus shifted load by energy storage, plus interruptible loads must be equal to or greater than the system hourly load multiplied by the quantity of one plus the Energy Reserve Margin.

$$\sum N_i - \text{Maintenance} + \text{Hourly Dependable Capacity} + \text{Shifted Load} + \text{Interruptible Load} \geq \text{System Hourly Load} * (1 + \text{Energy Reserve Margin})$$

<sup>45</sup> See <https://www.nysrc.org/PDF/Reports/Resource%20Adequacy%20Metric%20Report%20Final%204-20-2020%5B6431%5D.pdf> at 9



The rule above, applies to resource planning in long-range generation expansion studies. The timing of generating resource additions should be examined using these rules as guides, with due consideration given to short-term operating conditions, equipment procurement, construction, financial and regulatory constraints.

### C.1.6. PLANNING CONSIDERATIONS FOR AN ENERGY RESERVE MARGIN

Hawaiian Electric decided to use an energy reserve margin as a means of incorporating a robust capacity planning criteria in its long-term planning processes. Although several utilities use a loss of load expectation (“LOLE”) criteria for capacity planning, the probabilistic analyses to support a robust LOLE calculation with very high quantities of variable generation and energy storage resources would be difficult to integrate into a capacity expansion model.

When considering the capacity accreditation of variable renewables toward the ERM criteria (to meet system demand), the HDC framework was preferred over other approaches like Effective Load-Carrying Capability (ELCC). HDC does not depend on assumed load profiles, maintenance schedules, and resource mix of the system and can be calculated independent of the other generators in the portfolio. The intent of HDC is to plan for a different variable resource capability in every hour and could be described as an hourly ELCC. Its derivation allows for a granular analysis of weather variability and reliability of generation from variable renewable resources in each hour. As recorded variable renewable data changes, new data can be easily incorporated to update the HDC values and would not require a system level analysis like the ELCC.

As significant quantities of hybrid solar plants (solar paired with energy storage) are integrated into the system, the Company will collect actual production data that can inform and improve the accreditation of these new hybrid systems. Currently, best estimates are being used to estimate their output, based upon historical solar data and its availability to charge a battery energy storage system. However, there are assumptions being made as to how a battery energy storage system will actually be used to meet reliability needs. For instance, the hybrid resources under contract have a single interface to system operations; that is, system operators will not directly control an energy storage system and solar output. Rather, a single point will be controlled with a request for certain MW output. There is a presumption that where solar generation may exist in excess of the requested output, that the energy storage system will charge and store the excess – operators do not directly control the operations of the energy storage system. There is also uncertainty in how batteries will be managed in real-time operations given the multitude of services that it may provide throughout the day that could impact the available state of charge of the during times of high stress. For example, the hybrid plants will provide regulation and frequency response services that may be in conflict for the need to serve load during peak times because batteries are energy limited and cannot generate power on their own.



The HDCs are defined by resource type using historical production data. To the extent that future variable renewable projects are clustered in different parts of the islands, the HDC could be defined regionally once an established record of production data is generated. Using the historical production data, the times where the PV and wind production was coincident with the peak demand would be reflected in the HDC values. However, if the generation during those periods was highly variable, the HDC value could be low when subtracting one or two standard deviation from the mean production for that hour.

The Energy Reserve Margin criteria is a capacity planning criteria that accounts for capacity needs on an hourly basis and incorporates the capacity contributions from a wide variety of resources. As the Company develops its long-term resource plans, the portfolio of resources that provide capacity to the system may change over the planning horizon. Recent procurements will introduce large amounts of variable renewables paired with energy storage that will displace generation from conventional fossil fuel generators and the Company's planning criteria needs to adapt to account for the contributions from these variable resources and energy limited resources. These types of resources also introduce challenges in capacity planning where capacity needs may result from energy limitations, including duration limits on energy storage and the variable production of variable renewables, that manifest in capacity needs occurring in off peak periods. Traditionally, capacity planning has been focused on meeting annual system peak but as the resource portfolio changes, capacity needs may occur in different seasons and times of day as the availability from energy limited resources changes.

Recognizing the challenges described above, the ERM does explicitly consider certain components in its calculation: firm system capability, planned maintenance for thermal generators, shifted load from energy storage systems, and interruptible load from demand response. However, the Company has built in safety margins and risk mitigation to certain components. This includes the hourly dependable capacity and contingencies that are covered through the ERM margin. The hourly dependable capacity reduces the capacity credit from variable renewable resources that is counted toward meeting the ERM capacity planning criteria due to limited historical records for existing projects, near term additions of large hybrid solar and energy storage plants that are an entirely new resource with which to develop operational experience, and uncertain impacts of climate change on the future production of variable renewable resources. The contingencies considered in the energy reserve margin include forced outages of thermal units as well as full plant outages of inverter based resources such as PV, wind, and storage.

### C.1.7. DERIVATION OF THE ERM

The energy reserve margin targets of 30% for O'ahu, Hawai'i Island and Maui, and 60% for Lāna'i and Moloka'i were derived from an assessment of historical data, and planning criteria previously used by the Company for loss of largest unit and LOLP. Increasing quantities of variable renewable resources, and planned energy storage additions to the system have driven the need to develop planning criteria that accounts for the dynamic nature of variable and





limited duration resources compared to traditional generators that are typically able to supply energy any time of day. The energy reserve margin concept was developed to plan for increasingly diverse generation portfolios and technologies.

Energy reserve margin targets plan for reserves to support a range of contingencies including:

- Forced outages of generating units
- Unplanned generator maintenance
- Fluctuations in generation from variable resources
- Prolonged weather patterns or atypical weather events
- Battery energy storage failures or outages
- Forecast error, especially higher than forecasted load conditions

Adhering to past criterion has allowed the Company to provide safe and reliable energy for many years. As the generating portfolio on each island is evolving, so to must the planning criteria to provide at least the same level of reliability. In its assessment of the energy reserve margin, the TAP agreed that “[a] reliability criterion that only evaluates peak load is inadequate for a system with high percentage penetrations of variable renewables and energy limited resources (storage and load flexibility). ERM is a step in the right direction.”<sup>46</sup>

For reference, Table C - 2 shows the Company’s previous planning criteria that consisted of one rule and planning considerations.

Table C - 2: Previous Planning Criteria and Consideration

Island	Planning Criteria	Planning Consideration
Oahu	Loss of Largest Unit	4.5 yrs/day Loss of Load Probability
Hawaii	Loss of Largest Unit	20% reserve margin
Maui	Loss of Largest Unit	20% reserve margin
Lanai	Loss of Largest Unit	
Molokai	Loss of Largest Unit	

The above criteria in conjunction with available historical data was used to derive energy reserve margins targets for the reliability challenges unique to each island. Due to the different generating resource types, prior planning criteria and considerations for different

<sup>46</sup> Grid Services and Planning Criteria Feedback filed on June 1, 2021 in Docket No. 2018-0165 at pages 9-10



islands, and available historical data on each island, energy reserve margin target development testing evolved differently for different islands.

Annual assessments based on calculations at the annual peak were a limitation of previous planning criteria. If there was sufficient generating capacity for the highest load of the year, it was reasonable to expect that lower loads could be served throughout the year since thermal generators, if available, typically would be able to provide energy and capacity in any hour of the day. However, generating resources on each island are transitioning to include increasing amounts of variable generation, storage, and load management programs which requires evaluation of non-peak hours.

As generation resources evolve, the availability from dynamic, variable generation as well as the load shifting capabilities of energy storage systems must be recognized.

### C.1.8. INITIAL ERM EVALUATION

The previous planning criteria consisted of a loss of largest unit criteria, often referred to by the Company as “Rule 1”, states that the total capability of the system must always be equal to or greater than the summation of the following:

- a. the estimated system peak load, less the total amount of interruptible loads;
- b. the capacity of the unit(s) scheduled for maintenance; and
- c. the capacity that would be lost by the forced outage of the largest unit in service.

The contingency event addressed by the loss of largest unit or Rule 1 criteria is important to consider in the energy reserve margin planning criteria, given the system-wide impacts that such an event could have on customers. The loss of largest unit criteria, as previously implemented, focused only on the effects of the loss of the largest unit at the peak hour of the year. This criteria was repurposed to emphasize the energy availability that would typically be provided from a large generating resource to be resource agnostic for capacity expansion planning purposes because the ability to provide replacement energy for the loss of largest unit was of equal concern as the ability to provide replacement capacity. In developing the energy reserve margin to incorporate the loss of the largest unit, a simplified conversion of the energy that the largest unit on each island can provide in proportion to the daily energy requirements is shown in the Table C - 3 below. By having an energy reserve margin target equal or greater to the required energy percentage shown in the table, each island should have sufficient capacity to serve load on an average load day with low solar and wind conditions and with the largest unit on forced outage throughout the day. The required energy percentage is treated as a minimum level that each island’s energy reserve margin should meet or exceed.



Table C – 3: Island Largest Unit

Island	Average Daily Load (MWh 2019)	Largest Unit (MW)	Largest Unit Daily Energy (MWh)	Energy (%)
O'ahu	17,981	180	4,320	24%
O'ahu (Post-AES Coal)	17,981	142	3,408	19%
Hawai'i	3,062	38	912	30%
Maui	3,065	28	681	22%
Lāna'i	94	2.2	53	56%
Moloka'i	89	2.2	53	59%

It should be noted that planning for the loss of the largest unit represents one type of risk for the system. The energy on the system needed to mitigate this risk as well as other energy reliability risks can be provided from *any* sufficiently reliable resource that can generate energy or provide reserve energy at the time a system event occurs and is not constrained to only thermal generating units, as was traditionally considered in the past.

#### C.1.8.1. O'ahu

O'ahu's largest unit, currently the AES Hawaii 180 MW coal unit, represents approximately 16% of typical peak load demand by MW, and about 24% on an energy potential basis. In September 2022, the AES Hawaii power purchase agreement will expire. After September 2022, O'ahu's largest unit will be Kahe 5 or Kahe 6 at 142 MW each. Kahe 5 or Kahe 6 represents approximately 12 % of typical peak load demand and about 19% on an energy potential basis. The loss of largest unit and considerations for historical reserves discussed below were the determining factors for O'ahu's 30 % energy reserve margin target.

Historical 2016-2018 data for O'ahu was reviewed to find periods when the system experienced low levels of reserves. For this review of historical reliability levels, reserves were examined with the loss of the largest generating unit. The data showed that when the system experienced higher risk of capacity shortfalls, the reserves were found to fall to less than 15% of the system load after a reduction for the possibility of losing the largest generating unit. For



example, on September 26, 2018, reserves would have been as low as 12.8% of the system load of 1,147 MW with three generating units on maintenance and derates of multiple units. Additional generation loss from units experiencing forced outages caused reserves to fall even further. If the loss of an additional large generating unit occurred, there would have been insufficient generation that could have resulted in load shed or blackout conditions.

O’ahu’s 30% energy reserve margin target is intended to establish a minimum energy reserve level approximately equivalent to the sum of a 15 % minimum reserve and the 12-16% capacity of the largest generating unit.

The use of a loss of load probability (“LOLP”) analysis as a planning consideration has been unique to the island of O’ahu. As with other previous criteria, LOLP determined the probability of insufficient generation capacity at the time of the daily peak. Loss of load probability analyses include projected forced outage rates in addition to the planned maintenance, thereby addressing unit availability for firm generation. LOLP analysis results for O’ahu were evaluated and compared to corresponding energy reserve margin levels. Table C - 4 below is a conversion of the LOLP analysis found in Hawaiian Electric’s 2021 Adequacy of Supply report to an equivalent energy reserve margin level meeting O’ahu’s previous 1 day in 4.5 years criteria and a 1 day in 10 years industry standard LOLP reliability criteria. The equivalent margin level (approximately 34-36% of energy reserves) of 1 day in 4.5 years LOLP criteria results in targets higher than Oahu’s 30% energy reserve margin target.

Table C - 4: Oahu Reserve Margin

Estimated Energy Reserve Margin Level		
Year	Energy Reserve Margin Level Based on LOLP Reference Case 1 day in 4.5 years Without Stage 1&2 RFP Projects Without Kapolei Energy Storage	Energy Reserve Margin Level Based on LOLP Reference Case 1 day in 10 years Without Stage 1&2 RFP Projects Without Kapolei Energy Storage
2021	34%	36%
2022	36%	38%
2023	34%	36%
2024	34%	36%
2025	34%	36%



The equivalent energy reserve margin level of the O’ahu LOLP reliability criteria was analyzed by taking the annual surplus or shortfall MW’s from the 2021 Adequacy of Supply loss of load probability analysis as shown below in Table C - 5 and applying the surplus or shortfalls as an hourly fixed load for each year in an energy reserve margin analysis. The energy reserve margin level was then determined by varying the hourly load by an incremental percentage and identifying the highest energy reserve margin percentage level without any unserved energy.

Table C – 5: O’ahu Loss of Load Probability Surplus and Shortfalls

<b>Loss of Load Probability Surplus/Shortfalls</b>		
	4.5 years/day Without Stage 1&2 RFP Projects Without Kapolei Energy Storage	10 years/day Without Stage 1&2 RFP Projects Without Kapolei Energy Storage
2021	20 MW	-10 MW
2022	-30 MW	-70 MW
2023	-150 MW	-180 MW
2024	-140 MW	-170 MW
2025	-180 MW	-210 MW
(Note: Negative values indicate a shortfall of generating capacity; positive values indicate a surplus of generating capacity)		

Based on benchmarking the 4.5 years/day LOLP criteria against energy reserve margin, 30% is a reasonable guideline; however, the benchmarking would suggest that a higher energy reserve margin may be warranted for O’ahu because of capacity shortfalls identified in 2022 through 2025. The methodology used for this LOLP analysis is consistent with the Company’s Adequacy of Supply reports. Paired and standalone BESS were not included in this analysis due to the uncertain treatment of those resources toward meeting the system peak under an LOLP methodology. LOLP may not fully consider the performance characteristics of energy limited resources on the system, which may cause shortfalls in periods outside of the system peak due to insufficient energy to charge the BESS.



### C.1.8.2. Hawai'i Island

On Hawai'i Island, the largest unit for planning purposes is the Puna Geothermal Venture (PGV) 38 MW plant and could account for approximately 30% Hawai'i Island's daily energy needs. The energy reserve margin target was developed based on the amount of generation that could be provided by the largest unit in proportion to the load such that the magnitude and frequency of unserved energy is minimized.

Table C - 6 below illustrates the amount of unserved energy on the island in proportion to system load under varying energy reserve target percentages that could mitigate the effects of the loss of largest unit on Hawai'i Island. For Hawai'i Island, energy reserve margin levels greater than 30% were found to have diminishing returns on system reliability. The unserved energy, load and hours of unserved energy are a summation over a 24-year evaluation period.

Table C - 6: Hawai'i Island Unserved Energy

	Loss of Largest Unit Reserve Requirement (Hawaii Island)				
	10%	20%	30%	35%	40%
Energy Reserve Margin	10%	20%	30%	35%	40%
Unserved Energy in Proportion to Load	0.0106%	0.0009%	0.0001%	<.0001%	<.0001%
Hours With Unserved Energy	261	35	2	1	0

### C.1.8.3. Maui

On Maui, the largest unit for planning purposes is one half of a dual-train combined-cycle unit (e.g., one combustion turbine and half of the steam turbine) at the Maalaea Power Plant, or about 28 MW. Past calculation of Maui's loss of largest unit largest unit indicated one half of a dual-train combined-cycle is nearly 20% of Maui's generating capability needed to serve its load and could account for approximately 22% of daily energy potential. An energy reserve margin of 20% was considered to closely match Maui's previous loss of largest unit planning criteria, however, operational experience has shown the challenges in performing maintenance on larger units due to insufficient generation capability to serve all customer needs. The Company's review of Maui's criteria suggested Maui should plan for similar energy reserves as O'ahu and Hawai'i Island's criteria. In order to plan for equivalent energy reliability levels on Maui as has been determined for Oahu and Hawaii, Maui's energy reserve margin is 30% for consistent energy reserve levels, and to plan for similar reliability.



#### C.1.8.4. Lānaʻi

On the islands of Lānaʻi and Molokaʻi, as shown in , about 60% of the daily average load could be served by the largest 2.2 MW units on the islands. To test energy reserve levels needed to mitigate the loss of the largest unit on Lānaʻi, forecasted load assumptions were used to test the efficacy of 60% energy reserve margin targets on future resource plan developed for Lānaʻi in the Company's Power Supply Improvement Plan December 2016 Update. The analysis indicated Lānaʻi's resource plan is sufficient to meet the 60% energy reserve margin except in 2032, 2038, 2041 and 2044, with small shortfalls occurring in these years. Note Lānaʻi's Power Supply Improvement Plan December 2016 Update long term resource plan was based on 30% planning reserve margin criteria at system peak but created resource plans that provide similar reliability as a 60% energy reserve margin planning criteria.

#### C.1.8.5. Molokaʻi

To test energy reserve levels needed to mitigate the loss of the largest unit on Molokaʻi, similar to the analysis performed for Lānaʻi, forecasted load assumptions were used to test the efficacy of 60% energy reserve margin targets on future resource plan developed for Molokaʻi in the Company's Power Supply Improvement Plan December 2016 Update. Molokaʻi has a surplus of generating resources that is anticipated to cover Molokaʻi's energy needs into the future. Planning for 60% energy reserve margin criteria for loss of largest unit is sufficient to ensure energy reliability for Molokaʻi.

#### C.1.8.6. Stress Testing Energy Reserve Margin Targets

Energy reserve margin targets are intended to plan for sufficient energy reserves to provide for a reliable system over a range of conditions and maintain a reasonable tolerance to worsening contingencies.

To study if energy reserve margin targets can maintain system reliability under new or worsening system conditions, the effectiveness of energy reserve margin targets were tested under an array of contingencies.

The contingencies were introduced to the model individually and simulated probabilistically where applicable. The efficacy of the proposed targets at preventing unserved energy in the event of each contingency was observed for each island. The proposed targets were found to be an acceptable mitigation measure if the application of the energy reserve margin was sufficient to prevent unserved energy in *any* hour during the contingency being tested. It should be noted that the contingencies were evaluated under isolated conditions, and not as simultaneous events. The energy reserve margin stress testing was not intended to mitigate all combinations and permutations of contingencies, but rather to provide a measure of system



conditions impacts on system integrity. It is possible that the proposed energy reserve margins are sufficient to maintain reliability in the event of concurrent contingencies but is not the Company's intent to plan for all concurrent contingencies given the low probability of occurrence. A summary of tests in relation to the target is shown below in Table C - 7.

Table C - 7: Islands Energy Reserve Margin Target Stress Test Summary

Energy Reserve Margin Target Stress Test Summary			
Contingency	Oahu (Target 30%)	Hawaii (Target 30%)	Maui (Target 30%)
3x Forced outage rate	Fail	Fail	Fail
2.5x Forced outage rate	N/A	Pass	N/A
2x Forced outage rate	Pass	Pass	Pass
1.5x Forced outage rate	N/A	Pass	N/A
Random Forced Outages	Pass	Pass	Pass
No Demand Response <sup>1</sup>	Pass	N/A	Pass
Reduced Variable Generation <sup>2</sup>	Pass	Pass	Pass
No Load Shifting Storage <sup>3</sup>	Pass	Pass	Pass
50% Storage Forced Outage Rate	N/A	N/A	Pass
20% Storage Forced Outage Rate	Pass	Pass	Pass
10% Storage Forced Outage Rate	Pass	Pass	Pass
Notes: 1. <i>No Demand Response</i> test removed approximately 110 and 20 MW from O'ahu and Maui respectively. 2. <i>Reduced Variable Generation</i> test removed approximately 526, 107, and 160 MW from O'ahu, Hawai'i and Maui respectively. 3. <i>No Load Shifting Storage</i> test removed approximately 140, 60, and 75 MW from O'ahu, Hawai'i and Maui respectively.			





The stress testing indicates that under a range of contingency events, a 30% energy reserve margin is likely sufficient to avoid unserved energy. However, if generating unit outages were three times the historical rate of forced outages, the system may be at risk for unserved energy. Similarly, if any of these contingencies tested occurred at the same time, a 30% energy reserve margin may be insufficient to mitigate reliability risks. In other words, extreme type of events or stacking, cascading events are outside of what the Company normally plans for but the stress testing does provide useful information on the severity of the event that would pass or fail under the criteria as currently defined.

### C.1.9. STAKEHOLDER FEEDBACK

The Company has received feedback from stakeholders as it has developed and discussed its Energy Reserve Margin criteria. That feedback is summarized in bulleted form below and further described in this section.

- Uluono recommended that the Company should adopt a reserve margin tied to reliability analysis.
- Uluono further described a 7-step process to assess the appropriate ERM target. Uluono's recommendations to base the reserve margin on a reliability analysis and to examine incremental ERM targets were incorporated into the ERM analyses described herein.
- The TAP noted ERM is a step in the right direction but cautioned that RESOLVE should not be the only model utilized to arrive at answers and instead should include the broad range of tools discussed in the IGP modeling framework. The Company followed the IGP modeling framework, to develop a resource plan using the RESOLVE capacity expansion model and evaluate the resource adequacy of the resulting plan in the PLEXOS hourly production simulation model, in its ERM analyses.
- Uluono is opposed to the HDC concept and instead recommends adding sample ERM days to the RESOLVE model.
- Telos Energy recommended that ERM can be used in RESOLVE based on their initial resource adequacy analyses, though detailed probabilistic resource adequacy analyses are still needed and further considerations should be made to modify the HDC calculations.
- Telos Energy stated that a robust modeling process should include both deterministic and probabilistic analysis. Deterministic is appropriate for direct input into capacity expansion models like RESOLVE, and probabilistic analysis is used to measure the reliability resulting from a capacity expansion model.

Uluono provided feedback on the Company's first review point,<sup>47</sup> to adopt a reserve margin that is tied to a reliability analysis. Uluono later provided comments on a methodology to

---

<sup>47</sup> Comments of Uluono Initiative LLC on the Hawaiian Electric Companies Updated Integrated Planning Workplan - First Review Point filed on February 25, 2021 in Docket No. 2018-0165.



develop an appropriate reserve margin criteria that were summarized in the TAP's written feedback on the planning criteria.<sup>48</sup> Ulupono further commented on the ERM in their comments on the August I&A Update.<sup>49</sup> A summary of Ulupono's and the TAP's comments as well as the Company's responses are described below.

In their comments on the first review point, Ulupono stated that Hawaiian Electric adopt a reserve margin in later years tied to a reliability analysis and that modeling the worst-weather day in RESOLVE will ensure that the system has a least-cost design that provides enough power at all times.<sup>50</sup>

Ulupono recommends that Hawaiian Electric adopt a reserve margin in later years that is tied to a reliability analysis. Ulupono does not believe it is appropriate to assume that a 30% reserve margin will be needed for the system's load based on the assumption of "poor weather days for renewables." Dr. Fripp notes that poor weather days are already addressed by the requirement that RESOLVE and PLEXOS select resources to keep the power system consistently balanced, including a regulating reserve margin.

Including the worst-weather day in the RESOLVE optimization will ensure that the system has a least-cost design that provides enough power at all times. Consequently, it is not appropriate to apply an ERM as an additional, arbitrary mechanism to achieve generation adequacy. We recommend that Hawaiian Electric eliminate the ERM calculation and margin. Alternatively, if there are reliability factors that are not addressed adequately by the hourly energy and reserve balancing in RESOLVE and PLEXOS, Hawaiian Electric should demonstrate that using analysis and data, and should use a more targeted calculation to achieve reliability.

The Company addressed Ulupono's comments on the first review point in its reply comments.<sup>51</sup> The Company noted its concerns that while the simulation models can perfectly balance unit dispatch to serve load and maintain operating reserves, this diverges from real life where generating units can be suddenly unavailable. The removal of the ERM introduces further risk that will make future renewable plans less reliable and less resistant to climate change.

The Companies note that resource adequacy for high renewable systems is a current topic of discussion in the industry.<sup>52</sup> The Companies view the ERM criteria as something that may evolve over time as it gains operational experience with the new paired solar projects and as more data is acquired and analyzed. The Companies will

---

<sup>48</sup> Grid Services and Planning Criteria Feedback filed on June 1, 2021 in Docket No. 2018-0165.

<sup>49</sup> Comments of Ulupono Initiative LLC on the Hawaiian Electric Companies Updated Revised Inputs and Assumptions filed on September 10, 2021 in Docket No. 2018-0165.

<sup>50</sup> Comments of Ulupono Initiative LLC on the Hawaiian Electric Companies Updated Integrated Planning Workplan - First Review Point filed on February 25, 2021 in Docket No. 2018-0165 at 9.

<sup>51</sup> Hawaiian Electric's Reply Comments filed on March 4, 2021 in Docket No. 2018-0165.

<sup>52</sup> See <https://www.esig.energy/five-principles-of-resource-adequacy-for-modern-power-systems/>



work with the TAP to continue to evaluate this issue and benchmark reliability criteria against other methods being developed in the industry and may make appropriate changes in future IGP cycles.

Simulation models like RESOLVE and PLEXOS assume the system can be perfectly balanced with perfect unit commitment and dispatch of resources to serve load and maintain operating reserves like a mathematical formula with left hand and right hand side variables. However, this solution does not account for sudden changes in the system that can occur in real life where generating units are suddenly unavailable on forced outage or unplanned maintenance is required.

The energy reserve margin also provides a criterion to add new generation to the system, especially as thermal units are retired, and load growth continues. This criterion accounts for the contributions of variable renewables and storage toward meeting reliability and can ensure that reliability needs are met in all hours rather than just at the peak. Without this criterion to help govern the addition of new resources, the profiles and availability of resources on the system will need to be precisely defined and difficult to do through 2050.

Through stakeholder, public meetings, and TAP discussions that reliability of the electrical system is a key outcome and of utmost importance to customers and businesses, and a performance based regulation outcome that our plans need to achieve. The suggestion that a reliability planning criteria like ERM be removed, that poor weather conditions should not be considered as part of reliability criteria, and that balancing constraints and operating reserve defined in RESOLVE and PLEXOS are sufficient to ensure generation adequacy is contrary to the way that almost any other jurisdiction plans for reliability and incongruent with conversations with the TAP. Removing the ERM criteria will make future renewable plans unreliable and less resistant to natural disasters, forty consecutive days of rain, and climate change. The recent events in Texas where extreme weather lead to a shortage of available generation to serve demand and recognizing that the Electric Reliability Council of Texas ("ERCOT") does not have a forward capacity market to procure additional capacity ahead of its delivery day, there is additional risk that must be understood when planning without any forward looking capacity margin.<sup>53</sup>

Uluono provided further comments on a 7-step process to assess the "optimal" ERM. These comments and TAP responses were provided in the TAP's written feedback on the grid services and planning criteria and summarized below.<sup>54</sup> The Company incorporated Uluono's feedback by agreeing to develop a set of analyses that incrementally test different ERM target

---

<sup>53</sup> See <https://www.utilitydive.com/news/the-great-capacity-market-debate-which-model-can-best-handle-the-energy-tr/440657/>

<sup>54</sup> Grid Services and Planning Criteria Feedback filed on June 1, 2021 in Docket No. 2018-0165 at 8.



levels and to develop a sensitivity analysis to examine the effect of using the variable renewable production profiles instead of the HDCs.

Uluono recommends a 7-step process to assess the “optimal” ERM for the system that starts at 0% ERM and increases the ERM percentage until the desired reliability level is reached.

1. Include worst days in time sampling in RESOLVE
2. Count renewables at their full hourly availability in RESOLVE
3. Set initial ERM to 0%
4. Run RESOLVE with current ERM
5. Test the resulting plan with many years of data (e.g., in PLEXOS) – include all possible weather, realistic forecast errors for load and renewables, forced outages for thermal plants and batteries, etc.
6. If shortfalls are found: increase ERM by a few percent and return to step 4
7. Repeat until shortfalls are resolved

Stakeholders felt that in Hawaiian Electric’s approach, ERM may be too conservative and lead to an overbuild of capacity. ERM may also favor thermal units in its derivation because loss of largest unit, multiple forced outages, and unplanned maintenance are implicit thermal unit considerations. Uluono noted that the HDC used to calculate the variable renewable contributions excessively discounts the generation provided by these resources and is not necessary.

At this particular meeting, a TAP member was present and commented that they support transition away from a planning reserve looking at peak to one that assesses hourly load. For reference, Southern California Edison and Community Choice Aggregators have proposed a similar planning criteria to energy reserve margin that examines all hours. Planning reserve margins focused on system peak was based on resource adequacy and loss of load. To meet the reliability criteria, the system needed X% of margin. It would be interesting to link and correlate traditional metrics such as loss of load expectation (“LOLE”) with ERM. A large driver of 30% was driven by multiple unit outages. When considering retirement of fossil units, the risk of concurrent outages diminishes. Another stakeholder liked the idea of linking ERM to LOLE.

The TAP provided further comments on the ERM in their review, noting that “ERM is a step in the right direction” but cautioned that RESOLVE should not be the only model utilized to arrive



at answers and instead should include the broad range of tools discussed in the IGP modeling framework.<sup>55</sup>

TAP agrees that HECO is correct to identify a need to change the conventional planning reserve margin used in previous planning efforts with a new methodology that evaluates all hours of the year and chronological operations of the grid. A reliability criterion that only evaluates peak load is inadequate for a system with high percentage penetrations of variable renewables and energy limited resources (storage and load flexibility). ERM is a step in the right direction. If developed and implemented correctly, it may help reduce or eliminate reliability shortfalls that were present in past portfolios without grid modifications.

The TAP also recognizes that capacity planning models requires some 'relatively simple' methodologies to address the many issues impacting reliability including the various reserve margins, renewable variability, and unit outages in order to efficiently analyze the many options available for capacity expansion. TAP agrees that ERM is a reasonable approach to take. However, there should be clarity on how values are reached and how different grid resources are considered in analyses.

That said, caution should be applied to using only RESOLVE to arrive at answers. However accurately the ERM or other methodology selected is, RESOLVE alone does not provide the fidelity needed to determine and validate a cost effective, reliable expansion plan. A number of comments/suggestions in regard to the use of ERM in RESOLVE to determine reliable least cost design are summarized below.

- ERM is a novel approach that does not have precedence in Hawaii or other jurisdictions. As a result, additional information, analysis, and testing is required to ensure that ERM is used effectively in the HECO planning process. In regard to this, HECO has not, to date, provided sufficient information on the ERM to assess the ERM values currently proposed (30% ERM target on Oahu, Maui, and Hawaii or the 60% targets on Molokai and Lanai). In particular, TAP has requested additional information on the calculation of hourly dependable capacity. Recognizing the value of a metric like ERM for use in capacity expansion models and the need to continue progressing down the IGP pathway, the TAP recommends that a) a more complete description of the determination of the current ERM values be developed and made available for review as soon as possible and b) analysis be conducted to determine the relationship between ERM and detailed resource adequacy analysis. The latter is discussed in more detail below. The TAP agrees that engineering judgment is important when going from reliability planning concepts and models to operational reliability.

---

<sup>55</sup> Grid Services and Planning Criteria Feedback filed on June 1, 2021 in Docket No. 2018-0165 at 10.



- Ulupono states “Including the worst-weather day in the RESOLVE optimization will ensure that the system has a least-cost design that provides enough power at all times. Consequently, it is not appropriate to apply an ERM as an additional, arbitrary mechanism to achieve generation adequacy”. The TAP does not agree with this statement. While selection of a broad range of daily operations and best estimates of reserves might provide a closer estimate for capacity growth, final determination of the cost-effective, reliable path forward requires use of all the tools identified as was discussed in detail in Section 3.
- One member of TAP noted that the current ERM equation is flawed because it does not explicitly address unplanned outage rates of fossil generation. The model incorporates uncertainty for maintenance (planned outages) and variability of the renewable resources, but treats fossil generation as “firm capability.” The 30% ERM is then meant to cover unexpected outages of the fossil fleet and load uncertainty. This method is biased in that it assigns reliability risk to variable renewables, but does not discount fossil generation which is treated as perfect capacity.
- As stated above, there is agreement that a metric for RESOLVE is needed, but it should be allowed to evolve and change as new information and subsequent process steps are run. TAP recommends that a plan be developed to conduct the analysis to determine the relationship between ERM and detailed resource adequacy analysis as discussed below. This may yield a better value for ERM or a process for ERM determination. At a minimum, RESOLVE should be run with various values of ERM and outputs assessed using detailed reliability tools.

Ulupono has suggested a seven-step plan for assessment of the ERM. The TAP is concerned that this plan is wholly focused on RESOLVE for the determination of the final plan. Weaknesses in this methodology have already been discussed.

In response to the Ulupono recommendation, the Company has suggested a portfolio that meets ERM requirements of 10%, 20% and 30% could be evaluated for a single year and compared to a detailed probabilistic resource adequacy assessment across many weather years and generator outage draws. The results of the different ERM portfolios could be quantified with resource adequacy metrics like LOLE, LOLP, LOLH, and EUE to validate various ERM levels to common RA metrics. The TAP generally agrees with this approach with the recommendation that all parties be involved in the design of the scenarios to be used for this analysis.

- As discussed in Section 3, it was noted that at least some mainland utilities utilize LOLP as a hard constraint (i.e., 1 day in 10 years), utilizing daily outage profiles to develop a reserve margin. Hawaiian Electric previously used a 1 day in 4.5 year LOLP metric for Oahu. While TAP thought there may be limitations



to this process for more distributed systems such as those in Hawaii, a more thorough assessment of this process could be included as part of the evaluation of ERM and reliability.

Section 2.2.2 and Appendix K provide additional details of areas agreement in response to Ulupono's suggestions and the TAP's review and recommendations in regards to Ulupono's comments.

In their comments on the August I&A Update, Ulupono provided suggestions to improve the process to develop an ERM target and expressed concerns regarding the use of HDCs to define variable renewable capacity contributions.

In the March 2021 report, Hawaiian Electric proposed an ERM equal to 30% of system load each hour on Oahu, Hawaii and Maui, and 60% of system load on Molokai and Lanai. Hawaiian Electric did not put forward a clear rationale for these levels, and the targets appeared to be based on historical rules of thumb and/or studies based on historical design of the power system. We support Hawaiian Electric's proposal to abandon this approach and instead test several targets, then evaluate the reliability of the proposed plan with each one, and adopt the lowest ERM target that produces adequate reliability. This is a straightforward approach that will avoid the risk of overbuilding based on arbitrary targets.

However, we recommend a few improvements to this process:

- d. It would probably be helpful to include N-1 outage criteria in RESOLVE itself, so the model can optimize the selection of large vs. small power plants.
- e. The September 7, 2021 proposal uses 10% steps in the ERM. Once the modeling is underway, it would be useful to evaluate finer steps between the maximum inadequate ERM and the minimum adequate ERM, to more closely identify the correct level.
- f. Hawaiian Electric reported in the September 7, 2021, meeting that they do not plan to include demand response in the ERM calculation. We recommend that demand response (and all other resources) be included in the ERM calculation in the same way that they are included in the day-to-day load balancing (more on this below).

Within the ERM framework, we are opposed to Hawaiian Electric's earlier proposal to calculate HDC factors for each resource. The HDC framework is an outdated approach that is not suitable for power systems with large shares of renewable power, storage and demand-side flexibility. The HDC approach attempts to assign a fixed "capacity" value to each resource, when in fact generation adequacy arises from the full portfolio of resources and cannot be reflected by a single "capacity" metric. The contribution of an additional solar project to generation adequacy varies depending on how much other solar, wind, storage or demand response is implemented at the same time. It is simply not possible to assign a meaningful HDC to each resource. A key strength of





Switch, RESOLVE or other models in this family is that they consider the full time-series of production or behavior available from each resource, and select a portfolio that will provide a reliable supply of power under all conditions. HDC does not aid in this analysis, and instead biases the model in favor of traditional, "firm" assets.

Put another way, the contribution of each resource to generation adequacy each hour is simply the amount of power that it is able to produce in that hour. So the capacity counted toward the ERM requirements during each sample hour should be equal to the production potential during that hour, as already represented in RESOLVE. The HDC approach replaces the useful information on time-varying availability of each resource with a constant, arbitrary value based on statistical analysis of the resource. This understates the usefulness of each resource at the times when it is actually available (e.g., solar on sunny days) and overstates its usefulness at times when it is not available (e.g., solar on cloudy days).

Ulupono is also opposed to the method that Hawaiian Electric proposed for calculating HDC. In the March 2021 Report, Hawaiian Electric proposed to use the mean production from each resource, minus N standard deviations of the hourly production. If output from the resource followed a Gaussian distribution, then using N=3 would produce an estimate of the 99.7% reliable output. However, wind and solar output do not follow a Gaussian distribution, so this method would not actually identify the expected percentile of output. Further, the 99.7% reliable output from a solar array or wind farm is not a useful statistic for capacity planning, as discussed in the previous paragraphs.

Instead of using the HDC approach, we recommend that the ERM be modeled in RESOLVE by adding a collection of "ERM" sample days with higher than normal loads, which the model is free to serve using all resources at its disposal. Specifically, RESOLVE should include a collection of normal sample days that reflect the full range of weather that may be experienced (this can include normal days as well as the most difficult weather day or days that the islands have experienced, with appropriate weights; this should be similar to the current sampling method for RESOLVE). Then one or more "ERM" sample days should be added, with low or 0% chance of occurring. (For days assigned a 0% probability, RESOLVE must select a plan that could serve loads on those days, but it does not work hard to minimize fuel costs on those days because they have negligible likelihood of occurring. A 0% probability is appropriate for these days because they are not expected to actually occur; they are just used to drive the system to build extra capacity.) On the ERM days, loads should be equal to the normal level on a corresponding historical date plus the ERM percentage (one simple approach would be to create ERM days that are based directly on the standard sample days, but with higher loads). When RESOLVE is run in this way, it will need to select a portfolio that can meet loads on both the standard and ERM days. However, it is free to apply all available resources to the ERM target, including renewables, storage, demand-response and thermal plants. This approach will force RESOLVE to design a power





system that *could* meet the extra-high loads on ERM days, but which is also optimized primarily for the conditions on the standard sample days. In this way, the ERM calculations will choose the cheapest portfolio of resources to meet normal loads, while also including additional capacity to improve generation adequacy.

The Company provided its response to Ulupono's comments on the August Update in its reply comments, noting that defining adequate reliability could require a high degree of engineering judgement<sup>56</sup> and that the Company will consult the TAP once it has completed its ERM analysis. The Company continued to assert that HDCs are appropriate to characterize the reliable capacity from variable renewable resources as historical weather days may not be fully representative of all possible weather in the future. As mentioned previously by the TAP, the Company reiterated that the RESOLVE model by itself may not be appropriate to consider the full hourly time series and that reliability analyses are better suited for PLEXOS, consistent with the modeling framework that was agreed to with the TAP.

Regarding Ulupono's suggestion regarding the inclusion of N-1 outage criteria, the Company does impose single point of failure requirements for system security reasons i.e., 135 MW for O'ahu, 20 MW for Maui, and 30 MW for Hawai'i Island. This helps to limit the impact of large units adversely impacting reliability. These limits are balanced with increased cost as smaller size limitations may increase costs for interconnection and reduce economies of scale.

The Company also clarifies that demand response programs are currently being modeled as a supply side resource so they are taken into account as part of the ERM modeling in RESOLVE.

Regarding Ulupono's comments regarding elimination of HDCs, the Company believes that HDCs are appropriate to characterize the reliable capacity from variable renewable resources for long-term capacity expansion modeling. The HDC can serve as a reasonable assessment of reliable variable renewable capacity because the most difficult historical weather days may not represent the renewable energy generating potential on the most difficult weather days in the future and can help to ensure adequate capacity is available to serve load because all possible weather would be difficult to explicitly model. As noted above, the TAP did not agree with this suggestion.

---

<sup>56</sup> The TAP in its June 1, 2021 Grid Services and Planning Criteria Feedback at pages 5-6:

Several times was emphasized by TAP that reliability is critical and "when we think about reliability, we do not want to be short." This may require prioritizing the near-term over the long-term - because in the near-term we're not able to change things as much. There is a need to think about this issue as "minimums," that are required and then looking at the costs of the alternatives for meeting the minimums. Utilities don't want to get caught short on reliability. While the TAP agreed that there can be advantages to going long and growing into it, it was also pointed out that the frame for utilization of these resources must be carefully considered. This is another area, requiring 'engineering judgement', not just models. (emphasis added)



Ulupono's comments on this topic are focused on the evaluation of all aspects of long-term planning (i.e., resource addition optimizations, reliability, operations, etc.) within a single model like RESOLVE or SWITCH. RESOLVE and similar models do not consider the full time series of resource production due to the model's convention to model representative days that are then weighted to extrapolate to full years.

The Company notes that Ulupono's concerns should be addressed through hourly production simulation model like PLEXOS that can consider each hour of each year of the planning horizon. As discussed at the June 4 Technical Conference and in this report, as part of the modeling framework that was recommended by the TAP in its June 1, 2021 Grid Services and Planning Criteria Feedback at pages 3-6, the modeling framework has a specific Resource Adequacy step that can assess reliability without the use of HDCs and instead use stochastic analysis on actual production profiles.

Further, in response to TAP feedback to correlate ERM to LOLE and to utilize PLEXOS to assess resource adequacy, Telos Energy conducted an independent reliability assessment<sup>57</sup> for O'ahu and Maui. In their preliminary results for Maui and O'ahu using a stochastic analysis to derive LOLE on the RESOLVE developed capacity expansion plans at different ERM targets, Telos Energy stated, "Based on initial test cases, a 30% ERM proposed by HECO shows a reasonable level of reliability – for the current resource mix – when evaluated with more detailed probabilistic assessment."

In the October 13, 2021 STWG meeting, stakeholders noted it would be helpful to further understand the impact of HDCs on the resulting resource plans and requested the Company evaluate a resource plan using a one sigma PV HDC and evaluate a separate resource plan using the production profiles for variable renewables while still assuming thermal resources are not available as candidate options. The Company conducted a supplemental analysis in RESOLVE to determine the impact of these assumptions on the resource plan. The results of the supplemental analyses are described in Section .0.o.o.

Telos provided additional comments and recommendations as part of their presentation to the TAP Resource Adequacy Subgroup on November 1, 2021.<sup>58</sup> Telos requested that the justification for the 30% ERM should be provided (see, Section 2.2.3.1, above) and further evaluation of ERM at higher levels of variable renewable energy is warranted. While they

---

<sup>57</sup> See ERM Calibration and Resource Adequacy presented by Telos Energy on October 13, 2021 to the Stakeholder Technical Working Group at [https://www.hawaiianelectric.com/documents/clean\\_energy\\_hawaii/integrated\\_grid\\_planning/20211013\\_hnei\\_erm\\_stakeholder\\_presentation.pdf](https://www.hawaiianelectric.com/documents/clean_energy_hawaii/integrated_grid_planning/20211013_hnei_erm_stakeholder_presentation.pdf). Telos Energy included updates for next steps and recommendations for the ERM criteria in their presentation on November 1, 2021 to the Technical Advisory Panel at [https://www.hawaiianelectric.com/documents/clean\\_energy\\_hawaii/integrated\\_grid\\_planning/stakeholder\\_engagement/technical\\_advisory\\_panel/20211101\\_tap\\_hnei\\_grid\\_integration\\_erm\\_calibration.pdf](https://www.hawaiianelectric.com/documents/clean_energy_hawaii/integrated_grid_planning/stakeholder_engagement/technical_advisory_panel/20211101_tap_hnei_grid_integration_erm_calibration.pdf).

<sup>58</sup> See [https://www.hawaiianelectric.com/documents/clean\\_energy\\_hawaii/integrated\\_grid\\_planning/stakeholder\\_engagement/technical\\_advisory\\_panel/20211101\\_tap\\_hnei\\_grid\\_integration\\_erm\\_calibration.pdf](https://www.hawaiianelectric.com/documents/clean_energy_hawaii/integrated_grid_planning/stakeholder_engagement/technical_advisory_panel/20211101_tap_hnei_grid_integration_erm_calibration.pdf)



recommended that an ERM can be used in RESOLVE, a resource adequacy back-check is still needed and HDC calculations should be considered further.

On the HDCs, Telos noted,

- Wind vs. solar should both have the same 1 sigma from mean to avoid perception of discrimination
- Consider aggregating like-hour data across a month rather than a 3-day rolling average, currently being used by the Companies for HDC calculations
- Use long-term dataset of simulated weather conditions, rather than recent historical output
- Review California's exceedance methodology and compare to HDC method
- Calculate HDC for the portfolio of VRE (or by resource) rather than individual projects

### C.1.10. ERM ANALYSIS

The ERM criteria is composed of two key assumptions: a target percent reserves to cover various contingencies and an hourly dependable capacity (HDC) to account for the impact of weather variability on renewable generation output. For each island, the ERM target percentage was incremented at regular intervals to assess the incremental impact to the resource build. Additional cases were run to test the sensitivity of the HDC to different available candidate resources and varying levels of capacity value for variable renewable production.

#### C.1.10.1. Assumptions

##### Target ERM Percentage

For O'ahu, Hawai'i Island, and Maui, intervals of 10% were assumed from 0% to 40%. For Moloka'i and Lāna'i, intervals of 20% were assumed from 0% to 60%.

##### Candidate Resources

RESOLVE was able to build PV, onshore and offshore wind, battery energy storage systems (BESS), PV paired with BESS, internal combustion engines (ICE), combustion turbines, combined cycle units, biomass, and geothermal (on Hawai'i Island only) as replacement capacity.

##### Unit Removals



As a starting point, all generating unit removals assumed by 2030 in the August 2021 Inputs and Assumptions were included. At lower ERM targets, additional unit removals were assumed based on initial testing in RESOLVE to determine the total firm capacity that would be installed if all existing thermal generating units were removed. This was to prevent the resource plan from significantly exceeding the ERM targets, particularly at lower percentages, due to the contributions of existing resources.

### Maintenance

For O‘ahu, Hawai‘i Island, and Maui, representative planned maintenance was assumed in 2030 for the existing thermal units and future thermal units selected by RESOLVE. For Moloka‘i and Lāna‘i, a planned outage of one 2.2 MW ICE was included.

After developing the initial analyses which were shared with the Stakeholder Technical Working Group on October 13, 2021 and Technical Advisory Panel on November 1, 2021, the Company ran additional cases in PLEXOS to test the sensitivity of the maintenance on the resulting reliability of the resource plans at the different ERM target levels. The assumption for planned and unplanned maintenance was revised to be a general maintenance outage that could be scheduled by PLEXOS. This was done probabilistically where 15 different sets of forced outages or “loops” were simulated.

### Hourly Dependable Capacity

An hourly dependable capacity was assumed for variable renewable resources. A comparison of the HDC (discounted by 1 and 2 sigma) to its production profiles for O‘ahu PV and wind is provided below.

The HDCs are designed to mitigate uncertainty risk in its capacity credit for variable renewables because there is uncertainty in future variable renewable production due to several factors. Grid-scale PV projects have only come online in the last few years so there is not a long, developed record of historical production to build confidence in what these projects could reliably produce over the 30 year planning horizon. Similarly, large hybrid solar and storage plants are expected to come online in the next few years and are an entirely new resource to operate on the grid. After the Company gains experience managing the operations of this type of resource, the HDCs can be modified if the expected capacity value and performance are different than what was initially assumed. Further, while the historical production of existing projects provides a basis for initial hourly dependable capacity assumptions, there are no guarantees that future renewable production will be similar, especially over the longer term of the 30 year planning horizon, recognizing that climate change could have an impact on production of variable renewable resources in the future.



Figure C- 1: O’ahu Utility Solar Hourly Potential Energy Profiles

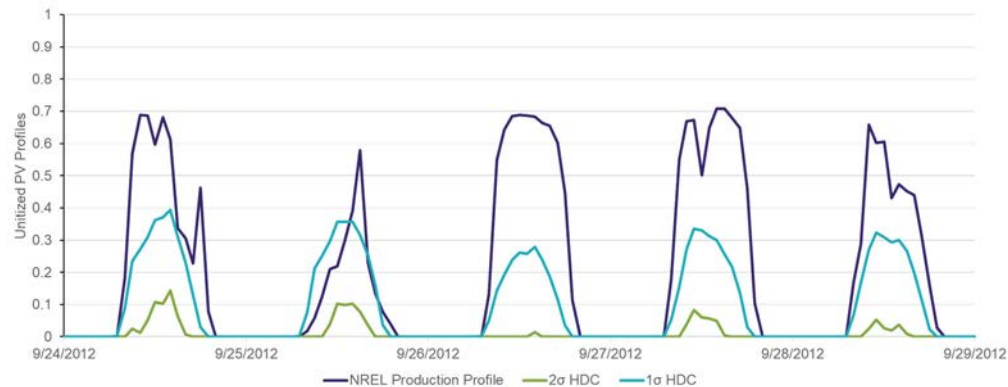
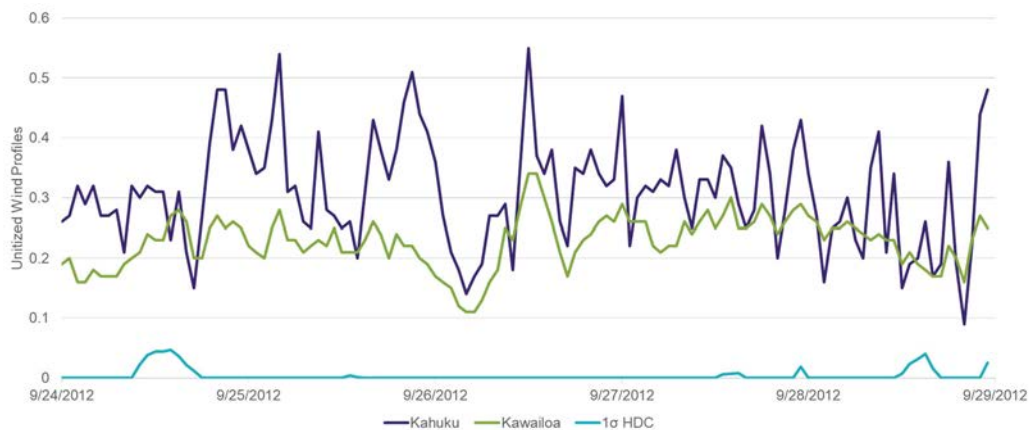


Figure C- 2: O’ahu Wind Hourly Potential Energy Profiles



Model Horizon

The resource plans were developed specifically for year 2030 to better discern resources added for capacity rather than energy.

Demand Forecasts

The resource plans were developed and evaluated using the IGP sales forecasts provided in the August I&A Update.<sup>59</sup>

The Companies’ demand forecasts are derived by combining monthly energy forecasts and hourly load profile forecasts. The forecasts are driven by the economy, weather, electricity price, known adjustments to large customer loads, and impacts of energy efficiency (EE), distributed energy resources (DER), primarily photovoltaic systems with and without storage (i.e., batteries), and electrification of transportation (light duty electric vehicles (EV) and

<sup>59</sup> See [https://www.hawaiielectric.com/documents/clean\\_energy\\_hawaii/integrated\\_grid\\_planning/stakeholder\\_engagement/working\\_groups/forecast\\_assumptions/20210818\\_finaligp\\_inputs\\_and\\_assumptions.pdf](https://www.hawaiielectric.com/documents/clean_energy_hawaii/integrated_grid_planning/stakeholder_engagement/working_groups/forecast_assumptions/20210818_finaligp_inputs_and_assumptions.pdf)



electric buses (eBus), collectively “EoT”). The forecasts assume 20-year average (1999-2018) weather with an added warming trend of 1.5 degrees F over the 20-year average by 2050.

Daily weather inputs for the hourly shape forecasts are rank-and-average by month. The rank-and-average daily weather series are derived via the following steps:

1. Historical daily weather for each month and year is ranked from highest to lowest.
2. The average of each rank across all historical years was calculated. For example, temperature data results in an average hottest day, average second hottest day, average third hottest day, etc. for each month.
3. For temperature inputs (including temperature, cooling degree days, and temperature-humidity index), the resulting temperature data is adjusted upward to reflect the warming trend.
4. The daily weather in each month is re-ordered from the highest to lowest ranking to a pattern that follows a daily weather pattern from a prior historical year.

### C.1.10.2. Process

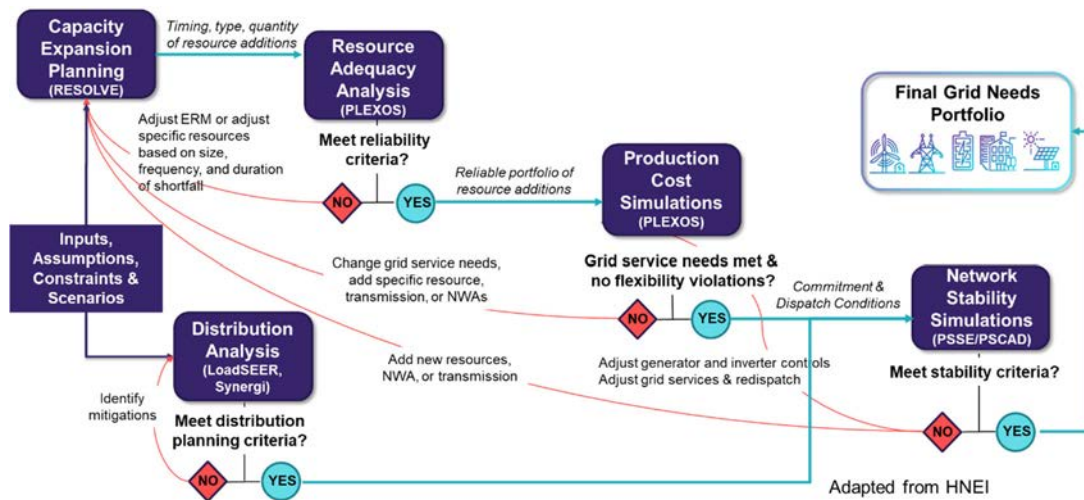
The IGP modeling framework provides a process to evaluate resource plans. Because ERM is a planning input that determines resource buildout for capacity expansion planning and that same buildout of resources determine resource adequacy toward meeting capacity planning criteria, the first two steps of the framework were utilized in this analysis to test ERM. The RESOLVE model was utilized for the capacity expansion planning step and the PLEXOS model for the resource adequacy step. Both models were updated to the August 2021 Inputs and Assumptions in the IGP docket.<sup>60</sup>

---

<sup>60</sup> See Inputs and Assumptions, <https://www.hawaiielectric.com/clean-energy-hawaii/integrated-grid-planning/stakeholder-engagement/key-stakeholder-documents>



Figure C- 3: IGP Modeling Framework



RESOLVE was run to solve for various changes in ERM target percentage and HDCs to examine its effect on the resulting resource build in year 2030. PLEXOS was run to assess the ERM and related metrics of the resource build developed in RESOLVE for year 2030. The 2030 plan included planned Stage 1 and 2, demand response, and existing renewables. All generating unit removal assumptions by 2030 proposed in August I&A Update were included as a starting point. For the purposes of ERM testing, HNEI suggested taking out future resources selected by RESOLVE for economic reasons (and not for capacity) e.g. wind or solar.

Using the 30% ERM target for O’ahu, Hawai’i Island, Maui and 60% ERM target for Lāna’i, Moloka’i, additional cases were developed for further evaluation. These cases test the use of regular production profiles instead of the HDCs, use of HDCs for PV defined as mean minus 1 sigma (instead of minus 2 sigma), and removal of all thermal units (ICE, CT, CC, biomass, geothermal) as candidate options for RESOLVE to select (only wind, solar, and storage were allowed to be built to meet capacity needs). This allows for a better understanding of how the RESOLVE model is using the ERM target and HDC to select resources to meet ERM criteria. During the actual Grid Needs Assessment, all resources selected by RESOLVE will be evaluated in the Resource Adequacy step to determine whether there is a shortfall or surplus of capacity.

Utilizing the resource plans developed in RESOLVE, PLEXOS was run to assess the reliability of the plans to 1) meet the load increased by the ERM in an ERM test and to 2) meet load without any margin in a production simulation. To evaluate whether the resource plans would meet the load increased by the ERM in the ERM test, PLEXOS was run with no forced outages (because these are accounted for in the margin), with HDCs applied for the variable renewables production, and with the system load increased by the corresponding ERM target i.e. the 30% ERM case increased load by 30%. Separately, the PLEXOS was also run to assess whether the resource plan could serve load without any margin under typical production simulation conditions where forced outages of thermal units were accounted for through a random outage sampling using the Monte Carlo method, the full production profiles for variable





renewables was assumed, and the load forecast was assumed without additional margin. This method would provide insight into Ulupono's concern regarding the use of HDCs.

### C.1.10.3. Results

Summary tables of the PLEXOS analyses to evaluate the RESOLVE resource plans are provided below.

Generally, the results of the analyses show that:

- There can be violations of the ERM target in an ERM test (i.e., load + margin) that do not lead to unserved energy in a production simulation to serve load without any margin.
- Higher ERM targets produce plans in RESOLVE that can reasonably serve the load without any unserved hours or energy but may have violations in meeting the load with ERM when evaluated in hourly simulations in PLEXOS.
- Lower ERM targets produce plans in RESOLVE that cannot serve the load with or without the ERM when evaluated in hourly simulations in PLEXOS.
- Assuming additional capacity value for the variable renewables by swapping the HDCs for the full production profile reduces the buildout of resources for capacity in RESOLVE. However, the resulting resource plan will have difficulty meeting the load with or without the ERM in hourly simulations in PLEXOS.
- When thermal units are not allowed as a candidate resource, the resource plan will build much larger amounts of paired variable renewables and storage.

## O'ahu

Table C - 8 shows the resource plans based on the RESOLVE modeling for the seven different cases that were modeled. Each case assumes the ERM target indicated and an HDC using the 2 sigma profiles for PV, 1 sigma profiles for wind, except the Production Profile case where production profiles were applied in lieu of an HDC. The Remove Thermal Candidates case does not allow thermal generation to be built by the model to test how ERM is met through other resource technologies.





Table C – 8: RESOLVE Capacity Expansion Plans for O’ahu

Island (MW)	0% ERM	10% ERM	20% ERM	30% ERM	40% ERM	Production Profile (30% ERM)	Remove Thermal Candidates (30% ERM)
Existing Thermal Capacity	1,542	1,542	1,542	1,542	1,542	1,542	1,542
Thermal Capacity Removed (-)	-636	-536	-450	-367	-367	-367	-367
Remaining Thermal Capacity	906	1,006	1,092	1,175	1,175	1,175	1,175
Planned DR Capacity	88	88	88	88	88	88	88
Planned PV Capacity	398	398	398	398	398	398	398
Planned Wind Capacity	123	123	123	123	123	123	123
Planned PV+BESS Capacity	372	372	372	372	372	372	372
Planned BESS Capacity	185	185	185	185	185	185	185
New Thermal Capacity (+)	0	0	0	57	171	0	0
New BESS Capacity (+)	316 MW 594 MWh	316 MW 594 MWh	316 MW 594 MWh	308 MW 579 MWh	283 MW 532 MWh	316 MW 594 MWh	344 MW 667 MWh
New PV+BESS Capacity (+)							399 MW 6-hr PV+BESS
New Variable Renewables (+)	771	771	771	760	732	771	648

In resource plans where thermal candidate resources were not allowed to be built, RESOLVE selected 399 MW of PV paired with 6-hour BESS at a 30% ERM. In the base 30% ERM case, RESOLVE selected 57 MW of thermal capacity which provides a rough equivalent of 57 MW firm capacity to 399 MW of PV paired with 6-hour BESS. In the resource plans that include a 30% ERM target and production profiles for variable renewables (no HDCs assumed), the 57 MW of thermal capacity was not built.

Table C - 9 through Table C - 11 show the results of the RESOLVE cases shown above evaluated in PLEXOS. The purpose of these runs was to evaluate whether RESOLVE is building (under or over) the capacity needed to satisfy the ERM target, and whether there was unserved energy when evaluating each hour of the year. In PLEXOS, different HDC levels were tested (2 sigma, 1 sigma, and using production profiles in lieu of HDC). The PLEXOS model was run to dispatch units to explicitly meet the ERM target i.e. load plus margin.

Table C – 9: PLEXOS 2 Standard Deviation PV HDC ERM Test on RESOLVE O’ahu Plans

2 Std Dev PV HDC	0% ERM	10% ERM	20% ERM	30% ERM	40% ERM	Production Profile (30% ERM)	Remove Thermal Candidates (30% ERM)
Pass / Fail	FAIL	FAIL	FAIL	FAIL	FAIL	FAIL	FAIL
Estimated ERM Level (%)	-16%	-6%	4%	18%	30%	12%	12%
Max Hourly Shortfall (MW)	431	273	463	314	421	470	490
Max Daily Unserved Energy (MWh)	3,590	3,220	3,589	2,302	1,733	4,182	3,633
Annual Unserved Energy (MWh)	97,478	103,441	129,827	44,712	21,136	148,968	92,235
Annual Unserved Hours (Hrs)	847	964	1118	493	260	1206	737



Table C - 10: PLEXOS 1 Standard Deviation PV HDC ERM Test on RESOLVE O’ahu Plans

1 Std Dev PV HDC	0% ERM	10% ERM	20% ERM	30% ERM	40% ERM	Production Profile (30% ERM)	Remove Thermal Candidates (30% ERM)
Pass / Fail	FAIL	FAIL	FAIL	FAIL	FAIL	FAIL	FAIL
Estimated ERM Level (%)	-10%	0%	10%	26%	38%	20%	24%
Max Hourly Shortfall (MW)	318	242	272	286	367	333	182
Max Daily Unserved Energy (MWh)	2,183	1,511	1,745	1,061	539	2,130	630
Annual Unserved Energy (MWh)	27,476	29,313	43,759	6,839	1,386	50,542	2,797
Annual Unserved Hours (Hrs)	314	332	476	124	31	515	43

Table C - 11: PLEXOS ERM Test without HDCs on RESOLVE O’ahu Plans

No HDC	0% ERM	10% ERM	20% ERM	30% ERM	40% ERM	Production Profile (30% ERM)	Remove Thermal Candidates (30% ERM)
Pass / Fail	FAIL	FAIL	FAIL	PASS	PASS	FAIL	PASS
Estimated ERM Level (%)	-4%	8%	14%	30%	42%	24%	42%
Max Hourly Shortfall (MW)	91	114	161	0	0	163	0
Max Daily Unserved Energy (MWh)	213	129	766	0	0	733	0
Annual Unserved Energy (MWh)	753	583	4,441	0	0	5,974	0
Annual Unserved Hours (Hrs)	28	25	105	0	0	144	0

In response to stakeholder comments at the October 13, 2021 STWG meeting to evaluate a resource plan using a one sigma PV HDC and evaluate a separate resource plan using the production profiles for variable renewables while still assuming thermal resources are not available as candidate options, the Company conducted a supplemental analysis in RESOLVE to determine the impact of these assumptions on the resource plan. The results of the supplemental analysis are provided in Table C - 12.

Table C - 12: Supplemental RESOLVE Capacity Expansion Plans for O’ahu

Island (MW)	1 Std Dev PV HDC (30% ERM)	Remove Thermal Candidates, Production Profile (30% ERM)
Existing Thermal Capacity	1,542	1,542
Thermal Capacity Removed (-)	-367	-367
Remaining Thermal Capacity	1,175	1,175
Planned DR Capacity	88	88
Planned PV Capacity	398	398
Planned Wind Capacity	123	123
Planned PV+BESS Capacity	372	372
Planned BESS Capacity	185	185
New Thermal Capacity (+)	0	0
New BESS Capacity (+)	312 MW 602 MWh	312 MW 602 MWh
New PV+BESS Capacity (+)		
New Variable Renewables (+)	771	771

The resulting plans for these two cases were very similar to the Production Profile case already run so it is reasonable to assume that the ERM Test and Stochastic Outage Production



Simulation in PLEXOS would also have similar results. In comparing the Remove Thermal Candidates case that was already run assuming HDCs to the Remove Thermal Candidate case using the production profiles in the supplemental analysis, the 399 MW of PV paired with 6-hour storage was no longer built. This is due to the additional capacity value provided to the PV resources when assuming their production profiles in RESOLVE. Further, the Production Profile case and one standard deviation PV HDC case did not have large differences in resource buildout because the one standard deviation value for the PV HDC provided a significant portion of the capacity value that is provided when assuming the production profiles.

Figure C- 4: Effective ERM for O’ahu Cases Using Different HDCs

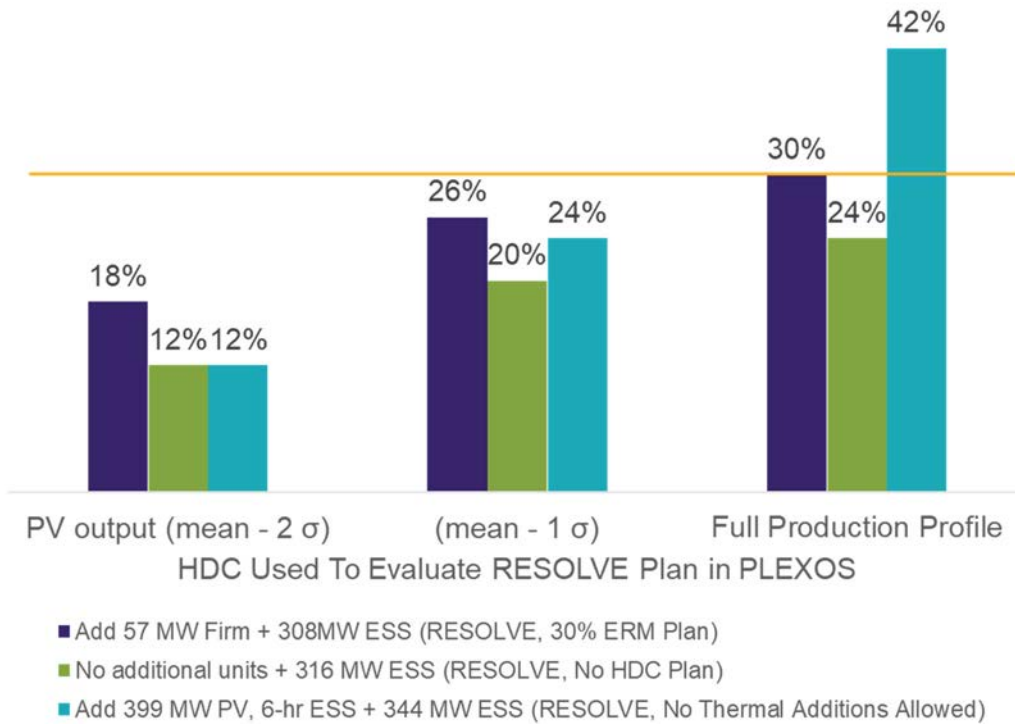


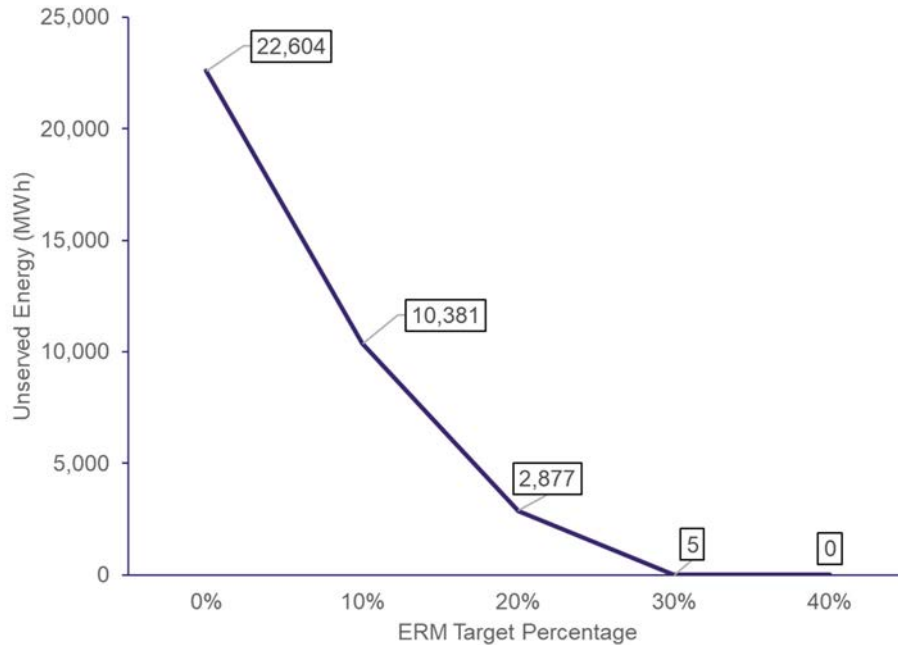
Figure C- 4 shows a comparison of three different plans that RESOLVE built using the 30% ERM target and the results of PLEXOS ERM tests is shown above. The first plan was built using HDCs (purple column), the second plan was built using full production profiles for wind and solar (green column) and the third plan did not allow for new firm generation to be built (aqua column). ERM testing using 1 standard deviation, 2 standard deviation and full production profiles show the effect of using different HDC values on the ERM test results for each RESOLVE plan. Using 1 and 2 standard deviation HDC can help mitigate the risk that poor weather days can have on PV production.



Table C - 13: PLEXOS Stochastic Outage Production Simulation with RESOLVE Oahu Plans

Production Simulation with 15 Outage Loops	0% ERM	10% ERM	20% ERM	30% ERM	40% ERM	Production Profile (30% ERM)	Remove Thermal Candidates (30% ERM)
Annual Unserved Energy (MWh)	22,604	10,381	2,877	4.8	0	153.8	0
Annual Unserved Hours (Hrs)	191.7	84.9	21.9	0.1333	0	2.1333	0

Figure C- 5: O’ahu Unserved Energy by ERM Percentage for PLEXOS Stochastic Outage Production Simulation



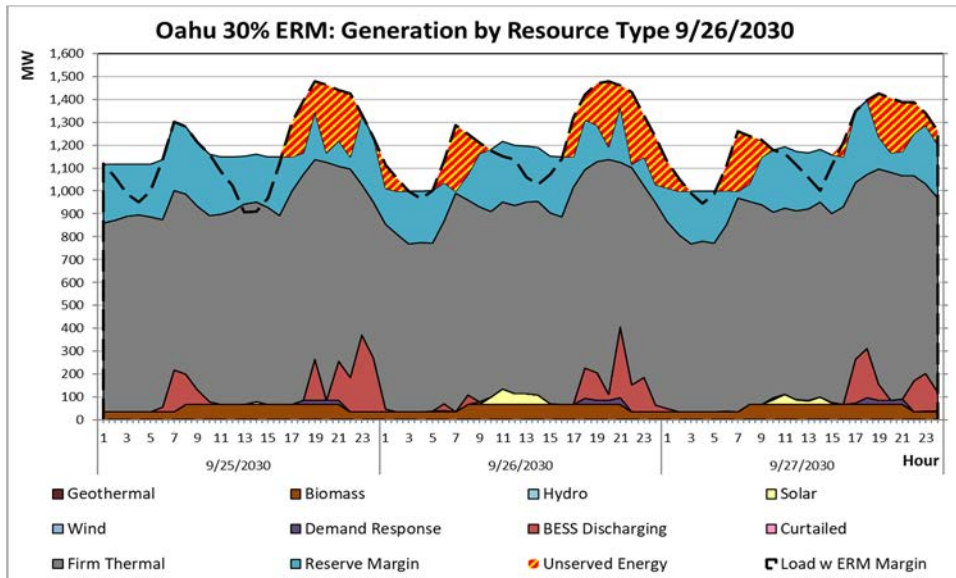
For O’ahu, the ERM tests in PLEXOS showed that the resource plans did not meet the target ERM that was input into RESOLVE. Using one sigma standard deviations for the HDCs reduced the difference between the effective and target ERM but the 30% ERM target was still not met. However, when the resource plans were evaluated as a production simulation in PLEXOS, shown in Table C - 13 and Figure C- 5, unserved energy was significantly reduced at 30% and 40% ERM which supports the reasonableness of a 30% ERM. In addition to the ERM target cases, the plan developed using the production profiles instead of HDCs was not able to serve load in all hours although the plan developed assuming no thermal resource candidates was able to, after building a significant amount of PV+BESS capacity with a longer duration storage. This demonstrates the flexibility of the ERM criteria to evaluate different resource options as the portfolio mix is expected to change over time.

Furthermore, this addresses Ulupono’s concerns that ERM and HDC should not be used in RESOLVE. Applying ERM and HDC ensures that sufficient capacity is built when reliability is evaluated using production profiles, along with planned and unplanned outages in an hourly production simulation.



The daily charts below provide a deeper dive into the results of the ERM Test and Stochastic Outage Production Simulation. Using the 30% ERM target case, the ERM Test indicated that the Energy Reserve Margin was violated in several hours, noted by the red-yellow hashed areas, when the available resources needed to serve the load plus 30% margin and variable renewable resources were limited by their HDCs.

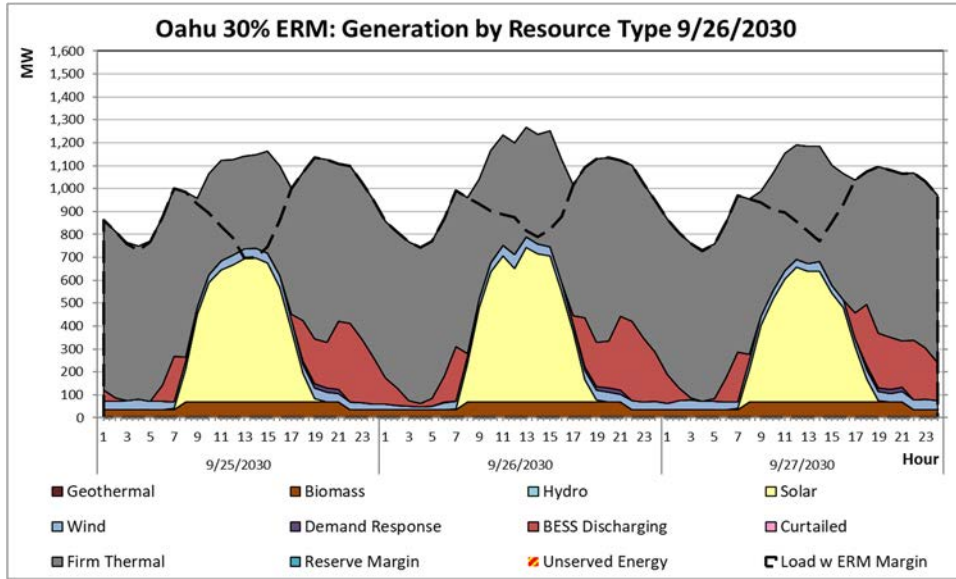
Figure C- 6: O’ahu ERM Test Daily Chart



However, in the Stochastic Outage Production Simulation, no unserved energy was observed on the same set of days as the ERM Test when only serving forecasted load but including forced outages of thermal units and full production profiles of the variable renewables as the HDCs and ERM ensured that sufficient capacity was made available during the development of the resource plan.



Figure C- 7: O’ahu Stochastic Outage Production Simulation Daily Chart



### Hawai‘i Island

Table C - 14 shows the resource plans based on the RESOLVE modeling for the seven different cases that were modeled. Each case assumes the ERM target indicated and an HDC using the 2 sigma profiles for PV, 1 sigma profiles for wind, except the Production Profile case where production profiles were applied in lieu of an HDC. The Remove Thermal Candidates case does not allow thermal generation to be built by the model to test how ERM is met through other resource technologies.

Table C - 14: RESOLVE Capacity Expansion Plans for Hawai‘i Island

Island (MW)	0% ERM	10% ERM	20% ERM	30% ERM	40% ERM	Production Profile (30% ERM)	Remove Thermal Candidates (30% ERM)
Existing Thermal Capacity	282	282	282	282	282	282	282
Thermal Capacity Removed (-)	-155	-141	-127	-112	-112	-127	-112
Remaining Thermal Capacity	127	141	155	170	170	155	170
Planned DR Capacity	0	0	0	0	0	0	0
Planned PV Capacity	9	9	9	9	9	9	9
Planned Wind Capacity	0	0	0	0	0	0	0
Planned PV+BESS Capacity	145	145	145	145	145	145	145
New Thermal Capacity (+)	0	0	0	0	16	0	0
New BESS Capacity (+)	14 MW 26 MWh	14 MW 26 MWh	14 MW 26 MWh	14 MW 26 MWh	14 MW 26 MWh	14 MW 26 MWh	14MW 28 MWh
New PV+BESS Capacity (+)	0	0	0	0	0	0	59 MW, 2hr 35 MW, 4hr
New Variable Renewables (+)	0	0	0	0	0	0	0





In resource plans where thermal candidate resources were not allowed to be built, RESOLVE selected 59 MW of PV paired with 2-hour BESS and 35 MW of PV paired with 4-hour BESS at a 30% ERM. In the base 30% ERM case, RESOLVE did not select any thermal capacity. In the resource plans that include a 30% ERM target and production profiles for variable renewables (no HDCs assumed), no thermal capacity nor paired PV with storage was built.

Table C - 15 and Table C - 16 show the results of the RESOLVE cases shown above evaluated in PLEXOS. The purpose of these runs was to evaluate whether RESOLVE is building (under or over) the capacity needed to satisfy the ERM target, and whether there was unserved energy when evaluating each hour of the year. The PLEXOS model was run to dispatch units to explicitly meet the ERM target i.e. load plus margin.

Table C - 15: PLEXOS ERM Test on RESOLVE Hawai'i Island Plans

ERM Cases	0% ERM	10% ERM	20% ERM	30% ERM	40% ERM
Pass / Fail	FAIL	FAIL	FAIL	FAIL	FAIL
Estimated ERM Level (%)	<-15%	-10%	2%	12%	26%
Max Hourly Shortfall (MW)	24.8	19.3	20.6	18.2	13.5
Max Daily Unserved Energy (MWh)	5,972	4,649	4,964	4,379	3,246
Annual Unserved Energy (MWh)	6,773	5,423	3,920	3,759	1,982
Annual Unserved Hours (Hrs)	324	274	215	218	115

Table C - 16: PLEXOS Stochastic Outage Production Simulation on RESOLVE Hawai'i Island Plans

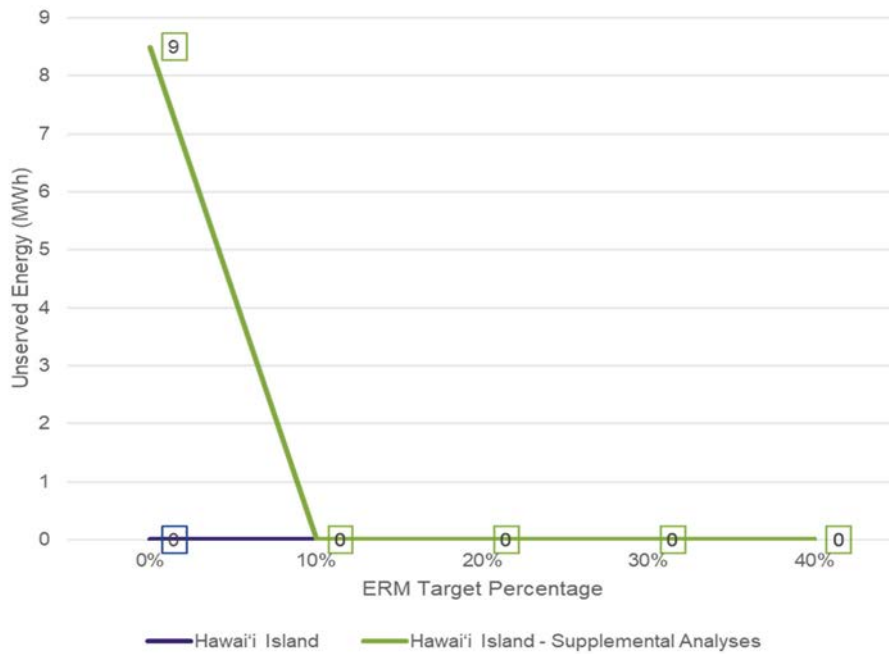
Production Simulation with 15 Outage Loops	0% ERM	10% ERM	20% ERM	30% ERM	40% ERM	Production Profile (30% ERM)	Remove Thermal Candidates (30% ERM)
Annual Unserved Energy (MWh)	0	0	0	0	0	0	0
Annual Unserved Hours (Hrs)	0	0	0	0	0	0	0

Table C - 17: Supplemental PLEXOS Stochastic Outage Production Simulation on RESOLVE Hawai'i Island Plans

Production Simulation with 15 Outage Loops	0% ERM	10% ERM	20% ERM	30% ERM	40% ERM	Production Profile (30% ERM)	Remove Thermal Candidates (30% ERM)
Annual Unserved Energy (MWh)	8.5	0	0	0	0	0	0
Annual Unserved Hours (Hrs)	0.67	0	0	0	0	0	0



Figure C- 8: Hawai'i Island Unserved Energy by ERM Percentage for PLEXOS Stochastic Outage Production Simulation



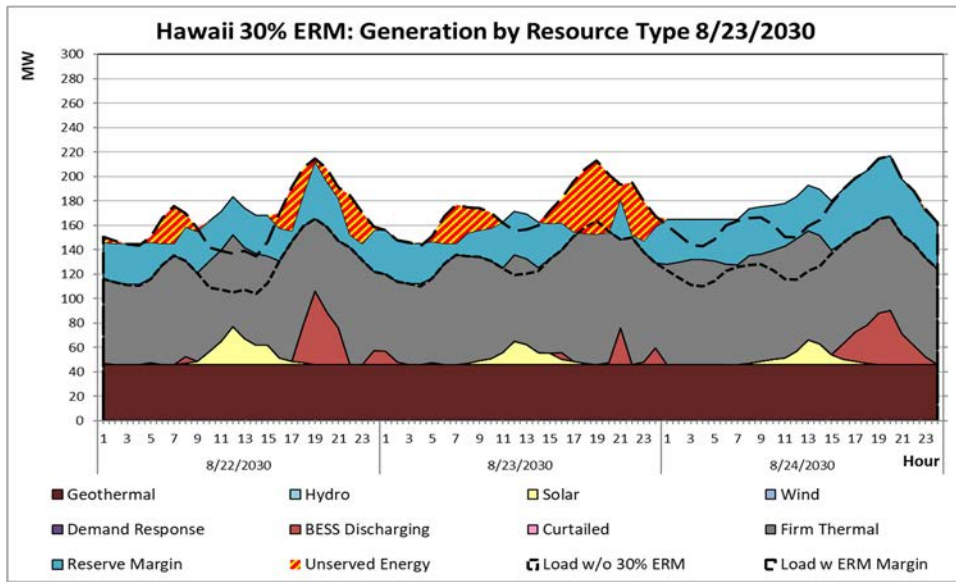
For Hawai'i Island, the ERM tests in PLEXOS demonstrated in Table C-15, that the resource plans did not meet the target ERM that was input into RESOLVE. However, when the resource plans were evaluated as a production simulation in PLEXOS, shown in Table C - 17 and Figure C- 8, unserved energy was not observed. In addition to the ERM target cases, the plans developed using the production profiles instead of HDCs and assuming no thermal resource candidates were able to serve load in all hours under normal production simulation conditions. The plan was developed assuming no thermal resource candidates, and demand was able to be met only after building a significant amount of PV+BESS capacity. As a sensitivity, the planned maintenance was swapped for a general outage that could be scheduled by PLEXOS. At lower ERM percentages, there was some unserved energy indicating that the appropriate ERM target is sensitive to planned outages.

The daily charts below provide a deeper dive into the results of the ERM Test and Stochastic Outage Production Simulation. Using the 30% ERM target case, the ERM Test indicated that the Energy Reserve Margin was violated in several hours, noted by the red-yellow hashed areas, when the available resources needed to serve the load plus 30% margin and variable renewable resources were limited by their HDCs.



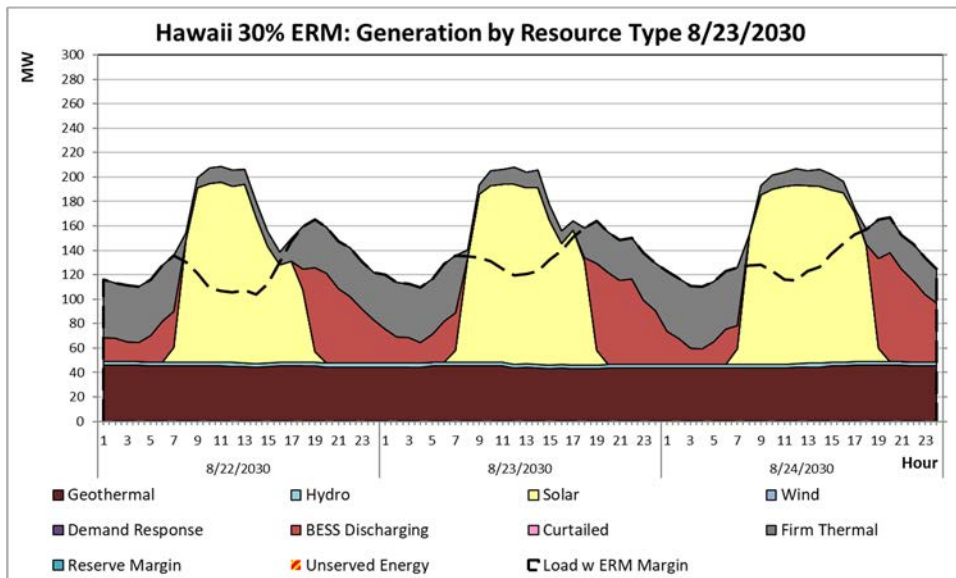


Figure C- 9: Hawai'i Island ERM Test Daily Chart



However, in the Stochastic Outage Production Simulation, no unserved energy was observed on the same set of days as the ERM Test when only serving forecasted load but including forced outages of thermal units and full production profiles of the variable renewables as the HDCs and ERM ensured that sufficient capacity was made available during the development of the resource plan.

Figure C- 10: Hawai'i Island Stochastic Outage Production Simulation Daily Chart



## Maui

Table C - 18 shows the resource plans based on the RESOLVE modeling for the seven different cases that were modeled. Each case assumes the ERM target indicated and an HDC using the 2 sigma profiles for PV, 1 sigma profiles for wind, except the Production Profile case where production profiles were applied in lieu of an HDC. The Remove Thermal Candidates case does not allow thermal generation to be built by the model to test how ERM is met through other resource technologies.

Table C - 18: RESOLVE Capacity Expansion Plans for Maui

Island (MW)	0% ERM	10% ERM	20% ERM	30% ERM	40% ERM	Production Profile (30% ERM)	Remove Thermal Candidates (30% ERM)
Existing Thermal Capacity	241	241	241	241	241	241	241
Thermal Capacity Removed (-)	-117	-102	-90	-75	-65	-127	-65
Remaining Thermal Capacity	124	138	151	165	175	114	175
Planned DR Capacity	5	5	5	5	5	5	5
Planned PV Capacity	21	21	21	21	21	21	21
Planned Wind Capacity	42	42	42	42	42	42	42
Planned PV+BESS Capacity	200	200	200	200	200	200	200
Planned BESS Capacity	40	40	40	40	40	40	40
New Thermal Capacity (+)	0	0	0	0	0	0	0
New BESS Capacity (+)	0	0	0	0	0	0	0
New PV+BESS Capacity (+)	0	0	0	0	0	0	42 MW, 4hr 9 MW, 6hr
New Wind Capacity (+)	0	0	0	0	0	0	0

In resource plans where thermal candidate resources were not allowed to be built, RESOLVE selected 42 MW of PV paired with 4-hour BESS and 9 MW of PV paired with 6-hour BESS at a 30% ERM. In the base 30% ERM case, RESOLVE did not select any thermal capacity. In the resource plans that include a 30% ERM target and production profiles for variable renewables (no HDCs assumed), no thermal capacity nor paired PV with storage was built.

Table C - 19 and Table C - 20 show the results of the RESOLVE cases shown above evaluated in PLEXOS. The purpose of these runs was to evaluate whether RESOLVE is building (under or over) the capacity needed to satisfy the ERM target, and whether there was unserved energy when evaluating each hour of the year. The PLEXOS model was run to dispatch units to explicitly meet the ERM target i.e. load plus margin.

Table C - 19: PLEXOS ERM Test on RESOLVE Maui Plans

ERM Cases	0% ERM	10% ERM	20% ERM	30% ERM	40% ERM
Pass / Fail	FAIL	FAIL	FAIL	FAIL	FAIL
Estimated ERM Level (%)	-8%	4%	14%	20%	26%
Max Hourly Shortfall (MW)	55	67	63	78	77
Max Daily Unserved Energy (MWh)	237	111	208	382	857
Annual Unserved Energy (MWh)	1,768	678	1,008	1,460	2,448
Annual Unserved Hours (Hrs)	118	12	66	81	3,411



Table C – 20: PLEXOS ERM Test on RESOLVE Maui Plans

ERM Cases	1 Std Dev PV HDC	Production Profile (30% ERM)	Remove Thermal Candidates (30% ERM)
Pass / Fail	PASS	FAIL	PASS
Estimated ERM Level (%)	32%	28%	34%
Max Hourly Shortfall (MW)	0	27	0
Max Daily Unserved Energy (MWh)	0	41	0
Annual Unserved Energy (MWh)	0	64	0
Annual Unserved Hours (Hrs)	0	6	0

For Maui, the ERM tests in PLEXOS demonstrated in Table C - 19 that the resource plans did not meet the target ERM that was input into RESOLVE. Table C - 20 shows that using one sigma standard deviations for the HDCs reduced the difference between the effective and target ERM but was still not met. However, in Table C - 21 and Table C - 22 when the resource plans were evaluated as a production simulation in PLEXOS, no unserved energy was observed. In addition to the ERM target cases, the plans developed using the production profiles instead of HDCs and assuming no thermal resource candidates was able to serve load in all hours. As a sensitivity, the planned maintenance was swapped for a general outage that could be scheduled by PLEXOS.

Table C – 21: PLEXOS Stochastic Outage Production Simulation on RESOLVE Maui Plans

Production Simulation with 15 Outage Loops	0% ERM	10% ERM	20% ERM	30% ERM	40% ERM
Annual Unserved Energy (MWh)	0	0	0	0	0
Annual Unserved Hours (Hrs)	0	0	0	0	0

Table C – 22: PLEXOS Stochastic Outage Production Simulation on RESOLVE Maui Plans

Production Simulation with 15 Outage Loops	1 Std Dev PV HDC	Production Profile (30% ERM)	Remove Thermal Candidates (30% ERM)
Annual Unserved Energy (MWh)	0	0	0
Annual Unserved Hours (Hrs)	0	0	0

Table C - 23 and Table C - 24 show that at lower ERM percentages up to 10%, there was some unserved energy indicating that the appropriate ERM target is sensitive to planned outages.

Table C – 23: Supplemental PLEXOS Stochastic Outage Production Simulation on RESOLVE Maui Plans

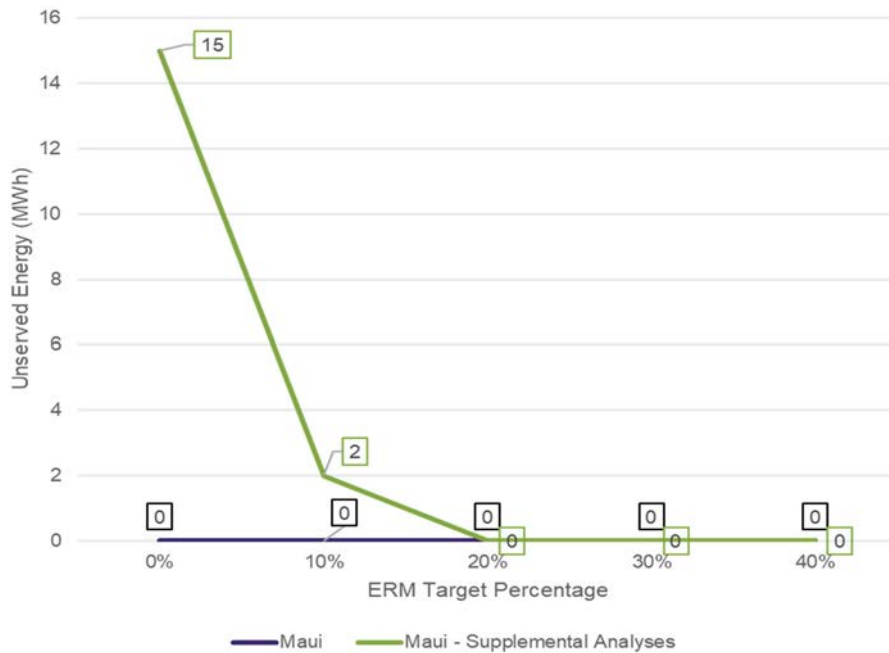
Production Simulation with 15 Outage Loops	0% ERM	10% ERM	20% ERM	30% ERM	40% ERM
Annual Unserved Energy (MWh)	15	2	0	0	0
Annual Unserved Hours (Hrs)	0.8	0.1	0	0	0



Table C - 24: Supplemental PLEXOS Stochastic Outage Production Simulation on RESOLVE Maui Plans

Production Simulation with 15 Outage Loops	1 Std Dev PV HDC	Production Profile (30% ERM)	Remove Thermal Candidates (30% ERM)
Annual Unserved Energy (MWh)	0	0	0
Annual Unserved Hours (Hrs)	0	0	0

Figure C- 11: Maui Unserved Energy by ERM Percentage for PLEXOS Stochastic Outage Production Simulation

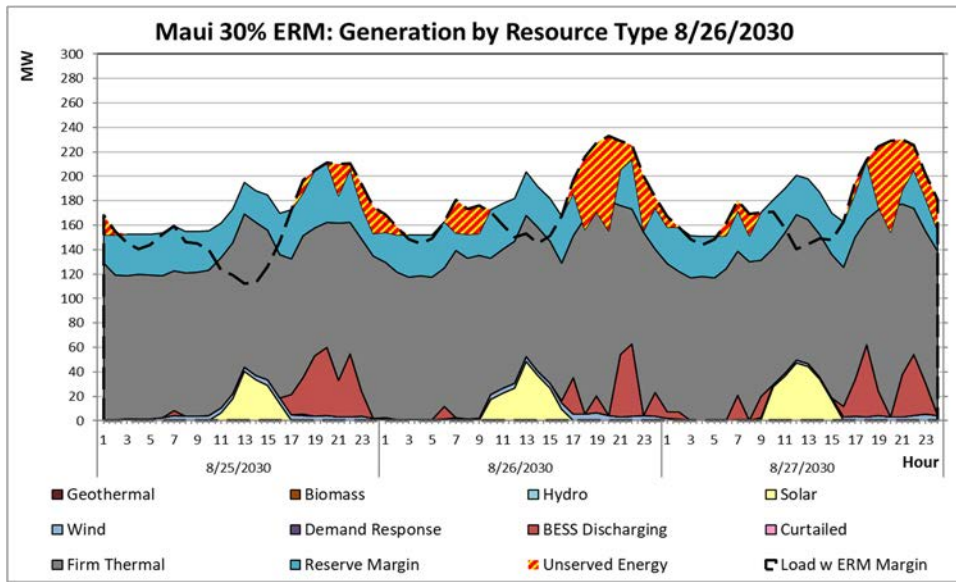


The Maui stochastic outage production simulations resulted in no unserved energy in plans above 10% ERM due to multiple uncorrelated PV hourly pattern files which together eliminated days of low PV output. As a result, the risk of insufficient energy due to low PV output days is not reflected in the stochastic production simulation results for Maui.

The daily charts below provide a deeper dive into the results of the ERM Test and Stochastic Outage Production Simulation. Using the 30% ERM target case, the ERM Test indicated that the Energy Reserve Margin was violated in several hours, noted by the red-yellow hashed areas, when the available resources needed to serve the load plus 30% margin and variable renewable resources were limited by their HDCs.

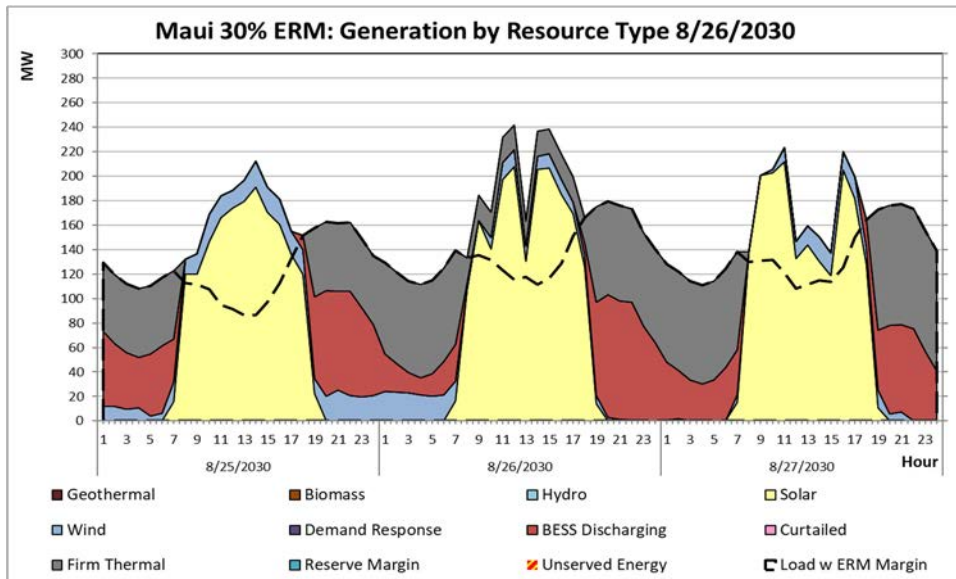


Figure C- 12: Maui ERM Test Daily Chart



However, in the Stochastic Outage Production Simulation, no unserved energy was observed on the same set of days as the ERM Test when only serving forecasted load but including forced outages of thermal units and full production profiles of the variable renewables as the HDCs and ERM ensured that sufficient capacity was made available during the development of the resource plan.

Figure C- 13: Maui Stochastic Outage Production Simulation Daily Chart



### Lāna‘i

Table C - 25 shows the resource plans based on the RESOLVE modeling for the six different cases that were modeled. Each case assumes the ERM target indicated and an HDC using the 2 sigma profiles for PV, 1 sigma profiles for wind, except the Production Profile case where production profiles were applied in lieu of an HDC. The Remove Thermal Candidates case does not allow thermal generation to be built by the model to test how ERM is met through other resource technologies.

Table C - 25: RESOLVE Capacity Expansion Plans for Lāna‘i

Island (MW)	60% ERM	40% ERM	20% ERM	0% ERM	Production Profile (60% ERM)	Remove Thermal Candidates (60% ERM)
Existing Thermal Capacity	10.4	10.4	10.4	10.4	10.4	10.4
Thermal Capacity Removed (-)	10.4	10.4	10.4	10.4	10.4	10.4
Remaining Thermal Capacity	0	0	0	0	0	0
Planned DR Capacity	0	0	0	0	0	0
Planned PV Capacity	0	0	0	0	0	0
Planned Wind Capacity	0	0	0	0	0	0
Planned PV+BESS Capacity	15.8	15.8	15.8	15.8	15.8	15.8
New Thermal Capacity (+)	8.8	6.6	6.6	4.4	6.6	0
New BESS Capacity (+)	0	0	0	0	0	0
New PV+BESS Capacity (+)	0.5 MW, 2hr	0.5 MW, 2hr	0.5 MW, 2hr	0.5 MW, 2hr	0.5 MW, 2hr	87 MW, 6hr 89 MW, 8hr
New Wind Capacity (+)	0	0	0	0	0	0

In resource plans where thermal candidate resources were not allowed to be built, RESOLVE selected 87 MW of PV paired with 6-hour BESS and 89 MW of PV paired with 8-hour BESS at a 60% ERM. In the base 60% ERM case, RESOLVE selected 8.8 MW of thermal capacity which provides a rough equivalent of 8.8 MW of firm capacity to 176 MW of PV paired with BESS (87 MW of PV paired with 6-hour BESS plus 89 MW of PV paired with 8-hour BESS). In the resource plans that include a 60% ERM target and production profiles for variable renewables (no HDCs assumed), 6.6 MW of thermal capacity continued to be built.

Table C - 26 and Table C - 27 show the results of the RESOLVE cases shown above evaluated in PLEXOS. The purpose of these runs was to evaluate whether RESOLVE is building (under or over) the capacity needed to satisfy the ERM target, and whether there was unserved energy when evaluating each hour of the year. The PLEXOS model was run to dispatch units to explicitly meet the ERM target i.e. load plus margin.





Table C – 26: PLEXOS ERM Test on RESOLVE Lāna‘i Plans

ERM Cases	0% ERM	20% ERM	40% ERM	60% ERM
Pass / Fail	FAIL	FAIL	FAIL	FAIL
Estimated ERM Level (%)	-50%	0%	0%	50%
Max Hourly Shortfall (MW)	4.0	3.0	4.2	2.9
Max Daily Unserved Energy (MWh)	54	23	45	14
Annual Unserved Energy (MWh)	83	223	1163	56
Annual Unserved Hours (Hrs)	994	239	831	57

Table C – 27: PLEXOS ERM Test on RESOLVE Lāna‘i Plans

ERM Cases	1 Std Dev PV HDC (60% ERM)	Production Profile (60% ERM)	Remove Thermal Candidates (60% ERM)
Pass / Fail	PASS	FAIL	FAIL
Estimated ERM Level (%)	80%	50%	50%
Max Hourly Shortfall (MW)	0	1.3	8.3
Max Daily Unserved Energy (MWh)	0	1.3	28
Annual Unserved Energy (MWh)	0	1.3	99
Annual Unserved Hours (Hrs)	0	1	29

Table C – 28: PLEXOS Stochastic Outage Production Simulation on RESOLVE Lāna‘i Plans

Production Simulation with 15 Outage Loops	0% ERM	20% ERM	40% ERM	60% ERM
Annual Unserved Energy (MWh)	6.6	0	0	0
Annual Unserved Hours (Hrs)	3.7	0	0	0

Table C – 29: PLEXOS Stochastic Outage Production Simulation on RESOLVE Lāna‘i Plans

Production Simulation with 15 Outage Loops	1 Std Dev PV HDC (60% ERM)	Production Profile (60% ERM)	Remove Thermal Candidates (60% ERM)
Annual Unserved Energy (MWh)	0	0	0
Annual Unserved Hours (Hrs)	0	0	0

Table C – 30: Supplemental PLEXOS Stochastic Outage Production Simulation on RESOLVE Lāna‘i Plans

Production Simulation with 15 Outage Loops	0% ERM	20% ERM	40% ERM	60% ERM
Annual Unserved Energy (MWh)	11.1	0.3	0.3	0
Annual Unserved Hours (Hrs)	6.1	0.2	0.2	0



Table C – 31: Supplemental PLEXOS Stochastic Outage Production Simulation on RESOLVE Lānaʻi Plans

Production Simulation with 15 Outage Loops	1 Std Dev PV HDC (60% ERM)	Production Profile (60% ERM)	Remove Thermal Candidates (60% ERM)
Annual Unserved Energy (MWh)	0	0.3	0
Annual Unserved Hours (Hrs)	0	0.1	0

Figure C- 14: Lānaʻi Unserved Energy by ERM Percentage for PLEXOS Stochastic Outage Production Simulation



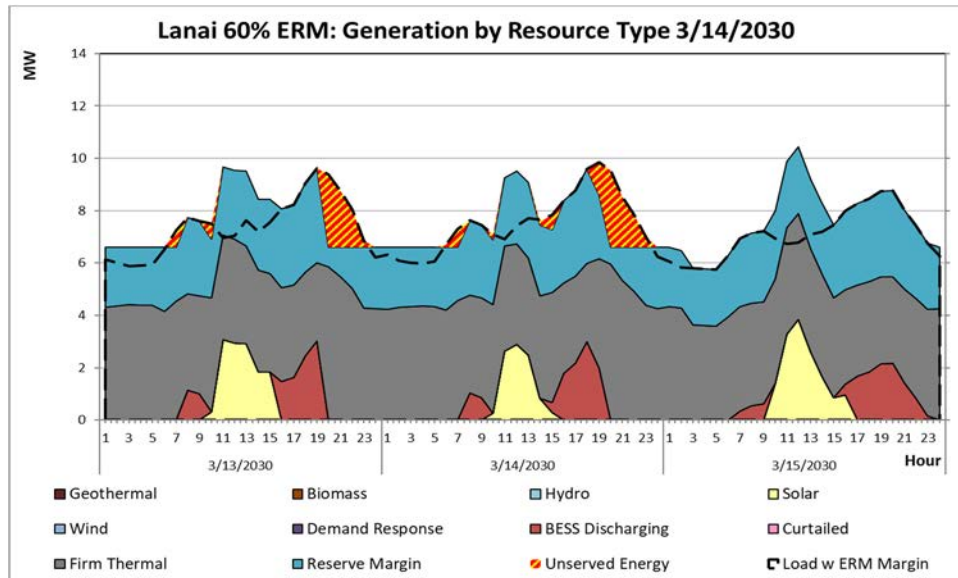
For Lānaʻi, the ERM tests in PLEXOS showed that the resource plans did not meet the target ERM that was input into RESOLVE. Using one sigma standard deviations for the HDCs reduced the difference between the effective and target ERM and did meet the 60% ERM target. However, when the resource plans were evaluated as a production simulation in PLEXOS, unserved energy was significantly reduced from 20% to 60% ERM which supports the reasonableness of a 60% ERM. In addition to the ERM target cases, the plans developed using the production profiles instead of HDCs and assuming no thermal resource candidates was able to serve load in all hours. For the no thermal resource candidate case, this was only after building a significant amount of PV+BESS capacity with a longer duration storage. This demonstrates the flexibility of the ERM criteria to evaluate different resource options as the portfolio mix is expected to change over time. As a sensitivity, the planned maintenance was swapped for a general maintenance outage that could be scheduled by PLEXOS. At lower ERM percentages up to 40%, there was some unserved energy indicating that the appropriate ERM target is sensitive to planned outages.





The daily charts below provide a deeper dive into the results of the ERM Test and Stochastic Outage Production Simulation. Using the 60% ERM target case, the ERM Test indicated that the Energy Reserve Margin was violated in several hours, noted by the red-yellow hashed areas, when the available resources needed to serve the load plus 60% margin and variable renewable resources were limited by their HDCs.

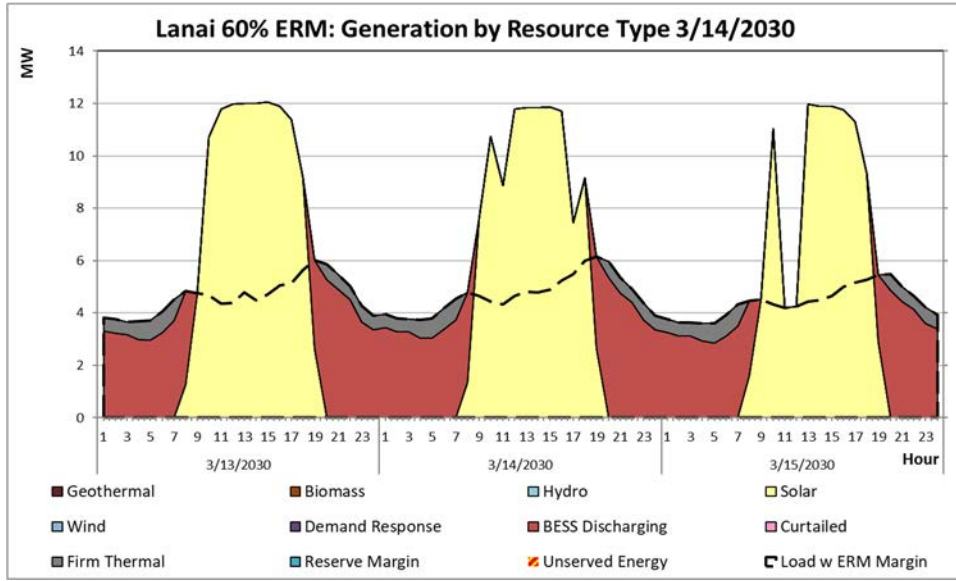
Figure C- 15: Lānaʻi ERM Test Daily Chart



However, in the Stochastic Outage Production Simulation, no unserved energy was observed on the same set of days as the ERM Test when only serving forecasted load but including forced outages of thermal units and full production profiles of the variable renewables as the HDCs and ERM ensured that sufficient capacity was made available during the development of the resource plan.



Figure C- 16: Lānaʻi Stochastic Outage Production Simulation Daily Chart



### Molokaʻi

Table C - 32 shows the resource plans based on the RESOLVE modeling for the six different cases that were modeled. Each case assumes the ERM target indicated and an HDC using the 2 sigma profiles for PV, 1 sigma profiles for wind, except the Production Profile case where production profiles were applied in lieu of an HDC. The Remove Thermal Candidates case does not allow thermal generation to be built by the model to test how ERM is met through other resource technologies.

Table C - 32: RESOLVE Capacity Expansion Plans for Molokaʻi

Island (MW)	60% ERM	40% ERM	20% ERM	0% ERM	Production Profile (60% ERM)	Remove Thermal Candidates (60% ERM)
Existing Thermal Capacity	15.2	15.2	15.2	15.2	15.2	15.2
Thermal Capacity Removed (-)	15.2	15.2	15.2	15.2	15.2	15.2
Remaining Thermal Capacity	0.0	0.0	0.0	0.0	0.0	0.0
Planned DR Capacity	0.0	0.0	0.0	0.0	0.0	0.0
Planned PV Capacity	0.3	0.3	0.3	0.3	0.3	0.3
Planned Wind Capacity	0.0	0.0	0.0	0.0	0.0	0.0
Planned PV+BESS Capacity	7.2	7.2	7.2	7.2	7.2	7.2
New Thermal Capacity (+)*	6.6	4.4	4.4	4.4	4.4	0.0
New BESS Capacity (+)	0.3	0.3	0.3	0.5	0.3	0.7
New PV+BESS Capacity (+)	1.0 MW, 2hr	1.0 MW, 2hr	1.0 MW, 2hr	0.8 MW, 2hr	0.9 MW, 4hr 1.6 MW, 6hr	1 MW, 6hr 136 MW, 8hr
New Wind Capacity (+)	0.0	0.0	0.0	0.0	0.2	0.0



In resource plans where thermal candidate resources were not allowed to be built, RESOLVE selected 1 MW of PV paired with 6-hour BESS and 136 MW of PV paired with 8-hour BESS at a 60% ERM. In the base 60% ERM case, RESOLVE selected 6.6 MW of thermal capacity which provides a rough equivalent of 6.6 MW of firm capacity to 137 MW of PV paired with BESS (1 MW of PV paired with 6-hour BESS plus 136 MW of PV paired with 8-hour BESS). In the resource plans that include a 60% ERM target and production profiles for variable renewables (no HDCs assumed), 4.4 MW of thermal capacity continued to be built.

Table C - 33 and Table C - 34 show the results of the RESOLVE cases shown above evaluated in PLEXOS. The purpose of these runs was to evaluate whether RESOLVE is building (under or over) the capacity needed to satisfy the ERM target, and whether there was unserved energy when evaluating each hour of the year. The PLEXOS model was run to dispatch units to explicitly meet the ERM target i.e. load plus margin.

Table C - 33: PLEXOS ERM Test on RESOLVE Moloka'i Plans

ERM Cases	0% ERM	20% ERM	40% ERM	60% ERM
Pass / Fail	FAIL	FAIL	FAIL	FAIL
Estimated ERM Level (%)	-40%	-40%	-40%	10%
Max Hourly Shortfall (MW)	3.1	4.2	5.3	4.1
Max Daily Unserved Energy (MWh)	31	49	71	36
Annual Unserved Energy (MWh)	772	1,726	4,322	672
Annual Unserved Hours (Hrs)	643	1277	3,107	589

Table C - 34: PLEXOS ERM Test on RESOLVE Moloka'i Plans

ERM Cases	1 Std Dev PV HDC (60% ERM)	Production Profile (60% ERM)	Remove Thermal Candidates (60% ERM)
Pass / Fail	FAIL	FAIL	FAIL
Estimated ERM Level (%)	30%	40%	40%
Max Hourly Shortfall (MW)	4.6	4.4	3.0
Max Daily Unserved Energy (MWh)	17	22	9
Annual Unserved Energy (MWh)	365	214	72
Annual Unserved Hours (Hrs)	296	52	99

Table C - 35: PLEXOS Stochastic Outage Production Simulation on RESOLVE Moloka'i Plans

Production Simulation with 15 Outage Loops	0% ERM	20% ERM	40% ERM	60% ERM
Annual Unserved Energy (MWh)	86	83	83	0
Annual Unserved Hours (Hrs)	40.3	38.3	38.3	0



Table C – 36: PLEXOS Stochastic Outage Production Simulation on RESOLVE Moloka‘i Plans

Production Simulation with 15 Outage Loops	1 Std Dev PV HDC	Production Profile	Remove Thermal Candidates
Annual Unserved Energy (MWh)	0	35	0
Annual Unserved Hours (Hrs)	0	25.1	0

Table C – 37: Supplemental PLEXOS Stochastic Outage Production Simulation on RESOLVE Moloka‘i Plans

Production Simulation with 15 Outage Loops	0% ERM	20% ERM	40% ERM	60% ERM
Annual Unserved Energy (MWh)	130	125	125	7
Annual Unserved Hours (Hrs)	70.9	68.1	67.3	4

Table C – 38: Supplemental PLEXOS Stochastic Outage Production Simulation on RESOLVE Moloka‘i Plans

Production Simulation with 15 Outage Loops	1 Std Dev PV HDC (60% ERM)	Production Profile (60% ERM)	Remove Thermal Candidates (60% ERM)
Annual Unserved Energy (MWh)	7	62	0
Annual Unserved Hours (Hrs)	4	35.1	0

Figure C– 17: Moloka‘i Unserved Energy by ERM Percentage for PLEXOS Stochastic Outage Production Simulation



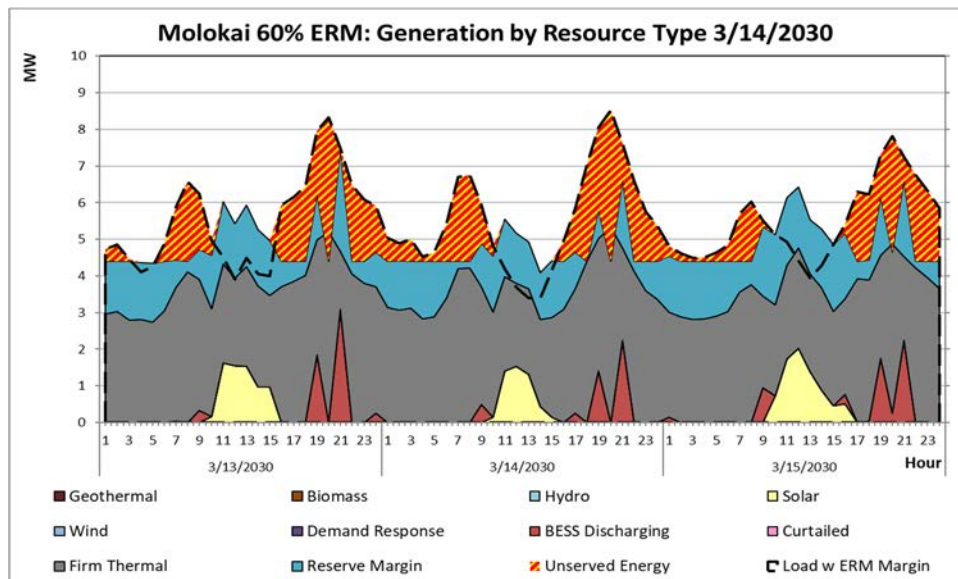
For Moloka‘i, the ERM tests in PLEXOS showed that the resource plans did not meet the target ERM that was input into RESOLVE. Using one sigma standard deviations for the HDCs reduced the difference between the effective and target ERM and but still did not meet the 60% ERM



target. However, when the resource plans were evaluated as a production simulation in PLEXOS, unserved energy was significantly reduced at 60% ERM which supports the reasonableness of a 60% ERM. In addition to the ERM target cases, the plan developed using the production profiles instead of HDCs was not able to serve load in all hours although the plan developed assuming no thermal resource candidates was able to, after building a significant amount of PV+BESS capacity with a longer duration storage. This demonstrates the flexibility of the ERM criteria to evaluate different resource options as the portfolio mix is expected to change over time. As a sensitivity, the planned maintenance was swapped for a general maintenance outage that could be scheduled by PLEXOS. At all ERM percentages up to 60%, there was some unserved energy indicating that the appropriate ERM target is sensitive to planned outages.

The daily charts below provide a deeper dive into the results of the ERM Test and Stochastic Outage Production Simulation. Using the 60% ERM target case, the ERM Test indicated that the Energy Reserve Margin was violated in several hours, noted by the red-yellow hashed areas, when the available resources needed to serve the load plus 60% margin and variable renewable resources were limited by their HDCs.

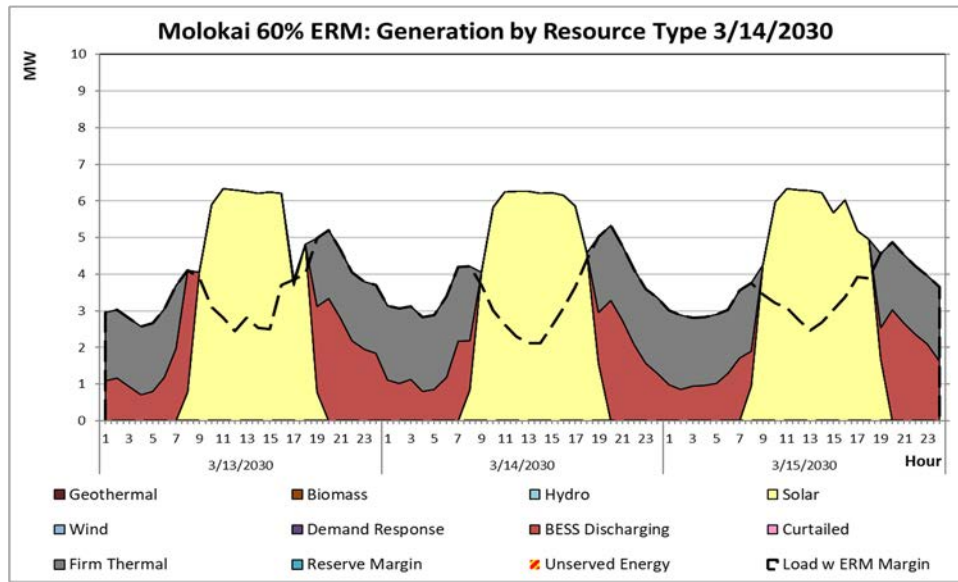
Figure C- 18: Moloka‘i ERM Test Daily Chart



However, in the Stochastic Outage Production Simulation, no unserved energy was observed on the same set of days as the ERM Test when only serving forecasted load but including forced outages of thermal units and full production profiles of the variable renewables as the HDCs and ERM ensured that sufficient capacity was made available during the development of the resource plan.



Figure C- 19: Moloka‘i Stochastic Outage Production Simulation Daily Chart



### C.1.11. CONCLUSIONS AND RECOMMENDATIONS

The Company conducted this analysis to develop a reasonable capacity planning criteria that could be adopted for the first cycle of Integrated Grid Planning. Anticipated near term changes in the Company’s resource mix to include large amounts of variable renewables and battery energy storage will require a new type of criteria that can consider the contributions of energy limited resources providing capacity as well as capacity needs that may not occur at system peak but at other hours of the day due to energy limitations rather than capacity limitations. This is an evolution of past planning criteria that primarily accounted for conventional thermal resources capable of providing limitless energy, if not on outage, to serve peak demand.

Recognizing that the future resource mix may dramatically change from today, the ERM criteria purposefully constructed with built in safety margins to account for uncertainty in the production from variable renewable resources due to limited historical records for existing projects, near term additions of large hybrid solar and energy storage plants that are an entirely new resource with which to develop operational experience, and uncertain impacts of climate change on the future production of variable renewable resources.

In future planning cycles, further refinement of reliability planning criteria may be warranted in the future once the Company gains operational data and experience operating novel (solar + BESS) technologies and generally has a more established production record for variable renewable resources.





Key results of this analysis are summarized below:

1. For O‘ahu, Hawai‘i Island, and Maui, 30% ERM and HDC is a reasonable long term metric based on ERM analysis conducted. ERM of 40% may be reasonable if added reliability and resilience is desired. Similarly, 60% ERM and HDC is a reasonable long term metric for Moloka‘i and Lāna‘i.
2. 30% ERM is rooted in historical planning for the loss of largest generator and intended to cover a range of abnormal events such as forced outages, unplanned maintenance, atypical weather, battery energy storage failures, forecast uncertainty. This allows ERM to evaluate different resource options as the portfolio mix changes over the planning horizon.
3. HDC is a reasonable approach to mitigate potential impacts of low solar and wind output and their ability to charge BESS.
4. ERM and HDC help to provide a balanced portfolio of resources that can mitigate risks of reliance on a single technology.
5. Firm capacity assets play a critical role during periods of low wind and solar availability.
6. Variable renewables reduce the amount of replacement thermal capacity that is needed to meet ERM targets
7. Higher ERM targets require more firm thermal capacity than lower ERM targets

For the first cycle of IGP, the Company recommends the following based on recommendations and feedback from the TAP and STWG:

#### Capacity Expansion Analyses in RESOLVE

- For the purposes of capacity expansion planning in the RESOLVE model, the Company recommends using the ERM methodology as previously described, with ERM targets validated by the TAP,<sup>61</sup> and HDC’s validated by supplemental testing. (e.g., 30% ERM target for O‘ahu, Hawai‘i Island, and Maui and 60% ERM target for Moloka‘i and Lāna‘i, and 2 sigma PV and 1 sigma wind HDCs)
  - The 30% / 60% ERM targets were initially based on providing replacement energy for the loss of the largest unit on each island. The 30% targets were then validated and deemed reasonable based on independent analyses conducted by HNEI and Telos Energy.
  - Regarding the use of HDCs (2-sigma for PV and 1-sigma for Wind), the Company tested 30% ERM on O‘ahu for year 2030 using the proposed HDCs, substituting 1-sigma for PV, and replacing HDC with production profiles for wind and PV. In all 3 cases, the Company removed 387 MW of existing firm thermal capacity from the system (simulating a year 2030 case). The resource plans developed by the RESOLVE model did not result in any significant overbuilding when confirmed in the ERM test and production simulation conducted in PLEXOS. In

---

<sup>61</sup> See Telos Energy recommendations at pages 7, 9–10, [https://www.hawaiianelectric.com/documents/clean\\_energy\\_hawaii/integrated\\_grid\\_planning/stakeholder\\_engagement/technical\\_advisory\\_panel/20211101\\_tap\\_hnei\\_grid\\_integration\\_erm\\_calibration.pdf](https://www.hawaiianelectric.com/documents/clean_energy_hawaii/integrated_grid_planning/stakeholder_engagement/technical_advisory_panel/20211101_tap_hnei_grid_integration_erm_calibration.pdf).



the 2-sigma PV, 1-sigma wind case, RESOLVE built a new 57 MW firm capacity generator. In the 1-sigma PV and production profile case the model chose not to build the 57 MW of firm capacity. Having an additional 57 MW of firm capacity is relatively marginal given the size of the O`ahu system and may provide additional resilience benefits to customers that can serve the grid during an emergency situation (i.e., natural disasters damaging solar or wind plants, prolonged poor weather, etc.).

- The results for O`ahu described here are indicative of the results for Hawai`i Island, Maui, Moloka`i, and Lāna`i and in line with independent verification of the ERM conducted by Telos Energy for O`ahu and Maui.
- Further evaluation of the ERM with higher levels of variable renewables on the system is recommended once operational performance is realized, and real operational experience is gained with the hybrid solar and storage plants that are expected to come online in the next few years. Fundamentally, reliability analysis assesses the risk of having sufficient generating resources to meet customer demand. Using the recommended approach by the Company for the first IGP cycle appropriately mitigates the risk of uncertainty of variable renewable contribution to demand at each hour of the year. As the first cycle of IGP is expected to focus on the next 5-10 year action plan there will be opportunities to make adjustments over the next 10-20 years when such operational experience is collected. In other words, using the approach proposed for this first IGP cycle does not crowd out future opportunities or the Company's ability to accelerate other generating unit retirements should operational experience allow us to do so.

However, if the Commission is inclined to not adopt the Company's ERM and/or HDC recommendation for use in RESOLVE for this first IGP cycle, then the Company proposes the following alternative to further analyze HDCs directly in line with the TAP's recommendations for this first IGP cycle. However, additional time will be needed to complete the additional analysis. This alternative method relies upon simulated data to characterize the capacity value of variable renewables in lieu of actual production or the appropriate margins to mitigate errors in simulated data. Should real operational performance of existing variable renewables and new hybrid solar and storage plants prove that their calculated capacity values are overstated, the planning criteria may be violated and retirement of fossil generation may be delayed or an expedited procurement of new resources for reliability and capacity needs may be triggered.

- Evaluate alternative calculations for the HDC
  - The TAP expressed a desire to improve data availability for the variable renewable production using simulated data provided by NREL, given that the Company's historical records are limited.
  - An alternate HDC will be developed using simulated NREL weather data to expand the available dataset used in its calculation. The calculation method of this HDC will be as previously described.





- The hourly production will be considered directly in the HDC calculation because the NREL weather data includes several years' worth of data. Although the TAP suggested a monthly like-hour approach to group hourly data, it will not need to be used to increase the number of available data points since the larger NREL simulated data set is being used.
- The HDC will be expressed in terms of exceedance probability rather than standard deviation deductions. The effects of varying statistical confidence intervals on the available variable renewable production potential will be evaluated comparing exceedance probability vs actual production.
- Varying confidence intervals will be evaluated against historical prolonged or extreme weather events that had low wind or solar output to mitigate or account for risk associated with poor weather that would cause low solar or wind output.
- Improvements to accuracy, data quality, and methodology that impact the dependable capacity estimates of wind and solar as described above may be recommended for use as HDCs in RESOLVE.

#### Resource Adequacy Analyses and Validation in PLEXOS

- Conduct a resource adequacy evaluation utilizing the hourly chronological PLEXOS model and probabilistic modeling techniques in selected plan years
  - Telos Energy noted that while ERM can be used in RESOLVE, a resource adequacy back check is still needed to confirm the reliability of the resource portfolio.<sup>62</sup> Per the IGP modeling framework in Figure 3-1, this would entail developing a resource plan in RESOLVE and evaluating the reliability of the resulting plan in PLEXOS, with the understanding that the RESOLVE model cannot be used to solve for all situations and other tools should be integrated into the overall process.<sup>63</sup>
  - The TAP recognized that resource adequacy evaluation methods using probabilistic modeling can be used to validate the deterministic approach to develop long term plans.
- Calculate unserved energy, unserved energy hours, LOLE, and effective ERM metrics for the evaluated resource plan
- Include the probabilistic modeling of forced outages for thermal units and weather years for variable renewable production
  - Initial comments from the TAP provided in the TAP Resource Adequacy Subgroup meeting on November 1, 2021 indicated that several stakeholders endorsed the probabilistic methodology utilized by Telos Energy to test multiple weather years for variable renewable production and multiple forced outage patterns for thermal units.
- Include the probabilistic modeling of forced outages for battery energy storage systems

---

<sup>62</sup> See Telos Energy recommendations at pages at 10.

<sup>63</sup> Grid Services and Planning Criteria Feedback filed on June 1, 2021 in Docket No. 2018-0165 at 4 and 10.



- Recognizing that storage resources may not exhibit perfect availability in actual implementation due to equipment failures,<sup>64</sup> an estimated nominal forced outage rate will be included to reflect an amount of unavailability. Grid-scale load shifting batteries are new to the electric utility industry and do not have a long track record of operations. Therefore, a forced outage rate based on operational experience is difficult to calculate in the near term so a nominal value such as 10% can be used initially until the industry gains sufficient experience to predict the reliability of battery storage systems.
- In the November 1, 2021 TAP Resource Adequacy Subgroup meeting, the TAP commented on the usage of mature vs. immature forced outage rates or including a longer mean time to repair as a consideration for hybrid plant outages.

### Future Considerations

- Future evaluation of HDC values for variable renewable resources can be analyzed for future IGP cycles as more historical performance data is collected.
- More analysis around wind resources and 20-years of wind data for both land-based wind and offshore wind

---

<sup>64</sup> While typical battery outages are expected to be a fraction of the total capacity for maintenance due to the modular nature of battery storage systems; there have been recent whole battery plant failures that warrant considering the availability of the battery. For example, <https://www.reuters.com/world/asia-pacific/fire-breaks-out-tesla-australia-mega-battery-during-testing-2021-07-30/>, <https://www.utilitydive.com/news/vistras-300-mw-moss-landing-storage-facility-remains-offline-after-overheating/606178/>, and <https://www.azcentral.com/story/money/business/energy/2019/04/23/arizona-public-service-provides-update-investigation-battery-fire-aps-surprise/3540437002/>



## Appendix D. Regulating Reserve Criteria

The purpose of the regulation criteria is to establish guidelines to minimize the risk of supply and demand imbalances by ensuring sufficient regulating reserves are available to the system in long-range planning studies. This criterion applies to standalone distributed energy resources (“DER”), standalone grid-scale solar resources, standalone grid-scale wind resources, and gross system load.

---

### D.1. BACKGROUND

The methodology being presented here is similar to the methodology used at ERCOT. To calculate their reserve requirement, they start by gathering historical 5-minute average load data, wind production data, and solar production data. They use that information to calculate the net load. Subsequently, they calculate the difference in net load between the previous 5 minutes and the next five minutes. They group these differences by hour and then further group them into negative differences for Regulation Down calculations and positive differences for Regulation Up calculations. For each group, the 95<sup>th</sup> percentile is calculated.

ERCOT then pulls the historical average 5-minute Regulation Up and Regulation Down deployments, groups these by hour, and also calculates the 95<sup>th</sup> percentile for each group. ERCOT takes the larger of the regulation calculated based on the net load change and the actual regulation deployment. This is the regulation that would be required based on the current operating system.

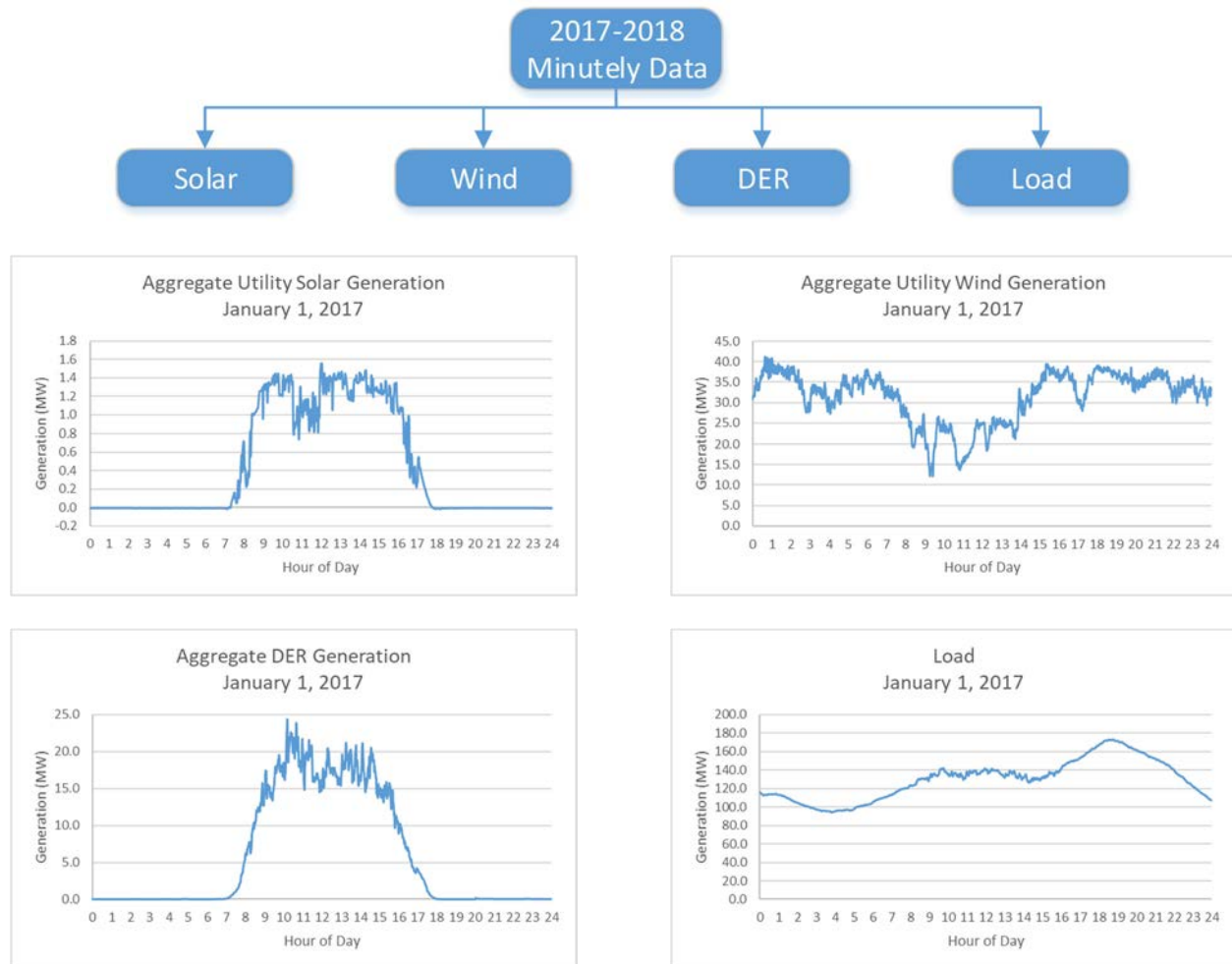
---

### D.2. METHODOLOGY

Similar to ERCOT, for O’ahu, Maui, and Hawai’i Island, we obtained minutely data for 2017 and 2018 for installed grid-scale solar projects, aggregated by island. The same was done for installed grid-scale wind projects. Minutely data for 2017 and 2018 was also obtained for gross load as well as estimated DER output. Aggregated grid-scale solar projects, aggregated grid-scale wind projects, aggregated DER, and gross load comprise the four categories used in this study. Shown below in Figure D- 1 is a sample day of the minutely data gathered for each of the categories.



Figure D- 1: Sample minutely data of aggregated grid-scale solar generation, aggregated grid-scale wind generation, aggregated grid-scale DER generation, and gross load for January 1, 2017



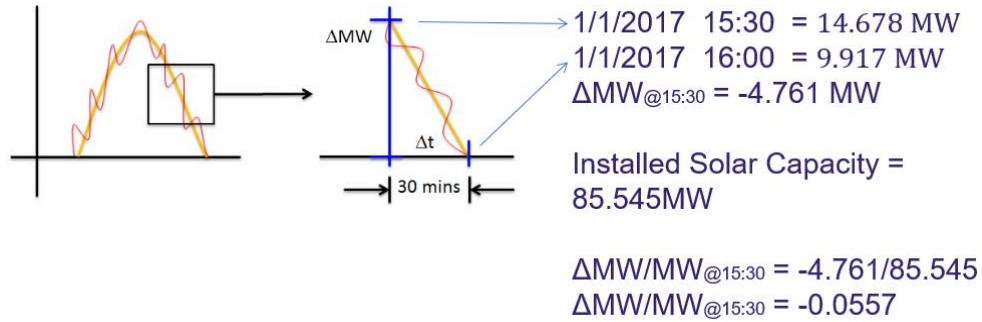
Due to the lack of data on Lānaʻi and Molokaʻi, Maui data for grid-scale solar projects and grid-scale wind projects was used. Lānaʻi and Molokaʻi also lacked minutely estimated DER generation, so net load was used in place of DER generation and gross load.

For Oʻahu and Maui, for each category, the change over a 30-minute time-interval was calculated. For Hawaiʻi Island, Molokaʻi, and Lānaʻi, the change was calculated over a 20-minute time-interval. These time-intervals were provided by our system operators and were based on the time they required to bring additional units online, if needed. Hawaiʻi Island, Molokaʻi, and Lānaʻi have a shorter time-interval because they have generators that can start faster than the generators on Oʻahu and Maui.

The change in renewable energy was then divided by the aggregated installed capacity to normalize it. In the case of load, the change was divided by the peak load. Figure D- 2, shown below, provides an example of the calculation done.

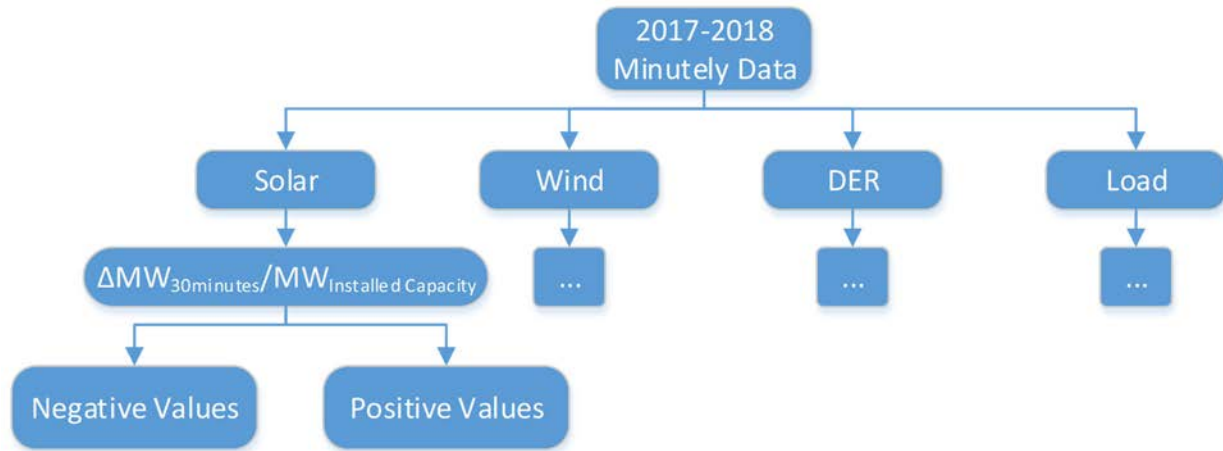


Figure D- 2: Sample calculation used to convert the minutely data into a unitized rate of change



As shown below in Figure D- 3, for each category, all the positive changes were grouped together, and all the negative changes were grouped together. The reason for this is because the direction of change dictates whether upward regulation or downward regulation is required. For the renewable categories, positive changes represented an increase in renewable generation, and consequently, the need for downward regulation. Conversely, negative changes represented a decrease in renewable generation, and consequently, the need for upward regulation. For changes in load, the opposite occurs. Positive changes in load represented a need for upward regulation and negative changes in load represented a need for downward regulation.

Figure D- 3: Grouping of the minutely data into positive and negative values<sup>65</sup>

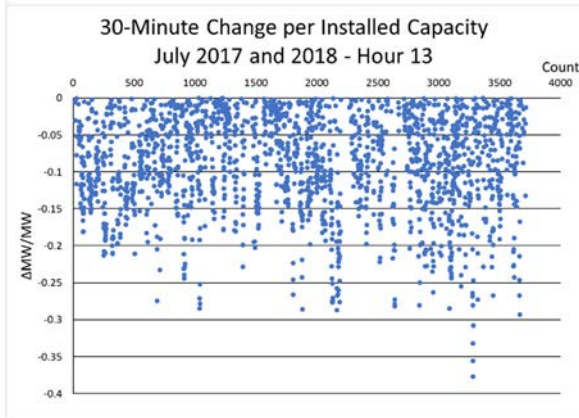
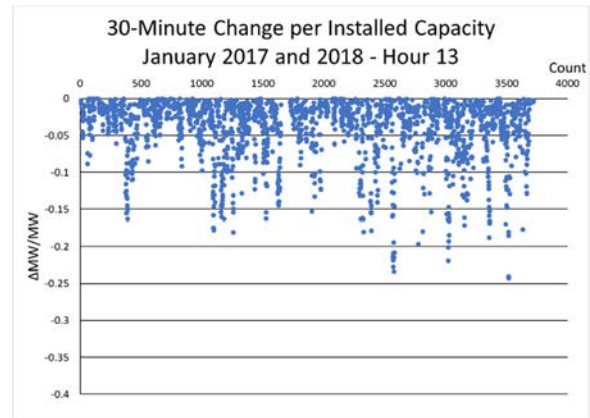
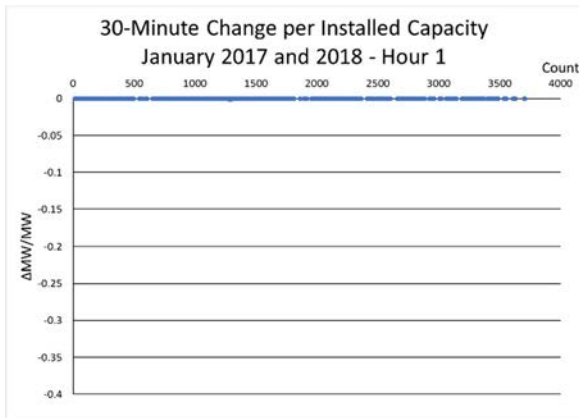
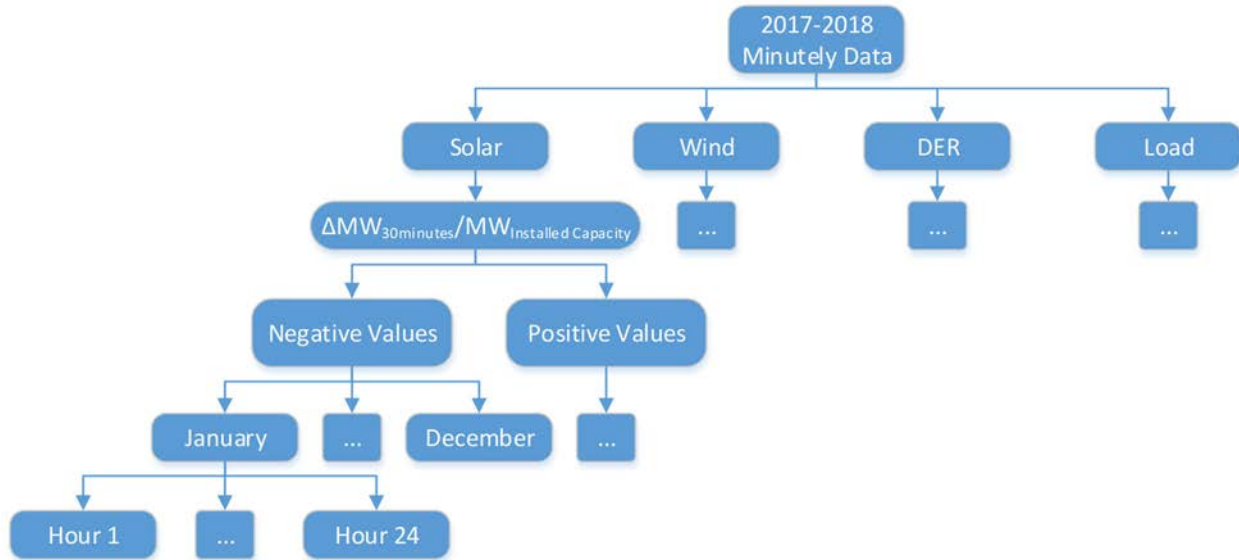


As shown below in Figure D- 4, the data was further segregated based on month of the year and hour of the day. This was done to ensure that any seasonal or hourly impact on renewable generation or load would be considered. For example, solar output is significantly different between January and July, and between midnight and noon, as shown in Figure D- 4.

<sup>65</sup> Positive changes in generation (negative changes in load) represent a need for downward regulation. Negative changes in generation (positive changes in load) represent a need for upward regulation.



Figure D- 4: Segregation of data based on the month of the year and time of the day. This was done to take into consideration any influence that these parameters have on renewable generation and load

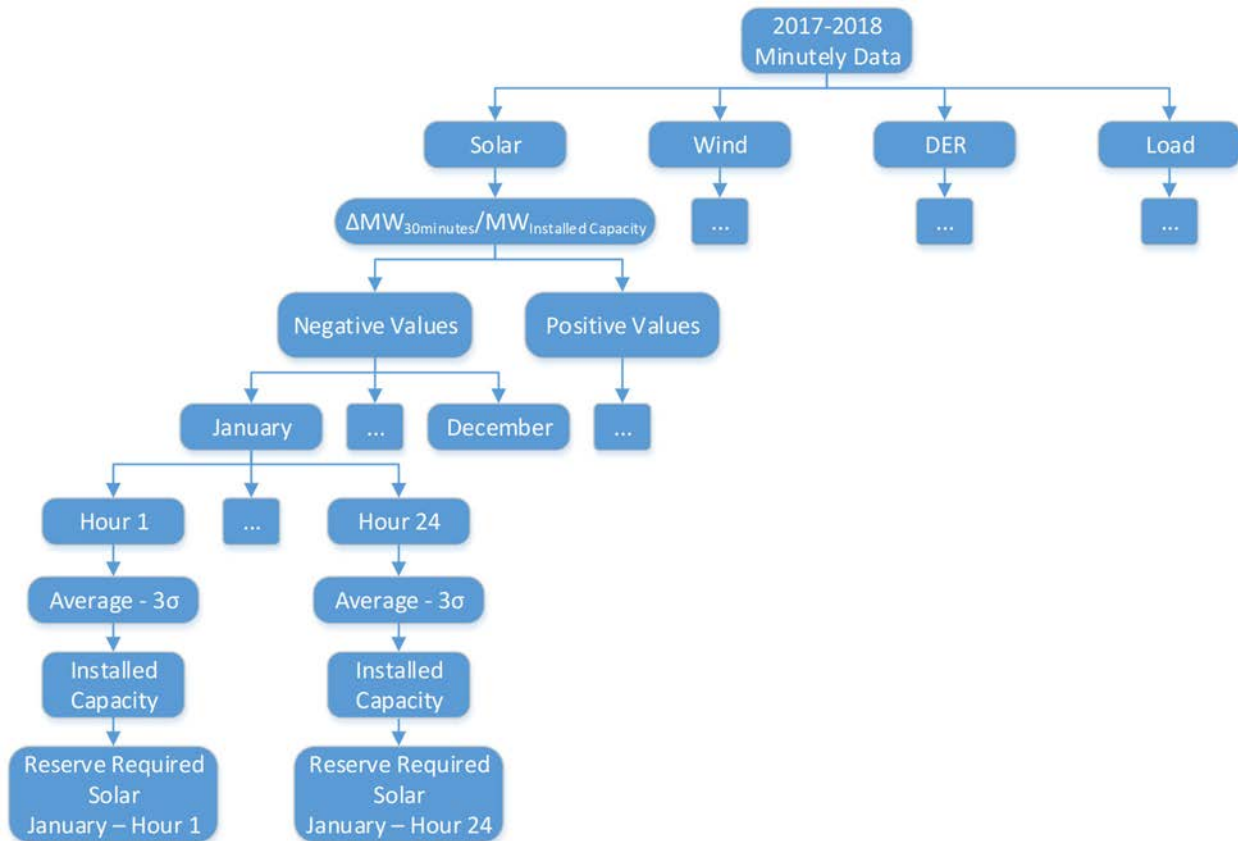


For each category, positive/negative change, and month and hour, the average and standard deviation was determined. For positive changes, the average plus three standard deviation was calculated, and for negative changes, the average minus three standard deviation was



calculated. While ERCOT uses the 95<sup>th</sup> percentile when calculating their reserve requirement, given our islanded system and high renewable penetration, a more stringent requirement was used. These values were then multiplied by the installed capacity or peak load to determine the requirement needed for that category, month, and hour, as shown in Figure D- 5.

Figure D- 5: Data flow from minutely data to reserve requirement for each category/month/hour



The total reserve required for a given month and hour was calculated by summing the requirement in each of the four categories: Aggregated Grid-Scale Solar, Aggregated Grid-Scale Wind, Aggregated DER, and Gross Load.

---

### D.3. ASSUMPTIONS

As shown below in Table D - 1, the installed capacity used to calculate the reserve requirement depends on whether the resource is controllable and whether the resource is paired.





Table D - 1: Resources included and excluded from the calculation of Regulation Up and Regulation Down

	Regulation Calculation		Regulation Provision	
	Included in Regulation Up	Included in Regulation Down	Provides Regulation Up	Provides Regulation Down
Uncontrollable Customer Resources	Yes	Yes	No	No
Controllable Customer Resources	Yes	No	Yes	Yes
Uncontrollable Grid-Scale Resources	Yes	Yes	No	No
Controllable Grid-Scale Resources (Unpaired)	Yes	No	Yes	Yes
Controllable Grid-Scale Resources (Paired)	No	No	Yes	Yes

All controllable resources were not included in the calculation of Down Regulation because it is assumed that our operators would be able to control these resources if an emergency arises. By not including controllable resources in calculating the Down Regulation, this prevents the need to turn on generators solely to provide Down Regulation for these controllable resources. Paired resources were also not included in the calculation of both Up and Down Regulation because it is assumed that the paired energy storage system would be able to provide any regulation needed by the paired resource. All other resources were included in the calculation of Up and Down Regulation.

---

## D.4. RESULTS

### D.4.1. O’AHU RESULTS

Shown below in Table D - 2 and Table D - 3 is a comparison of the Maximum, Average, and Minimum regulation requirement for O’ahu based on the current methodology used in the PSIP and the methodology being proposed. The current methodology used in the PSIP was the GE method.





Table D – 2: Maximum, Average, and Minimum Regulation Up requirement based on the current methodology used in the PSIP and the proposed methodology for the island of O’ahu

Year	Regulation Up (MW)					
	Minimum		Average		Maximum	
	Current Rule	Proposed Rule	Current Rule	Proposed Rule	Current Rule	Proposed Rule
2020	180.00	180.00	263.78	220.80	349.95	362.95
2025	146.00	140.00	310.17	280.41	436.64	612.93
2030	146.22	140.00	333.72	304.76	492.29	683.40
2035	140.00	140.00	357.06	331.67	548.00	758.81
2040	146.38	140.00	402.11	407.81	654.13	988.61
2045	145.61	140.00	516.70	645.77	922.29	1721.38

Table D – 3: Maximum, Average, and Minimum Regulation Down requirement based on the current methodology used in the PSIP and the proposed methodology for the island of O’ahu

Year	Regulation Down (MW)					
	Minimum		Average		Maximum	
	Current Rule	Proposed Rule	Current Rule	Proposed Rule	Current Rule	Proposed Rule
2020	60.00	60.00	60.00	115.87	60.00	236.00
2025	60.00	60.00	60.00	129.75	60.00	277.96
2030	60.00	60.00	60.00	145.65	60.00	326.46
2035	60.00	60.00	60.00	149.33	60.00	357.47
2040	60.00	60.00	60.00	164.33	60.00	408.29
2045	60.00	60.00	60.00	182.76	60.00	465.52

Shown below in Figure D- 6 through Figure D- 9 show a comparison of the regulation requirement between the current method and proposed method for the day, in 2020 and 2025, with the highest average regulation based on the current method.



Figure D- 6: Comparison of Regulation Up requirement between the current methodology and the proposed methodology for June 13, 2020 for the island of O’ahu

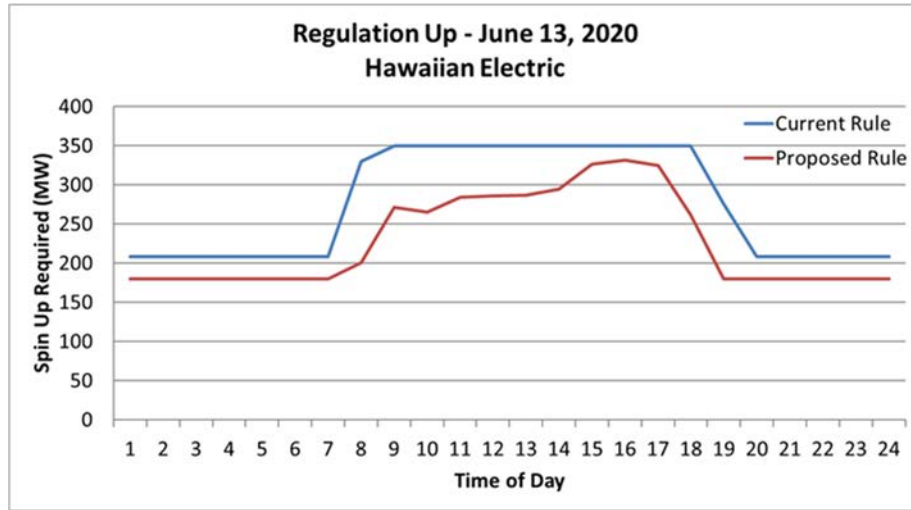


Figure D- 7: Comparison of Regulation Up requirement between the current methodology and the proposed methodology for July 11, 2025 for the island of O’ahu

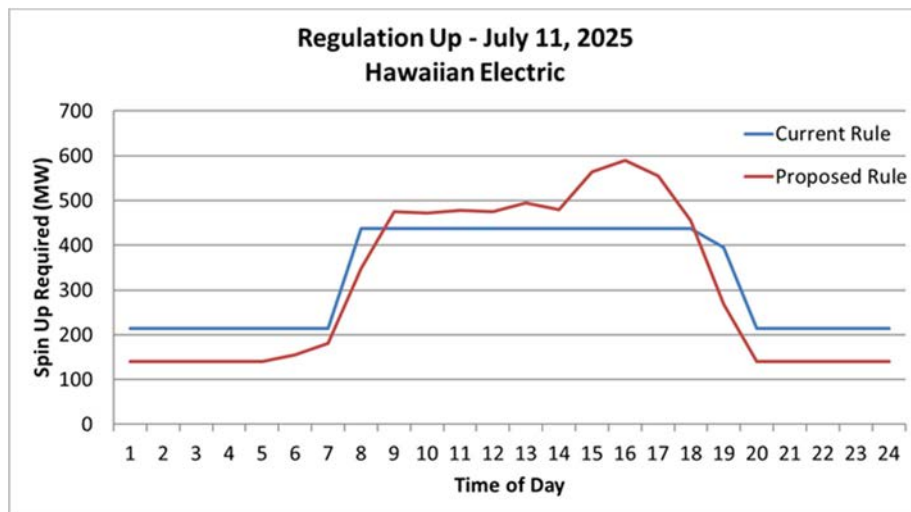


Figure D- 8: Comparison of Regulation Down requirement between the current methodology and the proposed methodology for June 13, 2020 for the island of O’ahu

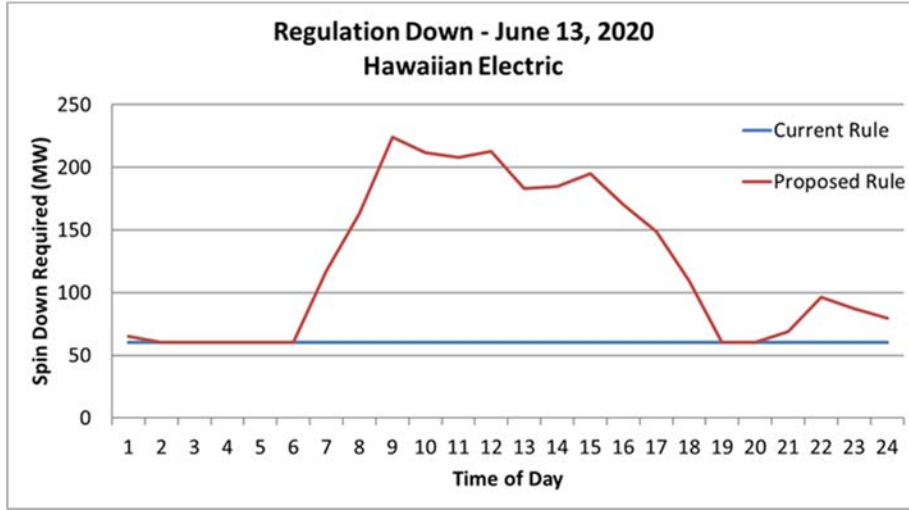
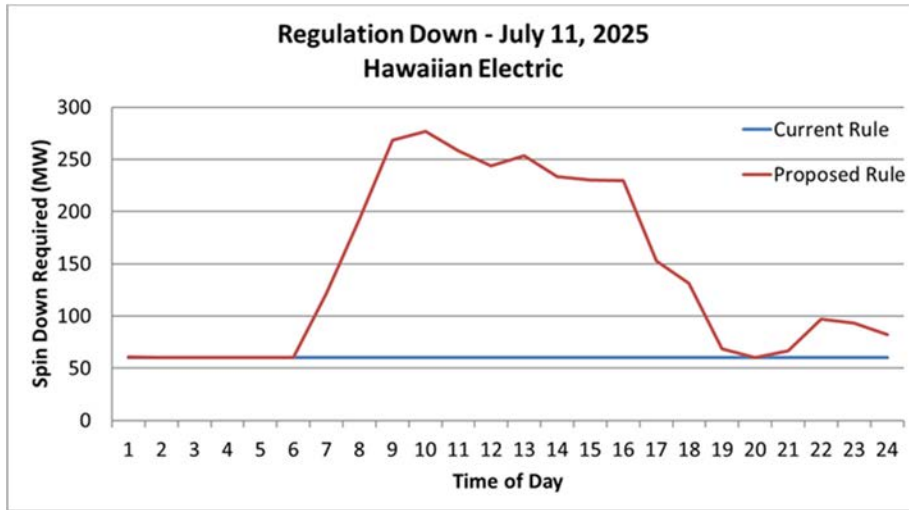


Figure D- 9: Comparison of Regulation Down requirement between the current methodology and the proposed methodology for July 11, 2025 for the island of O’ahu



#### D.4.2. MAUI RESULTS

Shown below in Table D - 4 and Table D - 5 is a comparison of the Maximum, Average, and Minimum regulation requirement for Maui based on the current methodology used in the PSIP and the methodology being proposed. The current methodology used in the PSIP was the EPS method.



Table D – 4: Maximum, Average, and Minimum Regulation Up requirement based on the current methodology used in the PSIP and the proposed methodology for the island of Maui

Regulation Up (MW)						
Year	Minimum		Average		Maximum	
	Current Rule	Proposed Rule	Current Rule	Proposed Rule	Current Rule	Proposed Rule
2020	6.00	6.00	28.50	28.31	57.95	70.71
2025	0.00	6.00	31.65	34.29	69.30	88.61
2030	0.00	6.00	36.84	39.88	82.12	107.08
2035	0.00	6.00	42.00	46.21	94.96	128.26
2040	0.00	6.00	47.21	52.75	107.76	149.80
2045	0.00	6.00	68.70	70.72	166.09	203.14

Table D – 5: Maximum, Average, and Minimum Regulation Down requirement based on the current methodology used in the PSIP and the proposed methodology for the island of Maui

Regulation Down (MW)						
Year	Minimum		Average		Maximum	
	Current Rule	Proposed Rule	Current Rule	Proposed Rule	Current Rule	Proposed Rule
2020	3.00	3.10	3.00	27.90	3.00	64.79
2025	3.00	6.18	3.00	32.84	3.00	74.36
2030	3.00	3.24	3.00	29.51	3.00	79.03
2035	3.00	3.00	3.00	25.44	3.00	84.13
2040	3.00	3.00	3.00	29.20	3.00	96.95
2045	3.00	3.00	3.00	33.21	3.00	110.54

Shown below in Figure D- 10 through Figure D- 13 is a comparison of the regulation requirement between the current method and proposed method for the day, in 2020 and 2025, with the highest average regulation based on the current method.



Figure D- 10: Comparison of Regulation Up requirement between the current methodology and the proposed methodology for June 15, 2020 for the island of Maui

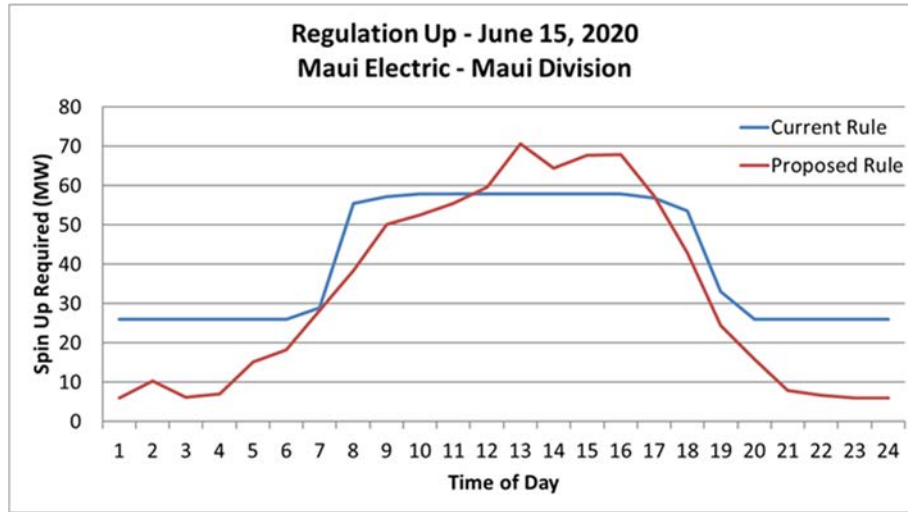


Figure D- 11: Comparison of Regulation Up requirement between the current methodology and the proposed methodology for June 15, 2025 for the island of Maui

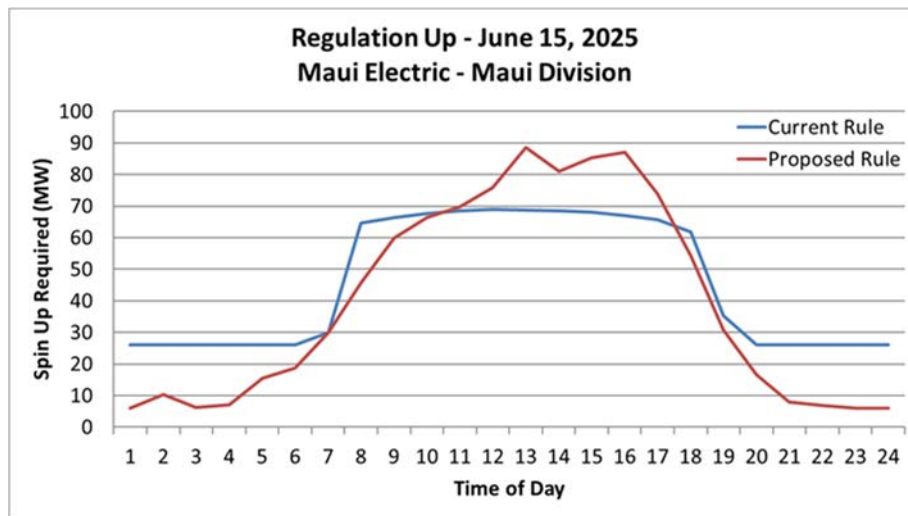


Figure D- 12: Comparison of Regulation Down requirement between the current methodology and the proposed methodology for June 15, 2020 for the island of Maui

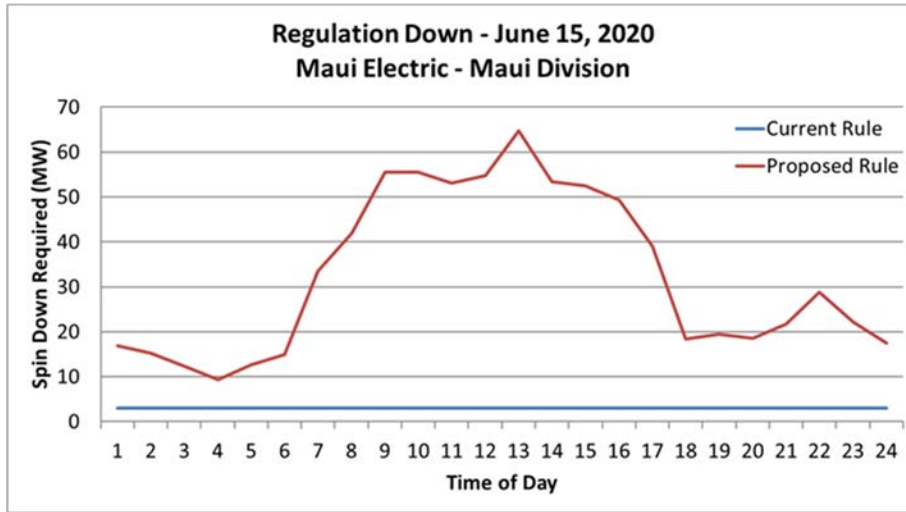
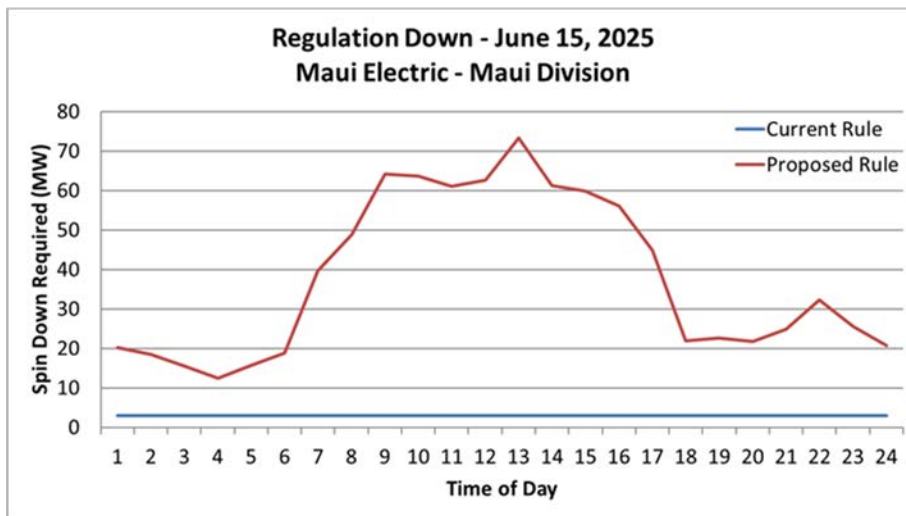


Figure D- 13: Comparison of Regulation Down requirement between the current methodology and the proposed methodology for June 15, 2025 for the island of Maui



### D.4.3. MOLOKA‘I RESULTS

Shown below in Table D - 6 and Table D - 7 is a comparison of the Maximum, Average, and Minimum regulation requirement for Moloka‘i based on the current methodology used in the PSIP and the methodology being proposed. The current methodology used in the PSIP was developed by Ascend Analytics.



Table D – 6: Maximum, Average, and Minimum Regulation Up requirement based on the current methodology used in the PSIP and the proposed methodology for the island of Moloka'i

Regulation Up (MW)						
Year	Minimum		Average		Maximum	
	Current Rule	Proposed Rule	Current Rule	Proposed Rule	Current Rule	Proposed Rule
2020	0.06	0.19	0.40	0.48	0.74	0.89
2025	0.06	0.18	0.48	0.51	0.89	0.86
2030	0.06	0.18	0.47	0.50	0.89	0.84
2035	0.06	0.18	0.48	0.51	0.89	0.86
2040	0.14	0.18	0.52	0.51	0.90	0.87
2045	0.15	0.19	0.53	0.53	0.90	0.90

Table D – 7: Maximum, Average, and Minimum Regulation Down requirement based on the current methodology used in the PSIP and the proposed methodology for the island of Moloka'i

Regulation Down (MW)						
Year	Minimum		Average		Maximum	
	Current Rule	Proposed Rule	Current Rule	Proposed Rule	Current Rule	Proposed Rule
2020	0.70	0.70	0.70	0.70	0.70	0.91
2025	0.70	0.70	0.70	0.70	0.70	0.88
2030	0.70	0.70	0.70	0.70	0.70	0.86
2035	0.70	0.70	0.70	0.70	0.70	0.88
2040	0.70	0.70	0.70	0.70	0.70	0.89
2045	0.70	0.70	0.70	0.70	0.70	0.92

Shown below in Figure D- 14 through Figure D- 17 is a comparison of the regulation requirement between the current method and proposed method for the day, in 2020 and 2025, with the highest average regulation based on the proposed method. The current rule developed by Ascend Analytics is the same for each day of the year. The Regulation Down requirement for most hours was less than the current minimum requirement that is being carried. Only during the early morning did the requirement based on the proposed rule exceed the current minimum requirement, as shown below in Figure D- 16 and Figure D- 17.



Figure D- 14: Comparison of Regulation Up requirement between the current methodology and the proposed methodology for November 15, 2020 for the island of Moloka'i

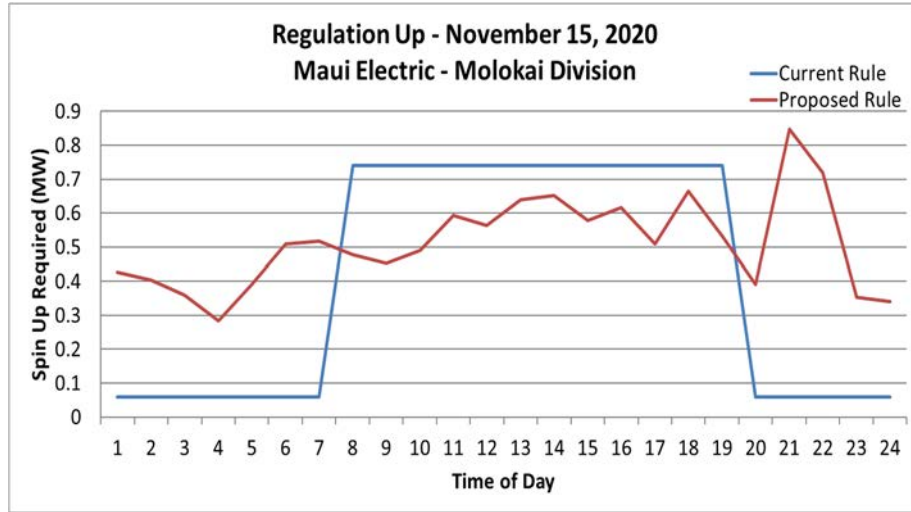


Figure D- 15: Comparison of Regulation Up requirement between the current methodology and the proposed methodology for August 15, 2025 for the island of Moloka'i

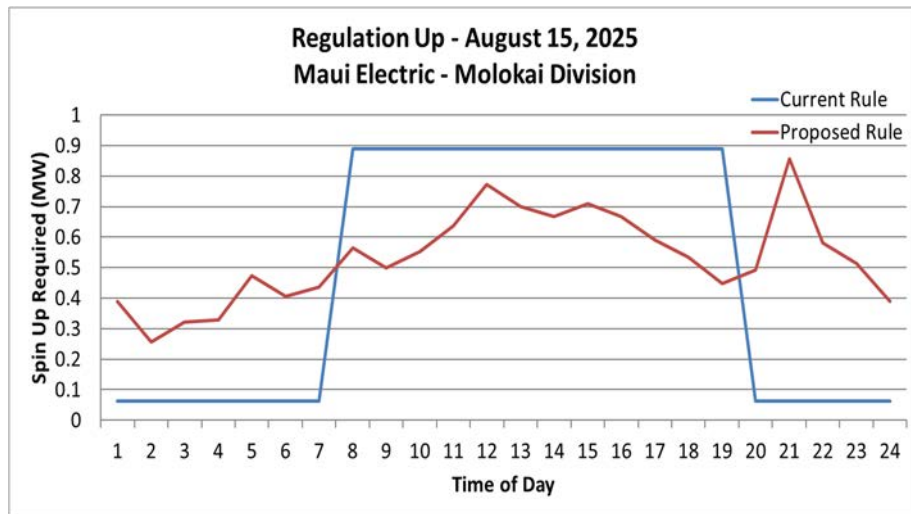




Figure D- 16: Comparison of Regulation Down requirement between the current methodology and the proposed methodology for July 15, 2020 for the island of Moloka'i

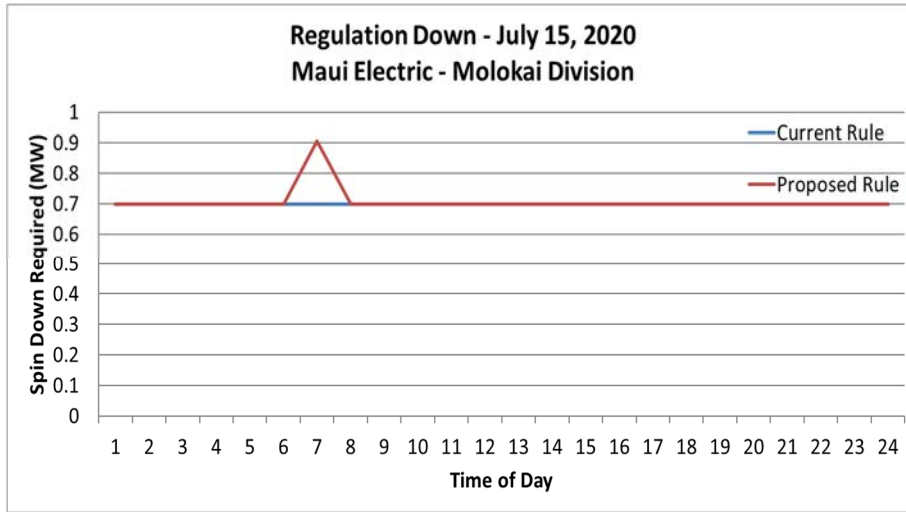
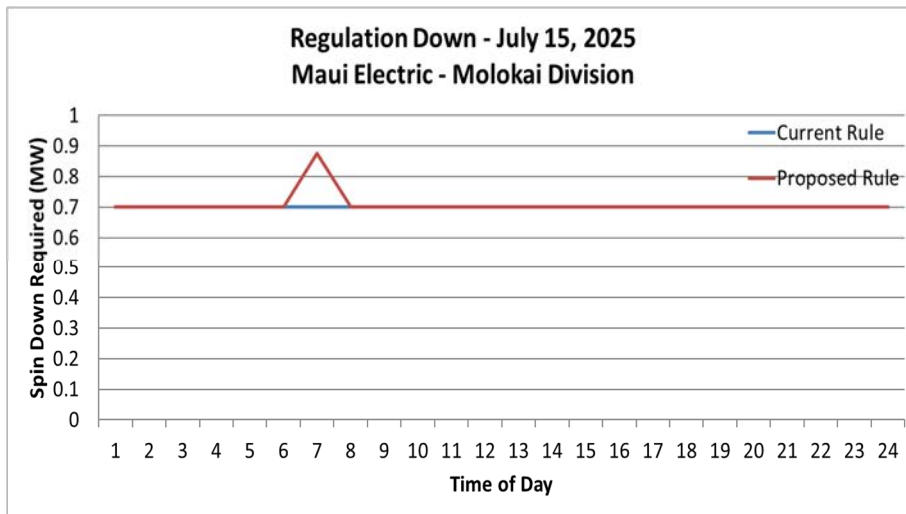


Figure D- 17: Comparison of Regulation Down requirement between the current methodology and the proposed methodology for July 15, 2025 for the island of Moloka'i



#### D.4.4. LĀNA'I RESULTS

Shown below in Table D - 8 and Table D - 9 is a comparison of the Maximum, Average, and Minimum regulation requirement for Lāna'i based on the current methodology used in the PSIP and the methodology being proposed. The current methodology used in the PSIP was developed by Ascend Analytics.



Table D – 8: Maximum, Average, and Minimum Regulation Up requirement based on the current methodology used in the PSIP and the proposed methodology for the island of Lāna‘i

Regulation Up (MW)						
Year	Minimum		Average		Maximum	
	Current Rule	Proposed Rule	Current Rule	Proposed Rule	Current Rule	Proposed Rule
2020	0.06	0.14	0.18	0.39	0.30	0.76
2025	0.06	0.15	0.18	0.40	0.30	0.78
2030	0.06	0.15	0.18	0.41	0.30	0.80
2035	0.06	0.15	0.18	0.43	0.30	0.83
2040	0.14	0.16	0.23	0.44	0.33	0.85
2045	0.15	0.16	0.24	0.45	0.34	0.87

Table D – 9: Maximum, Average, and Minimum Regulation Down requirement based on the current methodology used in the PSIP and the proposed methodology for the island of Lāna‘i

Regulation Down (MW)						
Year	Minimum		Average		Maximum	
	Current Rule	Proposed Rule	Current Rule	Proposed Rule	Current Rule	Proposed Rule
2020	0.50	0.50	0.50	0.51	0.50	0.72
2025	0.50	0.50	0.50	0.51	0.50	0.74
2030	0.50	0.50	0.50	0.51	0.50	0.76
2035	0.50	0.50	0.50	0.51	0.50	0.78
2040	0.50	0.50	0.50	0.52	0.50	0.80
2045	0.50	0.50	0.50	0.52	0.50	0.83

Shown below in Figure D- 18 through Figure D- 21 are a comparison of the regulation requirement between the current method and proposed method for the day, in 2020 and 2025, with the highest average regulation based on the proposed method. The current rule developed by Ascend Analytics is the same for each day of the year. Similar to Molokai, the Regulation Down requirement for most hours was less than the current minimum requirement that is being carried. Only during a few hours does the requirement based on the proposed rule exceed the current minimum requirement, as shown below in Figure D- 20 and Figure D- 21.



Figure D- 18: Comparison of Regulation Up requirement between the current methodology and the proposed methodology for January 15, 2020 for the island of Lānaʻi

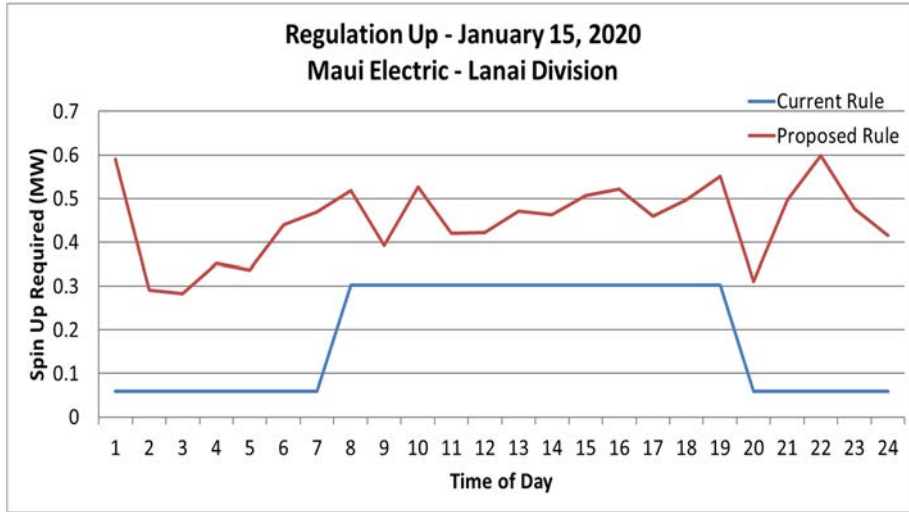


Figure D- 19: Comparison of Regulation Up requirement between the current methodology and the proposed methodology for January 15, 2025 for the island of Lānaʻi

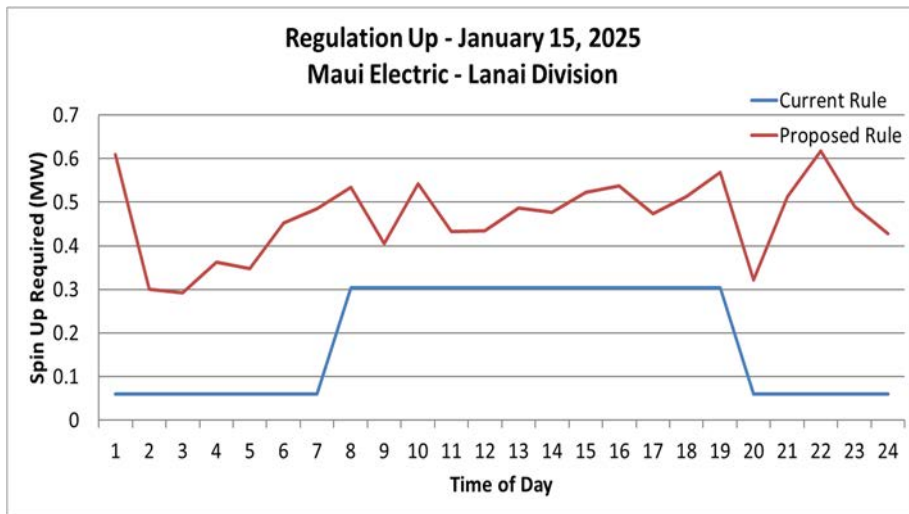


Figure D- 20 Comparison of Regulation Down requirement between the current methodology and the proposed methodology for October 15, 2020 for the island of Lānaʻi

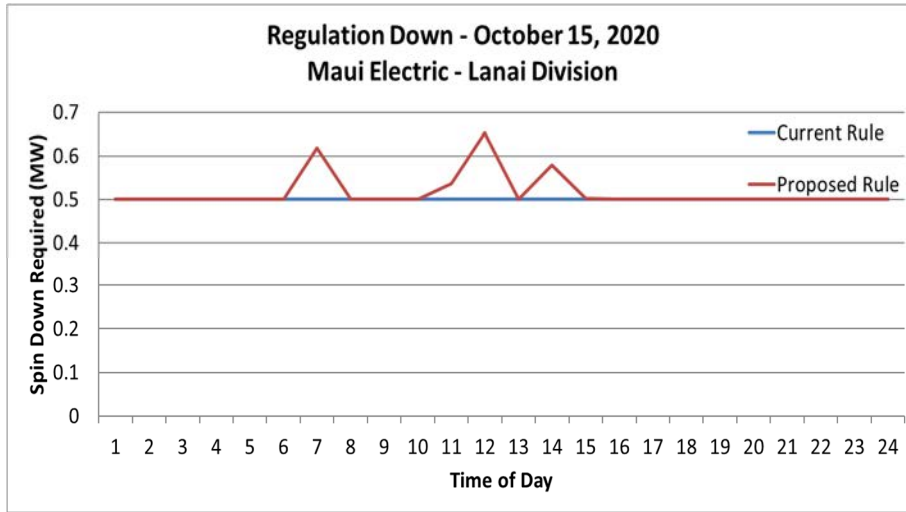
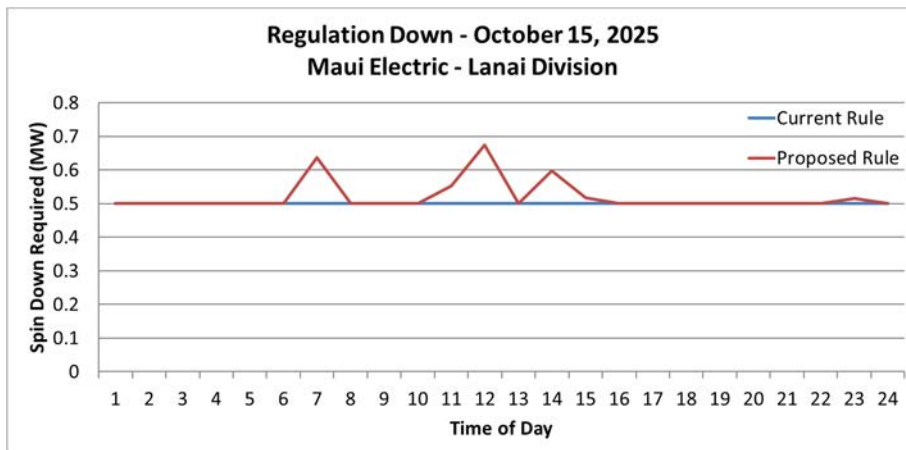


Figure D- 21 Comparison of Regulation Down requirement between the current methodology and the proposed methodology for October 15, 2025 for the island of Lānaʻi



#### D.4.5. HAWAIʻI ISLAND RESULTS

Shown below in Table D - 10 and Table D - 11 is a comparison of the Maximum, Average, and Minimum regulation requirement for Hawaiʻi Island based on the current methodology used in the PSIP and the methodology being proposed. The current methodology used in the PSIP was the EPS method.



Table D - 10: Maximum, Average, and Minimum Regulation Up requirement based on the current methodology used in the PSIP and the proposed methodology for Hawai'i Island

Regulation Up (MW)						
Year	Min		Average		Max	
	Current Rule	Proposed Rule	Current Rule	Proposed Rule	Current Rule	Proposed Rule
2020	6.00	6.00	29.66	20.17	46.83	42.52
2025	6.00	6.00	31.72	25.22	50.79	59.32
2030	6.00	6.00	33.11	29.35	53.14	72.88
2035	6.00	6.00	34.32	33.82	55.23	86.96
2040	6.00	6.00	34.74	38.52	55.76	101.42
2045	6.00	6.00	35.09	43.29	56.08	115.95

Table D - 11: Maximum, Average, and Minimum Regulation Down requirement based on the current methodology used in the PSIP and the proposed methodology for Hawai'i Island

Regulation Down (MW)						
Year	Min		Average		Max	
	Current Rule	Proposed Rule	Current Rule	Proposed Rule	Current Rule	Proposed Rule
2020	9.00	9.00	9.00	17.80	9.00	35.84
2025	9.00	9.00	9.00	17.99	9.00	39.43
2030	9.00	9.00	9.00	17.38	9.00	42.22
2035	9.00	9.00	9.00	19.56	9.00	49.96
2040	9.00	9.00	9.00	22.07	9.00	58.48
2045	9.00	9.00	9.00	24.83	9.00	67.54

Shown below in Figure D - 22 through Figure D- 25 is a comparison of the regulation requirement between the current method and proposed method for the day in 2020 and 2025 with the highest average regulation based on the current method.



Figure D – 22: Comparison of Regulation Up requirement between the current methodology and the proposed methodology for June 14, 2020 for Hawai‘i Island

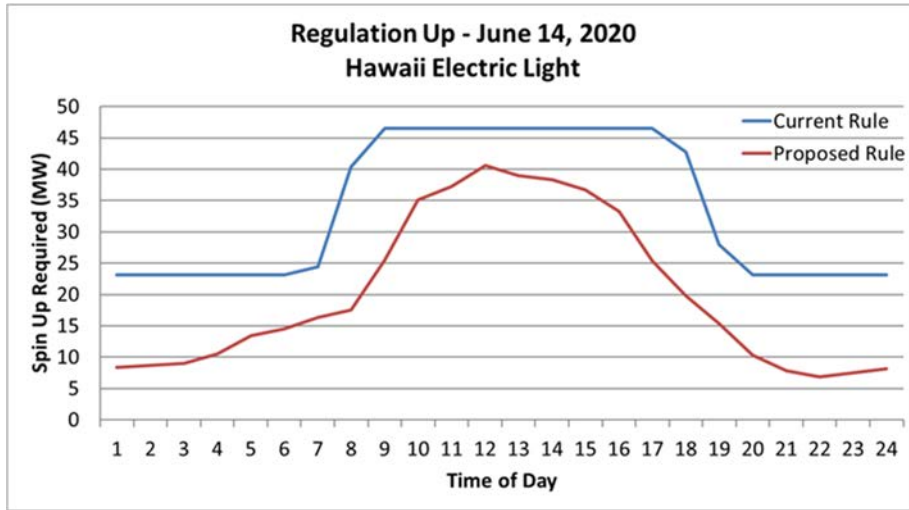


Figure D– 23: Comparison of Regulation Up requirement between the current methodology and the proposed methodology for June 16, 2025 for Hawai‘i Island

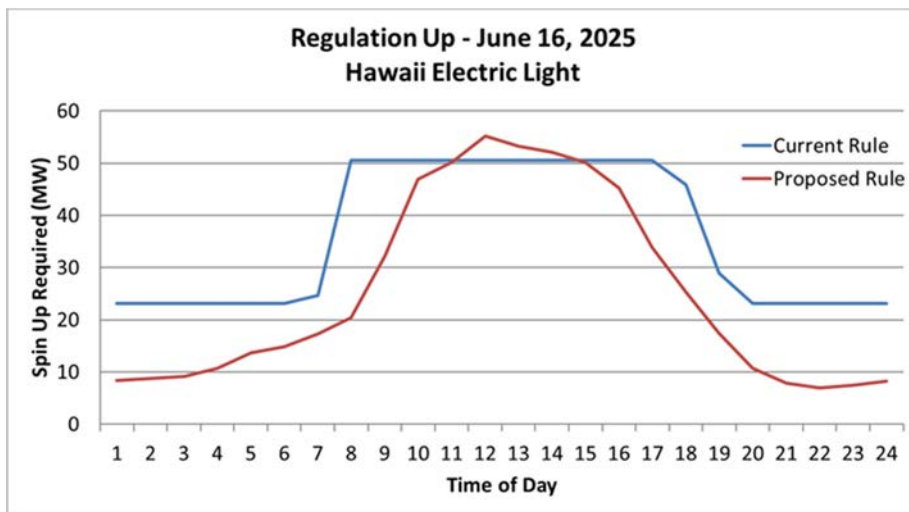


Figure D- 24: Comparison of Regulation Down requirement between the current methodology and the proposed methodology for June 14, 2020 for Hawai'i Island

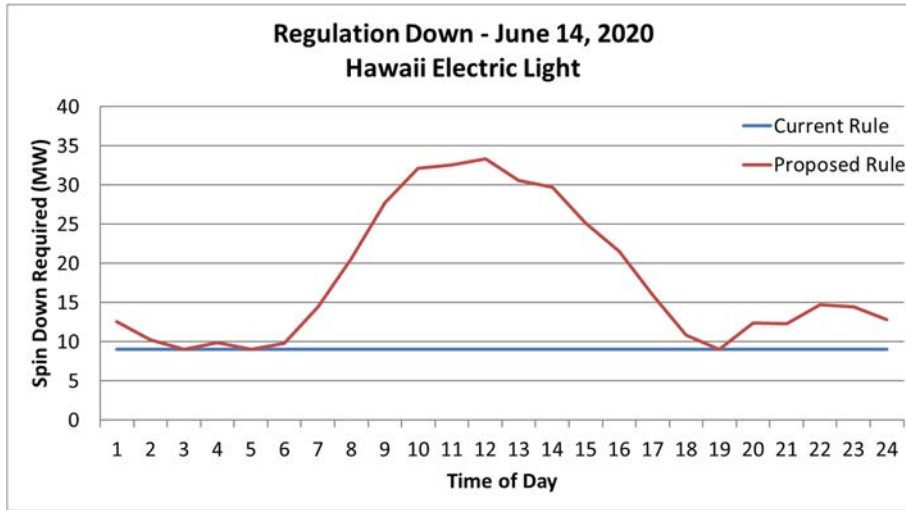
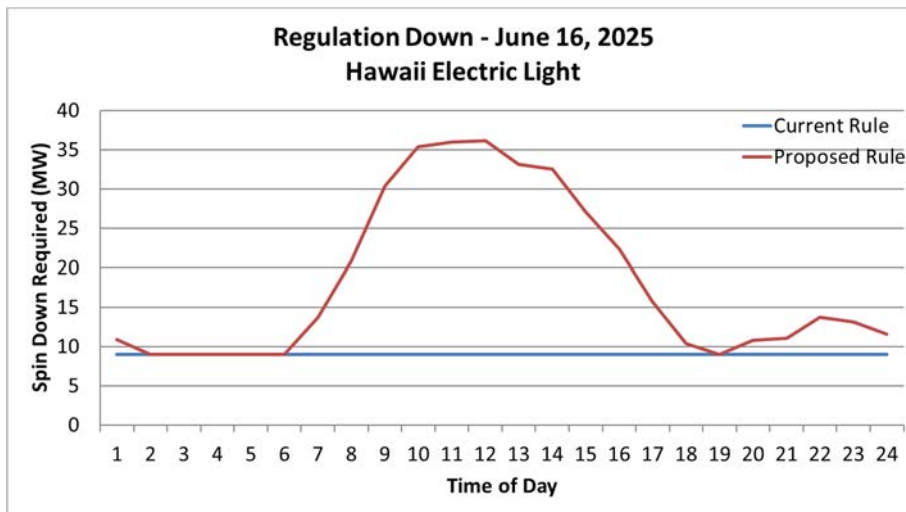


Figure D- 25: Comparison of Regulation Down requirement between the current methodology and the proposed methodology for June 16, 2025 for Hawai'i Island



D.5. DISCUSSION

D.5.1. RESOURCE DIVERSIFICATION

There was an inquiry from the Technical Advisory Panel (“TAP”) members regarding why the requirement was calculated for each resource separately and then aggregated at the end of the calculation versus aggregating all categories at the beginning of the calculation. The TAP



members felt that by aggregating all the resources at the start, any changes in wind and solar may offset each other and result in a lower requirement.

The reason why we chose to calculate the requirement for each resource separately was because if, in the future, an island becomes predominantly reliant on one type of resource over another, we want to be able to accurately reflect that in the reserve requirement. Without calculating the requirement for each resource separately, some of the volatility in one resource may be reduced, or amplified, by the volatility in other resources. For example, if an island becomes more heavily weighted towards Grid-Scale Solar than Grid-Scale Wind, we want to be sure that we can accurately capture the unique reserve requirements associated with Grid-Scale Solar versus Grid-Scale Wind.

### D.5.2. STANDARD DEVIATION

One question raised by the TAP members was why we chose to use three standard deviations when calculating the reserve requirement. To address this question, the requirement for one and two standard deviations was also calculated. A comparison of the Maximum, Average, and Minimum regulation requirement for the different standard deviations are shown below in

- Table D - 12 and Table D - 13 for O’ahu,
- Table D - 14 and Table D - 15 for Maui,
- Table D - 16 and Table D - 17 for Moloka’i,
- Table D - 18 and Table D - 19 for Lāna’i, and
- Table D - 20 and Table D - 21 for Hawai’i Island.

As expected, the requirement increases as the standard deviation increases.

Table D - 12: Impact of Standard Deviation on the Maximum, Average, and Minimum Regulation Up requirement for the island of O’ahu

		O’ahu - Regulation Up (MW)		
		Minimum	Average	Maximum
2020	1 Standard Deviation	180.00	180.07	190.94
	2 Standard Deviation	180.00	194.72	276.95
	3 Standard Deviation	180.00	220.80	362.95
2025	1 Standard Deviation	140.00	181.13	319.12
	<b>2 Standard Deviation</b>	<b>140.00</b>	<b>229.51</b>	<b>466.02</b>
	3 Standard Deviation	140.00	280.41	612.93





Table D – 13: Impact of Standard Deviation on the Maximum, Average, and Minimum Regulation Down requirement for the island of O’ahu

		O’ahu – Regulation Down (MW)		
		Minimum	Average	Maximum
2020	1 Standard Deviation	60.00	74.59	124.15
	2 Standard Deviation	60.00	94.43	178.53
	3 Standard Deviation	60.00	115.87	236.00
2025	1 Standard Deviation	60.00	81.42	149.65
	2 Standard Deviation	60.00	104.87	212.51
	3 Standard Deviation	60.00	129.75	277.96

Table D – 14: Impact of Standard Deviation on the Maximum, Average, and Minimum Regulation Up requirement for the island of Maui

		Maui – Regulation Up (MW)		
		Minimum	Average	Maximum
2020	1 Standard Deviation	6.00	12.82	33.02
	2 Standard Deviation	6.00	20.19	51.87
	3 Standard Deviation	6.00	28.31	70.71
2025	1 Standard Deviation	6.00	15.91	42.62
	2 Standard Deviation	6.00	24.74	65.60
	3 Standard Deviation	6.00	34.29	88.61



Table D – 15: Impact of Standard Deviation on the Maximum, Average, and Minimum Regulation Down requirement for the island of Maui

		Maui – Regulation Down (MW)		
		Minimum	Average	Maximum
2020	1 Standard Deviation	0.00	11.95	31.96
	2 Standard Deviation	0.80	19.92	48.21
	3 Standard Deviation	3.10	27.90	64.79
2025	1 Standard Deviation	3.00	16.01	38.07
	2 Standard Deviation	3.86	24.42	55.92
	3 Standard Deviation	6.18	32.84	74.36

Table D – 16: Impact of Standard Deviation on the Maximum, Average, and Minimum Regulation Up requirement for the island of Moloka'i

		Moloka'i – Regulation Up (MW)		
		Minimum	Average	Maximum
2020	1 Standard Deviation	0.09	0.25	0.45
	2 Standard Deviation	0.14	0.37	0.67
	3 Standard Deviation	0.19	0.48	0.89
2025	1 Standard Deviation	0.09	0.26	0.44
	2 Standard Deviation	0.14	0.38	0.65
	3 Standard Deviation	0.18	0.51	0.86



Table D – 17: Impact of Standard Deviation on the Maximum, Average, and Minimum Regulation Down requirement for the island of Moloka'i

		Moloka'i - Regulation Down (MW)		
		Minimum	Average	Maximum
2020	1 Standard Deviation	0.70	0.70	0.70
	2 Standard Deviation	0.70	0.70	0.70
	3 Standard Deviation	0.70	0.70	0.91
2025	1 Standard Deviation	0.70	0.70	0.70
	2 Standard Deviation	0.70	0.70	0.70
	3 Standard Deviation	0.70	0.70	0.88

Table D – 18: Impact of Standard Deviation on the Maximum, Average, and Minimum Regulation Up requirement for the island of Lāna'i

		Lāna'i - Regulation Up (MW)		
		Minimum	Average	Maximum
2020	1 Standard Deviation	0.07	0.20	0.36
	2 Standard Deviation	0.11	0.30	0.56
	3 Standard Deviation	0.14	0.39	0.76
2025	1 Standard Deviation	0.07	0.21	0.37
	2 Standard Deviation	0.11	0.31	0.57
	3 Standard Deviation	0.15	0.40	0.78



Table D – 19: Impact of Standard Deviation on the Maximum, Average, and Minimum Regulation Down requirement for the island of Lāna‘i

		Lāna‘i – Regulation Down (MW)		
		Minimum	Average	Maximum
2020	1 Standard Deviation	0.50	0.50	0.50
	2 Standard Deviation	0.50	0.50	0.53
	3 Standard Deviation	0.50	0.51	0.72
2025	1 Standard Deviation	0.50	0.50	0.50
	2 Standard Deviation	0.50	0.50	0.55
	3 Standard Deviation	0.50	0.51	0.74

Table D – 20: Impact of Standard Deviation on the Maximum, Average, and Minimum Regulation Up requirement for Hawai‘i Island

		Hawai‘i Island – Regulation Up (MW)		
		Minimum	Average	Maximum
2020	1 Standard Deviation	6.00	11.25	22.21
	2 Standard Deviation	6.00	15.52	32.36
	3 Standard Deviation	6.00	20.17	42.52
2025	1 Standard Deviation	6.00	13.89	31.03
	2 Standard Deviation	6.00	19.36	45.17
	3 Standard Deviation	6.00	25.22	59.32



Table D – 21: Impact of Standard Deviation on the Maximum, Average, and Minimum Regulation Down requirement for Hawai'i Island

		Hawai'i Island - Regulation Down (MW)		
		Minimum	Average	Maximum
2020	1 Standard Deviation	9.00	11.09	18.91
	2 Standard Deviation	9.00	14.18	27.37
	3 Standard Deviation	9.00	17.80	35.84
2025	1 Standard Deviation	9.00	11.49	20.98
	2 Standard Deviation	9.00	14.52	30.20
	3 Standard Deviation	9.00	17.99	39.43

Given the small island systems with high levels of renewable penetration, we decided to use three standard deviations to calculate our reserve requirement.

### D.5.3. TIME INTERVAL

TAP members also questioned the time interval used when calculating the change in renewable generation and load. The time interval was based on feedback from system operators to account for the time it would take to decide to start a unit plus the time needed, after the decision is made, to bring the unit online. Therefore, the time interval used was partially driven by the unique generator characteristics on each island.

Nevertheless, we still examined how the requirement would change when using time intervals of 1-, 10-, 20-, and 30-minutes. A comparison of the Maximum, Average, and Minimum for the different time intervals are shown below in:

- Table D - 23 and Table D - 24 for O'ahu,
- Table D - 25 and Table D - 26 for Maui,
- Table D - 27 and Table D - 28 for Moloka'i,
- Table D - 29 and Table D - 30 for Lāna'i, and
- Table D - 31 and Table D - 32 for Hawai'i Island.

It is important to note that for the 1-minute time interval, it was assumed that the operator would not be able to react fast enough to control these resources in an emergency. As a result, unlike for the longer duration time-intervals, for the 1-minute time-interval, controllable resources were included in the Down Regulation calculation. An update to Table D - 1 for the 1-minute regulation calculation is shown in Table D - 22 below.



Table D – 22: Resources included and excluded from the calculation of Regulation Up and Regulation Down for 1-minute intervals

	Regulation Calculation 1-minute Interval		Regulation Provision 1-minute Interval	
	Included in Regulation Up	Included in Regulation Down	Provides Regulation Up	Provides Regulation Down
Uncontrollable Customer Resources	Yes	Yes	No	No
Controllable Customer Resources	Yes	Yes	Yes	Yes
Uncontrollable Grid-Scale Resources	Yes	Yes	No	No
Controllable Grid-Scale Resources (Unpaired)	Yes	Yes	Yes	Yes
Controllable Grid-Scale Resources (Paired)	No	No	Yes	Yes

Table D – 23: Impact of time interval on the Maximum, Average, and Minimum Regulation Up requirement for the island of O’ahu

		O’ahu - Regulation Up (MW)		
		Minimum	Average	Maximum
2020	1 Minute	6.62	51.63	154.26
	10 Minute	180.00	194.76	266.76
	20 Minute	180.00	208.30	320.29
	30 Minute	180.00	220.80	362.95
2025	1 Minute	13.11	82.49	229.06
	10 Minute	140.00	223.54	431.50
	20 Minute	140.00	254.49	523.23
	30 Minute	140.00	280.41	612.93



Table D – 24: Impact of time interval on the Maximum, Average, and Minimum Regulation Down requirement for the island of O’ahu

		O’ahu – Regulation Down (MW)		
		Minimum	Average	Maximum
2020	1 Minute	6.56	49.37	146.41
	10 Minute	60.00	93.69	189.52
	20 Minute	60.00	104.41	219.65
	30 Minute	60.00	115.87	236.00
2025	1 Minute	13.71	77.31	212.39
	10 Minute	60.00	103.46	222.19
	20 Minute	60.00	116.40	257.97
	30 Minute	60.00	129.75	277.96

Table D – 25: Impact of time interval on the Maximum, Average, and Minimum Regulation Up requirement for the island of Maui

		Maui – Regulation Up (MW)		
		Minimum	Average	Maximum
2020	1 Minute	1.91	10.30	30.16
	10 Minute	6.00	18.51	55.41
	20 Minute	6.00	23.78	65.02
	30 Minute	6.00	28.31	70.71
2025	1 Minute	1.94	12.39	37.23
	10 Minute	6.00	22.99	70.37
	20 Minute	6.00	29.12	82.26
	30 Minute	6.00	34.29	88.61



Table D – 26: Impact of time interval on the Maximum, Average, and Minimum Regulation Down requirement for the island of Maui

		Maui - Regulation Down (MW)		
		Minimum	Average	Maximum
2020	1 Minute	1.89	10.15	30.58
	10 Minute	0.71	17.10	52.52
	20 Minute	2.10	23.30	63.64
	30 Minute	3.10	27.90	64.79
2025	1 Minute	1.92	12.20	37.83
	10 Minute	3.76	21.57	60.92
	20 Minute	5.17	28.04	73.09
	30 Minute	6.18	32.84	74.36

Table D – 27: Impact of time interval on the Maximum, Average, and Minimum Regulation Up requirement for the island of Moloka'i

		Moloka'i - Regulation Up (MW)		
		Minimum	Average	Maximum
2020	1 Minute	0.07	0.14	0.26
	10 Minute	0.14	0.37	0.69
	20 Minute	0.19	0.48	0.89
	30 Minute	0.21	0.56	0.98
2025	1 Minute	0.06	0.15	0.25
	10 Minute	0.14	0.39	0.67
	20 Minute	0.18	0.51	0.86
	30 Minute	0.21	0.58	0.95





Table D – 28: Impact of time interval on the Maximum, Average, and Minimum Regulation Down requirement for the island of Moloka'i

		Moloka'i - Regulation Down (MW)		
		Minimum	Average	Maximum
2020	1 Minute	0.08	0.13	0.23
	10 Minute	0.70	0.70	0.73
	20 Minute	0.70	0.70	0.91
	30 Minute	0.70	0.71	0.92
2025	1 Minute	0.08	0.14	0.23
	10 Minute	0.70	0.70	0.71
	20 Minute	0.70	0.70	0.88
	30 Minute	0.70	0.70	0.89

Table D – 29: Impact of time interval on the Maximum, Average, and Minimum Regulation Up requirement for the island of Lāna'i

		Lāna'i - Regulation Up (MW)		
		Minimum	Average	Maximum
2020	1 Minute	0.07	0.15	0.22
	10 Minute	0.14	0.32	0.56
	20 Minute	0.14	0.39	0.76
	30 Minute	0.11	0.44	0.90
2025	1 Minute	0.08	0.16	0.23
	10 Minute	0.15	0.33	0.58
	20 Minute	0.15	0.40	0.78
	30 Minute	0.11	0.46	0.93



Table D – 30: Impact of time interval on the Maximum, Average, and Minimum Regulation Down requirement for the island of Lānaʻi

		Lānaʻi – Regulation Down (MW)		
		Minimum	Average	Maximum
2020	1 Minute	0.07	0.15	0.23
	10 Minute	0.50	0.50	0.54
	20 Minute	0.50	0.51	0.72
	30 Minute	0.50	0.53	0.92
2025	1 Minute	0.07	0.15	0.23
	10 Minute	0.50	0.50	0.56
	20 Minute	0.50	0.51	0.74
	30 Minute	0.50	0.53	0.95

Table D – 31: Impact of time interval on the Maximum, Average, and Minimum Regulation Up requirement for Hawaiʻi Island

		Hawaiʻi Island – Regulation Up (MW)		
		Minimum	Average	Maximum
2020	1 Minute	1.58	7.21	21.32
	10 Minute	6.00	15.66	35.11
	20 Minute	6.00	20.17	42.52
	30 Minute	6.00	23.68	48.36
2025	1 Minute	1.61	9.35	29.83
	10 Minute	6.00	19.77	49.35
	20 Minute	6.00	25.22	59.32
	30 Minute	6.00	29.46	67.64



Table D – 32: Impact of time interval on the Maximum, Average, and Minimum Regulation Down requirement for Hawai'i Island

		Hawai'i Island - Regulation Down (MW)		
		Minimum	Average	Maximum
2020	1 Minute	1.65	6.94	20.34
	10 Minute	9.00	14.38	29.19
	20 Minute	9.00	17.80	35.84
	30 Minute	9.00	20.89	41.08
2025	1 Minute	1.68	9.01	28.22
	10 Minute	9.00	14.92	32.01
	20 Minute	9.00	17.99	39.43
	30 Minute	9.00	20.91	45.37

To capture both the regulation needed by our operators to bring units online, as well as the regulation needed to manage short-term fluctuations associated with variable renewable generation, it was decided that for O'ahu and Maui, requirements based on both the 1-minute and 30-minute interval would be used. For Hawai'i Island, requirements based on both the 1-minute and 20-minute interval would be used. The 1-minute requirement would ensure that there is enough generation on the system to meet any short-term fluctuations in variable energy, while the 20 to 30-minute requirement would ensure that there is enough reserve for our operators to bring units online if needed.



# Appendix E. Load Build and Load Reduce Criteria

Load reduce is a subset of the energy needs, that can be provided by a generator, storage, or controlled load to reduce system load in the required timeframes and durations in response to a remote dispatch signal. Similarly, load build is a subset of energy, that can be provided by storage or controlled load to increase system load in the required timeframes and durations in response to a remote dispatch signal. The intent of these two services is to encourage more load resources to participate economically in the provision of grid services.

In tandem, load build and load reduce grid needs would identify a potential for energy arbitrage although the capacity for and timing of these needs may not be identical.

## Load Reduce

- Aligned with high marginal cost hours
- Subset of the energy service for resources that can't participate in the regular provision of energy or are constrained on the number of calls for service

## Load Build

- Aligned with high variable renewable generation hours
- Identified by the charging of a standalone storage resource selected by RESOLVE
- Reduce hours of overgeneration or to serve unmet downward regulating reserves

---

## E.1. METHODOLOGY

A service requirement will not be input into the RESOLVE model for this service. Rather, a subset of hours (and their marginal avoided costs) for the energy service will be used to identify the need for load build and load reduce.

A production simulation will be utilized to evaluate changes in marginal energy cost across all hours. The results of the production simulation will be analyzed to identify the amount and timing of the need for the load reduce services by binning high marginal cost hours.

The same production simulation can be used to bin the hours where there is a high availability of variable renewable generation on the system. The need for load build services can be identified where these high available energy hours overlap with the charging of a standalone storage resource selected by RESOLVE. If RESOLVE did not select a standalone storage resource to shift load, then the model decided that the level of curtailment on the system was a lower cost option than installing the storage resource to enable the load build service.



The avoided cost for each grid service will be calculated for 2027-20234, 2040, 2045, and 2050, consistent with the planning horizon used in RESOLVE.



# Appendix F. Transmission Planning Criteria

The transmission planning criteria for O'ahu, Hawai'i Island, and Maui will be used in the identification of transmission needs, including system security. The Transmission Planning Criteria underwent multiple reviews by the Technical Advisory Panel dating back to 2019. The most recent TAP review and feedback that has been incorporated is included in Appendix G.

---

## F.1. O'AHU TRANSMISSION CRITERIA

### F.1.1. PURPOSE

The purpose of these criteria is to establish guidelines for planning the Hawaiian Electric Oahu Transmission System to ensure safe and reliable service to its customers to serve current and future system needs. These criteria also apply to facilities that interconnect to the Oahu Transmission System. The primary objectives of these criteria to maintain reliable Transmission System operation (i.e., continuity of service) include the following:

- Ensure public safety.
- Maintain system stability under a wide range of operating conditions identified in Section 1.8.4.
- Maintain equipment operating limits under a wide range of operating conditions identified in Section 1.8.4.
- Minimize losses where cost effective.
- Preserve the reliability of the existing transmission infrastructure.
- Maintain an acceptable level of impact to customers for contingencies and events as defined within this planning criteria.
- Prevent cascading outages or system failure following credible contingencies and events.

The criteria outlined below are intended to be used as a general guide in planning the Oahu Transmission System, for which transmission needs for reinforcement, enhancements, and mitigations will be determined.

### F.1.2. DEFINITIONS

**Acceptable Damping:** A continuous attenuation of oscillations required to achieve equilibrium over a four-cycle period.



**Cascading:** The uncontrolled successive loss of System Elements triggered by an incident at any location. Cascading results in widespread electric service interruption that cannot be restrained from sequentially spreading beyond an area predetermined by studies. (Source: Glossary of Terms Used in NERC Reliability Standards; Effective Date July 1, 2016)

**Consequential Load Loss:** All load that is no longer served by the Transmission System as a result of Transmission System Facilities being removed from service by a Protection System operation designed to isolate the fault. (Source: Glossary of Terms Used in NERC Reliability Standards; Effective Date January 1, 2015)

**Contingency:** The unexpected failure or outage of a system component, such as a generator, transmission line, circuit breaker, switch or other electrical element. (Source: Glossary of Terms Used in NERC Reliability Standards; February 8, 2005)

**Contingency Reserve:** The provision of capacity deployed by system operator to meet reliability requirements in Section F.1.8.

**Corrective Action Plan:** A list of actions and an associated timetable for implementation to remedy a specific problem. (Source: Glossary of Terms Used in NERC Reliability Standards; February 7, 2006)

**Distributed Energy Resources or DER:** Resources interconnected to the distribution system that produce electricity.

**Droop Response or Primary Frequency Response:** Open-loop proportional control defined as a percentage of turbine speed or system frequency divided by its rated capacity (i.e., turbine or IBR rating). For a 5% droop response, a unit operating at full speed no load or zero output will instantaneously, without any intentional time delays, issue a control signal to export 100% rated capacity for a 5% decrease in turbine speed or system frequency.

**Element or Elements:** Any electrical device with terminals that may be connected to other electrical devices such as a generator, transformer, circuit breaker, bus section, or transmission line. An Element may be comprised of one or more components. (Source: Glossary of Terms Used in NERC Reliability Standards; Effective Date July 1, 2016)

**Equipment Rating:** The rating as defined by the equipment owner that specifies the level of electrical loading or output, usually expressed in megawatts (MW) or Mvar or other appropriate units, that a system, facility, or element can support, produce, or withstand for a finite period. The rating assumes acceptable loss of equipment life or other physical or safety limitations for the equipment involved. (Source: Glossary of Terms Used in NERC Reliability Standards; February 8, 2005)

**Extreme Events:** Less frequent but more severe Contingencies that could result in a cascading effect.



**Facility or Facilities:** A set of electrical equipment that operates as a single bulk electric system Element (for example, a line, a generator, a shunt compensator, transformer, etc.). (Source: Glossary of Terms Used in NERC Reliability Standards; February 7, 2006)

**Fast Frequency Response:** Power injected to (or absorbed from) the grid in response to changes in measured or observed frequency during the arresting phase of a frequency excursion event to improve the frequency nadir or initial rate-of-change of frequency. (Source: NERC Fast Frequency Response Concepts and Bulk Power System Reliability Needs – NERC Inverter-Based Resource Performance Task Force; March 2020)

**Inverter-Based Resource or IBR:** A resource that is asynchronously connected to the sub-transmission or Transmission System through power electronics.

**Long-Term Transmission Planning Horizon:** Transmission planning period that covers years six through ten or beyond when required to accommodate any known longer lead time projects that may take longer than ten years to complete. (Source: Glossary of Terms Used in NERC Reliability Standards; Effective Date January 1, 2015)

**Near-Term Transmission Planning Horizon:** The transmission planning period that covers year one through five. (Source: Glossary of Terms Used in NERC Reliability Standards; January 24, 2011)

**Non-Consequential Load Loss:** Load that is disconnected from the system by the utility to stabilize system frequency or voltage. Non-Consequential Load loss does not include: (1) Consequential Load Loss, (2) the response of voltage sensitive load, or (3) load that is disconnected from the system by end-user equipment.

**Planning Assessment:** Documented evaluation of future Transmission System performance and Corrective Action Plans to remedy identified deficiencies. (Source: Glossary of Terms Used in NERC Reliability Standards; Effective Date January 1, 2015)

**Protection System:** Includes, protective relays which respond to electrical quantities; communications systems necessary for correct operation of protective functions; voltage and current sensing devices providing inputs to protective relays; station dc supply associated with protective functions (including station batteries, battery chargers, and non-battery-based dc supply); and control circuitry associated with protective functions through the trip coil(s) of the circuit breakers or other interrupting devices. (Source: Glossary of Terms Used in NERC Reliability Standards; Effective Date April 1, 2013)

**Short Circuit Ratio or SCR<sup>66</sup>:** Short circuit ratio is defined as the ratio between short circuit apparent power (SCMVA) from a 3LG fault at a given location in the power system to the rating of the Inverter-Based Resource connected to that location. Since the numerator of the SCR

---

<sup>66</sup> NERC Reliability Guidelines, December 2017 - Integrating Inverter Based Resources into Low Short Circuit Ratio Systems





metric is dependent on the specific measurement location, this location is usually stated along with the SCR number.

$$SCR_{POI} = \frac{SCMVA_{POI}}{MW_{IBR}}$$

Where SCMVA is the short circuit MVA level at the POI without the current contribution of the Inverter-Based Resource, and MW IBR is the nominal power rating of the Inverter-Based Resource being connected at the POI.

**Stability:** The ability of an electric system to maintain a state of equilibrium during normal and abnormal conditions or disturbances. (Source: Glossary of Terms Used in NERC Reliability Standards; February 8, 2005)

**System:** A combination of generation, transmission, and distribution components. (Source: Glossary of Terms Used in NERC Reliability Standards; February 8, 2005)

**Termination:** Point at which an Element or Elements connect to a transmission bus or bay.

**Transmission System:** A network of circuits that operate at a nominal voltage of 138 kV. The Transmission System can also include sections of the 46 kV sub-transmission system as defined by these criteria.

**Weak Grid:** A transmission system that has at least one transmission node with a calculated short circuit ratio of less than 3 (i.e., SCR < 3).

### F.1.3. TRANSMISSION SYSTEM DEFINED

For the purpose of these criteria, the Transmission System is defined as all transmission lines, substation equipment, structures, and land utilized for transporting power at 138 kV and above. In addition, the following 138-46 kV transformers, 46 kV buses, and 46 kV circuits are part of the transmission system.

- Honolulu-School No. 1 and No. 2, 46 kV circuits.
- Honolulu-Iwilei No. 1 and No. 2, 46 kV circuits.
- Iwilei-School 46 kV circuit.
- School Street 48/80 MVA, 138-46 kV Transformers A and B.
- Iwilei 48/80 MVA, 138-46 kV Transformers A and B.
- Waiiau 48/80 MVA, 138-46 kV Transformers A and B.
- Honolulu 46 kV Buses A and B.
- Waiiau 46 kV Buses A and B.
- School 46 kV Buses A and B.
- Iwilei 46 kV Buses A and B.



### F.1.3.1. Crossing Points

All transmission line crossing points are to be considered while planning the Transmission System. Following is a list of known crossing points.

- 1) Halawa-Makalapa and Waiau-Koolau 1 & 2 (just outside of Halawa Sub)
- 2) Kahe-Halawa No. 1 and Waiau-Wahiawa (between Structures 21 and 22)
- 3) Kahe-Halawa No. 2 (Structure 85) and Waiau-Wahiawa (Structure 26)
- 4) Waiau-Koolau 2 and Waiau-Wahiawa (between Structures 18 and 19)

The following line crossings are partially protected by an “apron,” which is designed to prevent lines from coming into contact upon conductor failure at their supported ends. This factor should be considered prior to initiating projects related to eliminating these line crossings.

- 5) Waiau-Koolau 1 & 2 and Halawa-Iwilei (just outside of Halawa Sub)
- 6) Waiau-Koolau 1 & 2 and Halawa-School (just outside of Halawa Sub)

### F.1.4. TRANSMISSION PLANNING CRITERIA - THERMAL LIMITS

At a minimum, the O’ahu system shall meet the performance requirements specified by Planning Events Po through P<sub>4</sub> in Section F.1.8. In addition, the O’ahu Transmission System shall meet the following steady-state performance requirements:

- 1) With any generating unit offline for maintenance, all Transmission System Elements will operate within their NORMAL ratings while maintaining voltage levels within their upper or lower limits for any of the following outages:
  - Any other generating unit or IBR that is deemed as a single Contingency equivalent
  - Any synchronous condenser or IBR equivalent
  - Any transmission circuit
  - Any transmission transformer
  - Any transmission bus
- 2) With any generating unit offline for maintenance, all Transmission System Elements will operate within their EMERGENCY ratings while maintaining voltage levels within their upper or lower limits for any multiple transmission circuit outages caused by a line down at a crossing point.
- 3) With any generating unit offline for maintenance, and any transmission line out of service for maintenance, all Transmission System Elements will operate within their EMERGENCY ratings while maintaining voltage levels within their upper or lower limits for any of the following outages:
  - Any other generating unit or IBR equivalent
  - Any synchronous condenser or IBR equivalent



- Any other transmission circuit
- Any multiple transmission circuit outage caused by a line down at a crossing point
- Any transmission transformer
- Any transmission bus

The purpose of this criterion is to ensure the system will remain stable but all loads may not continue to be served. These conditions must be met without operator intervention.

- 4) Any generating station must be able to export real and reactive power equal to the sum of the individual generating unit's NORMAL capability ratings in MW at 100 percent of rated generator field current /power factor with no Transmission System Element loading exceeding its EMERGENCY rating while maintaining voltage levels within their upper or lower limits for any of the following outages:
- Any transmission circuit
  - Any multiple transmission circuit outage caused by a line down at a crossing point
  - Any transmission transformer
  - Any transmission bus

Additionally, for any transmission Element outage, the aggregate generating capacity on any remaining radial transmission circuit will not exceed the maximum single-point failure for the system.

- 5) With the Transmission System intact, the failure of any single transmission Element, coupled with a 138 kV breaker failure while attempting to clear the initial failure, will not result in the loss of:
- More than one generator or IBR Termination
  - More than one sub-transmission transformer Termination
  - More than one "source" circuit to a transmission station Termination
- 6) With two 138 kV transmission circuits on common steel poles taken out of service at the same time for maintenance, all Transmission System Elements will operate within their NORMAL ratings while maintaining voltage levels within their upper or lower limits. This is a maintenance requirement based on present maintenance practices.

The 138 kV system is the backbone of the O'ahu electrical system. Excessive segmentation of a 138 kV transmission line can result in increasingly complex protection coordination schemes, greater susceptibility to mis-operation of relays, maintenance and operational issues, and excessive curtailment of resources for certain transmission line contingencies. The total generation on any transmission line must be limited to the single-point failure capacity of the system. Generating Facilities should interconnect to an existing substation if practical or interconnect to multiple transmission lines through a new standard transmission substation.



### F.1.5. LOADING LIMITS

Conductor loading limits are based on the Overhead and Underground Engineering Standards or by ampacity calculations performed by Engineering. Operational planning mitigations that utilize operator interventions within the duration of allowed Equipment Ratings are not governed by this transmission planning criteria.

#### F.1.5.1. Power Transformer Loading Limits

Loading limits of transmission power transformers shall be as follows:

- 1) The normal loading limit of a transmission power transformer shall be its zero percent loss-of-life kVA capability.
- 2) The emergency loading limit of a transmission power transformer shall be its one percent loss-of-life kVA capability.
- 3) The extreme emergency loading limit of a transmission power transformer shall be 200 percent of its maximum nameplate rating.

Loading limits shall be determined in accordance with the latest edition of C-57.92, ANSI Guide for Loading Mineral - Oil - Immersed Power Transformers Up to and Including 100 MVA with 55°C or 65°C Winding Rise.

#### F.1.5.2. Current Carrying Capacity

##### Overhead

Conductors for overhead transmission lines shall be considered to have current carrying capacity in accordance with Engineering Standard 1-2038, "Current Carrying Capacity Outdoor Bare Conductor." A conductor bundle with identical conductors shall have the rating of a single conductor multiplied by the number of conductors per phase in the bundle.

##### Underground

The 46 kV underground circuit ampacities are:



Table F – 1: 46 kV Underground Ampacities

	NORMAL	EMERGENCY "A"	EMERGENCY "B"
Honolulu-Iwilei #1	320 Amps	523 Amps	536 Amps
Honolulu-Iwilei #2	320 Amps	526 Amps	563 Amps
Honolulu-School #1	300 Amps	532 Amps	534 Amps
Honolulu-School #2	300 Amps	553 Amps	551 Amps
Iwilei-School	250 Amps	503 Amps	403 Amps*

\*Assume all circuits in the same duct bank of Iwilei-School circuit are energized.

The Emergency "A" rating is based on one Honolulu-Iwilei circuit out of service. Emergency "B" rating is based on one Honolulu-School circuit out of service.

### Open Bus

Open buses shall be considered to have current carrying capacity in accordance with Engineering Standard, 1-2039, "Current Carrying Capacity- Outdoor Open Bus."

### Power Transformer Equipment

Transmission power transformer connections, switches, protective relays, and current transformers shall be designed to allow the power transformer to carry 200 percent of maximum nameplate rating under extreme emergency conditions in accordance with the latest edition of C-57.92, ANSI Guide for Loading Mineral - Oil - Immersed Power Transformers Up to and Including 100 MVA with 55°C or 65°C Winding Rise. (The relay settings associated with this type of transformer shall allow the transformer to carry 200 percent of maximum nameplate rating.)

### Substation Equipment

Switches, disconnects, circuit breakers, and associated equipment shall be considered to have a current carrying capacity equivalent to their respective nameplate current rating.



### F.1.5.3. Generator MVAR Loading Limits

For planning purposes, the reactive capability of a given machine will be determined using the manufacturer's machine capability curve and normal MW at rated power factor for generating units. At no time will the system be planned with any generator or IBR exceeding its rating as determined by its capability curve corresponding to the appropriate ambient temperature suitable for the O'ahu system.

### F.1.6. VOLTAGE LEVELS

Transmission voltage levels shall be kept within the prescribed limits for any condition for which the Transmission System is planned. These limits apply after automatic corrective action has been taken by LTC and/or switched capacitors.

The maximum voltage limits are based on *Standards for Electric Utility Service in the State of Hawaii* (General Order No.7).

- 1) 138 kV System. For any system operating condition, the voltage at any 138 kV bus shall not exceed 145 kV.
- 2) 46 kV System. For any system operating condition, the voltage on the 46 kV system shall not exceed 48 kV.

The minimum voltage limits are based upon maintaining customer voltages in accordance with *Standards for Electric Utility Service in the State of Hawaii* (General Order No.7). To accomplish this, the 46 kV bus voltages at the transmission substations must be maintained within the limits that are used to plan the sub-transmission system.

- 1) 138 kV System. The minimum allowable voltage on any 138 kV bus is 126.5 kV for any operating condition for which the transmission system is planned.
- 2) 46 kV System. The minimum allowable voltage on any 46 kV bus is 45 kV for any operating condition for which the system is planned.

The system's short-circuit current requirements and resources should be considered when evaluating near-term voltage and MVAR mitigation alternatives.

### F.1.7. SYSTEM STABILITY

Displacement of synchronous generation has a direct impact on dynamic and transient stability. In addition to traditional analyses, new planning metrics and analysis are required to maintain Stability under plausible operating conditions. If the conditions for Weak Grid are met, further analysis may be required in appropriate software modeling platform to fully investigate any Stability concerns.



### F.1.7.1. Steady State Voltage

The power-voltage (PV) and reactive power-voltage (QV) analysis shall be performed to determine the steady-state voltage stability of critical load buses.

Figure F- 1: Typical PV Curve

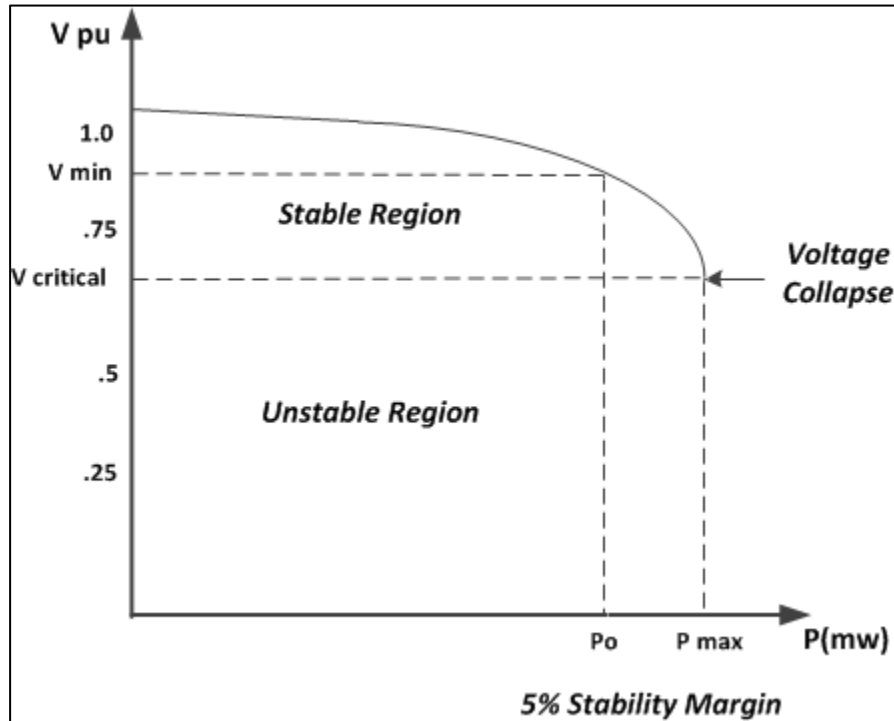


Figure F- 1 shows a typical PV curve that depicts the thermal limit of the transmission system. To ensure voltage stability, a 5% margin from P<sub>0</sub> to P max, identified as P<sub>0</sub>, shall be maintained under planning events described in Section F.1.8. In addition, the intersection of the QV curve with the x-axis shall occur above the minimum allowable voltage level, and the reactive power margin, represented by the value at the minimum point of the QV curve, shall be greater than the size of a nearby capacitor bank or reactive power device.

### F.1.7.2. Weak Grid Assessment

Weak power systems are more susceptible to voltage transients and can be exacerbated by control instabilities. Short circuit ratio (SCR) is the most basic metric to assess the relative strength of an electrical system for a specific area when evaluating performance of a specific

IBR<sup>67</sup>. For system planning purposes, a more appropriate quantity is the weighted short circuit ratio (WSCR)<sup>68</sup>, defined by:

$$WSCR = \frac{\sum_i^N SCMVA_i * P_{RMW_i}}{(\sum_i^N P_{RMW_i})^2}$$

Where  $SCMVA_i$  is the short circuit capacity at bus  $i$  and  $P_{RMW_i}$  is the MW rating of the IBR;  $N$  is the number of total IBR fully interacting with each other and  $i$  is the IBR index. The WSCR takes into account the aggregate IBR of the system to ensure the system has sufficient short circuit current for transient voltage stability. There is currently no industry standard for WSCR of a transmission system.

## Control Stability

Control stability refers to the behavior of grid-connected IBR like wind and solar PV plants to operate in a stable manner for both small disturbances and large disturbances on the grid over a wide range of operating conditions and disturbances. Unstable behavior can result in oscillatory behavior, extreme overshoots in voltage or current, and/or a failure to ride-through a disturbance. The stability of equipment controls is impacted by many factors, including equipment tuning, operating conditions, grid strength, disturbance types, and the electrical proximity to other IBR or synchronous machines on the grid, among others.

As more IBR with complex control system connect to the system, it is important to assess the control stability of these resources to assess the robustness of controls to the range of expected operating conditions over the planning horizon. This will be done through a combination of screening, scenario modeling, and testing/demonstration of performance. As such, supplying accurate and sufficiently detailed models of equipment and functional descriptions of equipment control and protection schemes is necessary well in advance of interconnection. Equipment performance will be evaluated for combinations of:

- Full and partial power operating conditions, high and low voltages (within continuous limits)
- Symmetric and asymmetric fault disturbances (with reclosing), line switching disturbances, loss of generation and load disturbances
- Low grid strength conditions

The system shall maintain operating equilibrium with acceptable damping ratio of 3% for all reasonable combinations of planned outages and system contingencies defined in Section 8.4.

<sup>67</sup> NERC Reliability Guideline – Integrating Variable Energy Resources into Weak Power Systems

<sup>68</sup> Electranix, System Strength Assessment of the Panhandle System, Electric Reliability Council of Texas, 2016





Power oscillations exhibit an acceptable damping ratio of 3% when the oscillation magnitude decreases by 17% over the first period of oscillation, or by 53% over four periods of oscillations.

### F.1.7.3. Rotor Angle Stability Criteria

Rotor angle stability simulations involve the evaluation of critical clearing times ("CCT") for close-in faults to generating stations, generating units, and transmission lines. Generator rotor angle deviation with respect to a "distant" generator shall be less than 180 degrees to prevent generator pole-slipping and in addition to avoiding loss of synchronism. Dynamic performance shall exhibit acceptable damping to ensure rotor angle stability. Pole-slipping could impose mechanical stresses on the generator shaft and could result in catastrophic failure of the unit.

### Critical Clearing Times

The Transmission Planning Department performs Stability simulations using the standard fault clearing times for breakers provided by the System Protection Department. If a fault event results in a planning criteria violation, the Transmission Planning Department shall determine the CCT for that event and will provide it to the System Protection Department for its review and feedback. If the CCT cannot be achieved by the existing protective devices, Transmission Planning Department will work with System Protection Department to develop appropriate mitigation measures. Such mitigation measures may include but not limited to the system protection upgrade, generator size or power export reduction, application of synchronous condenser or adjustments to resource commitment as applicable.

### F.1.7.4. Frequency Stability

Frequency stability is determined by 1) the amount of inertia on the system; 2) the amount and response characteristics of fast-frequency and primary frequency response reserves on the system; and 3) the magnitude of the generation Contingency. The system shall carry sufficient, fast and timely delivered frequency response (including some combination of rotating machine inertia, frequency response reserves, and inverter-based frequency response capabilities) to mitigate credible contingencies, including expected aggregate loss of distributed energy resources in response to the Contingency events in Table F - 3, with appropriate Non-Consequential Load Loss criteria defined in F.1.8. In order to meet these criteria, mitigation measures may require establishing minimum inertia requirement for a generation loss event.



### F.1.7.5. Planning Criteria for Stability

Stability of an electric power system is the attribute of the system to regain a state of operating equilibrium after being subjected to disrupting forces (Contingency events), such that the majority of the system remains intact. Generating units and transmission Elements must remain online and in synchronism with the system to prevent an island-wide blackout. Therefore, the Transmission System shall be tested by simulating frequent Contingency events and reasonable cascading Contingency events that may occur on the system to ensure operating equilibrium is restored.

- 1) For the more frequent types of contingencies listed below, not more than one generating unit can disconnect from the system, all remaining generating units must remain connected and synchronized to the system, all remaining generating units must participate towards beneficial system response, no circuits should trip on stability swings, transient voltage stability must be maintained, and no Non-Consequential Load should take place.
  - Normally cleared, three-phase faults on transmission lines with automatic reclosing as applicable to the circuit being analyzed.
  - Delayed clearing of three-phase faults due to failure of the pilot relay on circuits that have one pilot scheme, and one step-distance scheme for backup to the pilot scheme. Dual-pilot relay schemes require independent communication technologies (e.g., both microwave and fiber-optic cable) to mitigate failure of single-pilot relay schemes. Analysis shall be performed for the simulation of the longest delayed clearing time scenario.
  - Delayed clearing of single line-to-ground faults due to failure of a circuit breaker to open.
  - Normally cleared simultaneous single line-to-ground faults on both circuits that share a common tower (on different phase of each circuit).
  - Exceptions include small units (e.g., internal combustion engines) that share a common generator step-up transformer and combined-cycle units. Other exceptions will be considered on a case-by-case basis.
- 2) For the less frequent contingencies listed below, Non-Consequential Load Loss or generator tripping may be required to prevent equipment damage and maintain Stability.
  - Sudden loss of all transmission lines emanating from a power plant switching station.
  - Sudden loss of all transmission lines in a common right-of-way.
  - Sudden loss of any combined cycle units or any two synchronous generating units (synchronous, asynchronous, or both), including any aggregate loss of DER.
  - Sudden loss of any combination of two transmission Elements.
  - Cascading loss of generation
- 3) Extreme Events—For Extreme Events system preservation shall be tested. An objective of the planning process should be to minimize the likelihood and magnitude of Non-Consequential Load Loss following Contingency events. If any Extreme Events result in an island-wide blackout, mitigation measures shall be formulated and analyzed to see if a



reasonable solution can be implemented. Examples of Extreme Events include but not limited to:

- A three-phase fault on generator, transmission circuit, transformer or bus section with stuck breaker resulting in delayed fault clearing
- A three-phase fault on generator, transmission circuit, transformer, or bus section with failure of a non-redundant component of a Protection System resulting in delayed fault clearing
- Three phase internal breaker fault
- Other events based upon operating experience, such as consideration of initiating events that experience suggests may result in wide area disturbances.

## F.1.8. TRANSMISSION PLANNING ASSESSMENT

A Planning Assessment of the Transmission System must be performed on an annual basis to ensure compliance with these criteria for the Near-Term Planning Horizon and Long-Term Planning Horizons. This Planning Assessment must use current models to analyze steady-state, dynamic, and transient system stability to ensure compliance with these criteria. Updated assumptions, forecasts, and study results shall be summarized and documented in a report.

### F.1.8.1. Near-Term Transmission Planning Horizon

The Near-Term Transmission Planning Horizon should assess a five-year period and evaluate year one, year five, and any other year in between that has a significant system change, e.g., the planned addition or deactivation of a generating unit, the addition of a transmission line, etc. As a minimum, the study shall assess system performance for the following operating periods and conditions:

- Day minimum load (high DER, low gross load)
- Day peak load (low DER, high gross load)
- Evening peak load
- Night minimum load

Base cases may include consideration of each major unit outage period. Sensitivity cases may include consideration of system conditions and operating periods beyond the conditions listed above.

For each of these periods, only the applicable Stability analysis and system events shall be performed. Additional sensitivity cases and/or analyses should be performed on an as-needed basis to ensure system performance meets the Stability criteria specified in Section F.1.7, and may be informed by identified operational constraints.



The Planning Assessment should periodically analyze cascading Contingency events to ensure preservation of the system for plausible planning events. As a minimum, the system shall meet performance requirements of Planning Events P5 through P7 from Table F - 3.

### F.1.8.2. Long-Term Transmission Planning Horizon

The Long-Term Transmission Planning Horizon should be performed in conjunction with the Integrated Grid Planning process. Evaluation years will be dictated by the proposed resource plans. As a minimum, the study shall assess system performance for the following operating periods and conditions:

- Day minimum load (high DER, low gross load)
- Day peak load (low DER, high gross load)
- Evening peak load
- Night minimum load

For each of these periods, only the applicable Stability analysis and system events shall be performed. Models of future generating units will not be readily available; therefore, discretion should be used in: 1) developing the scope of work and sensitivity cases for this Planning Assessment, and 2) interpreting results of these analyses.

### F.1.8.3. Past Studies

Past studies may be used to support the Planning Assessment if they meet the following requirements:

For steady state, short circuit, or Stability analysis:

- The study must contain a technical rationale that can be provided to demonstrate that the results of an older study are still valid, or
- No material changes have occurred to the system represented in the study. Documentation to support the technical rationale for determining material changes must be included.

### F.1.8.4. Planning Events

As a minimum, the Stability criteria in Section F.1.7 ensures that the transmission system meets or exceeds the performance requirements of Planning Events P1 through P4 in Table F - 3. A periodic assessment of the under-frequency load shed scheme should be performed to



ensure that the system meets the minimum requirements of Planning Events P5 through P7 in Table F - 3.



Table F – 2: Steady State and Stability Performance Planning Events

<p>Steady State &amp; Stability:</p> <ol style="list-style-type: none"> <li>1. The system must remain stable. Cascading and uncontrolled islanding shall not occur.</li> <li>2. Consequential Load Loss as well as generation loss is acceptable as a consequence of any event excluding P0.</li> <li>3. Simulate the removal of all elements that Protection Systems and other controls are expected to automatically disconnect for each event.</li> <li>4. Simulate normal clearing unless otherwise specified.</li> <li>5. Planned system adjustments such as transmission configuration changes and re-dispatch of generation are allowed if such adjustments are executable within the time duration applicable to the Equipment Rating.</li> <li>6. Phase angle separation for line Contingency shall not preclude automatic reclosing unless system adjustments can be performed within fifteen minutes.</li> </ol> <p>Steady State Only:</p> <ol style="list-style-type: none"> <li>7. Applicable Equipment Rating must not be exceeded.</li> <li>8. System steady state voltages and post-Contingency voltage deviations must be within acceptable limits as established by this Planning Criteria.</li> <li>9. Planning event P0 is applicable to steady state only.</li> </ol>
--

Table F – 3: Categories of Contingency Events

Category	Initial Condition	Event	Fault(s) Type	Non- Consequential Load Loss Allowed
P0 No Contingency	Normal system	None	N/A	None
P1 Single Contingency	Normal system	Loss of one of the following: <ol style="list-style-type: none"> <li>1. Generator</li> <li>2. Transmission Circuits</li> <li>3. Transformer<sup>2</sup></li> <li>4. Shunt Device-Ancillary Service Device<sup>3</sup></li> </ol>	3∅	None
		5. Generator – no fault	N/A	
P2 Single Contingency	Normal system	<ol style="list-style-type: none"> <li>1. Bus Section fault</li> <li>2. Internal Breaker Fault<sup>4</sup> (Transmission line breaker)</li> </ol>	3∅	None



Category	Initial Condition	Event	Fault(s) Type	Non- Consequential Load Loss Allowed
P3 Single Contingency	Loss of generator unit followed by system adjustments (e.g., corrective action and re-dispatch)	Loss of one of the following: 1. Generator 2. Transmission Circuits 3. Transformer <sup>2</sup> 4. Shunt Device/ Ancillary Service Device <sup>3</sup>	3∅	None
P4 Multiple Contingency (Fault plus stuck breaker)	Normal system	Loss of multiple elements caused by a stuck breaker <sup>5</sup> (non-Bus-tie Breaker) attempting to clear a fault on one of the following: 1. Generator 2. Transmission Circuits 3. Transformer <sup>2</sup> 4. Shunt Device <sup>3</sup> 5. Bus Section	SLG	None
		6. Loss of multiple elements caused by a stuck breaker <sup>5</sup> (Bus-tie Breaker) attempting to clear a fault on the associated bus	SLG	None
P5 Multiple Contingency (Fault plus non-redundant component of a Protection System failure to operate)	Normal system	Delayed fault clearing due to the failure of a non-redundant component of a Protection System protecting the faulted element to operate as designed, for one of the following: 1. Generator 2. Transmission Circuits 3. Transformer <sup>2</sup> 4. Shunt Device <sup>3</sup> 5. Bus Section	3∅	None
P6 Multiple Contingency (Two overlapping singles)	Loss of one of the followed by system adjustments: 1. Transmission Circuits 2. Transformer <sup>2</sup> 3. Shunt Device <sup>3</sup>	Loss of one of the following: 1. Transmission Circuits 2. Transformer <sup>2</sup> 3. Shunt Device <sup>3</sup>	3∅	None
P7 Multiple Contingency	Normal system	Loss of one of the following: 1. Cascading Generators 2. Transmission Corridor 3. Any two adjacent circuits on common structure	SLG	None



Table F – 4: Steady State & Stability Performance Extreme Events

<p>Steady State &amp; Stability</p> <p>For all extreme events evaluated:</p> <ol style="list-style-type: none"> <li>1. Simulate the removal of all elements that Protection Systems and automatic controls are expected to disconnect for each Contingency.</li> <li>2. Simulate normal clearing unless otherwise specified.</li> </ol>	
<p>Steady State</p> <ol style="list-style-type: none"> <li>1. Loss of a single generator, transmission circuit, shunt device, or transformer force out of service followed by another single generator, transmission circuit, shunt device, or transformer forced out of service prior to system adjustments.</li> <li>2. Local area events affecting the Transmission System such as:                         <ol style="list-style-type: none"> <li>a. Loss of a tower line with three or more circuits<sup>6</sup>.</li> <li>b. Loss of all transmission lines on a common Right-of-Way<sup>6</sup></li> <li>c. Loss of a switching station or substation (loss of one voltage level plus transformers).</li> <li>d. Loss of all generating units at a generating station.</li> <li>e. Loss of a large load or major load center.</li> </ol> </li> <li>3. Wide area events affecting the Transmission System based on system topology such as:                         <ol style="list-style-type: none"> <li>a. Loss of two generating stations resulting from conditions such as:                                 <ol style="list-style-type: none"> <li>i. Loss of a large fuel line into an area.</li> <li>ii. Loss of the use of a large body of water as the cooling source for generation.</li> <li>iii. Wildfires</li> <li>iv. Severe weather, for example, hurricanes</li> <li>v. A successful cyber attack</li> <li>vi. Large earthquake, tsunami or volcanic eruption</li> </ol> </li> <li>b. Other events based upon operating experience that may result in wide area disturbances.</li> </ol> </li> </ol>	<p>Stability</p> <ol style="list-style-type: none"> <li>1. Loss of a single generator, transmission circuit, shunt device, or transformer force out of service apply a 3Ø fault on another single generator, transmission circuit, shunt device, or transformer prior to system adjustments.</li> <li>2. Local area events affecting the Transmission System such as:                         <ol style="list-style-type: none"> <li>a. 3Ø fault on generator with stuck breaker<sup>5</sup> or a relay failure resulting in delayed fault clearing.</li> <li>b. 3Ø fault on transmission circuit with stuck breaker<sup>5</sup> or a relay failure resulting in delayed fault clearing.</li> <li>c. 3Ø fault on transformer with stuck breaker<sup>5</sup> or a relay failure resulting in delayed fault clearing.</li> <li>d. 3Ø fault on bus section with stuck breaker<sup>5</sup> or a relay failure resulting in delayed fault clearing.</li> <li>e. 3Ø internal breaker fault<sup>4</sup>.</li> <li>f. Other events based upon operating experience, such as consideration of initiating events that experience, such as consideration of initiating events that experience suggests may result in wide area disturbances.</li> </ol> </li> </ol>





Table F – 5: Steady State &amp; Stability Performance Footnotes (Planning Events and Extreme Events)

## Planning Events and Extreme Events

1. Unless specified otherwise, simulate Normal Clearing of faults. Single line to ground (SLG) or three-phase (3 $\emptyset$ ) are the fault types that must be evaluated in Stability simulations for the event described. A 3 $\emptyset$  or a double line to ground fault study indicating the criteria are being met is sufficient evidence that a SLG condition would also meet the criteria.
2. For non-generator step up transformer outage events, the reference voltage, applies to the low-side winding (excluding tertiary windings). For generator and Generator Step Up transformer outage events, the reference voltage applies to the BES connected voltage (high-side of the Generator Step Up transformer). Requirements which are applicable to transformers also apply to variable frequency transformers and phase shifting transformers.
3. Requirements which are applicable to shunt devices also apply to FACTS devices that are connected to ground.
4. An internal breaker fault means a breaker failing internally, thus creating a System fault which must be cleared by protection on both sides of the breaker.
5. A stuck breaker means that for a gang-operated breaker, all three phases of the breaker have remained closed. For an independent pole operated (IPO) or an independent pole tripping (IPT) breaker, only one pole is assumed to remain closed. A stuck breaker results in Delayed Fault Clearing.
6. Excludes circuits that share a common structure (Planning event P7, Extreme event steady state 2a) or common Right-of-Way (Extreme event, steady state 2b) for 1 mile or less.

For purposes of this standard, non-redundant components of a Protection System to consider are as follows:

- a. A single protective relay which responds to electrical quantities, without an alternative (which may or may not respond to electrical quantities) that provides comparable Normal Clearing times;
- b. A single communications system associated with protective functions, necessary for correct operation of a communication-aided protection scheme required for Normal Clearing (an exception is a single communications system that is both monitored and reported at a Control Center);
- c. A single station dc supply associated with protective functions required for Normal Clearing (an exception is a single station dc supply that is both monitored and reported at a Control Center for both low voltage and open circuit);
- d. A single control circuitry (including auxiliary relays and lockout relays) associated with protective functions, from the dc supply through and including the trip coil(s) of the circuit breakers or other interrupting devices, required for Normal Clearing (the trip coil may be excluded if it is both monitored and reported at a Control Center).



---

## F.2. HAWAI'I ISLAND TRANSMISSION CRITERIA

### F.2.1. PURPOSE

The purpose of these criteria is to establish guidelines for planning the Hawaiian Electric Hawai'i Island Transmission System to ensure safe and reliable service to its customers to serve current and future system needs. These criteria also apply to facilities that interconnect to the Hawai'i Island Transmission System. The primary objectives of these criteria to maintain reliable Transmission System operation (i.e., continuity of service) include the following:

- Ensure public safety.
- Maintain system stability under a wide range of operating conditions identified in Section F.2.8.
- Maintain equipment operating limits under a wide range of operating conditions identified in Section F.2.8.
- Minimize losses where cost effective.
- Preserve the reliability of the existing transmission infrastructure.
- Maintain an acceptable level of impact to customers for contingencies and events as defined within this planning criteria.
- Prevent cascading outages or system failure following credible contingencies and events.

The criteria outlined below are intended to be used as a general guide in planning the Hawai'i Island Transmission System, for which transmission needs for reinforcement, enhancements, and mitigations will be determined.

### F.2.2. DEFINITIONS

**Acceptable Damping:** A continuous attenuation of oscillations required to achieve equilibrium over a four-cycle period.

**Cascading:** The uncontrolled successive loss of System Elements triggered by an incident at any location. Cascading results in widespread electric service interruption that cannot be restrained from sequentially spreading beyond an area predetermined by studies. (Source: Glossary of Terms Used in NERC Reliability Standards; Effective Date July 1, 2016)

**Consequential Load Loss:** All load that is no longer served by the Transmission System as a result of Transmission System Facilities being removed from service by a Protection System operation designed to isolate a fault. (Source: Glossary of Terms Used in NERC Reliability Standards; Effective Date January 1, 2015)



**Contingency:** The unexpected failure or outage of a system component, such as a generator, transmission line, circuit breaker, switch or other electrical element. (Source: Glossary of Terms Used in NERC Reliability Standards; February 8, 2005)

**Contingency Reserve:** The provision of capacity deployed by the Balancing Authority to meet reliability requirements in Section F.2.8.

**Corrective Action Plan:** A list of actions and an associated timetable for implementation to remedy a specific problem. (Source: Glossary of Terms Used in NERC Reliability Standards; February 7, 2006)

**Distributed Energy Resources or DER:** Resources interconnected to the distribution system that produce electricity.

**Droop Response or Primary Frequency Response:** Open-loop proportional control defined as a percentage of turbine speed or system frequency divided by its rated capacity (i.e., turbine or IBR rating). For a 5% droop response, a unit operating at full speed no load or zero output will instantaneously, without any intentional time delays, issue a control signal to export 100% rated capacity for a 5% decrease in turbine speed or system frequency.

**Element or Elements:** Any electrical device with terminals that may be connected to other electrical devices such as a generator, transformer, circuit breaker, bus section, or transmission line. An Element may be comprised of one or more components. (Source: Glossary of Terms Used in NERC Reliability Standards; Effective Date July 1, 2016)

**Equipment Rating:** The maximum and minimum voltage, current, frequency, real and reactive power flows on individual equipment under steady state, short-circuit and transient conditions, as permitted or assigned by the equipment owner. (Source: Glossary of Terms Used in NERC Reliability Standards; February 8, 2005)

**Extreme Events:** Less frequent but more severe Contingencies that could result in a cascading effect.

**Facility or Facilities:** A set of electrical equipment that operates as a single bulk electric system Element (for example, a line, a generator, a shunt compensator, transformer, etc.). (Source: Glossary of Terms Used in NERC Reliability Standards; February 7, 2006)

**Fast Frequency Response:** Power injected to (or absorbed from) the grid in response to changes in measured or observed frequency during the arresting phase of a frequency excursion event to improve the frequency nadir or initial rate-of-change of frequency. (Source: NERC Fast Frequency Response Concepts and Bulk Power System Reliability Needs – NERC Inverter-Based Resource Performance Task Force; March 2020)

**Inverter-Based Resource:** A resource that is asynchronously connected to the sub-transmission or Transmission System through power electronics.

**Long-Term Transmission Planning Horizon:** Transmission planning period that covers years six through ten or beyond when required to accommodate any known longer lead time projects that



may take longer than ten years to complete. (Source: Glossary of Terms Used in NERC Reliability Standards; Effective Date January 1, 2015)

**Near-Term Transmission Planning Horizon:** The transmission planning period that covers year one through five. (Source: Glossary of Terms Used in NERC Reliability Standards; January 24, 2011)

**Non-Consequential Load Loss:** Load that is disconnected from the system by the utility to stabilize system frequency or voltage. Non-Consequential Load loss does not include: (1) Consequential Load Loss, (2) the response of voltage sensitive load, or (3) load that is disconnected from the system by end-user equipment.

**Planning Assessment:** Documented evaluation of future Transmission System performance and Corrective Action Plans to remedy identified deficiencies. (Source: Glossary of Terms Used in NERC Reliability Standards; Effective Date January 1, 2015)

**Protection System:** Includes, protective relays which respond to electrical quantities; communications systems necessary for correct operation of protective functions; voltage and current sensing devices providing inputs to protective relays; station dc supply associated with protective functions (including station batteries, battery chargers, and non-battery-based dc supply); and control circuitry associated with protective functions through the trip coil(s) of the circuit breakers or other interrupting devices. (Source: Glossary of Terms Used in NERC Reliability Standards; Effective Date April 1, 2013)

**Short Circuit Ratio or SCR<sup>69</sup>:** Short circuit ratio is defined as the ratio between short circuit apparent power (SCMVA) from a 3LG fault at a given location in the power system to the rating of the Inverter-Based Resource connected to that location. Since the numerator of the SCR metric is dependent on the specific measurement location, this location is usually stated along with the SCR number.

$$SCR_{POI} = \frac{SCMVA_{POI}}{MW_{IBR}}$$

Where SCMVA is the short circuit MVA level at the POI without the current contribution of the Inverter-Based Resource, and MW IBR is the nominal power rating of the Inverter-Based Resource being connected at the POI.

**Stability:** The ability of an electric system to maintain a state of equilibrium during normal and abnormal conditions or disturbances. (Source: Glossary of Terms Used in NERC Reliability Standards; February 8, 2005)

**System:** A combination of generation, transmission, and distribution components. (Source: Glossary of Terms Used in NERC Reliability Standards; February 8, 2005)

---

<sup>69</sup> NERC Reliability Guidelines, December 2017 - Integrating Inverter Based Resources into Low Short Circuit Ratio Systems



**Termination:** Point at which an Element or Elements connect to a transmission bus or bay.

**Transmission System:** A network of circuits that operate at a nominal voltage of 69 kV. The Transmission System can also include sections of the 34.5 kV sub-transmission system as defined by these criteria.

**Weak Grid:** A transmission system that has at least one transmission node with a calculated short circuit ratio of less than 3 (i.e., SCR < 3).

### F.2.3. TRANSMISSION SYSTEM DEFINED

For the purpose of these criteria, the Transmission System is defined as all transmission lines, substation equipment, structures, and land utilized for transporting power at 69 kV & 34.5 kV. In addition, the 69-34.5 kV, 69-13.8 kV, and 34.5-13.8 kV tie transformers are part of the Transmission System.

### F.2.4. TRANSMISSION PLANNING CRITERIA – THERMAL LIMITS

At a minimum, the Hawai'i Island system shall meet the performance requirements specified by Planning Events P<sub>0</sub> through P<sub>4</sub> in Section F.2.8. In addition, the Hawai'i Island Transmission System shall meet the following steady-state performance requirements:

- 1) With any generating unit offline for maintenance, all Transmission System Elements will operate within their EMERGENCY ratings while maintaining voltage levels within their upper or lower limits for any of the following outages:
  - Any other generating unit or IBR that is deemed as a single Contingency equivalent
  - Any synchronous condenser or IBR equivalent
  - Any transmission circuit
  - Any transmission transformer
  - Any transmission bus
  - Any wood transmission structure
- 2) Any generating station must be able to export real and reactive power equal to the sum of the individual generating unit's NORMAL capability ratings in MW at 100 percent of rated generator field current/power factor with no Transmission System Element loading exceeding its EMERGENCY ratings while maintaining voltage levels within their upper or lower limits for any of the following outages:
  - Any transmission circuit
  - Any wood transmission structure
  - Any transmission transformer
  - Any transmission bus



Additionally, for any transmission Element outage, the aggregate generating capacity on any remaining radial transmission circuit will not exceed the maximum single-point failure for the system.

- 3) The outage of not more than one generating unit Termination caused by the failure of a transmission circuit breaker to operate during fault conditions.
- 4) With two 69 kV transmission circuits on common steel poles taken out of service at the same time for maintenance, all Transmission System Elements will operate within their EMERGENCY ratings while maintaining voltage levels within their upper or lower limits. This is a maintenance requirement based on present maintenance practices.

Excessive segmentation of a 69 kV or a 34 kV transmission line can result in increasingly complex protection coordination schemes, greater susceptibility to mis-operation of relays, maintenance and operational issues, and excessive curtailment of resources for certain transmission line contingencies. The total generation on any transmission line must be limited to the single-point failure capacity of the system. Generating Facilities should interconnect to an existing substation if practical or interconnect to multiple transmission lines through a new standard configured transmission substation.

## F.2.5. LOADING LIMITS

Conductor loading limits are based on the Overhead Engineering Standards or by ampacity calculations for Underground circuits performed by Engineering. Operational planning mitigations that utilize operator interventions within the duration of allowed Equipment Ratings are not governed by this transmission planning criteria.

### F.2.5.1. Power Transformer Loading Limits

Loading limits of transmission power transformers shall be as follows:

- 1) The normal loading limit of a transmission power transformer shall be its zero percent loss-of-life kVA capability.
- 2) The emergency loading limit of a transmission power transformer shall be its one percent loss-of-life kVA capability.
- 3) The extreme emergency loading limit of a transmission power transformer shall be 200 percent of its maximum nameplate rating.

Loading limits shall be determined in accordance with the latest edition of C-57.92, ANSI Guide for Loading Mineral - Oil - Immersed Power Transformers Up to and Including 100 MVA with 55°C or 65°C Winding Rise.



## F.2.5.2. Current Carrying Capacity

### Overhead

Conductors for overhead transmission lines shall be considered to have current carrying capacity in accordance with Engineering Standard 1-2038, "Current Carrying Capacity Outdoor Bare Conductor" or other applicable standard. A conductor bundle with identical conductors shall have the rating of a single conductor multiplied by the number of conductors per phase in the bundle.

### Underground

Cable for underground transmission circuits shall be based on ampacity calculations performed by Engineering.

### Open Bus

Open buses shall be considered to have current carrying capacity in accordance with Engineering Standard, 1-2039, "Current Carrying Capacity- Outdoor Open Bus" or other applicable standard.

### Power Transformer Equipment

Transmission power transformer connections, switches, protective relays, and current transformers shall be designed to allow the power transformer to carry 200 percent of maximum nameplate rating under extreme emergency conditions in accordance with the latest edition of C-57.92, ANSI Guide for Loading Mineral - Oil - Immersed Power Transformers Up to and Including 100 MVA with 55°C or 65°C Winding Rise. (The relay settings associated with this type of transformer shall allow the transformer to carry 200 percent of maximum nameplate rating.)

### Substation Equipment

Switches, disconnects, circuit breakers, and associated equipment shall be considered to have a current carrying capacity equivalent to their respective nameplate current rating.



### F.2.5.3. Generator MVAR Loading Limits

For planning purposes, the reactive capability of a given machine will be determined using the manufacturer's machine capability curve and normal MW at rated power factor for generating units. At no time will the system be planned with any generator or IBR exceeding its rating as determined by its capability curve corresponding to the appropriate ambient temperature suitable for the Hawai'i Island system.

### F.2.6. VOLTAGE LEVELS

Transmission voltage levels shall be kept within the prescribed limits for any condition for which the Transmission System is planned. These limits apply after automatic corrective action has been taken by LTC and/or switched capacitors.

The maximum voltage limits are based on *Utility Service in the State of Hawaii* (General Order No.7).

- 1) 69 kV System. For any system operating condition, the voltage at any 69 kV bus shall not exceed 72.5 kV.
- 2) 34.5 kV System. For any system operating condition, the voltage on the 34.5 kV system shall not exceed 36.2 kV.

The minimum voltage limits are based upon maintaining customer voltages in accordance with *Standards for Electric Utility Service in the State of Hawaii* (General Order No.7). To accomplish this, bus voltages at the transmission and sub-transmission substations must be maintained within the limits that are used to plan the distribution system.

- 1) 69 kV System. The minimum allowable voltage on any 69 kV bus is 62.1 kV for any emergency condition for which the transmission system is planned.
- 2) 34.5 kV System. The minimum allowable voltage on any 34.5 kV bus is 31.05 kV for any emergency condition for which the system is planned.

The system's short-circuit current requirements and resources should be considered when evaluating near-term voltage and MVAR mitigation alternatives.

### F.2.7. SYSTEM STABILITY

Displacement of synchronous generation has a direct impact on dynamic and transient stability. In addition to traditional analyses, new planning metrics and analysis are required to maintain Stability under plausible operating conditions. If the conditions for Weak Grid are met, further analysis may be required in appropriate software modeling platform to fully investigate any Stability concerns.





### F.2.7.1. Steady State Voltage

The power-voltage (PV) and reactive power-voltage (QV) analysis shall be performed to determine the steady-state voltage stability of critical load buses.

Figure F- 2: Typical PV Curve

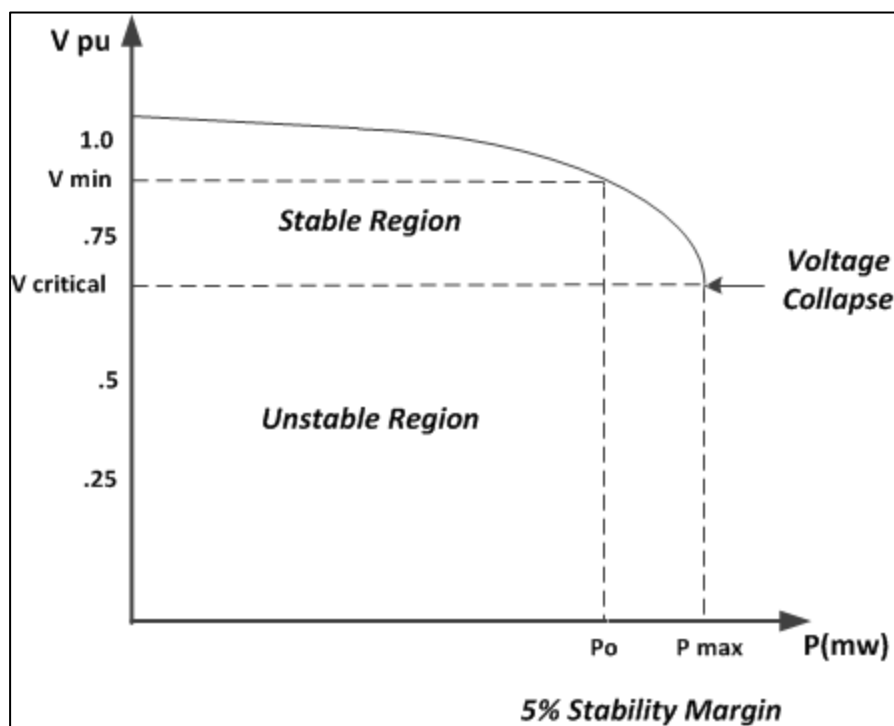


Figure F- 2 shows a typical PV curve that depicts the thermal limit of the transmission system. To ensure voltage stability, a 5% margin from  $P_0$  to  $P_{max}$ , identified as  $P_0$ , shall be maintained under planning events described in Section F.2.8. In addition, the intersection of the QV curve with the x-axis shall occur above the minimum allowable voltage level, and the reactive power margin, represented by the value at the minimum point of the QV curve, shall be greater than the size of a nearby capacitor bank or reactive power device.

### F.2.7.2. Weak Grid Assessment

Weak power systems are more susceptible to voltage transients and can be exacerbated by control instabilities. Short circuit ratio (SCR) is the most basic metric to assess the relative strength of an electrical system for a specific area when evaluating performance of a specific IBR<sup>70</sup>. For system

<sup>70</sup> NERC Reliability Guideline – Integrating Variable Energy Resources into Weak Power Systems



planning purposes, a more appropriate quantity is the weighted short circuit ratio (WSCR)<sup>71</sup>, defined by:

$$WSCR = \frac{\sum_i^N SCMVA_i * P_{RMW_i}}{(\sum_i^N P_{RMW_i})^2}$$

Where  $SCMVA_i$  is the short circuit capacity at bus  $i$  and  $P_{RMW_i}$  is the MW rating of the IBR;  $N$  is the number of total IBR fully interacting with each other and  $i$  is the IBR index. The WSCR takes into account the aggregate IBR of the system to ensure the system has sufficient short circuit current for transient voltage stability. There is currently no industry standard for WSCR of a transmission system.

## Control Stability

Control stability refers to the behavior of grid-connected IBR like wind and solar PV plants to operate in a stable manner for both small disturbances and large disturbances on the grid over a wide range of operating conditions and disturbances. Unstable behavior can result in oscillatory behavior, extreme overshoots in voltage or current, and/or a failure to ride-through a disturbance. The stability of equipment controls is impacted by many factors, including equipment tuning, operating conditions, grid strength, disturbance types, and the electrical proximity to other IBR or synchronous machines on the grid, among others.

As more IBR with complex control system connect to the system, it is important to assess the control stability of these resources to assess the robustness of controls to the range of expected operating conditions over the planning horizon. This will be done through a combination of screening, scenario modeling, and testing/demonstration of performance. As such, supplying accurate and sufficiently detailed models of equipment and functional descriptions of equipment control and protection schemes is necessary well in advance of interconnection. Equipment performance will be evaluated for combinations of:

- Full and partial power operating conditions, high and low voltages (within continuous limits)
- Symmetric and asymmetric fault disturbances (with reclosing), line switching disturbances, loss of generation and load disturbances
- Low grid strength conditions

The system shall maintain operating equilibrium with acceptable damping ratio of 3% for all reasonable combinations of planned outages and system contingencies defined in Section 8.4. Power oscillations exhibit an acceptable damping ratio of 3% when the oscillation magnitude decreases by 17% over the first period of oscillation, or by 53% over four periods of oscillations.

<sup>71</sup> Electranix, System Strength Assessment of the Panhandle System, Electric Reliability Council of Texas, 2016



### F.2.7.3. Rotor Angle Stability Criteria

Rotor angle stability simulations involve the evaluation of critical clearing times ("CCT") for close-in faults to generating stations, generating units, and transmission lines. Generator rotor angle deviation with respect to a "distant" generator shall be less than 180 degrees to prevent generator pole-slipping and in addition to avoiding loss of synchronism. Dynamic performance shall exhibit acceptable damping to ensure rotor angle stability. Pole-slipping could impose mechanical stresses on the generator shaft and could result in catastrophic failure of the unit.

#### Critical Clearing Times

The Transmission Planning Department performs Stability simulations using the standard fault clearing times for breakers provided by the System Protection Department. If a fault event results in a planning criteria violation, the Transmission Planning Department shall determine the CCT for that event and will provide it to the System Protection Department for its review and feedback. If the CCT cannot be achieved by the existing protective devices, Transmission Planning Department will work with System Protection Department to develop appropriate mitigation measures. Such mitigation measures may include but not limited to the system protection upgrade, generator size or power export reduction, application of synchronous condenser or adjustments to resource commitment as applicable.

### F.2.7.4. Frequency Stability

Frequency stability is determined by 1) the amount of inertia on the system; 2) the amount and response characteristics of fast-frequency and primary frequency response reserves on the system; and 3) the magnitude of the generation Contingency. The system shall carry sufficient, fast and timely delivered frequency response (including some combination of rotating machine inertia, frequency response reserves, and inverter-based frequency response capabilities) to mitigate credible contingencies, including expected aggregate loss of distributed energy resources in response to the Contingency events, with appropriate Non-Consequential Load Loss criteria defined in Section F.2.8. In order to meet these criteria, mitigation measures may require establishing minimum inertia requirement for a generation loss event.

#### Planning Criteria for Stability

Stability of an electric power system is the attribute of the system to regain a state of operating equilibrium after being subjected to disrupting forces (Contingency events), such that the majority of the system remains intact. Generating units and transmission Elements must remain online and in synchronism with the system to prevent an island-wide blackout. Therefore, the Transmission



System shall be tested by simulating frequent Contingency events and reasonable cascading contingency events that may occur on the system to ensure operating equilibrium is restored.

- 1) For the more frequent types of contingencies listed below, not more than one generating unit can disconnect from the system, all remaining generating units must remain connected and synchronized to the system, all remaining generating units must participate towards beneficial system response, no circuits should trip on stability swings, transient voltage stability must be maintained, and Non-Consequential Load Loss defined in Section F.2.2.
  - Normally cleared, three-phase faults on transmission lines with automatic reclosing as applicable to the circuit being analyzed.
  - Delayed clearing of three-phase faults due to failure of the pilot relay on circuits that have one pilot scheme, and one step-distance scheme for backup to the pilot scheme. Dual-pilot relay schemes require independent communication technologies (e.g., both microwave and fiber-optic cable) to mitigate failure of single-pilot relay schemes. Analysis shall be performed for the simulation of the longest delayed clearing time scenario.
  - Delayed clearing of single line-to-ground faults due to failure of a circuit breaker to open.

Exceptions include small units (e.g., internal combustion engines) that share a common generator step-up transformer and combined-cycle units. Other exceptions will be considered on a case-by-case basis.

- 2) For the less frequent contingencies listed below, Non-Consequential Load Loss or generator tripping may be required to prevent equipment damage and maintain Stability.
  - Sudden loss of all transmission lines emanating from a power plant switching station.
  - Sudden loss of all transmission lines in a common right-of-way.
  - Sudden loss of any combined cycle units or any two synchronous generating units (synchronous, asynchronous, or both), including any aggregate loss of DER.
  - Sudden loss of any combination of two transmission Elements.
  - Cascading loss of generation
- 3) Extreme Events – For Extreme Events system preservation shall be tested. An objective of the planning process should be to minimize the likelihood and magnitude of Non-Consequential Load Loss following Contingency events. If any Extreme Events result in an island-wide blackout, mitigation measures shall be formulated and analyzed to see if a reasonable solution can be implemented. Examples of Extreme Events include but not limited to:
  - A three-phase fault on generator, transmission circuit, transformer or bus section with stuck breaker resulting in delayed fault clearing
  - A three-phase fault on generator, transmission circuit, transformer or bus section with failure of a non-redundant component of a Protection System resulting in delayed fault clearing
  - Three phase internal breaker fault
  - Other events based upon operating experience, such as consideration of initiating events that experience suggests may result in wide area disturbances



## F.2.8. TRANSMISSION PLANNING ASSESSMENT

A Planning Assessment of the Transmission System must be performed on an annual basis to ensure compliance with these criteria for the Near-Term Planning Horizon and Long-Term Planning Horizons. This Planning Assessment must use current models to analyze steady-state, dynamic, and transient system stability to ensure compliance with these criteria. Updated assumptions, forecasts, and study results shall be summarized and documented in a report.

### F.2.8.1. Near-Term Transmission Planning Horizon

The Near-Term Transmission Planning Horizon should assess a five year period and evaluate year one, year five, and any other year in between that has a significant system change, e.g., the planned addition or deactivation of a generating unit, the addition of a transmission line, etc. As a minimum, the study shall assess system performance for the following operating periods and conditions:

- Day minimum load (high DER, low gross load)
- Day peak load (low DER, high gross load)
- Evening peak load
- Night minimum load

Base cases may include consideration of each major unit outage period. Sensitivity cases may include consideration of system conditions and operating periods beyond the conditions listed above.

For each of these periods, only the applicable Stability analysis and system events shall be performed. Additional sensitivity cases and/or analyses should be performed on an as-needed basis to ensure system performance meets the stability criteria specified in Section F.2.7, and may be informed by identified operational constraints.

The Planning Assessment should periodically analyze cascading Contingency events to ensure preservation of the system for plausible planning events. As a minimum, the system shall meet performance requirements of Planning Events P5 through P7 from Table F - 7.

### F.2.8.2. Long-Term Transmission Planning Horizon

The Long-Term Transmission Planning Horizon should be performed in conjunction with the Integrated Grid Planning process. Evaluation years will be dictated by the proposed resource plans. As a minimum, the study shall assess system performance for the following operating periods and conditions:

- Day minimum load (high DER, low gross load)
- Day peak load (low DER, high gross load)
- Evening peak load



- Night minimum load

For each of these periods, only the applicable Stability analysis and system events shall be performed. Models of future generating units will not be readily available; therefore, discretion should be used in: 1) developing the scope of work and sensitivity cases for this Planning Assessment and 2) interpreting results of these analyses.

### F.2.8.3. Past Studies

Past studies may be used to support the Planning Assessment if they meet the following requirements:

- For steady state, short circuit, or Stability analysis:
  - The study must contain a technical rationale that can be provided to demonstrate that the results of an older study are still valid, or
  - No material changes have occurred to the system represented in the study. Documentation to support the technical rationale for determining material changes must be included.

### F.2.8.4. Planning Events

As a minimum, the Stability criteria in Section F.2.7 ensures that the transmission system meets or exceeds the performance requirements of Planning Events P<sub>1</sub> through P<sub>4</sub> in Table F - 7. A periodic assessment of the under-frequency load shed scheme should be performed to ensure that the system meets the minimum requirements of Planning Events P<sub>5</sub> through P<sub>7</sub> in Table F - 7.

Table F – 6: Steady State and Stability Performance Planning Events

<p>Steady State &amp; Stability:</p> <ol style="list-style-type: none"> <li>1. The system must remain stable. Cascading and uncontrolled islanding shall not occur.</li> <li>2. Consequential Load Loss as well as generation loss is acceptable as a consequence of any event excluding P<sub>0</sub>.</li> <li>3. Simulate the removal of all elements that Protection Systems and other controls are expected to automatically disconnect for each event.</li> <li>4. Simulate normal clearing unless otherwise specified.</li> <li>5. Planned system adjustments such as transmission configuration changes and re-dispatch of generation are allowed if such adjustments are executable within the time duration applicable to the Equipment Rating.</li> <li>6. Phase angle separation for line Contingency shall not preclude automatic reclosing unless system adjustments can be performed within fifteen minutes.</li> </ol> <p>Steady State Only:</p>
--



- 7. Applicable Equipment Rating must not be exceeded.
- 8. System steady state voltages and post-Contingency voltage deviations must be within acceptable limits as established by this Planning Criteria.
- 9. Planning event P0 is applicable to steady state only.

Table F – 7: Categories of Contingency Events

Category	Initial Condition	Event	Fault(s) Type <sup>1</sup>	Non-Consequential Load Loss Allowed
P0 No Contingency	Normal system	None	N/A	None
P1 Single Contingency	Normal system	Loss of one of the following: 1. Generator 2. Transmission Circuits 3. Transformer <sup>2</sup> 4. Shunt Device-Ancillary Service Device <sup>3</sup>	3Ø	Up to 15% for Generator Trip Only
		5. Generator – no fault	N/A	
P2 Single Contingency	Normal system	1. Bus Section fault 2. Internal Breaker Fault <sup>4</sup> (Transmission line breaker)	3Ø	Up to 15%
P3 Single Contingency	Loss of generator unit followed by system adjustments (e.g., corrective action and re-dispatch)	Loss of one of the following: 1. Generator 2. Transmission Circuits 3. Transformer 4. Shunt Device/ Ancillary Service Device	3Ø	Up to 20%
P4 Multiple Contingency (Fault plus stuck breaker <sup>5</sup> )	Normal system	Loss of multiple elements caused by a stuck breaker (non-Bus-tie Breaker) attempting to clear a fault on one of the following: 1. Generator 2. Transmission Circuits 3. Transformer <sup>2</sup> 4. Shunt Device <sup>3</sup> 5. Bus Section	SLG	Up to 40%
		6. Loss of multiple elements caused by a stuck breaker (Bus-tie Breaker) attempting to clear a fault on the associated bus	SLG	Up to 40%
P5 Multiple Contingency (Fault plus non-redundant component of a Protection System failure to operate)	Normal system	Delayed fault clearing due to the failure of a non-redundant component of a Protection System protecting the faulted element to operate as designed, for one of the following: 1. Generator 2. Transmission Circuits 3. Transformer <sup>2</sup> 4. Shunt Device <sup>3</sup> 5. Bus Section	3Ø	Up to 15%



Category	Initial Condition	Event	Fault(s) Type <sup>1</sup>	Non-Consequential Load Loss Allowed
P6 Multiple Contingency (Two overlapping singles)	Loss of one of the followed by system adjustments: 1. Transmission Circuits 2. Transformer <sup>2</sup> 3. Shunt Device <sup>3</sup>	Loss of one of the following: 1. Transmission Circuits 2. Transformer <sup>2</sup> 3. Shunt Device <sup>3</sup>	3Ø	Up to 65%
P7 Multiple Contingency	Normal system	Loss of one of the following: 1. Cascading Generators 2. Transmission Corridor 3. Any two adjacent circuits on common structure	SLG	Up to 65%

Table F – 8: Steady State & Stability Performance Extreme Events

<p><b>Steady State &amp; Stability</b></p> <p>For all extreme events evaluated:</p> <ol style="list-style-type: none"> <li>1. Simulate the removal of all elements that Protection Systems and automatic controls are expected to disconnect for each Contingency.</li> <li>2. Simulate normal clearing unless otherwise specified.</li> </ol>	
<p><b>Steady State</b></p> <ol style="list-style-type: none"> <li>1. Loss of a single generator, transmission circuit, shunt device, or transformer force out of service followed by another single generator, transmission circuit, shunt device, or transformer forced out of service prior to system adjustments.</li> <li>2. Local area events affecting the Transmission System such as:                     <ol style="list-style-type: none"> <li>a. Loss of a tower line with three or more circuits<sup>6</sup>.</li> <li>b. Loss of all transmission lines on a common Right-of-Way<sup>6</sup></li> <li>c. Loss of a switching station or substation (loss of one voltage level plus transformers).</li> <li>d. Loss of all generating units at a generating station.</li> <li>e. Loss of a large load or major load center.</li> </ol> </li> <li>3. Wide area events affecting the Transmission System based on system topology such as:</li> </ol>	<p><b>Stability</b></p> <ol style="list-style-type: none"> <li>1. Loss of a single generator, transmission circuit, shunt device, or transformer force out of service apply a 3Ø fault on another single generator, transmission circuit, shunt device, or transformer prior to system adjustments.</li> <li>2. Local area events affecting the Transmission System such as:                     <ol style="list-style-type: none"> <li>a. 3Ø fault on generator with stuck breaker<sup>5</sup> or a relay failure resulting in delayed fault clearing.</li> <li>b. 3Ø fault on transmission circuit with stuck breaker<sup>5</sup> or a relay failure resulting in delayed fault clearing.</li> <li>c. 3Ø fault on transformer with stuck breaker<sup>5</sup> or a relay failure resulting in delayed fault clearing.</li> <li>d. 3Ø fault on bus section with stuck breaker<sup>5</sup> or a relay failure resulting in delayed fault clearing.</li> <li>e. 3Ø internal breaker fault<sup>4</sup>.</li> <li>f. Other events based upon operating experience, such as consideration of</li> </ol> </li> </ol>





<ul style="list-style-type: none"> <li>a. Loss of two generating stations resulting from conditions such as:             <ul style="list-style-type: none"> <li>i. Loss of a large fuel line into an area.</li> <li>ii. Loss of the use of a large body of water as the cooling source for generation.</li> <li>iii. Wildfires</li> <li>iv. Severe weather, for example, hurricanes</li> <li>v. A successful cyber attack</li> <li>vi. Large earthquake, tsunami or volcanic eruption</li> </ul> </li> <li>b. Other events based upon operating experience that may result in wide area disturbances.</li> </ul>	<p>initiating events that experience, such as consideration of initiating events that experience suggests may result in wide area disturbances.</p>
--	---

Table F – 9: Steady State & Stability Performance Footnotes (Planning Events and Extreme Events)

<p>Planning Events and Extreme Events</p> <ol style="list-style-type: none"> <li>1. Unless specified otherwise, simulate Normal Clearing of faults. Single line to ground (SLG) or three-phase (3Ø) are the fault types that must be evaluated in Stability simulations for the event described. A 3Ø or a double line to ground fault study indicating the criteria are being met is sufficient evidence that a SLG condition would also meet the criteria</li> <li>2. For non-generator step up transformer outage events, the reference voltage, applies to the low-side winding (excluding tertiary windings). For generator and Generator Step Up transformer outage events, the reference voltage applies to the BES connected voltage (high-side of the Generator Step Up transformer). Requirements which are applicable to transformers also apply to variable frequency transformers and phase shifting transformers.</li> <li>3. Requirements which are applicable to shunt devices also apply to FACTS devices that are connected to ground.</li> <li>4. An internal breaker fault means a breaker failing internally, thus creating a System fault which must be cleared by protection on both sides of the breaker.</li> <li>5. A stuck breaker means that for a gang-operated breaker, all three phases of the breaker have remained closed. For an independent pole operated (IPO) or an independent pole tripping (IPT) breaker, only one pole is assumed to remain closed. A stuck breaker results in Delayed Fault Clearing.</li> <li>6. Excludes circuits that share a common structure (Planning event P7, Extreme event steady state 2a) or common Right-of-Way (Extreme event, steady state 2b) for 1 mile or less.</li> </ol> <p>For purposes of this standard, non-redundant components of a Protection System to consider are as follows:</p>
---



- a. A single protective relay which responds to electrical quantities, without an alternative (which may or may not respond to electrical quantities) that provides comparable Normal Clearing times;
- b. A single communications system associated with protective functions, necessary for correct operation of a communication-aided protection scheme required for Normal Clearing (an exception is a single communications system that is both monitored and reported at a Control Center);
- c. A single station dc supply associated with protective functions required for Normal Clearing (an exception is a single station dc supply that is both monitored and reported at a Control Center for both low voltage and open circuit);
- d. A single control circuitry (including auxiliary relays and lockout relays) associated with protective functions, from the dc supply through and including the trip coil(s) of the circuit breakers or other interrupting devices, required for Normal Clearing (the trip coil may be excluded if it is both monitored and reported at a Control Center).

---

## F.3. MAUI TRANSMISSION CRITERIA

### F.3.1. PURPOSE

The purpose of these criteria is to establish guidelines for planning the Hawaiian Electric Maui Island Transmission System to ensure safe and reliable service to its customers to serve current and future system needs. These criteria also apply to facilities that interconnect to the Maui Island Transmission System. The primary objectives of these criteria to maintain reliable Transmission System operation (i.e., continuity of service) include the following:

- Ensure public safety.
- Maintain system stability under a wide range of operating conditions identified in Section F.3.8.
- Maintain equipment operating limits under a wide range of operating conditions identified in Section F.3.8.
- Minimize losses where cost effective.
- Preserve the reliability of the existing transmission infrastructure.
- Maintain an acceptable level of impact to customers for contingencies and events as defined within this planning criteria.
- Prevent cascading outages or system failure following credible contingencies and events.

The criteria outlined below are intended to be used as a general guide in planning the Maui Island Transmission System, for which transmission needs for reinforcement, enhancements, and mitigations will be determined.



### F.3.2. DEFINITIONS

**Acceptable Damping:** A continuous attenuation of oscillations required to achieve equilibrium over a four-cycle period.

**Cascading:** The uncontrolled successive loss of System Elements triggered by an incident at any location. Cascading results in widespread electric service interruption that cannot be restrained from sequentially spreading beyond an area predetermined by studies. (Source: Glossary of Terms Used in NERC Reliability Standards; Effective Date July 1, 2016)

**Consequential Load Loss:** All load that is no longer served by the Transmission System as a result of Transmission System Facilities being removed from service by a Protection System operation designed to isolate a fault. (Source: Glossary of Terms Used in NERC Reliability Standards; Effective Date January 1, 2015)

**Contingency:** The unexpected failure or outage of a system component, such as a generator, transmission line, circuit breaker, switch or other electrical element. (Source: Glossary of Terms Used in NERC Reliability Standards; February 8, 2005)

**Contingency Reserve:** The provision of capacity deployed by the Balancing Authority to meet reliability requirements in Section F.3.8.

**Corrective Action Plan:** A list of actions and an associated timetable for implementation to remedy a specific problem. (Source: Glossary of Terms Used in NERC Reliability Standards; February 7, 2006)

**Distributed Energy Resources or DER:** Resources interconnected to the distribution system that produce electricity.

**Droop Response or Primary Frequency Response:** Open-loop proportional control defined as a percentage of turbine speed or system frequency divided by its rated capacity (i.e., turbine or IBR rating). For a 5% droop response, a unit operating at full speed no load or zero output will instantaneously, without any intentional time delays, issue a control signal to export 100% rated capacity for a 5% decrease in turbine speed or system frequency.

**Element or Elements:** Any electrical device with terminals that may be connected to other electrical devices such as a generator, transformer, circuit breaker, bus section, or transmission line. An Element may be comprised of one or more components. (Source: Glossary of Terms Used in NERC Reliability Standards; Effective Date July 1, 2016)

**Equipment Rating:** The maximum and minimum voltage, current, frequency, real and reactive power flows on individual equipment under steady state, short-circuit and transient conditions, as permitted or assigned by the equipment owner. (Source: Glossary of Terms Used in NERC Reliability Standards; February 8, 2005)

**Extreme Events:** Less frequent but more severe Contingencies that could result in a cascading effect.



**Facility or Facilities:** A set of electrical equipment that operates as a single bulk electric system Element (for example, a line, a generator, a shunt compensator, transformer, etc.). (Source: Glossary of Terms Used in NERC Reliability Standards; February 7, 2006)

**Fast Frequency Response:** Power injected to (or absorbed from) the grid in response to changes in measured or observed frequency during the arresting phase of a frequency excursion event to improve the frequency nadir or initial rate-of-change of frequency. (Source: NERC Fast Frequency Response Concepts and Bulk Power System Reliability Needs – NERC Inverter-Based Resource Performance Task Force; March 2020)

**Inverter-Based Resource:** A resource that is asynchronously connected to the sub-transmission or Transmission System through power electronics.

**Long-Term Transmission Planning Horizon:** Transmission planning period that covers years six through ten or beyond when required to accommodate any known longer lead time projects that may take longer than ten years to complete. (Source: Glossary of Terms Used in NERC Reliability Standards; Effective Date January 1, 2015)

**Near-Term Transmission Planning Horizon:** The transmission planning period that covers year one through five. (Source: Glossary of Terms Used in NERC Reliability Standards; January 24, 2011)

**Non-Consequential Load Loss:** Load that is disconnected from the system by the utility to stabilize system frequency or voltage. Non-Consequential Load loss does not include: (1) Consequential Load Loss, (2) the response of voltage sensitive load, or (3) load that is disconnected from the system by end-user equipment.

**Planning Assessment:** Documented evaluation of future Transmission System performance and Corrective Action Plans to remedy identified deficiencies. (Source: Glossary of Terms Used in NERC Reliability Standards; Effective Date January 1, 2015)

**Protection System:** Includes, protective relays which respond to electrical quantities; communications systems necessary for correct operation of protective functions; voltage and current sensing devices providing inputs to protective relays; station dc supply associated with protective functions (including station batteries, battery chargers, and non-battery-based dc supply); and control circuitry associated with protective functions through the trip coil(s) of the circuit breakers or other interrupting devices. (Source: Glossary of Terms Used in NERC Reliability Standards; Effective Date April 1, 2013)

**Short Circuit Ratio or SCR<sup>72</sup>:** Short circuit ratio is defined as the ratio between short circuit apparent power (SCMVA) from a 3LG fault at a given location in the power system to the rating of the Inverter-Based Resource connected to that location. Since the numerator of the SCR metric is dependent on the specific measurement location, this location is usually stated along with the SCR number.

---

<sup>72</sup> NERC Reliability Guidelines, December 2017 - Integrating Inverter Based Resources into Low Short Circuit Ratio Systems



$$SCR_{POI} = \frac{SCMVA_{POI}}{MW_{IBR}}$$

Where SCMVA is the short circuit MVA level at the POI without the current contribution of the Inverter-Based Resource, and MW IBR is the nominal power rating of the Inverter-Based Resource being connected at the POI.

**Stability:** The ability of an electric system to maintain a state of equilibrium during normal and abnormal conditions or disturbances. (Source: Glossary of Terms Used in NERC Reliability Standards; February 8, 2005)

**System:** A combination of generation, transmission, and distribution components. (Source: Glossary of Terms Used in NERC Reliability Standards; February 8, 2005)

**Termination:** Point at which an Element or Elements connect to a transmission bus or bay.

**Transmission System:** A network of circuits that operate at a nominal voltage of 69 kV and 23 kV.

**Weak Grid:** A transmission system that has at least one transmission node with a calculated short circuit ratio of less than 3 (i.e.,  $SCR < 3$ ).

### F.3.3. TRANSMISSION SYSTEM DEFINED

For the purpose of these criteria, the Transmission System is defined as all transmission lines, substation equipment, structures, and land utilized for transporting power at 69 kV and 23 kV. In addition, the 69-23 kV tie transformers are part of the Transmission System.

### F.3.4. TRANSMISSION PLANNING CRITERIA – THERMAL LIMITS

At a minimum, the Maui Island system shall meet the performance requirements specified by Planning Events Po through P4 in Section F.3.8. In addition, the Maui Island Transmission System shall meet the following steady-state performance requirements:

- 1) With any generating unit offline for maintenance, all Transmission System Elements will operate within their EMERGENCY ratings while maintaining voltage levels within their upper or lower limits for any of the following outages:
  - Any other generating unit or IBR that is deemed as a single Contingency equivalent
  - Any synchronous condenser or IBR equivalent
  - Any transmission circuit
  - Any transmission transformer
  - Any transmission bus
  - Any wood transmission structure



- 2) Any generating station must be able to export real and reactive power equal to the sum of the individual generating unit's NORMAL capability ratings in MW at 100 percent of rated generator field current/power factor with no Transmission System Element loading exceeding its EMERGENCY ratings while maintaining voltage levels within their upper or lower limits for any of the following outages:
  - Any transmission circuit
  - Any wood transmission structure
  - Any transmission transformer
  - Any transmission bus

Additionally, for any transmission Element outage, the aggregate generating capacity on any remaining radial transmission circuit will not exceed the maximum single-point failure for the system.

- 3) The outage of not more than one generating unit Termination caused by the failure of a transmission circuit breaker to operate during fault conditions.
- 4) With two 69 kV transmission circuits on common steel poles taken out of service at the same time for maintenance, all Transmission System Elements will operate within their EMERGENCY ratings while maintaining voltage levels within their upper or lower limits. This is a maintenance requirement based on present maintenance practices.

Excessive segmentation of a 69 kV or 23 kV transmission line can result in increasingly complex protection coordination schemes, greater susceptibility to mis-operation of relays, maintenance and operational issues, and excessive curtailment of resources for certain transmission line contingencies. The total generation on any transmission line must be limited to the single-point failure capacity of the system. Generating Facilities should interconnect to an existing substation if practical or interconnect to multiple transmission lines through a new standard configured transmission substation.

### F.3.5. LOADING LIMITS

Conductor loading limits are based on the Overhead Engineering Standards or by ampacity calculations for Underground circuits performed by Engineering. Operational planning mitigations that utilize operator interventions within the duration of allowed Equipment Ratings are not governed by this transmission planning criteria.

#### F.3.5.1. Power Transformer Loading Limits

Loading limits of transmission power transformers shall be as follows:

- 1) The normal loading limit of a transmission power transformer shall be its zero percent loss-of-life kVA capability.



- 2) The emergency loading limit of a transmission power transformer shall be its one percent loss-of-life kVA capability.
- 3) The extreme emergency loading limit of a transmission power transformer shall be 200 percent of its maximum nameplate rating.

Loading limits shall be determined in accordance with the latest edition of C-57.92, ANSI Guide for Loading Mineral - Oil - Immersed Power Transformers Up to and Including 100 MVA with 55°C or 65°C Winding Rise.

### F.3.5.2. Current Carrying Capacity

#### Overhead

Conductors for overhead transmission lines shall be considered to have current carrying capacity in accordance with Engineering Standard 1-2038, "Current Carrying Capacity Outdoor Bare Conductor" or other applicable standard. A conductor bundle with identical conductors shall have the rating of a single conductor multiplied by the number of conductors per phase in the bundle.

#### Underground

Cable for underground transmission circuits shall be based on ampacity calculations performed by Engineering.

#### Open Bus

Open buses shall be considered to have current carrying capacity in accordance with Engineering Standard, 1-2039, "Current Carrying Capacity- Outdoor Open Bus."

#### Power Transformer Equipment

Transmission power transformer connections, switches, protective relays, and current transformers shall be designed to allow the power transformer to carry 200 percent of maximum nameplate rating under extreme emergency conditions in accordance with the latest edition of C-57.92, ANSI Guide for Loading Mineral - Oil - Immersed Power Transformers Up to and Including 100 MVA with 55°C or 65°C Winding Rise. (The relay settings associated with this type of transformer shall allow the transformer to carry 200 percent of maximum nameplate rating.)



## Substation Equipment

Switches, disconnects, circuit breakers, and associated equipment shall be considered to have a current carrying capacity equivalent to their respective nameplate current rating.

### F.3.5.3. Generator MVAR Loading Limits

For planning purposes, the reactive capability of a given machine will be determined using the manufacturer's machine capability curve and normal MW at rated power factor for generating units. At no time will the system be planned with any generator or IBR exceeding its rating as determined by its capability curve corresponding to the appropriate ambient temperature suitable for the Maui Island system.

### F.3.6. VOLTAGE LEVELS

Transmission voltage levels shall be kept within the prescribed limits for any condition for which the Transmission System is planned. These limits apply after automatic corrective action has been taken by LTC and/or switched capacitors.

The maximum voltage limits are based on *Utility Service in the State of Hawaii* (General Order No.7).

- 1) 69 kV System. For any system operating condition, the voltage at any 69 kV bus shall not exceed 72.5 kV.
- 2) 23 kV System. For any system operating condition, the voltage on the 23 kV system shall not exceed 24.15 kV.

The minimum voltage limits are based upon maintaining customer voltages in accordance with *Standards for Electric Utility Service in the State of Hawaii* (General Order No.7). To accomplish this, bus voltages at the transmission substations must be maintained within the limits that are used to plan the distribution system.

- 1) 69 kV System. The minimum allowable voltage on any 69 kV bus is 62.1 kV for any emergency condition for which the transmission system is planned.
- 2) 23 kV System. The minimum allowable voltage on any 23 kV bus is 20.7 kV for any emergency condition for which the system is planned.

The system's short-circuit current requirements and resources should be considered when evaluating near-term voltage and MVAR mitigation alternatives.





### F.3.7. SYSTEM STABILITY

Displacement of synchronous generation has a direct impact on dynamic and transient stability. In addition to traditional analyses, new planning metrics and analysis are required to maintain Stability under plausible operating conditions. If the conditions for Weak Grid are met, further analysis may be required in appropriate software modeling platform to fully investigate any Stability concerns.

#### F.3.7.1. Steady State Voltage

The power-voltage (PV) and reactive power-voltage (QV) analysis shall be performed to determine the steady-state voltage stability of critical load buses.

Figure F- 3: Typical PV Curve

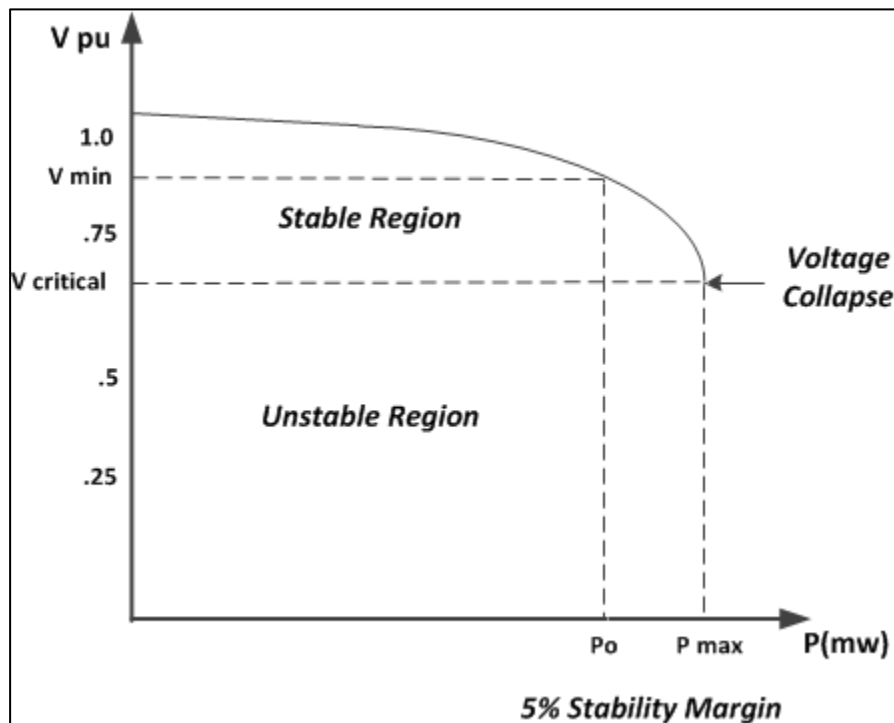


Figure F- 3 shows a typical PV curve that depicts the thermal limit of the transmission system. To ensure voltage stability, a 5% margin from  $P_0$  to  $P_{max}$ , identified as  $P_0$ , shall be maintained under planning events described in Section F.3.8. In addition, the intersection of the QV curve with the x-axis shall occur above the minimum allowable voltage level, and the reactive power margin, represented by the value at the minimum point of the QV curve, shall be greater than the size of a nearby capacitor bank or reactive power device.

### F.3.7.2. Weak Grid Assessment

Weak power systems are more susceptible to voltage transients and can be exacerbated by control instabilities. Short circuit ratio (SCR) is the most basic metric to assess the relative strength of an electrical system for a specific area when evaluating performance of a specific IBR<sup>73</sup>. For system planning purposes, a more appropriate quantity is the weighted short circuit ratio (WSCR)<sup>74</sup>, defined by:

$$WSCR = \frac{\sum_i^N SCMVA_i * P_{RMW_i}}{(\sum_i^N P_{RMW_i})^2}$$

Where **SCMVA<sub>i</sub>** is the short circuit capacity at bus **i** and **P<sub>RMW<sub>i</sub></sub>** is the MW rating of the IBR; **N** is the number of total IBR fully interacting with each other and **i** is the IBR index. The WSCR takes into account the aggregate IBR of the system to ensure the system has sufficient short circuit current for transient voltage stability. There is currently no industry standard for WSCR of a transmission system.

### Control Stability

Control stability refers to the behavior of grid-connected IBR like wind and solar PV plants to operate in a stable manner for both small disturbances and large disturbances on the grid over a wide range of operating conditions and disturbances. Unstable behavior can result in oscillatory behavior, extreme overshoots in voltage or current, and/or a failure to ride-through a disturbance. The stability of equipment controls is impacted by many factors, including equipment tuning, operating conditions, grid strength, disturbance types, and the electrical proximity to other IBR or synchronous machines on the grid, among others.

As more IBR with complex control system connect to the system, it is important to assess the control stability of these resources to assess the robustness of controls to the range of expected operating conditions over the planning horizon. This will be done through a combination of screening, scenario modeling, and testing/demonstration of performance. As such, supplying accurate and sufficiently detailed models of equipment and functional descriptions of equipment control and protection schemes is necessary well in advance of interconnection. Equipment performance will be evaluated for combinations of:

- Full and partial power operating conditions, high and low voltages (within continuous limits)
- Symmetric and asymmetric fault disturbances (with reclosing), line switching disturbances, loss of generation and load disturbances
- Low grid strength conditions

<sup>73</sup> NERC Reliability Guideline – Integrating Variable Energy Resources into Weak Power Systems

<sup>74</sup> Electranix, System Strength Assessment of the Panhandle System, Electric Reliability Council of Texas, 2016



The system shall maintain operating equilibrium with acceptable damping ratio of 3% for all reasonable combinations of planned outages and system contingencies defined in Section 8.4. Power oscillations exhibit an acceptable damping ratio of 3% when the oscillation magnitude decreases by 17% over the first period of oscillation, or by 53% over four periods of oscillations.

### F.3.7.3. Rotor Angle Stability Criteria

Rotor angle stability simulations involve the evaluation of critical clearing times ("CCT") for close-in faults to generating stations, generating units, and transmission lines. Generator rotor angle deviation with respect to a "distant" generator shall be less than 180 degrees to prevent generator pole-slipping and in addition to avoiding loss of synchronism. Dynamic performance shall exhibit acceptable damping to ensure rotor angle stability. Pole-slipping could impose mechanical stresses on the generator shaft and could result in catastrophic failure of the unit.

### Critical Clearing Times

The Transmission Planning Department performs Stability simulations using the standard fault clearing times for breakers provided by the System Protection Department. If a fault event results in a planning criteria violation, the Transmission Planning Department shall determine the CCT for that event and will provide it to the System Protection Department for its review and feedback. If the CCT cannot be achieved by the existing protective devices, Transmission Planning Department will work with System Protection Department to develop appropriate mitigation measures. Such mitigation measures may include but not limited to the system protection upgrade, generator size or power export reduction, application of synchronous condenser or adjustments to resource commitment as applicable.

### F.3.7.4. Frequency Stability

Frequency stability is determined by 1) the amount of inertia on the system; 2) the amount and response characteristics of fast-frequency and primary frequency response reserves on the system; and 3) the magnitude of the generation Contingency. The system shall carry sufficient, fast and timely delivered frequency response (including some combination of rotating machine inertia, frequency response reserves, and inverter-based frequency response capabilities) to mitigate credible contingencies, including expected aggregate loss of distributed energy resources in response to the Contingency events, with appropriate Non-Consequential Load Loss criteria defined in Section F.3.8. In order to meet these criteria, mitigation measures may require establishing minimum inertia requirement for a generation loss event.



## Planning Criteria for Stability

Stability of an electric power system is the attribute of the system to regain a state of operating equilibrium after being subjected to disrupting forces (Contingency events), such that the majority of the system remains intact. Generating units and transmission Elements must remain online and in synchronism with the system to prevent an island-wide blackout. Therefore, the Transmission System shall be tested by simulating frequent Contingency events and reasonable cascading contingency events that may occur on the system to ensure operating equilibrium is restored.

- 1) For the more frequent types of contingencies listed below, not more than one generating unit can disconnect from the system, all remaining generating units must remain connected and synchronized to the system, all generating units must participate towards beneficial system response, no circuits should trip on stability swings, transient voltage stability must be maintained, and Non-Consequential Load Loss defined in Section F.3.8 is allowable.
  - Normally cleared, three-phase faults on transmission lines with automatic reclosing as applicable to the circuit being analyzed.
  - Delayed clearing of three-phase faults due to failure of the pilot relay on circuits that have one pilot scheme, and one step-distance scheme for backup to the pilot scheme. Dual-pilot relay schemes require independent communication technologies (e.g., both microwave and fiber-optic cable) to mitigate failure of single-pilot relay schemes. Analysis shall be performed for the simulation of the longest delayed clearing time scenario.
  - Delayed clearing of single line-to-ground faults due to failure of a circuit breaker to open. Exceptions include small units (e.g., internal combustion engines) that share a common generator step-up transformer and combined-cycle units. Other exceptions will be considered on a case-by-case basis.
- 2) For the less frequent contingencies listed below, increased amounts of Non-Consequential Load Loss or generator tripping may be required to prevent equipment damage and maintain Stability.
  - Sudden loss of all transmission lines emanating from a power plant switching station.
  - Sudden loss of all transmission lines in a common right-of-way.
  - Sudden loss of any combined cycle units or any two synchronous generating units (synchronous, asynchronous, or both), including any aggregate loss of DER.
  - Sudden loss of any combination of two transmission Elements.
  - Cascading loss of generation
- 3) Extreme Events – For Extreme Events system preservation shall be tested. An objective of the planning process should be to minimize the likelihood and magnitude of Non-Consequential Load Loss following Contingency events. If any Extreme Events result in an island-wide blackout, mitigation measures shall be formulated and analyzed to see if a reasonable solution can be implemented. Examples of Extreme Events include but not limited to:
  - A three-phase fault on generator, transmission circuit, transformer or bus section with stuck breaker resulting in delayed fault clearing
  - A three-phase fault on generator, transmission circuit, transformer or bus section with failure of a non-redundant component of a Protection System resulting in delayed fault clearing



- Three phase internal breaker fault
- Other events based upon operating experience, such as consideration of initiating events that experience suggests may result in wide area disturbances

### F.3.8. TRANSMISSION PLANNING ASSESSMENT

A Planning Assessment of the Transmission System must be performed on an annual basis to ensure compliance with these criteria for the Near-Term Planning Horizon and Long-Term Planning Horizons. This Planning Assessment must use current models to analyze steady-state, dynamic, and transient system stability to ensure compliance with these criteria. Updated assumptions, forecasts, and study results shall be summarized and documented in a report.

#### F.3.8.1. Near-Term Transmission Planning Horizon

The Near-Term Transmission Planning Horizon should assess a five-year period and evaluate year one, year five, and any other year in between that has a significant system change, e.g., the planned addition or deactivation of a generating unit, the addition of a transmission line, etc. As a minimum, the study shall assess system performance for the following operating periods and conditions:

- Day minimum load (high DER, low gross load)
- Day peak load (low DER, high gross load)
- Evening peak load
- Night minimum load

Base cases may include consideration of each major unit outage period. Sensitivity cases may include consideration of system conditions and operating periods beyond the conditions listed above.

For each of these periods, only the applicable Stability analysis and system events shall be performed. Additional sensitivity cases and/or analyses should be performed on an as-needed basis to ensure system performance meets the stability criteria specified in Section F.3.7, and may be informed by identified operational constraints.

The Planning Assessment should periodically analyze cascading Contingency events to ensure preservation of the system for plausible planning events. As a minimum, the system shall meet performance requirements of Planning Events P5 through P7 from Table F - 11.

#### F.3.8.2. Long-Term Transmission Planning Horizon

The Long-Term Transmission Planning Horizon should be performed in conjunction with the Integrated Grid Planning process. Evaluation years will be dictated by the proposed resource plans.



As a minimum, the study shall assess system performance for the following operating periods and conditions:

- Day minimum load (high DER, low gross load)
- Day peak load (low DER, high gross load)
- Evening peak load
- Night minimum load

For each of these periods, only the applicable Stability analysis and system events shall be performed. Models of future generating units will not be readily available; therefore, discretion should be used in: 1) developing the scope of work and sensitivity cases for this Planning Assessment and 2) interpreting results of these analyses.

### F.3.8.3. Past Studies

Past studies may be used to support the Planning Assessment if they meet the following requirements:

- For steady state, short circuit, or Stability analysis:
  - The study must contain a technical rationale that can be provided to demonstrate that the results of an older study are still valid, or
  - No material changes have occurred to the system represented in the study. Documentation to support the technical rationale for determining material changes must be included.

### F.3.8.4. Planning Events

As a minimum, the Stability criteria in F.3.7 ensures that the transmission system meets or exceeds the performance requirements of Planning Events P<sub>1</sub> through P<sub>4</sub> in Table F - 11. A periodic assessment of the under-frequency load shed scheme should be performed to ensure that the system meets the minimum requirements of Planning Events P<sub>5</sub> through P<sub>7</sub> in Table F - 11.



Table F – 10: Steady State and Stability Performance Planning Events

<p>Steady State &amp; Stability:</p> <ol style="list-style-type: none"> <li>1. The system must remain stable. Cascading and uncontrolled islanding shall not occur.</li> <li>2. Consequential Load Loss as well as generation loss is acceptable as a consequence of any event excluding P0.</li> <li>3. Simulate the removal of all elements that Protection Systems and other controls are expected to automatically disconnect for each event.</li> <li>4. Simulate normal clearing unless otherwise specified.</li> <li>5. Planned system adjustments such as transmission configuration changes and re-dispatch of generation are allowed if such adjustments are executable within the time duration applicable to the Equipment Rating.</li> <li>6. Phase angle separation for line Contingency shall not preclude automatic reclosing unless system adjustments can be performed within fifteen minutes.</li> </ol> <p>Steady State Only:</p> <ol style="list-style-type: none"> <li>7. Applicable Equipment Rating must not be exceeded.</li> <li>8. System steady state voltages and post-Contingency voltage deviations must be within acceptable limits as established by this Planning Criteria.</li> <li>9. Planning event P0 is applicable to steady state only.</li> </ol>
--

Table F – 11: Categories of Contingency Events

Category	Initial Condition	Event	Fault(s) Type <sup>1</sup>	Non-Consequential Load Loss Allowed
P0 No Contingency	Normal system	None	N/A	None
P1 Single Contingency	Normal system	Loss of one of the following: <ol style="list-style-type: none"> <li>1. Generator</li> <li>2. Transmission Circuits</li> <li>3. Transformer<sup>2</sup></li> <li>4. Shunt Device-Ancillary Service Device<sup>3</sup></li> </ol>	3Ø	Up to 15% for Generator Trip Only
		5. Generator - no fault	N/A	
P2 Single Contingency	Normal system	<ol style="list-style-type: none"> <li>1. Bus Section fault</li> <li>2. Internal Breaker Fault<sup>4</sup> (Transmission line breaker)</li> </ol>	3Ø	Up to 15%

P3 Single Contingency	Loss of generator unit followed by system adjustments (e.g., corrective action and re-dispatch)	Loss of one of the following: 1. Generator 2. Transmission Circuits 3. Transformer 4. Shunt Device/ Ancillary Service Device	3Ø	Up to 20%
P4 Multiple Contingency (Fault plus stuck breaker <sup>5</sup> )	Normal system	Loss of multiple elements caused by a stuck breaker <sup>5</sup> (non-Bus-tie Breaker) attempting to clear a fault on one of the following: 1. Generator 2. Transmission Circuits 3. Transformer <sup>2</sup> 4. Shunt Device <sup>3</sup> 5. Bus Section	SLG	Up to 40%
		6. Loss of multiple elements caused by a stuck breaker <sup>5</sup> (Bus-tie Breaker) attempting to clear a fault on the associated bus	SLG	Up to 40%
P5 Multiple Contingency (Fault plus non-redundant component of a Protection System failure to operate)	Normal system	Delayed fault clearing due to the failure of a non-redundant component of a Protection System protecting the faulted element to operate as designed, for one of the following: 1. Generator 2. Transmission Circuits 3. Transformer <sup>2</sup> 4. Shunt Device <sup>3</sup> 5. Bus Section	3Ø	Up to 15%
P6 Multiple Contingency (Two overlapping singles)	Loss of one of the followed by system adjustments: 1. Transmission Circuits 2. Transformer <sup>2</sup> 3. Shunt Device <sup>3</sup>	Loss of one of the following: 1. Transmission Circuits 2. Transformer <sup>2</sup> 3. Shunt Device <sup>3</sup>	3Ø	Up to 65%
P7 Multiple Contingency	Normal system	Loss of one of the following: 1. Cascading Generators 2. Transmission Corridor 3. Any two adjacent circuits on common structure	SLG	Up to 65%

Table F – 12: Steady State & Stability Performance Extreme Events

Steady State & Stability  
For all extreme events evaluated:



<ol style="list-style-type: none"> <li>1. Simulate the removal of all elements that Protection Systems and automatic controls are expected to disconnect for each Contingency.</li> <li>2. Simulate normal clearing unless otherwise specified.</li> </ol>	
<p>Steady State</p> <ol style="list-style-type: none"> <li>1. Loss of a single generator, transmission circuit, shunt device, or transformer force out of service followed by another single generator, transmission circuit, shunt device, or transformer forced out of service prior to system adjustments.</li> <li>2. Local area events affecting the Transmission System such as:                         <ol style="list-style-type: none"> <li>a. Loss of a tower line with three or more circuits<sup>6</sup>.</li> <li>b. Loss of all transmission lines on a common Right-of-Way<sup>6</sup></li> <li>c. Loss of a switching station or substation (loss of one voltage level plus transformers).</li> <li>d. Loss of all generating units at a generating station.</li> <li>e. Loss of a large load or major load center.</li> </ol> </li> <li>3. Wide area events affecting the Transmission System based on system topology such as:                         <ol style="list-style-type: none"> <li>a. Loss of two generating stations resulting from conditions such as:                                 <ol style="list-style-type: none"> <li>i. Loss of a large fuel line into an area.</li> <li>ii. Loss of the use of a large body of water as the cooling source for generation.</li> <li>iii. Wildfires</li> <li>iv. Severe weather, for example, hurricanes</li> <li>v. A successful cyber attack</li> <li>vi. Large earthquake, tsunami or volcanic eruption</li> </ol> </li> </ol> </li> </ol>	<p>Stability</p> <ol style="list-style-type: none"> <li>1. Loss of a single generator, transmission circuit, shunt device, or transformer force out of service apply a 3Ø fault on another single generator, transmission circuit, shunt device, or transformer prior to system adjustments.</li> <li>2. Local area events affecting the Transmission System such as:                         <ol style="list-style-type: none"> <li>a. 3Ø fault on generator with stuck breaker<sup>5</sup> or a relay failure resulting in delayed fault clearing.</li> <li>b. 3Ø fault on transmission circuit with stuck breaker<sup>5</sup> or a relay failure resulting in delayed fault clearing.</li> <li>c. 3Ø fault on transformer with stuck breaker<sup>5</sup> or a relay failure resulting in delayed fault clearing.</li> <li>d. 3Ø fault on bus section with stuck breaker<sup>5</sup> or a relay failure resulting in delayed fault clearing.</li> <li>e. 3Ø internal breaker fault<sup>4</sup>.</li> <li>f. Other events based upon operating experience, such as consideration of initiating events that experience, such as consideration of initiating events that experience suggests may result in wide area disturbances.</li> </ol> </li> </ol>

<p>b. Other events based upon operating experience that may result in wide area disturbances.</p>	
---	--

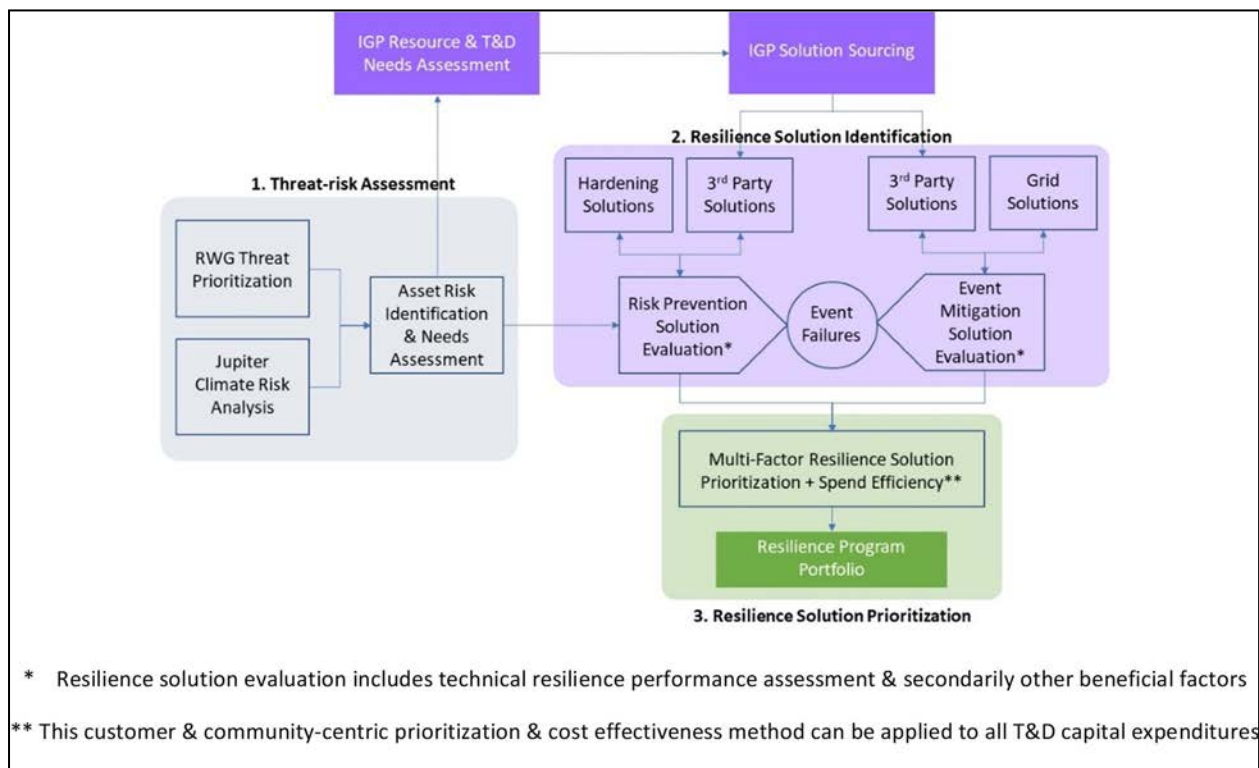
Table F – 13: Steady State & Stability Performance Footnotes

<p>Planning Events and Extreme Events</p> <ol style="list-style-type: none"> <li>1. Unless specified otherwise, simulate Normal Clearing of faults. Single line to ground (SLG) or three-phase (3Ø) are the fault types that must be evaluated in Stability simulations for the event described. A 3Ø or a double line to ground fault study indicating the criteria are being met is sufficient evidence that a SLG condition would also meet the criteria</li> <li>2. For non-generator step up transformer outage events, the reference voltage, applies to the low-side winding (excluding tertiary windings). For generator and Generator Step Up transformer outage events, the reference voltage applies to the BES connected voltage (high-side of the Generator Step Up transformer). Requirements which are applicable to transformers also apply to variable frequency transformers and phase shifting transformers.</li> <li>3. Requirements which are applicable to shunt devices also apply to FACTS devices that are connected to ground.</li> <li>4. An internal breaker fault means a breaker failing internally, thus creating a System fault which must be cleared by protection on both sides of the breaker.</li> <li>5. A stuck breaker means that for a gang-operated breaker, all three phases of the breaker have remained closed. For an independent pole operated (IPO) or an independent pole tripping (IPT) breaker, only one pole is assumed to remain closed. A stuck breaker results in Delayed Fault Clearing.</li> <li>6. Excludes circuits that share a common structure (Planning event P7, Extreme event steady state 2a) or common Right-of-Way (Extreme event, steady state 2b) for 1 mile or less.</li> </ol> <p>For purposes of this standard, non-redundant components of a Protection System to consider are as follows:</p> <ol style="list-style-type: none"> <li>a. A single protective relay which responds to electrical quantities, without an alternative (which may or may not respond to electrical quantities) that provides comparable Normal Clearing times;</li> <li>b. A single communications system associated with protective functions, necessary for correct operation of a communication-aided protection scheme required for Normal Clearing (an exception is a single communications system that is both monitored and reported at a Control Center);</li> <li>c. A single station dc supply associated with protective functions required for Normal Clearing (an exception is a single station dc supply that is both monitored and reported at a Control Center for both low voltage and open circuit);</li> <li>d. A single control circuitry (including auxiliary relays and lockout relays) associated with protective functions, from the dc supply through and including the trip coil(s) of the circuit breakers or other interrupting devices, required for Normal Clearing (the trip coil may be excluded if it is both monitored and reported at a Control Center).</li> </ol>
---

# Appendix G. Resilience Planning Framework

The Companies have been focused on power system resilience in response to the increasing threats from climate change. Resilience planning is about mitigating risks, including outages and public safety. A specific resilience planning process, based on industry best practices, is under development to integrate with IGP. This process has three distinct steps, 1) threat-risk assessment, 2) resilience solution identification, and 3) resilience solution prioritization. This resilience planning approach and linkage with IGP is illustrated Figure G- 1 below.

Figure G- 1: Resilience Planning Approach



The Resilience Working Group (“RWG”) reached a general agreement that all relevant costs need to be captured, which includes the costs that utilities might incur to mitigate severe outages, as well as the cost of the outage to customers and stakeholders.<sup>75</sup> This process attempts to address this objective in the context of a multi-factor evaluation that leads to a risk-spend efficiency prioritization adapting leading resilience planning practices in the industry.

<sup>75</sup> See RWG Report at 57. [https://www.hawaiianelectric.com/documents/clean\\_energy\\_hawaii/integrated\\_grid\\_planning/stakeholder\\_engagement/working\\_groups/resilience/20200429\\_rwg\\_report.pdf](https://www.hawaiianelectric.com/documents/clean_energy_hawaii/integrated_grid_planning/stakeholder_engagement/working_groups/resilience/20200429_rwg_report.pdf)

---

## G.1. THREAT-RISK ASSESSMENT

The Companies' prior efforts with the Department of Defense and critical facilities in our communities has expanded through the work with the RWG. The stakeholder driven threat identification and prioritization combined with customer segmentation and prioritization provide a key input into the resilience planning process. The RWG final report is publicly available.<sup>76</sup>

Jupiter Intelligence's high-resolution climate analytics provide asset-level resolution for short and long-term flooding and wind risk to assess physical risks over a 30-year time horizon to help the Companies address the resiliency of its generation, transmission, and distribution infrastructure. In its first phase, the Jupiter climate risk data will help the Companies prioritize geographic locations and assets that are most at risk. Subsequently, it will provide detailed area analyses of all assets.<sup>77</sup>

The Jupiter locational analysis combined with the RWG prioritization provides the basis for a detailed customer and community-based threat-risk assessment of the Companies' assets. This informs the need, location, and timing of investment to cost effectively provide the level of electric system resilience our customers expect. The result is a set of resilience needs in the form of specific performance requirements to prevent and mitigate event-based risks.

---

## G.2. RESILIENCE SOLUTION IDENTIFICATION

The Companies are applying the "bowtie method" (Figure G- 2) as increasingly used in the industry to leverage risk-threat assessments as described above into a structured solution identification process involving two aspects, event risk prevention and event consequence mitigation. This method, employed in California's wildfire mitigation planning, translates the threat-risk assessment and asset vulnerabilities in Step 1 into specific event risk prevention and mitigation analysis and solution identification. A bow-tie approach helps identify where and how solutions would have the greatest impact for customers and communities.

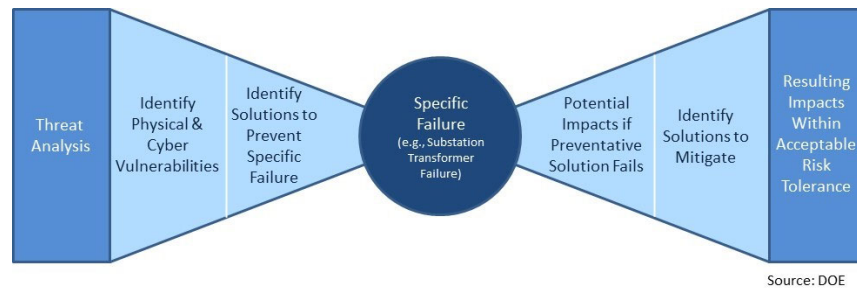
---

<sup>76</sup> Resilience Working Group Report (PDF):

[https://www.hawaiianelectric.com/documents/clean\\_energy\\_hawaii/integrated\\_grid\\_planning/stakeholder\\_engagement/working\\_groups/resilience/20200429\\_rwg\\_report.pdf](https://www.hawaiianelectric.com/documents/clean_energy_hawaii/integrated_grid_planning/stakeholder_engagement/working_groups/resilience/20200429_rwg_report.pdf)

<sup>77</sup> See <https://view.hawaiianelectric.com/jupiter-intelligence-special-report/page/1>

Figure G- 2: “Bowtie Method” Risk-Threat Assessment



This is done by implementing solutions to prevent certain events from causing system failures. Preventive solutions are shown on the left side of the bowtie. Mitigation solutions can either reduce the impact of a failure event or facilitate recovery of the failure to reduce the consequences of an event. Mitigation solutions are shown on the right side of the bowtie. Challenges involve identifying the additional risk exposure from a range of threats and the system impacts given the increasing complexity of a more distributed power system along with the potential overlapping set of grid needs identified in the IGP analyses. The Companies recognize the need to start more simply and evolve sophistication over time as with climate analysis.

The specific prevention and mitigation solutions will be identified through both utility asset options and potential third-party and customer solutions. The utility asset options involve vegetation management, hardening, undergrounding, and increasing switching flexibility, for example. Third-party solutions may involve microgrids, local energy producing resources, and load management. Customer options include back-up generation, storage, and microgrids. The third-party solution opportunities will be incorporated into the IGP sourcing process to streamline and hopefully identify solutions that achieve multiple objectives. The result is a portfolio of solutions to address the various and unique resilience needs of the power system, communities, and individual critical facilities and customers as illustrated in Figure G- 3 below.

Figure G- 3: Resilience Solution Portfolio



Source: De Martini for PNNL

This portfolio is developed by assessing the utility, third-party, and customer solutions against the respective prevention and mitigation performance requirements identified in Step 1. The resulting solution set will then be prioritized in Step 3.

### G.3. RESILIENCE SOLUTION PRIORITIZATION

Resilience solution prioritization involves assessing the comparative customer and community risk reduction value of the solutions related to associated generation, transmission, substation, and distribution infrastructure. The Companies intend to use a risk-spend efficiency (RSE) metric to ascertain the benefit to cost ratio of resilience risk reduction solutions. The benefit is expressed in terms of the magnitude of risk reduction while the costs include solution expenditure. This process begins with assessing solution value in terms of community and customer resilience risk reduction in terms of estimated customer minutes of interruption (CMI) avoided over the planning horizon.

#### G.3.1. LOCATIONAL PROPENSITY FACTOR

The Locational Propensity Factor estimates the potential event risk reduction and the propensity of the event to occur during the planning horizon. Each island and area on each island have different relative levels of exposure to major climate event risk. The Companies' assets have been assessed for the propensity to experience major climate events based on the Jupiter analysis performed in Step 1. While not a predictor of future events, it is nonetheless a

useful factor for prioritizing where to focus on certain efforts. The number of events is multiplied by the estimated outage risk reduction per event provided by a solution. The aggregate avoided CMI value is then considered in relation to community impact.

### G.3.2. COMMUNITY & CUSTOMER IMPACT FACTOR

Resilience events involve long outage durations which can have much larger impacts on Hawaii's national security facilities and communities than short duration outages. As such, assessing the impact on communities involves consideration of national security and community impacts to defense facilities, critical facilities, vulnerable population, and other priorities identified by the RWG stakeholders in Step 1. The RWG identified these priorities in their report and can be applied to assess aggregate community impacts. For example, identifying the defense facilities, critical facilities and number of vulnerable people and assigning weights to reflect the priority of providing electricity to these people and facilities. This would more fully assess the national security, community impacts, and individual population risk reduction from major events.

The resulting weighted community impact number is multiplied by the aggregate CMI value to create a resilience value denoted in avoided CMI.

### G.3.3. OTHER RESILIENCE VALUES

As in California, the monetary impact of avoided safety-related incidents (e.g., wildfire risk mitigation, wires/poles down) can be incorporated. Likewise, damage reduction solutions can also be incorporated (e.g., targeted hardening of poles/structures that would be expensive/difficult to replace after an event due to their location, equipment on pole/structure, etc.)

### G.3.4. NON-RESILIENCE VALUES

Additionally, other desirable values provided by a solution will be considered. For example, if a resilience solution also improved the normal, blue-sky capability to integrate DER or enable electrification these values could be assessed within the IGP framework. The California Public Utility Commission provided direction to identify these types of associated benefits when evaluating resilience solutions. This may involve incorporating a second weighting based on the aggregate value from other factors to apply to the resilience value (CMI). This type of multi-factor weighted value analysis is used in several states, including Michigan. The weighted solution values identified are averaged and used to multiply the CMI value to yield a composite value number.

---

#### G.4. RISK-SPEND EFFICIENCY (RSE) PRIORITIZATION

The last step is to divide the risk reduction value by the cost of the solution (utility or third-party) to determine the risk-spend efficiency of the solution. This approach is an adaptation of the RSE used more narrowly in California for wildfire mitigation planning. This approach aligns with the RWG's recognition that all relevant impacts need to be captured, which includes the impact of a long duration outage to customers and communities as well as the cost that utilities might incur to mitigate severe outages.

The resulting RSE score is used to rank the solutions with the highest ranked solutions prioritized within budget and other financial considerations. This overall framework prioritizes/ranks solutions in respect to specific needs and within an overall portfolio that also accounts for customer-based solutions. As such, this enables the Companies to determine how many solutions of various types are needed in order achieve resilience goals or objectives as a matter of policy (e.g., total length of outage by critical facility/customer tiers).<sup>78</sup>

---

<sup>78</sup> See RWG Report at 59-60.



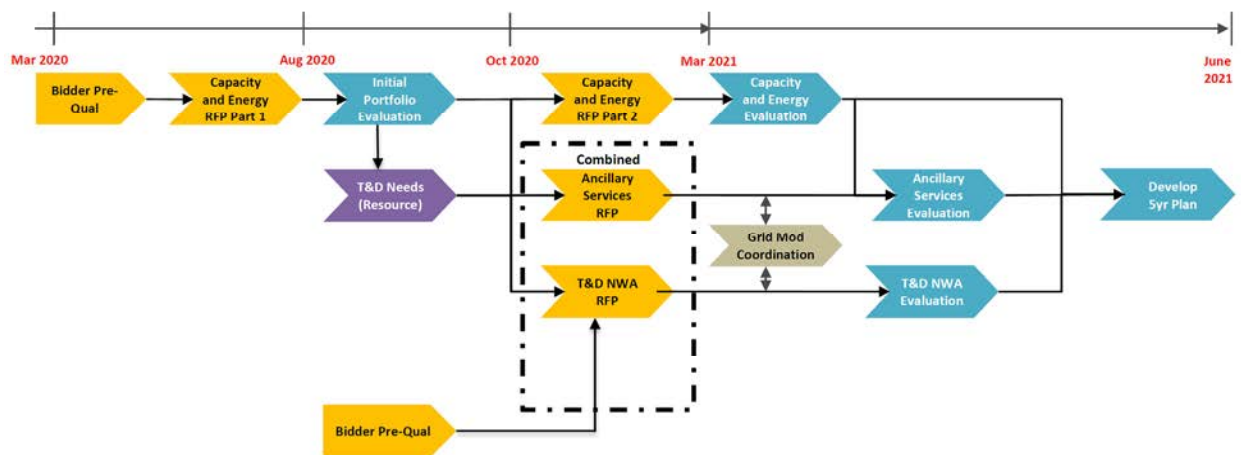
# Appendix H. Solution Sourcing Diagram Evolution

## H.1. IGP PROCESS FOR IDENTIFYING AND SOURCING SOLUTIONS TO MEET GRID NEEDS

The Company’s proposed process for solution sourcing has evolved over the course of several stakeholder meetings in response to developments in the working groups and stakeholder discussion.

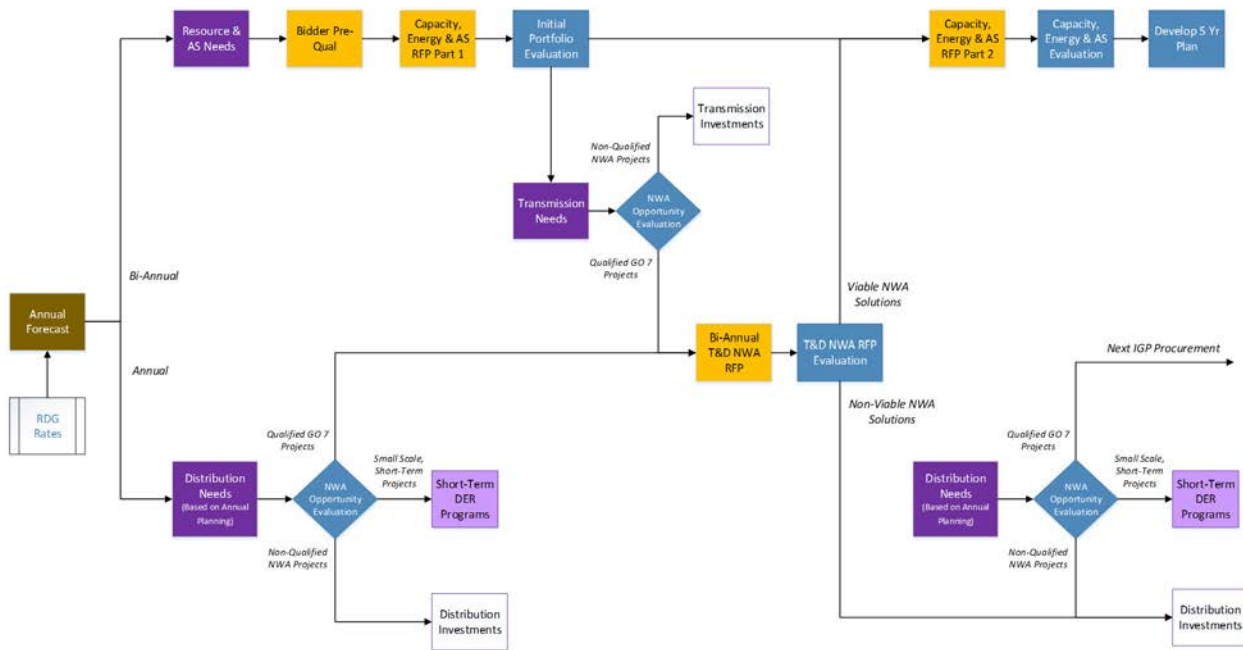
In the first meeting of the Solution Evaluation & Optimization Working Group, a proposed process was introduced to procure capacity, energy, ancillary services, and non-wires alternatives through separate RFPs.

Figure H- 1: Initial Solution Sourcing Proposal Introduced on May 9, 2019



The sourcing diagram was significantly expanded on August 1, 2019 to show the three separate needs assessments conducted for resource and ancillary services, transmission, and distribution. The NWA opportunity evaluation proposed in the Distribution Planning Working Group was incorporated into the process, leading to a T&D NWA RFP for qualified projects<sup>79</sup>.

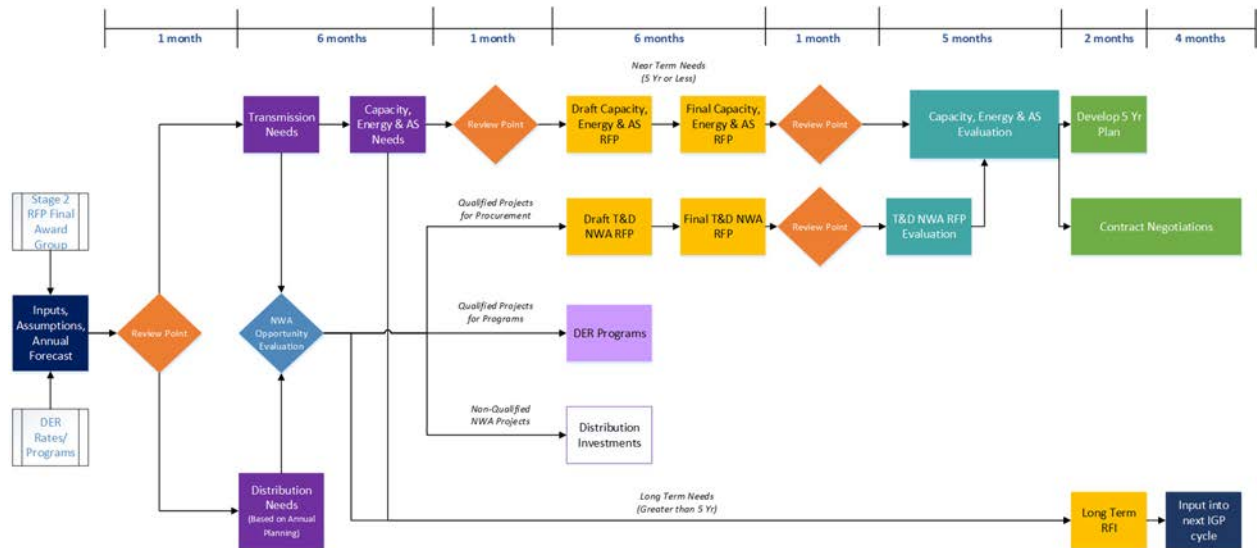
Figure H- 2: Expanded Sourcing Diagram Introduced on August 1, 2019



<sup>79</sup> See Appendix J.

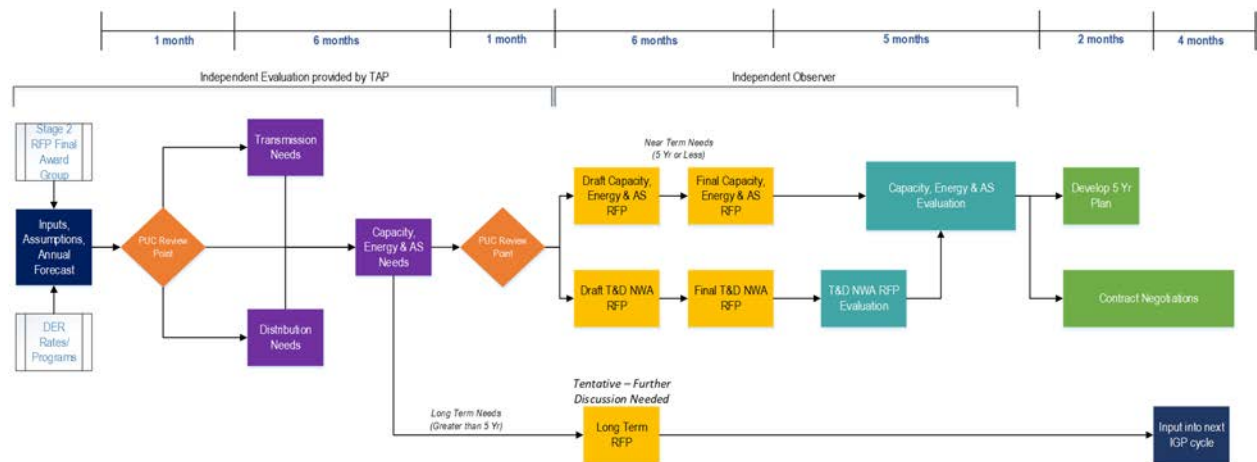
On November 13, 2019, the review points were added to the sourcing diagram. The capacity, energy & ancillary services needs, transmission needs, and distribution needs process steps were reorganized to better show their interdependency and a long term RFI step was introduced based on stakeholder feedback. For all process steps shown, estimated durations were provided in the monthly timeline.

Figure H- 3: Sourcing Diagram Presented on November 13, 2019



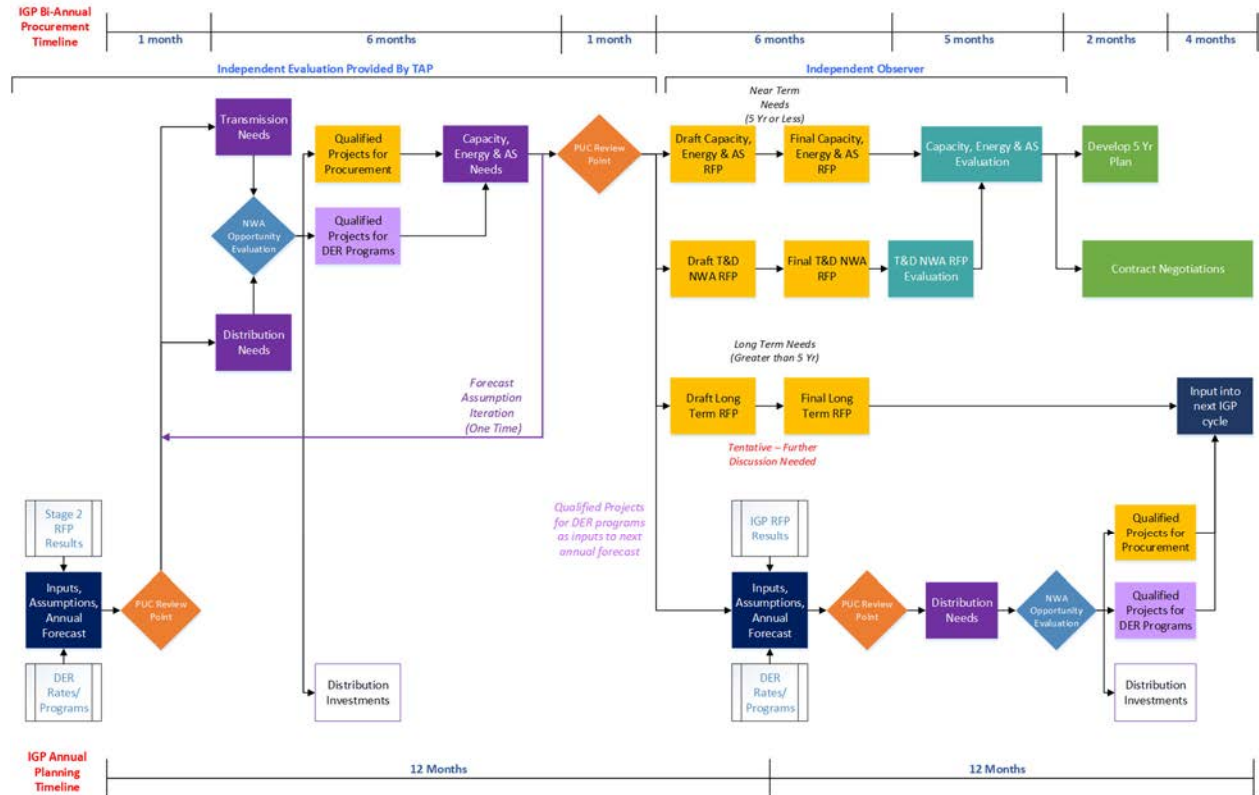
On December 9, 2019, the sourcing diagram was clarified to show both the transmission needs and distribution needs were inputs into the capacity, energy & ancillary services needs with a single review point for the set of needs assessments. Following feedback from stakeholders, the Long Term RFI step was replaced with the Long Term RFP. Brackets were also placed over parts of the process that would be reviewed by the TAP and the Independent Observer.

Figure H- 4: Sourcing Diagram Presented on December 9, 2019



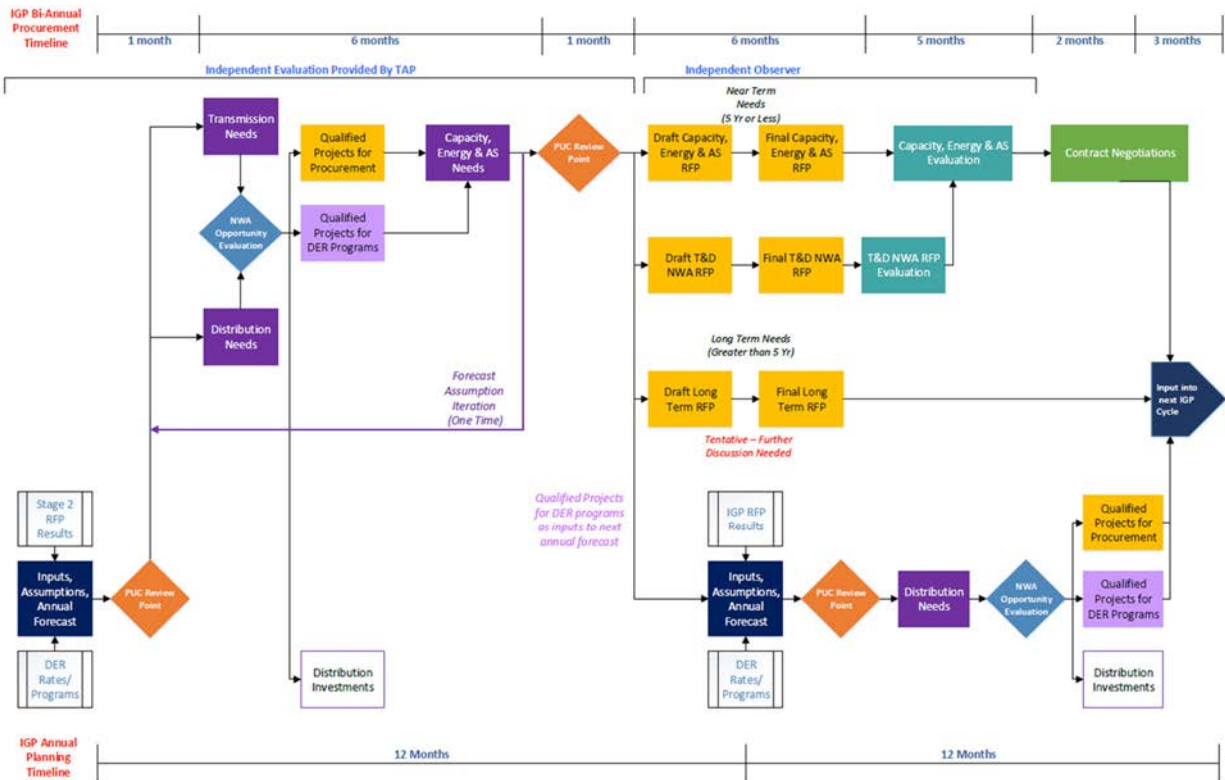
On January 23, 2020, a one-time iteration of the sales forecast was added into the process based on stakeholder feedback to provide one round of iteration of the assumptions. The sourcing diagram was also revised to show the distribution needs assessment occurring on an annual basis.

Figure H- 5: Sourcing Diagram Presented on January 23, 2020



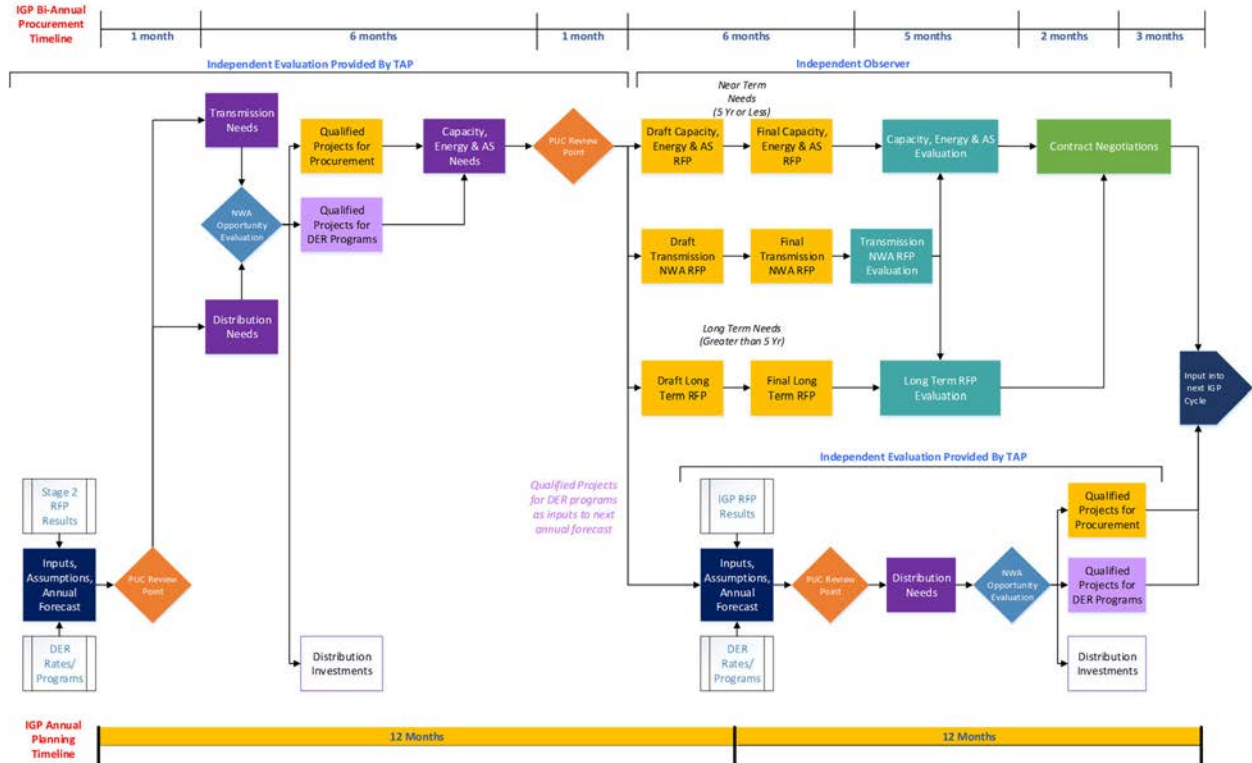
On February 12, 2020, the process step to “Develop 5-year Plan” was removed to emphasize that the needs assessment will provide transmission needs, distribution needs, and capacity, energy and ancillary service needs over the entire planning horizon and not just the next five years.

Figure H- 6: Sourcing Diagram Presented on February 12, 2020



On March 16, 2020, the independent evaluation by the TAP was clarified to also include the distribution needs and NWA opportunity evaluation that occurs in the second year of the IGP cycle. Following several working group meeting discussions in the SEOWG and FAWG, the forecast iteration was removed as the forecasts and other assumptions would be stress tested through sensitivity analyses proposed by stakeholders using RESOLVE as described in Figure H- 7.

Figure H- 7: Sourcing Diagram Presented on March 16, 2020



# Appendix I. Distribution Planning Methodology

---

## I.1. INTRODUCTION AND BACKGROUND

As it strives to provide 100 percent renewable energy by 2045, Hawaiian Electric (Company) faces an unprecedented situation: a comprehensive transformation of its five electric power grids. Attaining the state's renewable energy goals represents uncharted territory for both short-term and long-term resource planning. Performing the analyses necessary to attain this goal is a complicated resource planning process, requiring new tools and new processes: modeling across generation, transmission, distribution, infrastructure, and behind-the-meter resource options. This report describes the distribution planning methodology used to analyze the current state of the grid and its capability to meet future needs. Through this process, grid needs essential to support the transformation to a clean energy future are identified and solution options are explored.

The Company's distribution system is the part of its electric power system that distributes or disperses power to individual customers. The electrical distribution system (commonly referred to as the distribution grid) was originally planned and designed for the sole purpose of delivering electricity to customers from a small number of large power plants. In general, power flowed in only one direction, and it did not have to be flexible or adaptable—just strong and reliable.

Because centralized power plants have provided all of the power for its customers, the Company's traditional distribution planning methodology did not have to consider power generation. Instead, its methodology concentrated only on developing a distribution system that had the capacity to serve customers while maintaining power quality and a high level of reliability. Any deficiencies in the distribution system were solved by upgrades to the existing electrical system, including the installation of more substation transformers, more circuits, larger circuits, or larger distribution substation transformers.

Today, power plants can be found everywhere, connected to the distribution system in the form of privately owned rooftop solar systems, for example, that send power back onto the grid to serve other customers. The Company recognizes the potential and value of these distributed energy resources (DER) and agrees with the Commission's direction to "include the locational benefits of customer-sited distributed energy resources"<sup>80</sup> in the distribution planning process.

---

<sup>80</sup> HPU C Docket No. 2018-0055, Decision and Order No. 36288 Ka'aahi Substation, filed May 3, 2019, at 22.

As the power supply and electrical distribution systems transition to an integrated system, the planning processes must also transition. Hence today's distribution planning methodology must ensure the orderly expansion of the distribution system and fulfill the following core functions:

- Plan the distribution system's capability to serve new and future electrical load growth, including electric vehicle (EV) growth
- Safely interconnect DER, such as photovoltaic (PV) systems and energy storage systems that transmit power across the system in a two-way flow, while maintaining power quality and reliability for all customers
- Incorporate the locational benefits of DER in the evaluation of grid needs and system upgrades

The Company has engaged with customers and stakeholders to seek input and feedback on the distribution planning methodology as part of the Distribution Planning Working Group. This has afforded opportunities for stakeholders to collaborate and co-develop the Company's distribution planning methodology for identifying grid needs.

---

## I.2. SCOPE

The objective of this report is to describe the first three stages of the distribution planning process, particularly the planning methodology that will be used to identify distribution grid needs. The grid needs will be the foundation that drives solution options, including non-wires alternative (NWA) opportunities.

This report is a Distribution Planning Working Group deliverable as described in the Integrated Grid Planning (IGP) Workplan accepted by the Commission.<sup>81</sup>

---

<sup>81</sup> HPUC Order No. 36218, Accepting the IGP Workplan and Providing Guidance, Docket No. 2018-0165.

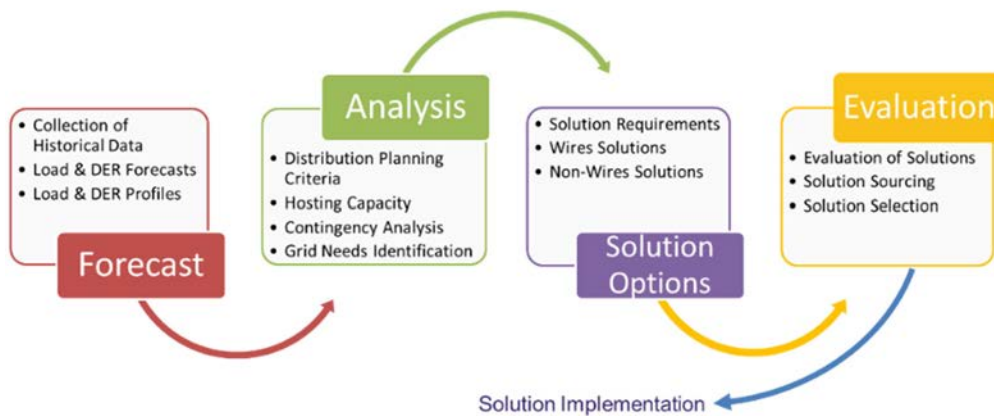


### I.3.DISTRIBUTION PLANNING PROCESS

#### I.3.1. OVERVIEW

The distribution planning process occurs annually and includes four stages: forecast, analysis, solution options, and evaluation (see Figure I-1). This report focuses on the first three stages, and the fourth stage is described in the *Non-Wires Opportunity Evaluation Methodology* report.<sup>82</sup>

Figure I- 1: Stages of the Distribution Planning Process



#### I.3.2. STAGES

The forecast stage begins at the start of the calendar year when the prior year’s data and corporate demand forecast are available for analysis (see Figure I- 2). LoadSEER, an integrated spatial load forecasting product developed by Integral Analytics, Inc., is used to create circuit- and transformer-level<sup>83</sup> forecasts.

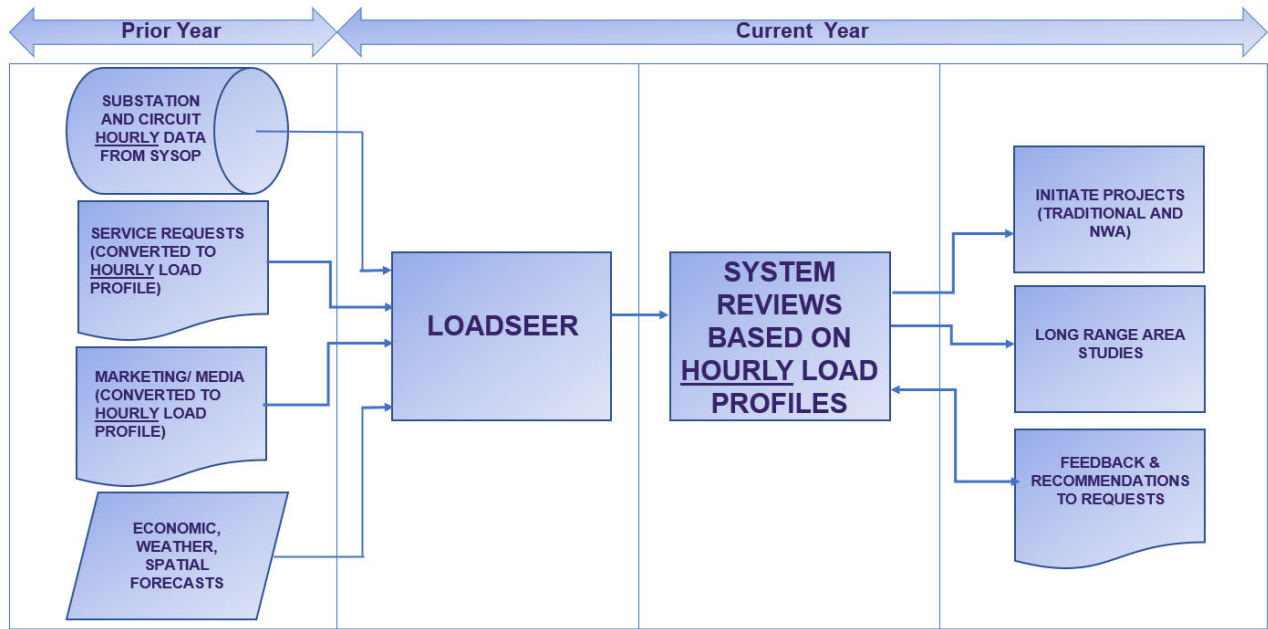
The analysis stage involves the analysis of the electrical system to ensure that there is adequate capacity and reliability (back-tie capabilities). Planning criteria have been established that provide the basis for determining the adequacy of the electric distribution system. In situations where the criteria are not met, grid needs are identified.

<sup>82</sup> Hawaiian Electric, *Non-Wires Opportunity Evaluation Methodology*, April 2020.

<sup>83</sup> Transformer – Unless stated otherwise, defined throughout document as substation transformer.

In the solution options stage, requirements to meet the grid needs are determined, and wires and non-wires options are developed. These options are evaluated in the fourth stage of the distribution planning process, which is discussed in the *Non-Wires Opportunity Evaluation Methodology* report.

Figure I- 2: Data from Prior Years used for Current Year Analysis



It is worth noting that during the calendar year, it is expected that new service requests or projects will arise that will require modifications to the circuit- and or transformer-level forecasts. The Company will, therefore, continually evaluate grid needs throughout the year and make decisions on when to address any grid deficiencies identified outside of the forecast and analysis stages.

---

## I.4. FORECAST STAGE

During the forecast stage of the distribution planning process, the Company develops a corporate demand forecast and uses LoadSEER to create circuit- and transformer-level forecasts.

### I.4.1. CORPORATE DEMAND FORECAST

The Company develops a corporate demand forecast<sup>84</sup> that will be used throughout the distribution planning process. This forecast is built with layers that include sales, DER, energy efficiency (EE), and EV. The corporate forecast is developed as an 8760 for the Company by layers. The 8760 is named for the number of data points it contains: one for every hour of every day of the year ( $24 \times 365 = 8760$ ). This will include DER (PV), battery energy storage system, EV, electric bus, and EE (8760 EE provided by the Applied Energy Group). For further information on the methodology of developing the corporate forecast, see the Integrated Grid Planning presentation by the Forecast Assumptions Working Group.<sup>85</sup>

### I.4.2. LOADSEER

LoadSEER is recognized as an industry-leading tool for use in forecasting and integrating DER with distribution planning.<sup>86</sup> LoadSEER has been adopted by the Company as a key component to advancing the distribution planning methodology. This electric load forecasting software uses the Company's corporate load forecasts and a multitude of other inputs to create forecasts at the circuit and transformer level.

The objective of LoadSEER is to statistically represent the geographic, economic, and weather diversity across a utility's service territory, and to use that information to forecast how circuit- and transformer-level hourly load profiles will change over the next 30 years. Because of the complexity of the forecasting challenge, LoadSEER employs multiple statistical methods, including hourly load modeling, macro-economic modeling, customer-level economic

---

<sup>84</sup> See

[https://www.hawaiianelectric.com/documents/clean\\_energy\\_hawaii/integrated\\_grid\\_planning/stakeholder\\_engagement/working\\_groups/forecast\\_assumptions/20210818\\_finaligp\\_inputs\\_and\\_assumptions.pdf](https://www.hawaiianelectric.com/documents/clean_energy_hawaii/integrated_grid_planning/stakeholder_engagement/working_groups/forecast_assumptions/20210818_finaligp_inputs_and_assumptions.pdf)

<sup>85</sup> Hawaiian Electric, Forecast Assumptions Working Group Meeting, July 17, 2019 (available at

[https://www.hawaiianelectric.com/documents/clean\\_energy\\_hawaii/integrated\\_grid\\_planning/stakeholder\\_engagement/working\\_groups/forecast\\_assumptions/20190717\\_wg\\_fa\\_meeting\\_presentation\\_materials.pdf](https://www.hawaiianelectric.com/documents/clean_energy_hawaii/integrated_grid_planning/stakeholder_engagement/working_groups/forecast_assumptions/20190717_wg_fa_meeting_presentation_materials.pdf)).

<sup>86</sup> See <https://www.utilitydive.com/news/how-leading-utilities-are-planning-for-distributed-energy-resources/516260/>.

modeling, and geospatial agent-based modeling, which taken together increase the validity and reduce uncertainty associated with the forecasts.

#### I.4.2.1. Circuit-Level Forecasts

The allocation of the forecasts to the circuit level is accomplished by integrating geospatial factors, historical data, historical and forecast weather, and customer billing information. This provides the granular data sets that are required to properly analyze the integration of increasingly dynamic DER.

LoadSEER employs familiar econometric forecasting methods at the circuit level and adds GIS-based spatial forecasting capabilities to aid in the identification of granular pockets of load growth, changes in loads, and load shape alterations that occur over time. Using these forecasting and modeling methodologies, LoadSEER is able to produce circuit-level new load, DER, EE, and EV forecasts.

#### I.4.2.2. Granular Data Sets

Traditionally, non-coincident peak loading was used in the distribution planning process. For instance, the peak load for a new service that was proposed to be energized in year X was added to the peak load forecast for year X to determine the new forecast. If the peak load for the new service did not occur at the same time as the peak load for the circuit or transformer, the resultant peak forecast may be overestimated.

The Company has recognized that this methodology does not properly evaluate the temporal nature of load and, in a similar manner, does not properly evaluate the effect of DER. By using LoadSEER, the annual circuit-level peak load has been replaced by an 8760 hourly load profile as the mechanism for forecasting future load. While traditional planning used one value to plan for a year, this methodology uses a large set of hourly profiles. LoadSEER can convert the large 8760 load profile to a more manageable 576 load profile. The latter profile is composed of a weekday and weekend profile per month [(weekday 24 hours + weekend 24 hours) x 12 months].

#### I.4.2.3. Forecasting Tools

A component of LoadSEER is SCADA Scrubber (see Figure I- 3). This tool takes the hourly data and analyzes it for trends, which the tool then uses to normalize periods where planned maintenance or system interruptions occurred.

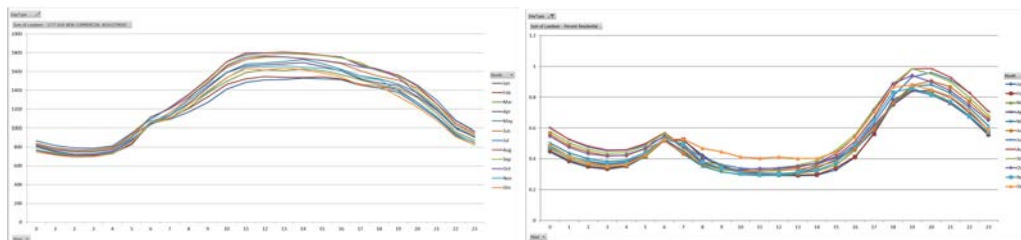
Figure I- 3: LoadSEER SCADA Scrubber Screenshot



After the data has been “cleaned,” 8760 and 576 profiles based on actual data are available to determine the historical peak load and to provide profiles for future year forecasts.

New load requests, DER requests, and marketing and media information of new developments that have been received in the past calendar year are used to refine the forecasts at the circuit and transformer level. Normally, customers who submit new service requests to the Company provide only a peak load estimate and a rough in-service date. As such, LoadSEER has default commercial and residential load profile shapes that are based on the Company’s actual commercial and residential load profiles, respectively (see Figure I- 4). The Company is continuing to explore ways to work with large real estate developers to gain better insight and local knowledge to inform load forecasts, such as, to the extent possible, requiring developers to provide expected load profiles of their developments rather than just a peak megawatt load increase. The Company intends to use additional sensing data as it becomes available to develop customer class profiles by type or sector, which will improve the accuracy of the load forecasts.

Figure I- 4: Scalable Commercial and Residential Profiles

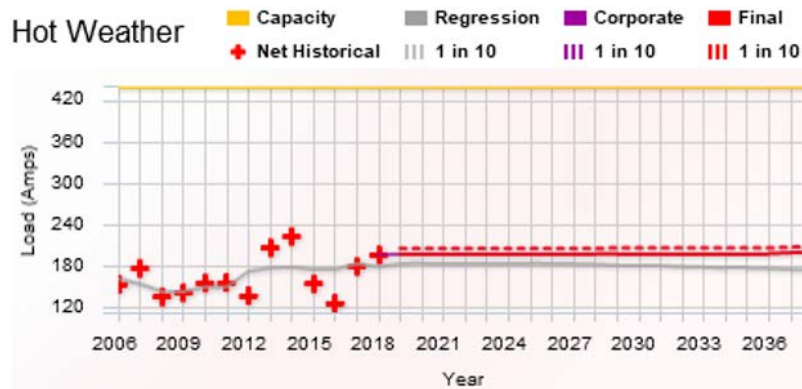


These default profiles are used to scale the peak load estimates for the new developments to create a proxy load profile. Similarly, a load profile of an existing, comparable customer could be used in this manner. This local knowledge is a key component because it generally has the greatest impact on circuit-level forecasts.

LoadSEER also has tools to apply various scenarios to the forecasts. For instance, a range of forecasts can be applied to DER, EV, and EE layers to plan for their inherent uncertain nature.

In addition, tools are available to further modify the circuit- and transformer-level forecasts by using regression analysis or econometric variables, or a blending of these two methodologies. An example of a feeder forecast is shown in Figure I- 5.<sup>87</sup>

Figure I- 5: Example LoadSEER Circuit Forecast



<sup>87</sup> The risk level associated with the forecasts filed in the Company's *Location-Based Distribution Forecasts* document to be filed November 2021 in Dkt. No. 2018-0165 is 1 in 100.

---

## I.5. ANALYSIS STAGE

During the analysis stage of the distribution planning process the Company uses various tools, such as Synergi and LoadSEER, to analyze the grid conditions and forecasts against the distribution planning criteria to determine the adequacy of the electric distribution system. In addition, the Company assesses DER hosting capacity, conducts a contingency analysis, and identifies grid needs.

### I.5.1. DISTRIBUTION PLANNING CRITERIA

Distribution planning criteria have been established as technical guidelines to ensure that the distribution system has adequate capacity and reliability for the Company's customers. Hence the distribution system is planned and designed to operate under both normal and contingency conditions. In addition, it is important to consider normal and contingency overloads, and thermal and voltage issues.

#### I.5.1.1. Normal Conditions

The distribution system, or a subset of the distribution system, is operating under normal conditions when all circuits and transformers in the subject area are configured as designed. Under this normal condition, the circuits and transformers are planned to have adequate capacity to serve electrical peak load, and with DER, the circuits and transformers are also planned to be adequate for the backflow of generation caused by the DER.

#### I.5.1.2. Contingency Conditions

The distribution system, or a subset of the distribution system, is operating under contingency conditions when a single circuit or transformer is out of service. This is also referred to as an N-1 scenario. A circuit or transformer may be out of service or de-energized because of equipment failure or planned maintenance. As such, a level of capacity must be available on the circuits and transformers to be available to serve the Company's customers during these N-1 scenarios. For instance, because an adjacent circuit or transformer is often used as a backup source for another circuit or transformer, N-1 scenarios also need to be analyzed to ensure that back-tie capacity is available.

### I.5.1.3. Normal and Contingency Overloads

Normal overload occurs when the load exceeds the normal equipment rating of distribution circuits or distribution substation transformers under normal operating conditions. Normal overload is identified by comparing the forecasted load with the equipment rating.

Contingency overload occurs when the load exceeds the emergency equipment ratings of a piece of equipment due to other equipment failure or other equipment being out for maintenance. Contingency overload is identified by studying the forecasted load for possible contingency situations.

### I.5.1.4. Thermal and Voltage Issues

The overload of a circuit or transformer may lead to overheating issues that will damage equipment; hence, overloads are considered thermal issues. In addition to thermal overloads, the Company also ensures that there are no voltage issues. In general, the voltage level must be maintained within 5 percent of the nominal voltage at any point on the distribution system (primary and secondary).

When circuit or transformer loading exceeds the equipment thermal ratings, damage may occur to the equipment. This damage may lead to extended service interruptions and high maintenance expenses. Low or high voltage may lead to power quality issues that could damage customer-owned equipment or cause nuisance electrical issues, such as flickering light or tripping of equipment.

## I.5.2. EQUIPMENT THERMAL RATINGS

Distribution circuit thermal ratings are primarily based on the following factors:

- Conductor size
- Conductor material
- Number of conductors in a duct bank (underground construction)
- Temperature
- Type of insulation
- Conductor configuration

Distribution substation transformer thermal ratings for normal and contingency conditions are primarily based on the following factors:

- Expected hourly loading
- Oil and ambient temperature



- Allowable insulation degradation (loss-of-life limits)
  - A 0 percent loss-of-life factor is the basis for the normal transformer rating.
  - A 1 percent loss-of-life factor is the basis for the emergency rating.

### I.5.3. GRID ANALYSIS AND MODELING

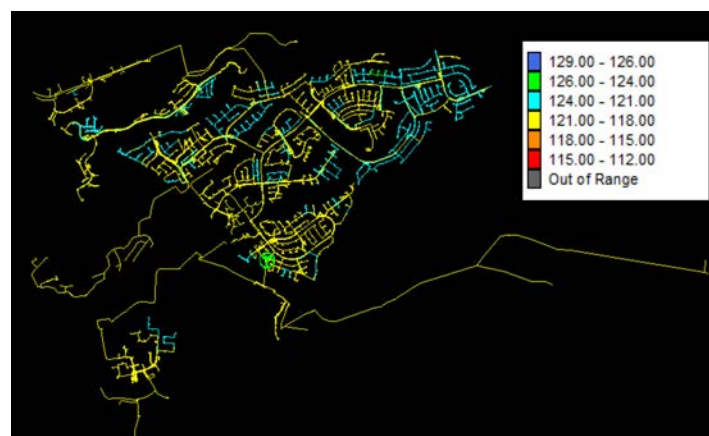
Analysis is necessary to identify any violations of the distribution planning criteria. The load forecasts are analyzed under normal and contingency operating conditions to determine the location, cause, and severity of any unacceptable thermal or voltage situations.

Simulations of the various normal and contingency operating conditions are analyzed using LoadSEER as well as Synergi, which is a load flow software developed by DNV-GL. By using LoadSEER and Synergi in concert, the Company determines any existing or forecasted grid needs. Both software products also facilitate the development of solution options for the identified issues.

### I.5.4. DER HOSTING CAPACITY

During the analysis stage, DER hosting capacity is assessed to determine any future grid needs required to create capacity for future DER. In general, the hosting capacity analysis involves the use of Synergi circuit models where DER growth is simulated to determine the maximum amount a circuit can host before any thermal or voltage violations occur. The loadflow capabilities of Synergi provide information on the location and magnitude of these issues (see Figure I- 6)<sup>88</sup>.

Figure I- 6: Synergi Screenshot



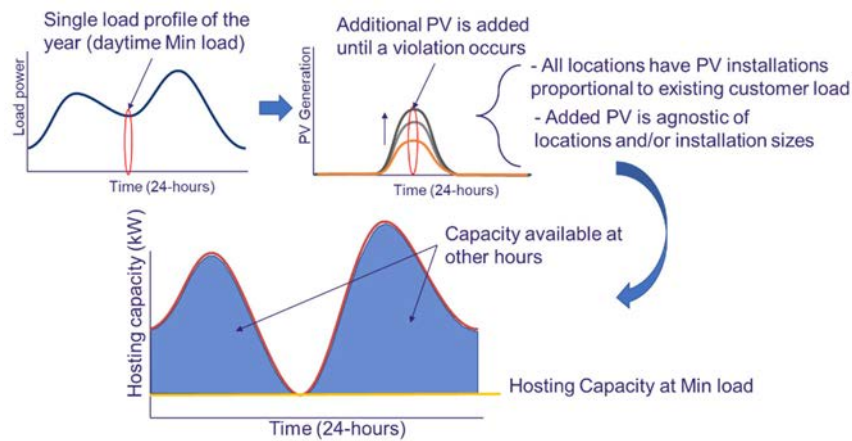
<sup>88</sup> Additional information related to the process is provided in the Company's *Distribution DER Hosting Capacity Grid Needs* document to be filed November 2021 in Dkt. No. 2018-0165.

### I.5.4.1. Existing Hosting Capacity Methodology

Figure I- 7 illustrates the existing hosting capacity methodology. With today’s methodology, DER is added to a circuit according to the location of current DER applicants, and those amounts are grown until a violation occurs. Any violation is a potential grid need.

As illustrated, this methodology uses only a single, minimum load profile and does not consider the capacity available during all other hours. Although this does not account for the temporal nature of solar output, this single hosting capacity figure still provides valuable screening thresholds to help determine the circuit’s ability to accommodate additional DER without the need for in-depth analysis. If the circuit has reached or exceeded its hosting capacity threshold, then any new DER will require more advanced studying until system changes warrant the development of a new hosting capacity threshold.

Figure I- 7: Existing Hosting Capacity Methodology



### I.5.4.2. Future Hosting Capacity Methodology

The Company is updating the existing methodology to account for the hosting capacity available during all hours. This can be accomplished only by using time-sensitive profiles of the unique DER programs as well as the modeling of advanced inverters in a time-series analysis. Furthermore, because there are many ways that DER can develop on a feeder, multiple DER growth scenarios need to be studied, applying probabilistic modeling techniques and analysis. A comparison of the existing hosting capacity with the future hosting capacity analysis is shown in Table I - 1.

Table I – 1: Future Hosting Capacity Enhancements

	Current HECO HC analysis	Future HECO HC analysis
Model Unique DER Programs (Non-Export & Smart Export)	x	✓
Advanced Inverter (VV/VW)	x	✓
Time Series (576/8760)	x	✓
Probabilistic model	x	✓
Add PV in realistic installation sizes	x	✓
Add PV in locations that make sense	x	✓

The Company is working with Electric Power Research Institute (EPRI) to refine the hosting capacity analysis.<sup>89</sup> The methodology is scheduled to be developed by the second quarter of 2020. The new DER hosting capacity methodology will be implemented in the distribution needs assessment as part of the transmission and distribution needs assessment step of IGP.

The updated hosting capacity methodology being developed with EPRI incorporates several new aspects to determine an hourly circuit hosting capacity profile. The assessment considers the effects of smart inverter functions and the temporal load characteristics of the different Company programs, such as smart-export systems, non-export systems, and storage profiles via time-based analysis. The Company is seeking data from solar installers to help inform the generation output model for these systems.

The updated methodology plans to use circuit-level forecasts (for example, circuit load shapes and future DER growth) that are generated from LoadSEER. The Company will use a 576-hour time-series model format that corresponds to 24-hour observations for 24 days. Typically, this represents 2 days for each month. These 2 days are either the peak/minimum load days or the weekday/weekend days of the months. Alternatively, the profile can be expanded to include as many hours as desired, such as a full 8760-hour profile representing all 365 days of the year at a 1-hour resolution.

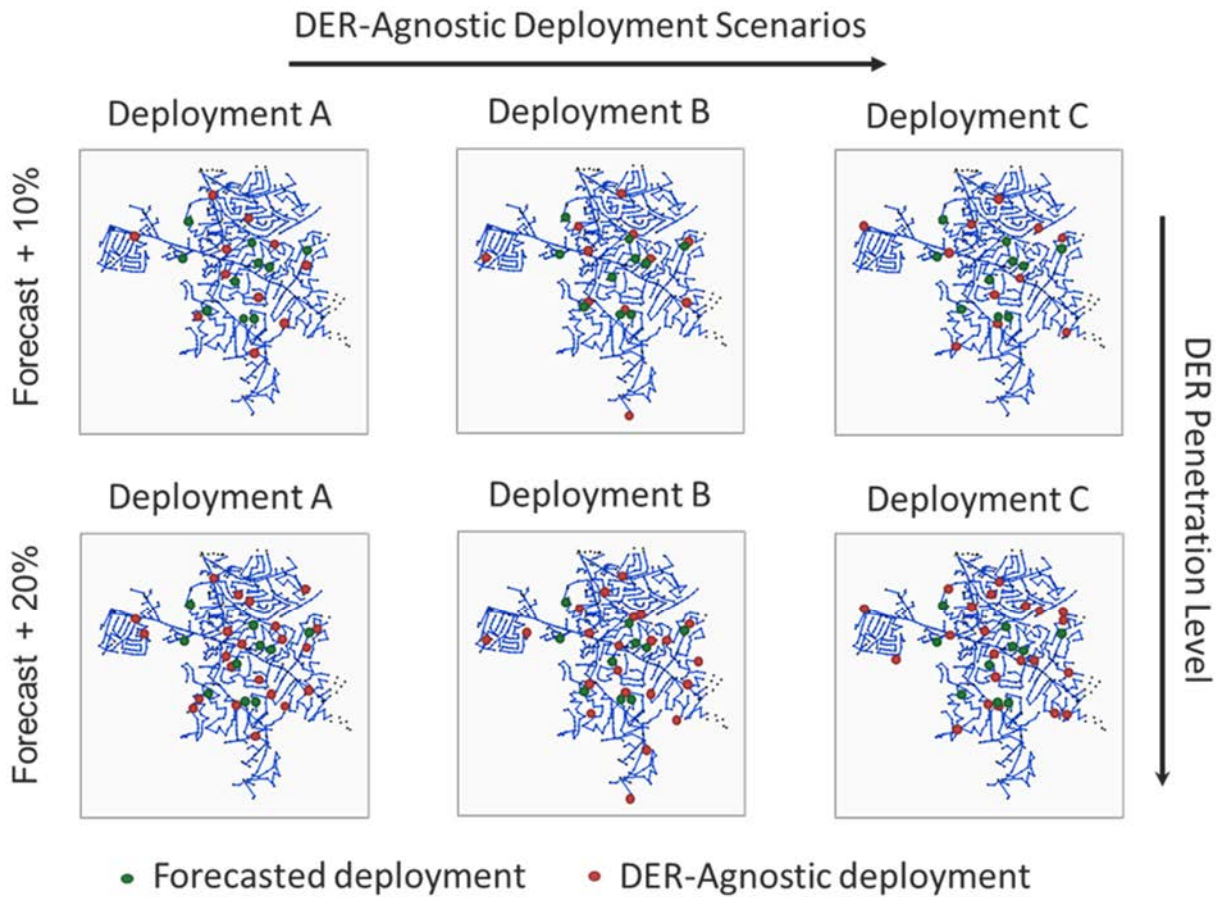
An additional enhancement is the modeling of future DER deployments. Incorporating user input, the addition of future DER will be modeled in a more realistic manner. The size of each new residential DER is randomly chosen between the bounds defined by the user, allowing flexibility to preserve the prevalent DER size belonging to circuits in unique areas. The user also defines the threshold to identify either a commercial or residential load type. The DER is then sized according to the load type it is connected to. The size and location of future DER installations are normally unknown variables in hosting capacity analysis. Unlike the existing hosting capacity methodology, which simply scaled up existing DER

<sup>89</sup> Hawaiian Electric, Distribution Planning Working Group Meeting, November 18, 2019 (available at [https://www.hawaiianelectric.com/documents/clean\\_energy\\_hawaii/integrated\\_grid\\_planning/stakeholder\\_engagement/working\\_groups/distribution\\_planning/20191204\\_dpwg\\_meeting\\_presentation\\_materials.pdf](https://www.hawaiianelectric.com/documents/clean_energy_hawaii/integrated_grid_planning/stakeholder_engagement/working_groups/distribution_planning/20191204_dpwg_meeting_presentation_materials.pdf)).

installations to represent DER growth, the new methodology explores multiple scenarios where DER deployments of different sizes and locations are added to the model to develop a probabilistic hosting capacity. Traditionally, hosting capacity is set by the first DER scenario, causing the first bus/element to have a violation at any instance in time. Probabilistic hosting capacity, on the other hand, allows one to consider additional hours, buses, and/or DER deployments beyond the first violation before the hosting capacity is determined.

The hosting capacity assessment is performed in three primary steps: base case, forecasted DER, and agnostic DER. The base case assessment analyzes the existing circuit conditions for the year. The forecasted DER assessment explores multiple scenarios of adding new DER deployments onto the circuit, totaling the forecasted DER amount for the year of study. The generation profile for the forecasted DER deployments is a function of the DER size, program type, and solar irradiance for the area. Finally, the agnostic DER assessment adds agnostic DER deployments on top of the forecasted DER assessment. Full generation output is considered from each agnostic DER at each hour because it is not known how or when that resource would be online (such as solar plus storage projects), thus providing circuit impact results agnostic to future DER type. The order by which the agnostic DER is allocated is cumulatively split into a number of penetration levels that are independently analyzed so that the impacts from the additional agnostic DER can inform hosting capacity. More penetration levels can be analyzed and will effectively produce finer resolution hosting capacity results because the maximum agnostic DER penetration level scenario is always based on full feeder saturation where all customers have DER. Figure I- 8 illustrates two penetration levels out of ten, which would take the feeder to 100 percent customer penetration.

Figure I- 8: Forecasted and Agnostic DER Deployment Scenarios



After each simulation, power flow data is captured to quantify impacts. This data is used to process the probabilistic hosting capacity depending on time, breadth of the violation, and number of agnostic DER deployments indicating violation. Therefore, the probabilistic hosting capacity is dependent on the number of violated hours, the number of violated locations, and the number of agnostic DER deployments experiencing a violation. In planning studies with so many variables, these probabilistic metrics are more beneficial than planning for the worst-case scenario. The worst-case scenario would identify when the first sampled condition experiences a violation, but it also has the lowest chance of occurrence/risk. The probabilistic hosting capacity allows one to identify a more likely chance of occurrence with slightly increased risk. For example, if the probabilistic hosting capacity is based on 10 percent of the sampled conditions experiencing a violation, the amount of DER that can be accommodated is greater than the conservative worst-case scenario. In this example, this probabilistic hosting capacity defines that 10 percent of the sampled conditions could not accommodate more DER due to more adverse violation, whereas 90 percent of the sampled conditions could still accommodate more DER. The analysis illustrated in Figure I- 9 shows the frequency of hosting capacity of a circuit throughout the hours in a day. Figure I- 10 is the associated color index.

Figure I- 9: Daily Hosting Capacity Profile

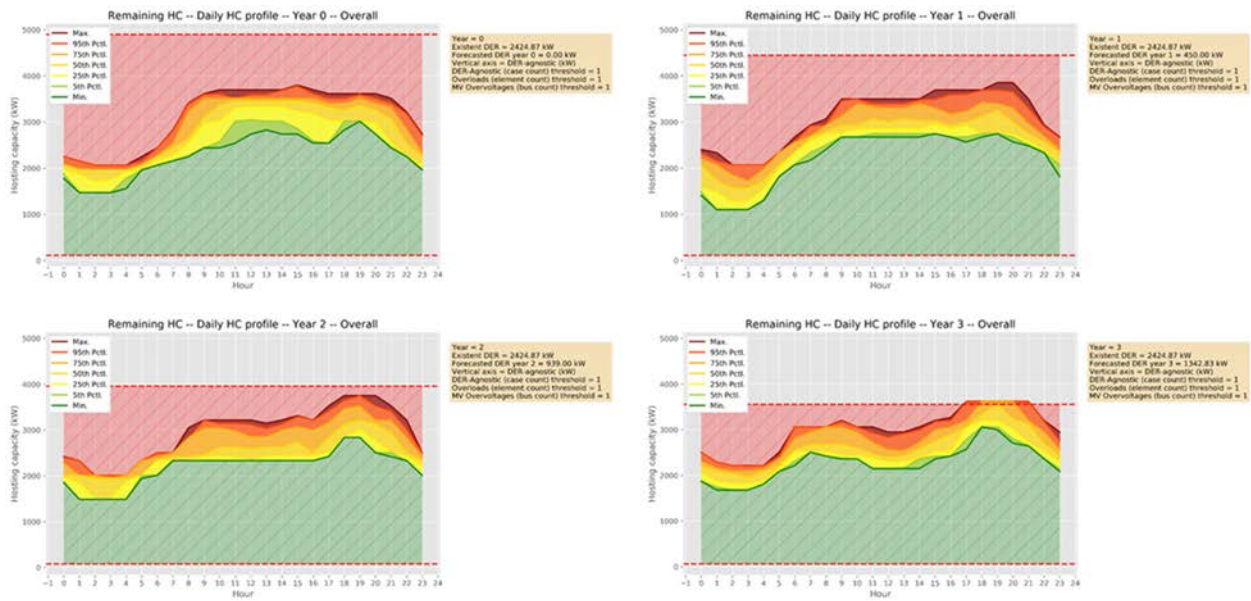
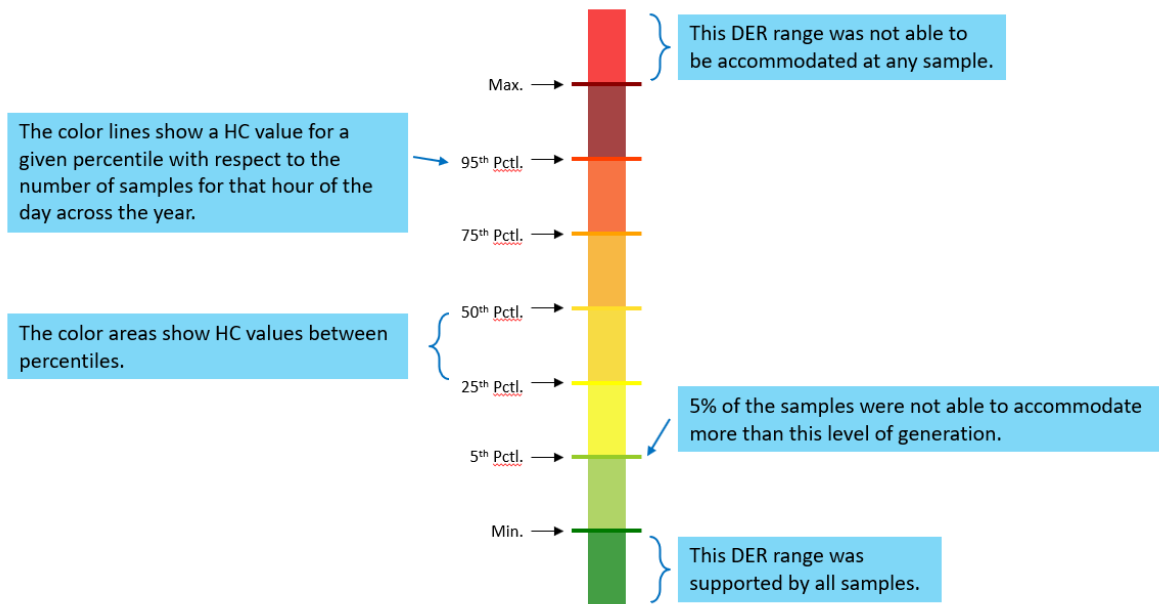


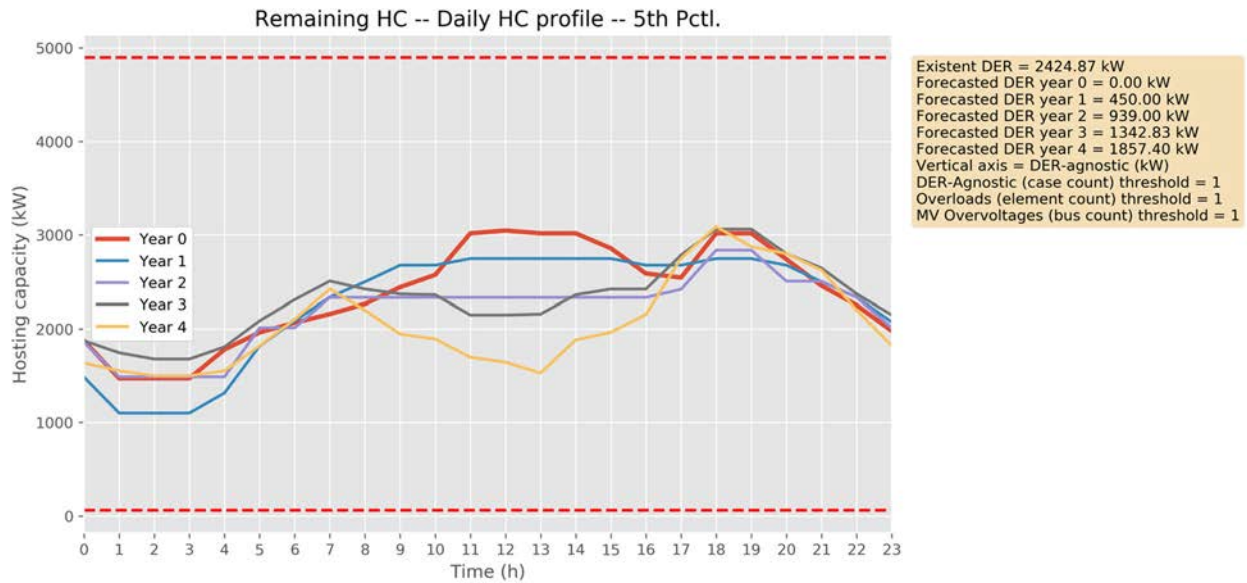
Figure I- 10: Daily Hosting Capacity Color Code





In the example shown in Figure I- 11, the results of a probabilistic analysis of the fifth percentile shows the daily hosting capacity available forecasted over multiple years on a circuit.

Figure I- 11: Example Daily Percentile-Specific Hosting Capacity Result



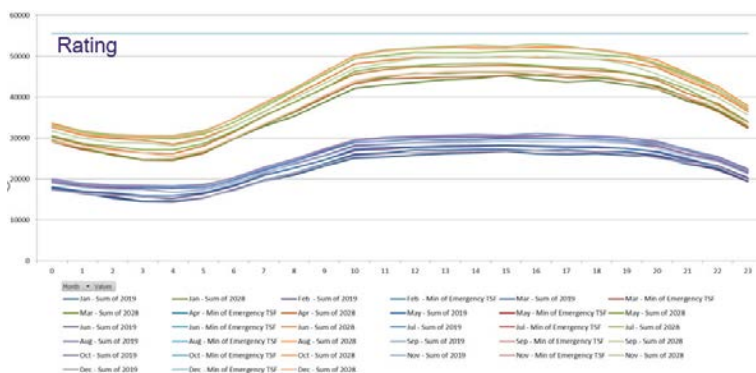
Overall, the Company’s updated hosting capacity methodology will be a time-based analysis that takes into consideration the Company’s unique programs, the impact of advanced inverter functions, and the two key variables of DER deployment—size and location—that form the core structure for a probabilistic analysis. By considering these new variables, it is expected that the methodology will produce less conservative and more realistic hosting capacity results. The updated methodology is performed in three steps that each provide different objectives: (1) the base case assessment to identify any underlying conditions on the feeder; (2) the forecasted DER assessment to identify underlying conditions due to the DER forecast; and (3) the agnostic DER assessment to identify the remaining hosting capacity. Separating these steps helps the analysis incorporate the information from the Company’s forecasting tool and inform its future grid needs assessments.

### 1.5.5. CONTINGENCY ANALYSIS

For the Company circuits and transformers, LoadSEER produces 576-hour profiles for both normal and contingency (N-1) cases. Furthermore, new developments that have a direct impact on the circuits or transformers that are being analyzed can be added to the profiles created for the various cases.

Figure I- 12 shows an example of a contingency analysis using the hourly profile from LoadSEER. The darker group of lines represent the forecast loading on a distribution substation transformer for a peak day per month when an adjacent distribution substation transformer fails. The lighter group of lines represents the forecast loading if new large services are energized in the area. The example shows that the forecast for this N-1 scenario does not cause a thermal rating violation.

Figure I- 12: N-1 Example



### 1.5.6. PLANNING CRITERIA VIOLATION

The analysis stage of the distribution planning process should identify existing or forecasted thermal or voltage issues on the Company’s circuits and substation transformers. Issues may also be identified through data provided directly by devices installed throughout the Company’s system that record voltage and current. These devices include advanced meters and OptaNode Grid2020 units. Advanced meters are being strategically deployed throughout the Company’s service area and the data can be used to monitor power quality to those customers. OptaNode Grid2020 are also devices that gather power quality data, similar to an advanced meter, but at the distribution transformer.

Regardless of the manner in which an issue is identified, any situation where planning criteria are violated will need further review to determine the grid needs and the associated solution options.

### 1.5.7. GRID NEEDS IDENTIFICATION

To identify grid needs, the Company develops a demand forecast, a demand forecast by load type, a grid needs assessment, and an hourly grid needs summary, as discussed in the following sections.



### I.5.7.1. Demand Forecast

As part of the distribution grid needs documentation,<sup>90</sup> the Company will submit a demand forecast that will list the grid assets and show the net peak forecast (including DER layers) for these assets over the next 5 years. The data to be provided for this demand forecast is described in Table I - 2.

Table I - 2: Demand Forecast

Specification	Definition
Facility type	Circuit or transformer
Facility name	Circuit or transformer identifier
Equipment rating (MW)	Equipment's rated capacity
Year XXXX peak load (MW)	Peak load forecast for year XXXX
Year XXXX+1 peak load (MW)	Peak load forecast for year XXXX+1
Year XXXX+2 peak load (MW)	Peak load forecast for year XXXX+2
Year XXXX+3 peak load (MW)	Peak load forecast for year XXXX+3
Year XXXX+4 peak load (MW)	Peak load forecast for year XXXX+4

### I.5.7.2. Demand Forecast By Load Type

The Company will submit a demand forecast by circuit by load type per year (5 years of forecasts). The data that will be included is described in Table I - 3.

Table I - 3: Demand Forecast by Load Type

Specification	Definition
Circuit name	Circuit identifier
Year XXXX residential load (MW)	Residential load forecast for year XXXX
Year XXXX commercial load (MW)	Commercial load forecast for year XXXX
Year XXXX EV	EV load forecast for year XXXX
Year XXXX DER	DER load forecast for year XXXX
Year XXXX EE	EE load forecast for year XXXX

### I.5.7.3. Grid Needs Assessment

A grid needs assessment will be performed to identify situations where planning criteria are violated based on the per circuit or transformer forecasted net demand described in Section 4.7.1. In addition, a traditional solution will be defined for each grid need identified, as

<sup>90</sup> IGP Workplan at 26 (available at [https://www.hawaiianelectric.com/documents/clean\\_energy\\_hawaii/integrated\\_grid\\_planning/dkt\\_20180165\\_20181214\\_igp\\_workplan.pdf](https://www.hawaiianelectric.com/documents/clean_energy_hawaii/integrated_grid_planning/dkt_20180165_20181214_igp_workplan.pdf)).

discussed in Section 6, Solution Options. The data that will be included in the grid needs assessment is described in Table I - 4.

Table I - 4: Grid Needs Assessment

Specification	Definition
Substation	Transformer asset identification
Circuit	Feeder asset identification
Distribution service required	Distribution capacity or distribution reliability (back-tie) service
Primary driver of grid need	Whether the identified grid need is primarily driven by DER growth, demand growth, other factor(s), or a combination of factors
Operating date	The date at which traditional infrastructure must be constructed and energized in advance of the forecasted grid need to maintain safety and reliability
Equipment rating (MW)	Equipment's rated capacity
Peak load (MW)	Peak loading on asset for given year
Deficiency (%)	Deficiency divided by the rating for each of the forecasted years
Traditional solution	Traditional solution identified, as discussed in Section 6, Solution Options
NWA qualified opportunity	Whether the grid need is a qualified opportunity for further evaluation based on technical requirements and timing of need

Note: A qualified opportunity has passed "Step 1" as outlined in the *Non-Wires Opportunity Evaluation Methodology* report and will proceed to "Step 2," where it will be further analyzed and prioritized.<sup>91</sup>

#### 1.5.7.4. Hourly Grid Needs Summary

For the grid needs determined to be qualified opportunities, solution requirements will be defined in technology-neutral terms, such as the amounts of energy, time(s) of day, and days of the year. This hourly grid needs summary will be provided as described in Table I - 5.

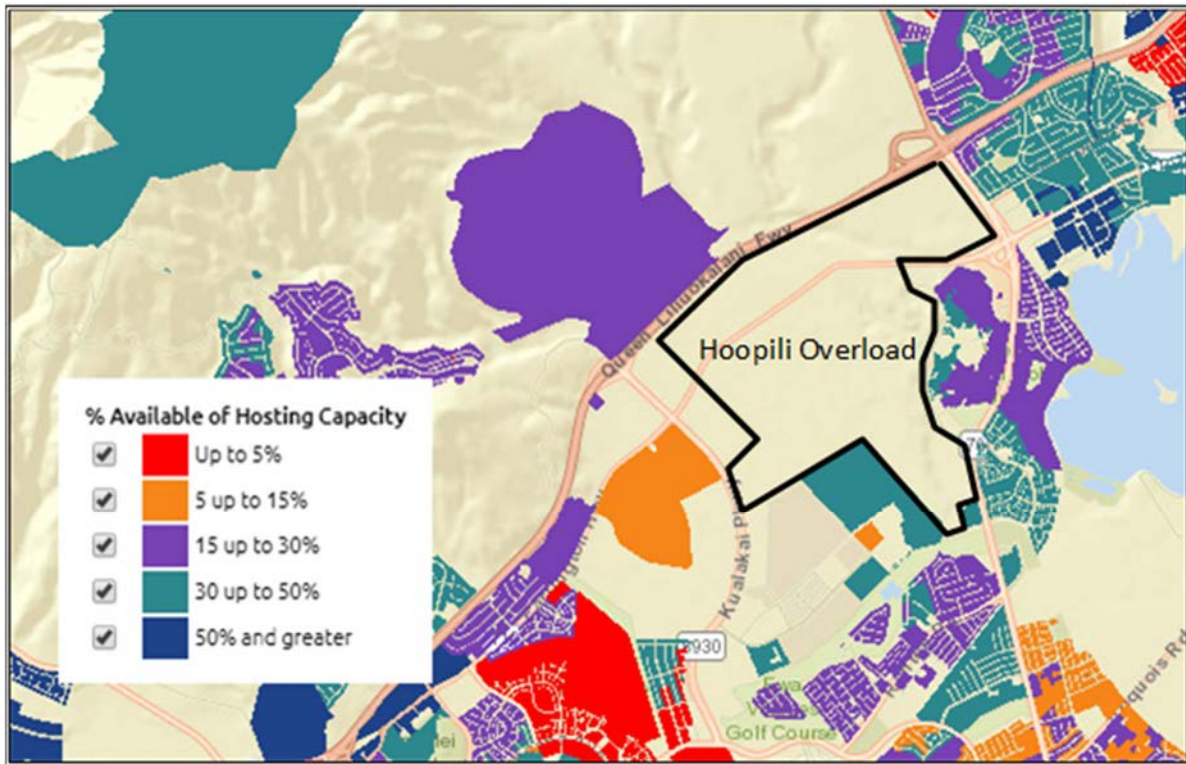
Table I - 5: Hourly Grid Needs Summary

Specification	Definition
Substation	Transformer asset identification
Circuit	Feeder asset identification
Capacity (MW)	Amount of power required to mitigate the grid need
Energy (MWH)	Amount of energy required to mitigate the grid need
Delivery time frame	Months/hours when the planning criteria violations occur
Duration (hours)	Length of time of the grid need
Maximum number of calls per year	Maximum number of days in the year requiring mitigation

<sup>91</sup> Hawaiian Electric, *Non-Wires Opportunity Evaluation Methodology*, April 2020, Section 4.

During the NWA opportunity evaluation, as outlined in the *Non-Wires Opportunity Evaluation Methodology* report, each NWA opportunity assigned to Transmission and Distribution Action Plan Track 1 or Track 2 will have an associated map of the general area of need overlaid with available hosting capacity. An example of this integrated map for the Ho'opili area is provided in Figure I- 13.

Figure I- 13: Integrated Grid Needs Map Example



---

## I.6. SOLUTION OPTIONS STAGE

During the solution options stage of the distribution planning process, the Company determines solution requirements and develops wires and non-wires solution options.

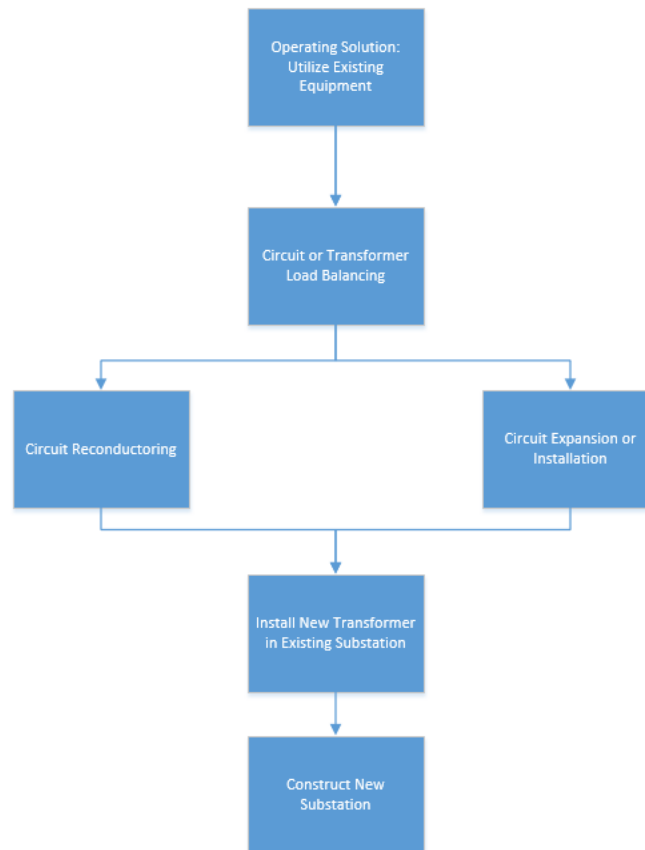
### I.6.1. SOLUTION REQUIREMENTS

An identified grid need is the foundation of a solution's requirements. There may be other requirements, including some unique to the specific opportunity, that will provide additional constraints that solution options must meet. Examples of additional requirements may include a minimum level of reliability or physical/economic constraints. While factoring the solution requirements, a project scope for solution options will be developed that may involve the creation of work plans, such as planning single-line diagrams for wires solutions or time-based capacity requirements for non-wires solutions.

### I.6.2. WIRES SOLUTION DEVELOPMENT PROCESS

Creating a cost effective, valid solution is a very complex and iterative process. In general, the more complex the solution, the more expensive the solution. When the Company develops the scope of a wires solution, the simplest solution is usually considered first, followed by solutions of increasing complexity. During the development of a mitigation, possible solutions are created and analyzed for the capability of solving the shortfall where consideration of the cost and ongoing maintenance is the most significant consideration in comparing varying solutions. In many situations the studied solution is inadequate and another potential solution is analyzed. This iterative solutions analyses process occurs until probable solution options of the lowest complexity are exhausted, in which case the next set of complex solutions are added to the solutions options. Having historical and forecasted knowledge of the area or equipment are invaluable in eliminating solution options with a high probability of failure. Once a solution is identified that fulfills the grid need, any additional, more costly solutions will not be analyzed. LoadSEER or Synergi, or both, will be used to analyze the solutions. The general process flow is shown in Figure I- 14.

Figure I- 14: Wires Solution Development Steps



Once the least complex solution is identified, a project scope is typically developed in the form of a planning single-line diagram. This diagram is a sketch that provides sufficient information for design engineers to develop a project scope and cost estimates, and if necessary, to provide the guidance to develop drawings and specifications used by construction personnel to execute the work. The project scope and cost estimates will inform the avoided cost that will be used in the NWA screen and will be evaluated as described in the *Non-Wires Opportunity Evaluation Methodology* report.

#### I.6.2.1. Operating Solution: Use Existing Equipment

It is possible that a particular grid need can be satisfied by a simple reconfiguration of the existing distribution system. For instance, existing switches could be operated to resolve overload conditions, and the recalibration of the settings for existing voltage regulation devices could be employed to increase hosting capacity.

In this solution scenario, no cost estimates would be developed, and the Company would proceed without any further wires or non-wires analysis.

### I.6.2.2. Circuit or Transformer Load Balancing

If the existing electrical system cannot be simply reconfigured using existing equipment, the next type of solutions to be analyzed involves circuit or transformer load balancing. Load balancing can often resolve capacity issues. For instance, new switches may be installed on existing overhead circuits to provide circuit sectionalization to balance circuit loading (that is, reduce capacity on one circuit but increase capacity on another). Also, taps on overhead circuits could be cut and tapped elsewhere to change the configuration and loading on circuits. Similarly, cuts and taps (new splices) can be made in manholes of existing underground distribution systems to balance underground cable loading.

The taps of individual distribution transformers could also be modified to balance the loading among the three electrical phases. This type of balancing is referred to as phase balancing and is a method that can increase hosting capacity.

### I.6.2.3. Circuit Reconductoring or Circuit Expansion/Installation

The next type of solutions, in terms of complexity and cost, to be analyzed involve upgrades to the distribution circuits. One type of upgrade is the reconductoring of existing overhead conductors or underground cables. In general, this involves the removal and replacement of the existing lines with larger-sized lines. This will directly increase the available capacity on the circuit.

For overhead systems, it may not only involve changing the conductors but also may require installation of new poles because the existing poles may not be strong enough to carry the weight of the larger-sized conductors. Similarly, for underground systems, the existing underground infrastructure (handholes, manholes, conduits) may not be large enough to accommodate physically larger-sized cables. Therefore, reconductoring of underground cables may also involve installation of new underground infrastructure.

Another type of upgrade on a distribution circuit involves the expansion of the circuit. In this situation, new overhead conductors or underground cables are installed where existing equipment does not exist. For instance, a new pole-line consisting of new wires and new poles may be constructed between two existing circuits to create back-tie capacity. For underground systems, new cables can be installed in existing spare conduits to create new underground ties or to balance underground circuits.

Circuit reconductoring and circuit expansion are considered in parallel because the complexity and, therefore, the cost is highly dependent on physical conditions. For example, for the same physical distance, reconductoring is typically cheaper than new construction. However, if reconductoring involves changes in the existing infrastructure, as noted previously, new construction could potentially be less complex to execute and more cost effective.

#### I.6.2.4. New Transformer in Existing Substation

The Company's substations are typically designed to accommodate more than one substation transformer. If grid needs cannot be fulfilled with distribution circuit line work, the next solution option is to analyze installation of new transformers at existing substations. This solution involves the installation of a new substation transformer and associated circuits.

#### I.6.2.5. New Substation

The last wires solution to analyze is the construction of a new substation.

### I.6.3. NON-WIRES SOLUTION OPTIONS EXAMPLES

The following sections are some examples of non-wires solution options that could be utilized to mitigate a grid need.

#### I.6.3.1. Distributed Energy Resources

DERs such as distributed renewable generation and energy storage, can be a potential NWA option to solve a grid need. In situations such as thermal constraints, properly sized and sited DERs could eliminate or defer overloading due to load or DER production by injecting or absorbing power as needed to mitigate violation concerns. NWA options include both utility-scale and behind-the-meter customer systems.

#### I.6.3.2. Energy Efficiency and Demand-Side Management (DSM)

Energy efficiency and DSM, such as conservation, curtailment, or reduction of energy use, may eliminate the grid need caused by thermal loading if the capacity demand causing the overloading is decreased below the rating of the equipment of concern. Similar to DERs, Energy efficiency and DSM, are location-specific NWA opportunities.

#### I.6.3.3. Power Electronics Devices

Power electronic devices, such as capacitors or dynamic secondary VAR controllers, have been used by the Company to manage areas with voltage issues. By having devices that can actively raise or lower voltage as needed, the overall voltage envelope experienced by the customer is

lessened. For example, the Company was able to utilize dynamic VAR controllers to level the voltage along a distribution circuit which increased the circuit hosting capacity to accommodate more DER.

#### I.6.3.4. Advanced Inverter Functionality

With the advancement of inverter technology, the Company has been able to leverage the increasing functionality to mitigate potential voltage issues caused by customer adoption of DER. For example, the advanced inverter functions volt-var and volt-watt can be used to mitigate voltage issues in lieu of secondary upgrade work..

#### I.6.4. CONTINGENCY PLANS AND SCHEDULE

The lead times to engineer and execute wires solutions is highly dependent on the required permitting and approvals. In general, the least complex solutions, as shown in Figure I- 14 and discussed in Section 7.2, have the shortest lead times. The following lead times will need to be incorporated into any contingency plans, as described in the *Non-Wires Opportunity Evaluation Methodology* report:

- Operating solution: 1 month
- Circuit or transformer load balancing: 18 months
- Circuit reconductoring or expansion (infrastructure upgrades not required): 24 months
- Circuit reconductoring or expansion (infrastructure upgrades required): 36 months
- New transformer (existing substation): 36–48 months
- New substation: 48 months

Except for operating solutions, deferral of capital expenditures opportunities may exist for the type of solutions listed above. However, as described in the *Non-Wires Opportunity Evaluation Methodology* report, the economic assessment and lead times will be taken into account when determining the path forward on non-wires solutions, if any.



# Appendix J. Non-Wires Opportunity Evaluation Methodology

---

## J.1. INTRODUCTION

As it strives to provide 100 percent renewable energy by 2045, Hawaiian Electric<sup>92</sup> (Company) faces an unprecedented situation: a comprehensive transformation of our five electric power grids. Attaining our state's renewable energy goals represents uncharted territory for both short-term and long-term resource planning. Performing the analyses necessary to attain this goal is a complicated resource planning process, requiring new tools and new processes. This report defines and explains the methodology involved in evaluating non-wires alternatives. This process is essential to support the transformation to a clean energy future that leverages the continuous advancement in power technology.

The Company believes customers should have opportunities to deliver energy and other services to the electrical distribution system (commonly referred to as the distribution grid). In addition, the Company believes it should enable significant numbers of diverse providers to participate, and should facilitate competition to the benefit of all customers. By using a broad definition of distributed energy resources (DER), which include a variety of asset types, the Company is providing an increasing number of customers with the opportunity to participate in the DER marketplace. Expanding opportunities for DER services is essential to meeting renewable energy needs without sacrificing the reliable delivery of electricity, which customers deem a top priority.

This strategy is consistent with the Commission's direction to fully and fairly consider non-transmission alternatives (NTA) and non-distribution alternatives (NDA), otherwise known as non-wires alternatives (NWA), when evaluating transmission and distribution (T&D) system upgrades.<sup>93</sup> The Commission also indicated that it will scrutinize whether NWA "solutions, regardless of ownership, are evaluated as part of any economic justification for new utility distribution system investment projects in the same fashion as it currently evaluates NTAs with respect to new transmission projects."<sup>94</sup>

---

<sup>92</sup> On December 20, 2019, the State of Hawai'i Department of Commerce and Consumer Affairs (DCCA) approved Hawaiian Electric Company, Inc., Maui Electric Company, Limited and Hawai'i Electric Light Company, Inc.'s application to do business under the trade name "Hawaiian Electric" for the period from December 20, 2019, to December 19, 2024. See Certificate of Registration No. 4235929, filed December 20, 2019, in the Business Registration Division of the DCCA.

<sup>93</sup> HPUC Docket No. 2018-0055, Decision and Order No. 36288 Ka'aahi Substation, filed May 3, 2019, at 22.

<sup>94</sup> HPUC Docket No. 2015-0070, Decision and Order No. 33584, filed March 11, 2016, at 46.

In 2019, the Commission reiterated its expectation that the distribution planning process “must transition and evolve accordingly, such that the locational benefits of customer-sited distributed energy resources are included and evaluated on a comparable basis as utility-sited NDAs as part of any economic justification for distribution system upgrades.”<sup>95</sup> The Commission further directed the Company to “strive to make their non-wires alternatives analysis more transparent and thorough.”<sup>96</sup>

Additionally, the Company is expanding options for broad DER participation necessary to grow a viable market, and for customers to directly benefit from competition. The Company’s strategy is to offer a range of proven and innovative options to expand access for all customers—not just for a few. This holistic approach to using DER to address grid needs is consistent with the Company’s proposed Advanced Rate Design Strategy.<sup>97</sup>

This approach recognizes that the market for NWAs is nascent but represents a tangible opportunity for reducing customer costs and enabling a lower-carbon electricity grid.<sup>98</sup> As such, procurements may not fully enable a range of DER-based solutions. The Company’s approach to NWAs specifically includes consideration of pricing through customer rates and programs in addition to procurement opportunities. This will enable customers to better manage their electricity use and provide grid services. As a result, the Company believes that customers, DER developers, and aggregators will have the potential to fully realize the value of DER for Hawai‘i.

The Company has engaged, and will continue to engage, with customers and stakeholders to seek input and feedback on the Integrated Grid Planning (IGP) development and subsequent planning and sourcing. As part of the IGP development effort, the Distribution Planning Working Group (DPWG) is to inform and educate stakeholders on various aspects of distribution planning at the Company, and to afford stakeholders opportunities to collaborate on and co-develop the Company’s methodologies to identify distribution grid needs as well as a framework to evaluate NWA opportunities. As described in the *Distribution Planning Methodology* (Appendix I), grid needs will be identified through the distribution planning process and then evaluated for NWA opportunity suitability as discussed in this *Non-Wires Opportunity Evaluation Methodology* (Appendix J).

The DPWG deliverables, as described in the IGP Workplan accepted by the Commission,<sup>99</sup> include identifying NWA opportunities and the related information requirements to effectively and efficiently procure and evaluate potential solutions. However, the need for an NWA

---

<sup>95</sup> HPUC Docket No. 2018-0055, Decision and Order No. 36288 Ka'aahi Substation, filed May 3, 2019, at 22.

<sup>96</sup> HPUC Order No. 36725 Docket No. 2018-0165, Proceeding To Investigate Integrated Grid Planning, filed November 4, 2019, at 9.

<sup>97</sup> Hawaiian Electric Companies, *Advanced Rate Design Strategy*, September 25, 2019. Filed in HPUC Docket No. 2018-0141.

<sup>98</sup> M. Dyson, J. Prince, et al., “The Non-Wires Solutions Implementation Playbook,” Rocky Mountain Institute, 2018.

<sup>99</sup> HPUC Order No. 36218, Accepting the IGP Workplan and Providing Guidance, Docket No. 2018-0165.

opportunity evaluation methodology was not identified in the original IGP Workplan.<sup>100</sup> The Company and stakeholders subsequently recognized the need to incorporate a screening process, based on the leading industry practices and practical considerations, into the IGP and annual distribution planning cycles. This *Non-Wires Opportunity Evaluation Methodology* report addresses this additional scope and deliverable discussed by the DPWG.

Specifically, this *Non-Wires Opportunity Evaluation Methodology* report discusses the Company's industry survey and stakeholder feedback on best practices for NWA opportunity evaluation and sourcing, defines NWAs and grid services, presents the Company's NWA opportunity evaluation methodology, and provides case examples that the Company and stakeholders used to jointly validate the proposed NWA opportunity evaluation methodology. Two of the case examples were used in the Company's IGP Soft Launch, which was conducted to demonstrate the distribution planning process from circuit-level load forecasting to solution evaluation to defer an actual capital investment to solve a grid need. The two examples used in the soft launch were the Ho`opili and East Kapolei cases, later described in Section 5.3. Through that effort, the Company to gained invaluable experience that will help improve the full-scale IGP planning and sourcing effort. This report reflects a key milestone in the Company's efforts to comply with the Commission's guidance regarding systematic and transparent consideration of NWAs, leveraging industry best practices, and stakeholder engagement.<sup>101</sup>

---

## J.2.INDUSTRY SURVEY

In 2019, the Company engaged the Pacific Energy Institute to conduct an industry survey<sup>102</sup> of best practices for NWA opportunity evaluation and sourcing in seven states (including California, Connecticut, Hawaii, Maine, New Hampshire, New York, and Rhode Island) as well as to review documents prepared by several organizations, including Rocky Mountain Institute (RMI),<sup>103</sup> Northeast Energy Efficiency Partnerships,<sup>104</sup> Smart Electric Power Alliance (SEPA),<sup>105</sup>

---

<sup>100</sup> HECO, IGP Workplan, December 2018 filed December 14, 2018 in HPUC Docket No. 2018-0165 [https://www.hawaiianelectric.com/documents/clean\\_energy\\_hawaii/integrated\\_grid\\_planning/dkt\\_20180165\\_20181214\\_igp\\_workplan.pdf](https://www.hawaiianelectric.com/documents/clean_energy_hawaii/integrated_grid_planning/dkt_20180165_20181214_igp_workplan.pdf).

<sup>101</sup> HPUC Order No. 33584, Maui Elec. Co., Ltd., Docket No. 2015-0070, filed March 11, 2016, at 45-46, and HPUC Order No. 36288, Ka'aahi Substation application, Docket No. 2018-0055, at 22-25.

<sup>102</sup> P. De Martini and A. De Martini, *NWA Opportunity Evaluation Survey of Current Practice*, Pacific Energy Institute, March 2020.

<sup>103</sup> M. Dyson, J. Prince, et al., "The Non-Wires Solutions Implementation Playbook," Rocky Mountain Institute, 2018..

<sup>104</sup> Northeast Energy Efficiency Partnerships, *State Leadership Driving Non-Wires Alternatives Projects and Policy*, 2017.

<sup>105</sup> SEPA, PLMA and E4The Future, *Non-Wires Alternatives: Case Studies From Leading U.S. Projects*, November 2018.

and ICF.<sup>106</sup> Additionally, an NWA workshop was held on March 26, 2019,<sup>107</sup> where the Company sought to learn from experienced practitioners (that is, utility and DER solution providers). The industry survey findings are summarized in Section J.2.1.

The Company also held 10 stakeholder working group meetings in 2019 where stakeholders discussed NWA services definitions, distribution grid needs identification, NWA opportunity evaluation, and information requirements. Stakeholder feedback is summarized in Section 2.2.

### J.2.1. INDUSTRY SURVEY FINDINGS

Based on the industry survey and observations of industry analysts, the use of NWAs for distribution grid needs is at an early stage. The industry is still learning and refining approaches to improve on the early mixed success to-date.<sup>108</sup> However, commonalities are emerging from these early states' and utilities' lessons learned that provide valuable insights for Hawai'i's success.

The Company has considered the following key findings from this survey in the development of its NWA opportunity evaluation process:

- The NWA opportunity evaluation should be integrated into standard, open, and transparent utility planning processes to encourage the effective engagement of market participants to best meet regulatory and utility-level objectives.<sup>109</sup>
- Traditional (T&D) planning processes can better support NWA solutions if screening criteria are used to determine when alternatives should be considered for a given need.
- Information should be shared with stakeholders regarding an NWA opportunity, including engineering analysis, performance requirements, and other data needed to assess the opportunity.
- Evaluation of opportunities is done on a technology agnostic, comparable basis as part of the economic justification for distribution system upgrades.<sup>110</sup>
- Evaluation processes focus on identifying high-confidence recommendations for DER solicitations that are likely to result in successful, cost-effective investment deferrals.<sup>111</sup>
  - NWA opportunities to date have initially addressed grid needs for capacity increases.

---

<sup>106</sup> ICF presentation in Michigan PSC workshop, June 2019  
[https://www.michigan.gov/documents/mpsc/062719\\_PDF\\_Presentations\\_660616\\_7.pdf](https://www.michigan.gov/documents/mpsc/062719_PDF_Presentations_660616_7.pdf).

<sup>107</sup> IGP Soft Launch WG Meeting speaker presentations:  
[https://www.hawaiianelectric.com/documents/clean\\_energy\\_hawaii/integrated\\_grid\\_planning/stakeholder\\_engagement/working\\_groups/soft\\_launch/20190326\\_igp\\_soft\\_launch\\_wg\\_meeting\\_presentation\\_materials.pdf](https://www.hawaiianelectric.com/documents/clean_energy_hawaii/integrated_grid_planning/stakeholder_engagement/working_groups/soft_launch/20190326_igp_soft_launch_wg_meeting_presentation_materials.pdf).

<sup>108</sup> Reported California initial NWA procurement results and ICF 2019.

<sup>109</sup> M. Dyson, J. Prince, et al., "The Non-Wires Solutions Implementation Playbook," Rocky Mountain Institute, 2018 and SEPA, PLMA and E4The Future, 2018.

<sup>110</sup> HPUC Order No. 36725 Docket No. 2018-0165, Proceeding To Investigate Integrated Grid Planning.

<sup>111</sup> CPUC Decision on the Distribution Investment and Deferral Process (D.18-02-004).

- Reliability, voltage/reactive power, and resilience have been identified for future consideration.
- The type of T&D need, time frame for in-service date, and reference T&D project cost are common criteria used by all states surveyed to evaluate NWA opportunities.
- Not all T&D capital projects are suited for an NWA opportunity. T&D capital projects involving break-fix, outage replacements, aging infrastructure replacement, infrastructure relocation, or customer service connections should be excluded.
- Procurements may not be best suited for all NWA opportunities (for example, smaller value projects and/or reaching certain customer classes), instead other programmatic options may be considered, such as:
  - Targeted energy efficiency (EE)/demand-side management programs are employed.
  - DER services tariffs are under discussion in a few states.
- States and utilities should first consider no-cost (capital) operational options (for example, circuit reconfiguration and phase balancing) as well as low-cost grid technology alternatives (for example, sensing and analytics, and power flow controllers) as an alternative to traditional capital projects<sup>112</sup>.

Additionally, the survey identified several themes regarding the evaluation criteria. As noted above, the type of T&D need, timing for in-service date, and reference T&D project cost are common criteria. The type of grid needs and the related performance requirements are considered. The timing for in-service includes consideration of the procurement/program development process, regulatory approval, and implementation timelines. Project cost is based on the capital cost of the traditional wires project.

However, the application of these criteria differs among states and utilities. The states in the Northeast have clearly defined the types of T&D projects that are suitable for NWA opportunities and have defined minimum thresholds for timing and project cost. These minimums have been developed through stakeholder discussions and consideration of the timing in that state. An example is provided in Figure J- 1.

---

<sup>112</sup> In addition, Hawaiian Electric is using advanced inverter functionalities.

Figure J- 1: National Grid’s New York NWA Opportunity Evaluation Criteria

Criteria	Potential Elements Addressed	
Project Type Suitability	Project types include Load Relief and Reliability. Other types have minimal suitability and will be reviewed as suitability changes due to State policy or technological changes.	
Timeline Suitability	Large Project	36-60 months
	Small Project	18-24 months
Cost Suitability	Large Project	Greater than or equal to \$1M
	Small Project	Greater than or equal to \$500K

Source: National Grid 2017

Like New York, as shown in Figure J- 1, California also employs these three criteria and adds two: forecast uncertainty of timing and scope, and market assessment. California’s evaluation is focused on whether an NWA procurement should be pursued and uses a tiered prioritization approach to identify the ripest opportunities (Tier 1), opportunities that may be less certain (Tier 2), and opportunities that are not suitable for NWAs (Tier 3). This is illustrated in the Southern California Edison (SCE) example in Figure J- 2. As seen in other states, California utilities each have their own version of the criteria and a slightly different prioritization tier structure.

Figure J- 2: SCE NWA Opportunity Prioritization

Tier	Project	Cost Effective	Forecast Certainty	Market Assessment
1	Nogales 66/12 (D)	Green	Green	Green
	Lockheed 66/16 (D)	Green	Orange	Green
	Sun City 115/12	Green	Yellow	Yellow
	Mira Loma 66/12 (D)	Green	Green	Yellow
2	Newhall 66/16 (D)	Yellow	Green	Green
	Crater 66/16 (D)	Yellow	Orange	Green
	MacArthur 66/12 (D)	Yellow	Yellow	Yellow
	Mariposa 66/12 (D)	Yellow	Green	Green
	Moorpark 'A' 220/66 (S)	Yellow	Green	Orange
	Saugus 'C' 220/66 (S)	Yellow	Orange	Orange
	Elizabeth Lake 66/16 (D)	Yellow	Orange	Yellow
	Elizabeth Lake 66/16 (D)	Yellow	Orange	Yellow
3	Vera 66/12 (D)	Orange	Yellow	Green
	Hathaway 66/12	Orange	Green	Green
	Rector 220/66 (S)	Orange	Yellow	Orange
	Springville 220/66 (S)	Orange	Orange	Yellow
	Garnet 115/33 (D)	Orange	Green	Orange
	Lindsay 66/12 (D)	Orange	Orange	Orange
	Live Oak 66/12 (D)	Orange	Yellow	Orange
Mira Loma 220/66 (S)	Orange	Green	Orange	

The California NWA evaluation methodology offers useful additional criteria to evaluate opportunities as compared to the states in the Northeast. However, the California methodology is overly complex in its attempt to quantify the metrics. In practice, California’s

prioritization is effectively based on a smaller set of factors similar to the northeastern states.<sup>113</sup> That is, the T&D grid need requirements (including timing), related grid service, and project-related avoided cost were used to determine whether a procurement makes sense. The California process is also singularly focused on evaluating procurement opportunities, so it does not consider alternative sourcing options, such as programs.

The Company does think the use of the California metrics for forecast certainty and market assessment are useful in the context of considering alternative NWA sourcing options involving programs and pricing, or reconsideration of procurement at a later date.

Based on the insights drawn from the industry survey and practitioners, simplicity and flexibility appear to be important considerations in developing NWA opportunity evaluation criteria. Simplicity is important in terms of the ability to implement a fair and repeatable process, and to provide clarity to the market. Flexibility is important in terms of allowing opportunities to pursue viable NWAs through sourcing means other than all-or-nothing procurements. For example, consideration should be given to the role that programmatic options may provide for opportunities that might otherwise not make sense economically for a procurement. The Company has incorporated these findings into its approach.

## J.2.2. STAKEHOLDER FEEDBACK

As mentioned at the beginning of Section 2, the Company held 10 stakeholder working group meetings in 2019 where stakeholders discussed NWA services definitions, distribution grid needs identification, NWA opportunity evaluation, and information requirements. These discussions included the findings from the industry survey and NWA workshop, discussed in Section 2.1. This stakeholder engagement also included using specific grid needs in Ho'opili and East Kapolei as case examples to shape the IGP Soft Launch.

Importantly, these discussions considered the development of the IGP methodology to identify and assess NWA opportunities as a key step in the handoff from grid needs to NWA sourcing (for example, procurements and programs). Stakeholders' input and feedback is reflected in the NWA opportunity evaluation process and criteria. The stakeholder feedback received in the DPWG and Soft Launch working group meetings is summarized in the following sections.<sup>114</sup>

### Overall Process

Stakeholders shared that the NWA opportunity evaluation process needs to be transparent and less restrictive with respect to screening criteria at this initial stage in Hawai'i to open up the potential market for procurements. Stakeholders also shared that a technology agnostic

---

<sup>113</sup> Cite to PG&E and SCE 2019 Distribution Deferral Opportunity Reports.

<sup>114</sup> Drawn from DPWG minutes: <https://www.hawaiianelectric.com/clean-energy-hawaii/integrated-grid-planning/stakeholder-engagement/working-groups/distribution-planning-and-grid-services-documents>



approach to assessing opportunities is needed and that it is important to not prejudge what the market may provide.

Stakeholders support consideration of other sourcing mechanisms beyond procurement (programs, tariffs) and flexibility in sourcing to achieve the most cost-effective outcome. This includes the potential to participate in multiple non-conflicting grid services opportunities. Additionally, the IGP process should continue to reassess projects in subsequent planning cycles that are initially assessed as uncertain because of the constant changing nature of the distribution system. The T&D grid needs and NWA opportunity evaluations and supporting analysis should be shared publicly as part of the IGP process.

### **Defining Grid Needs**

The output of the distribution planning process is a set of grid needs. Stakeholders should have sufficient information on these needs to consider potential solutions and understand the application of the evaluation criteria. This includes technical performance requirements, including quantity (MW, MWh), dispatch frequency and time (month/day/hour), duration, and in-service date. The supporting engineering analysis, and a description and technical details of the wires solution are also desired (for example, information on type of infrastructure location, timing, and avoided cost). Stakeholders suggested simplifying the requirements to the extent possible to allow for more potential NWA solutions.

### **Opportunity Criteria**

Stakeholders appreciate the simplicity of the three-criteria approach used by the states in the Northeast but also like aspects of the California prioritization model. Stakeholders suggested using clearly defined metrics for minimum timing for in-service date and project economics criteria for procurements, as follows:

- Timing: in-service date – minimum of 2 years to provide enough time to run a procurement and regulatory process, and install NWAs
- Project economics: minimum of \$1 million capital project cost threshold for NWA procurements

Stakeholders also suggested consideration of greenhouse gas emissions reductions and other societal criteria (for example, community impact) in prioritizing NWA opportunities. The question of whether to consider greenhouse gas emissions was not resolved in the working group discussion, but stakeholders recognized that greenhouse gas benefits are important, but not necessary, for NWA opportunity sourcing evaluation. Stakeholders suggested that NWA societal value considerations may be better suited to evaluating the specific proposed NWA solutions resulting from procurements/programs as is done in New York. The recommendation is for this issue to be taken up in the Solution Evaluation and Optimization Working Group.

### **Sourcing Options**

Stakeholders noted that across the industry, NWAs have largely not been successful thus far. Stakeholders recognize that procurements are one type of NWA sourcing mechanism and that programs and pricing options should be considered as well. A programmatic approach that



looks to fulfill more global power system needs was suggested. Programs also may be easier for customers to understand. Stakeholders agree that an NWA program, as with procurements, must be cost-effective for all customers.

During the Soft Launch discussion regarding Ho'opili, stakeholders recognized the NWA procurement challenge for new real estate developments: that NWA solutions may need to be sited and ready to go at the same time the house is built. Stakeholders suggested that a programmatic approach (including EE and other DER) through the collaboration of the real estate developer and the Company may be the best option.

Additionally, stakeholders seek to maximize the potential participation opportunities for NWAs and grid services in the aggregate. For example, a stakeholder shared that a \$50,000 per year NWA opportunity may not be worth a procurement or program, but it may have potential after being aggregated with other potential grid services opportunities.

---

### J.3.T&D NON-WIRES ALTERNATIVES

The definitions of NWA and grid services presented in this section, including the specific wording for each of the terms, are derived from the industry research and stakeholder input and feedback discussed in Section 2.

#### J.3.1. NWA DEFINITION

NWAs generally are non-traditional solutions that may defer, delay, or avoid traditional T&D investments (for example, a new substation or feeder). Non-traditional solutions can include a single solution or a combination of solutions at the grid-scale or distribution level, such as solar photovoltaic (PV), other renewable generation, energy storage, EE, and demand response (including price responsive demand). The following NWA definition was developed in concert with the DPWG:

*An electricity grid project that uses non-traditional transmission and distribution (T&D) solutions, such as distributed generation (DG), energy storage, energy efficiency (EE), demand response (DR), and grid software and controls, to defer or avoid the need for conventional transmission and/or distribution infrastructure investments.*

This definition adapts several aspects developed by Navigant,<sup>115</sup> the US Department of Energy,<sup>116</sup> and others.<sup>117</sup>

### J.3.2. NWA GRID SERVICES

A wide range of grid services are needed as Hawai'i decarbonizes the electricity sector with ultimately more than half its resources at the edge of the system. Already, DERs have the opportunity to provide bulk system ancillary services, including frequency response, replacement reserves, and regulation on a technology agnostic basis.<sup>118</sup> Additionally, in support of the IGP planning cycle and Commission direction,<sup>119</sup> the Company has identified and defined initial T&D NWA services in technology agnostic terms, building on the work developed for the Demand Response portfolio in Docket No. 2015-0412. An example of where the Company will apply the NWA evaluation process are the projects identified through the distribution planning process, as described in the *Distribution Planning Methodology* report. Using the outline detailed in this report, these projects are candidates to be evaluated for NWA opportunity.

Specifically, these initial NWA services are focused on those with the greatest potential value involving T&D capital deferral services (for example, distribution capacity deferral and reliability services). Capital deferral is the primary focus of the Federal Energy Regulatory Commission for transmission<sup>120</sup> and the leading states' use for distribution, as found in the industry survey discussed in Section 2.

The service descriptions and definitions in Sections 3.2.1 and 3.2.2 are based on IGP stakeholder input and feedback leveraging references from California's Competitive Solicitation Working Group.<sup>121</sup>

#### J.3.2.1. T&D Capacity Deferral

T&D capacity deferral opportunities involve the potential to defer capital investment that may otherwise be needed to address grid needs that are identified through area capacity analysis and/or hosting capacity analysis. This may include deferring substations, new lines/reconductoring, transformers, and other equipment by reducing forecast loading of the

---

<sup>115</sup> B. Feldman, Non-Wires Alternatives: What's up next in utility business model evolution, UtilityDive, July 12, 2017.

<sup>116</sup> Electricity Advisory Committee, Recommendations on Non-Wires Solutions, US Department of Energy, October 17, 2012.

<sup>117</sup> SEPA, PLMA & E4TheFuture, "Non-wires Alternatives: Case Studies from Leading US Projects", 2018.

<sup>118</sup> See Docket No. 2015-0412, Decision and Order No. 35238, issued on January 25, 2018.

<sup>119</sup> HPUC Order No. 33584, Maui Elec. Co., Ltd., Docket No. 2015-0070, filed March 11, 2016, at 45-46.

<sup>120</sup> E. Watson and K. Colburn, Looking Beyond Transmission, Public Utilities Fortnightly, April 2013.

<sup>121</sup> California Competitive Solicitations Framework Working Group <https://drpwg.org/sample-page/ider/>.

infrastructure to within ampacity/load ratings under normal operating conditions. Loading in this context relates to the current and/or power (bi-directional) carrying capability of specific conductor, transformer, and/or other equipment. Therefore, increases in forecast loading may arise from new loads and/or energy injections from distributed resources (that is, reverse power flow).

The following definition of T&D capacity service was developed with the DPWG to describe these types of opportunities:

*A supply and/or a load modifying service that DERs provide as required via reduction or increase of power or load that is capable of reliably and consistently reducing net loading<sup>122</sup> on desired transmission and/or distribution infrastructure. T&D capacity service can be provided by a single DER and/or an aggregated set of DERs that reduce the net loading on a specific distribution infrastructure location coincident with the identified operational need in response to a control signal from the utility.*

This definition combines both NTAs and NDAs into a single service in recognition of the potential to yield optimized benefits across T&D opportunities from NWA solutions.

### J.3.2.2. Distribution Reliability (Back-Tie)

In addition to NWA opportunities under normal grid operating conditions, there are potential opportunities under contingent conditions. Contingent operating conditions involve emergency reconfigurations of the distribution system that result in transferring the load (that is, bi-directional current/power) from one circuit/transformer to another to mitigate an outage. These contingent opportunities arise when combined loading exceeds the emergency ampacity/power rating of the conductor, transformer, and/or other equipment. This is a reliability-oriented service because it enables safe transfer of one circuit/transformer's load to another during an emergency by creating sufficient headroom or reducing the transferring load to within emergency ratings.

The following definition of distribution reliability service was developed in the DPWG:

*A supply and/or load modifying service capable of improving local distribution reliability under abnormal conditions. Specifically, this service reduces contingent loading of grid infrastructure to enable operational flexibility to safely and reliably reconfigure the distribution system to restore customers.*

This type of distribution service is relatively new in the industry; the Company's procurement for this service in the IGP Soft Launch was one of the first, if not the first. In a future IGP cycle, the Company may evaluate a wider set of T&D NWA services. For example, voltage support

---

<sup>122</sup> Net loading refers to the net amount of bi-direction current on specific grid infrastructure.

and resiliency services may be identified and defined through the process of documenting the T&D needs and services requirements. Resiliency services are currently being discussed in the Resiliency Working Group and through Docket No. 2018-0163, which is intended to produce a Microgrid Services Tariff.

---

## J.4.NWA OPPORTUNITY EVALUATION METHODOLOGY

### J.4.1. OVERVIEW

The Company has considered the NWA opportunity evaluation approaches and lessons learned from other states as well as stakeholder feedback to develop a holistic methodology. The multi-state lessons and stakeholder feedback support RMI's recommendation that *"traditional planning processes can better support non-wires solutions if screening criteria are used to determine when alternatives should be considered for a given need."*<sup>123</sup>

The Company intends to use such a common NWA opportunity evaluation framework to identify T&D projects that are most likely to be suitable for NWA solutions. This evaluation methodology is intended to provide greater clarity, certainty, and transparency to the market going forward. Such criteria incorporated into the IGP process will also facilitate systematic consideration of NWAs by T&D planners going forward as directed by the Commission. The goals of this NWA opportunity evaluation methodology are as follows:

- Identify all potential candidate T&D projects that may be cost-effectively deferred through the identified and defined DER services.
- Productively engage the market for NWAs by helping DER aggregators and developers efficiently allocate resources to the best opportunities.

Further, Commission guidance and stakeholder feedback outlined the following objectives in the development of an NWA opportunity evaluation framework:

- Adopt/adapt leading practices to develop candidate T&D NWA opportunity evaluation.
- During initial NWA opportunity screens, create over-inclusive, rather than overly restrictive, candidate NWA project shortlists.
- Use a simple initial NWA opportunity screen to identify shortlist candidate opportunities and assess sourcing options (procurement, programs, and pricing).
- Remember that not all NWA opportunities make economic sense to source via competitive procurement. Therefore, price signals through rate design and DER

---

<sup>123</sup> M. Dyson, J. Prince, et al., "The Non-Wires Solutions Implementation Playbook", Rocky Mountain Institute, 2018.

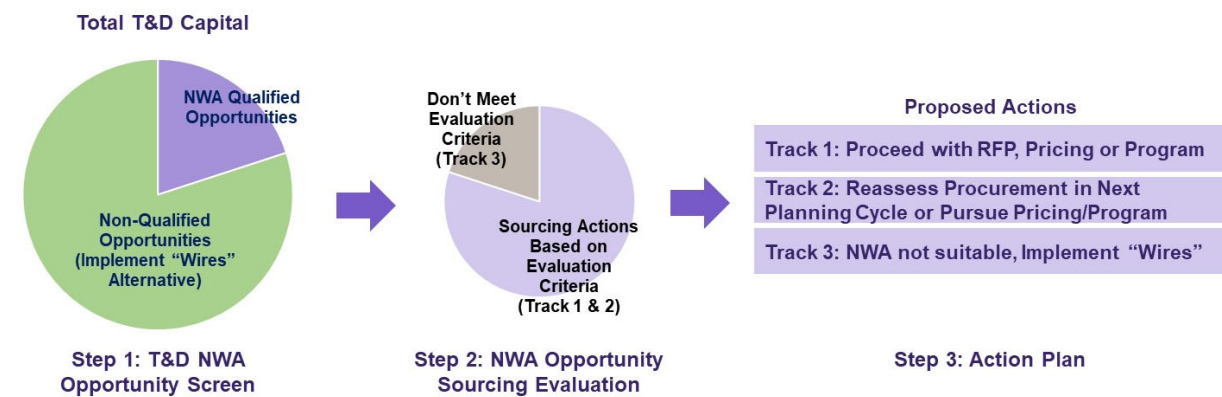
programs will also be considered to achieve the most affordable solutions for customers.

These goals and objectives shaped the development of the NWA opportunity evaluation methodology described in Section 4.2. The Company believes that this opportunity screen and prioritization approach will support development of an NWA market. Recognizing that NWA procurements and use are at a relatively nascent stage of implementation across the industry, the Company expects this evaluation methodology to evolve as the industry collectively gains more NWA experience. This NWA opportunity evaluation methodology is not meant to be an NWA solution evaluation as would be done in a procurement; rather this is an assessment of the potential T&D projects that qualify for an NWA opportunity.

### J.4.2. OPPORTUNITY EVALUATION METHODOLOGY

The Company has developed a three-step methodology that incorporates 1) an initial NWA opportunity screen, 2) an NWA opportunity sourcing evaluation and 3) an action plan. The initial opportunity screen is intended to quickly and simply identify “qualified” and “non-qualified” T&D opportunities based on technical requirements and timing of need. The opportunity sourcing evaluation in the second step further evaluates and prioritizes the “qualified” opportunities in terms of the grid project avoided cost (economics), uncertainty regarding timing and/or scope of need, and market potential to support a procurement. This three-step approach, shown in Figure J- 3, is based on leading practices from states in the Northeast and from California as well as stakeholder feedback tailored to Hawai’i’s needs.

Figure J- 3: NWA Opportunity Evaluation Methodology



This methodology is designed to identify a wider set of potential NWA opportunities than methodologies in other states. Step 1 does not include a dollar threshold, unlike the states in the Northeast; instead, program or pricing options may be considered viable in the Step 2 evaluation. The incorporation of program and pricing options in the Step 2 sourcing evaluation is for those opportunities considered too financially small for procurement. Step 2 methodology also includes a clearly defined minimum dollar threshold for procurements

identified by stakeholders that is similar in approach to that of the states in the Northeast. This is a more transparent method than the overly complex California approach<sup>124,125</sup> that also effectively uses the project capital avoided cost as the primary economic threshold. The resulting T&D action plan in Step 3 is intended to enable a range of potential NWA sourcing options via procurement, programs, and pricing consistent with another RMI recommendation.<sup>126</sup>

#### J.4.2.1. Step 1: NWA Opportunity Screen

The intent of the NWA opportunity screen is to categorize all T&D capital budget projects by applying a technical and timing screen and to identify those T&D projects that are most suitable for further NWA opportunity evaluation. As discussed with stakeholders and identified by other states, certain T&D projects with the greatest NWA opportunity include the following three grid needs categories:

1. Expanding distribution system capacity to meet load and/or hosting capacity needs (that is, new substation, new feeders, reconductoring)
2. Ensuring a reliability requirement for circuit back-tie upgrade deferral
3. Enhancing system resilience<sup>127</sup>

As the Company has identified in the IGP, consistent with best industry practices, these types of T&D needs may be met by new NWA grid services, including T&D capacity deferral service, reliability back-tie service, and resiliency service. The Soft Launch pursued procurement of distribution capacity deferral and reliability back-tie services. The Company's reliability back-tie service is a first for the industry. These three types of T&D needs will form the initial screen.

Conversely, certain T&D projects cannot, or are unlikely to, be deferred or avoided by DER. These "required" projects include those necessary to comply with public works or other customer requests, such as the following:

- Line/pole relocation or undergrounding due to street widening, relocation clauses, or overhead-to-underground conversions
- Emergency and preventative equipment and infrastructure replacement to restore power after outages, avoid outages and catastrophic failures through hardening or strengthening of critical infrastructure, and ensure public safety

---

<sup>124</sup> Pacific Gas & Electric, Request for Approval to Issue Competitive Solicitations for Distributed Energy Resource (DER) Procurement for Electric Distribution Deferral Opportunities. November 15, 2019. CPUC Advice Letter 5688-E.

<sup>125</sup> Southern California Edison, Southern California Edison Company's Request for Approval to Launch the 2020 Distribution Investment Deferral Framework, November 15, 2019 Solicitation. CPUC Advice Letter 4108-E.

<sup>126</sup> M. Dyson, J. Prince, et al., "The Non-Wires Solutions Implementation Playbook", Rocky Mountain Institute, 2018, page 39.

<sup>127</sup> Reliability scoped to be redundant, such as adding a second feeder and its associated infrastructure, would be qualified opportunities.

- Replacement of physical apparatus, such as circuit breakers, relays, and transformers, because of asset condition
- Replacement of damaged or failed equipment/poles/conductor
- New customer requests for new physical connection to the electric grid

Timing of the grid need is also an important factor. Sufficient lead time is required to allow for a procurement (including contract negotiations) or program development, regulatory approval, and NWA solution deployment by the in-service date, as required by the forecasted operational date, to meet the grid need. Based on the Company's experience with sourcing other grid services, and consistent with stakeholder feedback and industry practice, a starting point of a 2-year lead time will be used.

One lesson learned from the industry survey was that the time needed for NWA procurement contract negotiations and subsequent regulatory approval are key factors in the time required. In addition, depending on the complexity of the contingent wires solution in the event the NWA sourcing does not yield a viable solution, more lead time may be needed. The minimum timing threshold may be adjusted as the Company, the market, and the Commission learn from the Soft Launch and future opportunities.

The Step 1 screen will categorize all T&D opportunities in the Company's capital budget into two groups:

- T&D projects with an NWA opportunity involving one or more of the three grid needs categories described earlier in this section
- T&D projects that address "required" needs outside of the three NWA opportunity categories

This step can be done in conjunction with the Company's annual capital budgeting process to ensure that consistency is applied across the enterprise. Those T&D projects identified as required in this initial screen will be pursued as utility wires solutions in the appropriate regulatory approval procedure.

Focusing on the most viable NWAs by categorizing opportunities by these specific capital project types is employed in every state currently pursuing NWAs.

#### J.4.2.2. Step 2: NWA Opportunity Sourcing Evaluation

The Company, through the use of NWAs, seeks to expand options for broad participation in support of growing a viable DER market to meet Hawai'i's goals. It is also important for all customers to directly benefit from the use of DER. As such, the Company's approach is to consider a range of competitive market-based procurement, program, and pricing options to expand access for all customers—not just for a few. This approach is different than what



California and other states consider in their NWA procurement-focused opportunity evaluations.

While the Company's methodology adapts aspects of California's<sup>128</sup> evaluation criteria, it is done here in the context of assessing other sourcing options, such as programs and retail pricing, as well as procurements on the basis of favorable, uncertain, or unfavorable attributes. The implied precision of California's complex quantitative approach, in practice, does not identify more NWA procurement opportunities than the simpler methods employed in other states. Based on the six mainland states surveyed, NWA opportunities for procurement averaged approximately 1 to 2 percent of all T&D capital projects<sup>129</sup> and about 5 to 10 percent of initially screened distribution upgrade projects.<sup>130</sup>

The Company is adapting elements of the California approach as such elements are useful in considering sourcing options other than procurements. Therefore, the intent of this second step is to evaluate candidate T&D NWA opportunities in greater detail to identify those with the highest likelihood of success and related solution sourcing options. This NWA opportunity sourcing evaluation is technology agnostic, consistent with the Company's IGP process.

The following four equally weighted criteria will be used to evaluate NWA opportunities:

- **Performance requirements** in relation to engineering and operational performance requirements of the identified T&D grid need
- **Forecast certainty** of the forecast scope and timing of the grid need
- **Project economics** in terms of the deferral value of a qualified T&D capital project and any other relevant avoided costs to determine sourcing options
- **Market assessment** based on the potential for successful NWA procurement versus programs or retail pricing options in the immediate local area related to the grid need

Each grid project will be assessed in relative terms within each criterion. The criteria are further explained below.

#### Performance Requirements

The performance requirements criterion will be used to determine whether NWA solutions can reasonably meet the performance requirements of the identified grid need (capacity expansion, reliability back-tie, or resiliency). Projects that target critical needs with high operational risks are more likely to require more stringent performance requirements and contract terms for NWA solutions. In general, opportunities with more lenient requirements are more viable for NWAs. For example, if the opportunity has a smaller peak capacity, shorter

---

<sup>128</sup> California PUC Decision on the Distribution Investment and Deferral Process (D.18-02-004).

<sup>129</sup> California utilities' distribution deferral opportunities reports for 2018 and 2019 are consistent with this finding.

<sup>130</sup> P. De Martini and A. De Martini, NWA Opportunity Evaluation Survey of Current Practice, Pacific Energy Institute, March 2020

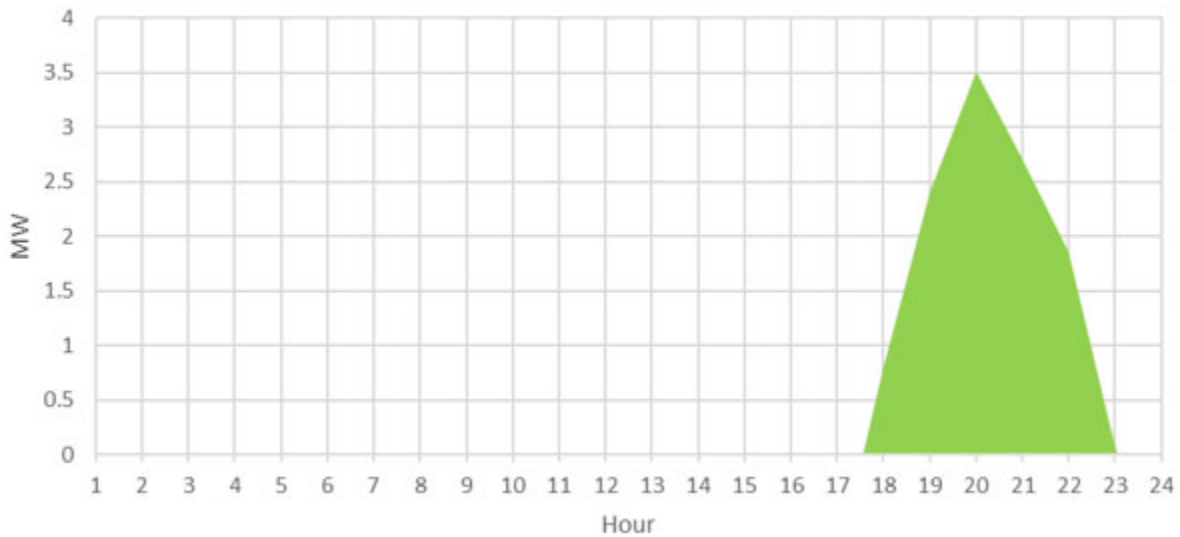


duration needs, and fewer calls, then the ability to meet the performance requirements will be considered more favorable for an NWA.

The grid need will be clearly described as illustrated in Figure J- 4, along with supporting engineering and operational analyses as provided in the Soft Launch<sup>131</sup> and case examples<sup>132</sup> discussed with the DPWG in August and October 2019.

Figure J- 4: Example Engineering Analysis and Performance Requirements

Projected Hourly Needs Summary



Equipment	MW Peak	MWH	Delivery Months	Delivery Hours	Duration (Hr)	Max # of Days
Tsf/Circuit	3.5	11.4	Jan - Dec	5PM - 11PM	6	365

These performance requirements are intended to provide as complete a picture as possible of the grid need and operational performance required of solutions to transparently inform stakeholders.

Forecast Certainty

The forecast certainty criterion will be used to evaluate the grid need in relation to the forecast certainty of the need in terms of scope and timing. While a quantitative metric for forecast

<sup>131</sup> DPWG Meeting August 8, 2019 "Review of Soft Launch Opportunity" presentation: [https://www.hawaiianelectric.com/documents/clean\\_energy\\_hawaii/integrated\\_grid\\_planning/stakeholder\\_engagement/working\\_groups/distribution\\_planning/20190808\\_dpwg\\_meeting\\_presentation\\_materials.pdf](https://www.hawaiianelectric.com/documents/clean_energy_hawaii/integrated_grid_planning/stakeholder_engagement/working_groups/distribution_planning/20190808_dpwg_meeting_presentation_materials.pdf).

<sup>132</sup> DPWG Meeting October 9, 2019 "Review of T&D NWA Opportunity Identification & Evaluation Process" presentation: [https://www.hawaiianelectric.com/documents/clean\\_energy\\_hawaii/integrated\\_grid\\_planning/stakeholder\\_engagement/working\\_groups/distribution\\_planning/20191009\\_dpwg\\_meeting\\_presentation\\_materials.pdf](https://www.hawaiianelectric.com/documents/clean_energy_hawaii/integrated_grid_planning/stakeholder_engagement/working_groups/distribution_planning/20191009_dpwg_meeting_presentation_materials.pdf).

certainty is not feasible, the Company will consider qualitative factors such as, but not limited to, the following:

- Is the forecast driven by actual electric service requests? This would signal moderate to high certainty depending on the stage of the development process that the developer is in (for example, advanced stage of design or marketing/sales of the development is ongoing).
- Is the forecast driven by conceptual or high-level master plans? This would signal low to moderate certainty of the actual load materializing.
- Are there steady historical trends of load growth (for example, caused by increased customer adoption of electric vehicles or air conditioning)? This would signal moderate certainty.

A future consideration for an uncertain forecast with a grid need identified beyond 5 years is to initiate a targeted program leading up to the longer-term need to potentially avoid that future distribution investment. This approach has the benefit of a longer “runway” for a program to ramp up leading up to the longer-term identified need.

#### Project Economics

The project economics criterion will be used to evaluate opportunities for procurement, programs, and/or pricing, and to identify opportunities that are unlikely to be cost-effective. The project economics include the deferral value of a qualified T&D capital project and any other relevant avoided costs. Based on stakeholder feedback, projects with an economic value (that is, capital cost) of \$1 million or greater will be pursued for NWA procurement. Projects with an economic value less than \$1 million may be considered for targeted DER programs to address specific NWA needs consistent with the Company’s Advanced Rate Design Strategy.<sup>133</sup>

#### Market Assessment

The market assessment criterion will be used to initially assess the following two aspects in terms of procurement/program sourcing options:

- Technical potential based on the number of customers available for behind-the-meter solutions and land availability for ahead-of-the-meter solutions
- Supplier and solution diversity to ensure competitiveness and reliability

The opportunity for a DER-based alternative is dependent on sufficient existing or new customers and/or land availability in the appropriate locations associated with the circuits and/or substation(s) to develop an NWA solution sufficient to meet an identified grid need. Also, as procurements are intended to foster competitive solutions, it is beneficial to identify

---

<sup>133</sup> Hawaiian Electric Companies, Advanced Rate Design Strategy, September 25, 2019. [https://www.hawaiianelectric.com/documents/clean\\_energy\\_hawaii/grid\\_modernization/dkt\\_2018\\_0141\\_20190925\\_cos\\_A\\_RDS.pdf](https://www.hawaiianelectric.com/documents/clean_energy_hawaii/grid_modernization/dkt_2018_0141_20190925_cos_A_RDS.pdf)

whether sufficient customers and/or land opportunity exists to support competitive proposals from more than one provider. These factors will be used to evaluate the potential success of an NWA procurement/program and any mitigation measures that may be needed to realize a successful outcome for customers. For instance, as proposed by stakeholders, an NWA program may provide a better outcome for a new residential development than a procurement.<sup>134</sup>

### J.4.2.3. Step 3: Action Plan

The NWA opportunity sourcing evaluation discussed in Section 4.2.2 results in a T&D action plan that assigns specific T&D projects to one of three action plan tracks. The assigned action plan track will provide the path the Company will use to pursue a solution. Competitive procurement is the primary means of sourcing opportunities \$1 million or greater. However, based on stakeholder discussion in the DPWG, the Company sought to expand the potential for NWAs by including the option for programs and pricing for opportunities under \$1 million and for those opportunities that do not lend themselves to procurement, such as new real estate developments. As such, this sourcing approach adapts the California model by explicitly incorporating the option for programs and pricing options in Track 2 to expand the potential for NWA solutions for grid needs less than \$1 million in economic value.<sup>135</sup> The three tracks are as follows:

- **Track 1:** Procurement of large, certain opportunities (that is, greater than \$1 million in economic value with in-service need in 2 to 5 years) with high likelihood of NWA success for procurement (that is, performance and market).
- **Track 2:** Procurement if factors indicate reevaluating in the future for potential procurement (that is, greater than \$1 million in value and timing and uncertainty of grid need); a program if the opportunity is certain with greater than \$1 million in value, is considered cost-effective for customers, and performance can likely be met (for example, new real estate developments); and pricing if the economic value is less than \$1 million and potential timing of need is sufficiently long to account for customer adoption, which may be longer than a targeted program.
- **Track 3:** Non-qualified opportunities that have criteria (for example, performance, timing, or economics) that cannot be reasonably met by NWA solutions. In these instances, the wires solution will be implemented.

---

<sup>134</sup> Stakeholder comments on programmatic approach for NWA in DPWG meetings beginning in July 17, 2019 meeting: [https://www.hawaiianelectric.com/documents/clean\\_energy\\_hawaii/integrated\\_grid\\_planning/stakeholder\\_engagement/working\\_groups/distribution\\_planning/20190717\\_dpwg\\_meeting\\_summary\\_notes.pdf](https://www.hawaiianelectric.com/documents/clean_energy_hawaii/integrated_grid_planning/stakeholder_engagement/working_groups/distribution_planning/20190717_dpwg_meeting_summary_notes.pdf)

<sup>135</sup> Note that in the Northeast and California, the utilities employ demand side management programs funded by existing customer public surcharges to mitigate grid needs before pursuing NWA procurements.

The action plan will include a summary list of T&D project opportunities evaluated and the proposed course of action on solutions for each grid need, as illustrated in Figure J- 5. In addition, the supporting evaluation for each NWA opportunity will be discussed.

Figure J- 5: T&D NWA Opportunity Evaluation

Track	Grid Need	Performance Requirements	Timing	Forecast Certainty	Market Assessment	Economic Assessment
1	Project A	5hr Peak Load Reduction	Jan 2023- Dec 2027	Favorable	Favorable	\$4 million Avoided Cost
2	Project B	4hr Peak Load Reduction	Jan 2024- Dec 2028	Uncertain	Uncertain	\$750,000 Avoided Cost
3	Project C	16x7 Load Reduction	Jan 2023- Dec 2027	Favorable	Unfavorable	\$250,000 Avoided Cost

Figure J- 5 identifies potential distribution opportunities in one of the three tracks described above, along with a corresponding color code—green (favorable), yellow (uncertain), and red (unfavorable)—to highlight the assessment of each criterion to indicate why the opportunity was placed into the given track.

#### J.4.2.4. Contingency Plan

The primary goal of action plans Track 1 and Track 2, as mentioned in section 4.2.3, is to pursue successful deferral of the grid project with DER. However, for the Company to meet its obligation to provide electric service, there may be a need to develop a contingency plan based on grid investment or another alternative to ensure that the in-service date and lead time to implement those solutions may be met.

During DER procurement and/or program implementation, solicitation/program development, DER deployment/customer adoption, or DER commercial operation, several scenarios may occur that could cause the DER solution to not viably solve the grid need. For example, if there are no cost-effective DER bids that meet the distribution need, or if contracts are not approved by the Commission, implementation of the Company’s contingency solution will be needed. This contingency solution may include the wires project originally intended for deferral. For this reason, it will be necessary to continue preliminary engineering solution development activity, such as wires project engineering and other related activity.

As the NWA process and market mature, a framework may need to be developed that covers contingency planning for NWAs similar to what has been developed for competitive bidding of generation.<sup>136</sup> As part of the Competitive Procurement Working Group within the IGP process, the Company is revising the competitive bidding framework to cover procurement of NWAs.

<sup>136</sup> See, Decision and Order No. 23131 filed on December 9, 2006 in Docket No. 03-0372, Instituting a Proceeding to Investigate Competitive Bidding for New Generating Capacity in Hawaii. Available at, <http://files.hawaii.gov/dcca/dca/dno/dno2006/23121.pdf>

Modifications to contingency planning will be covered by those revisions as well as processes and procedures to facilitate the procurement of NWAs.

If DER bids meet most of the distribution need, but not all of the need required for a full deferral, the Company may develop short lead time mitigation alternatives that supplement the DER portfolio for the total solution where feasible. Depending on how early in the procurement process the shortcoming is known and the amount that will be insufficient, the Company may initially attempt to use DERs as a contingency measure to supplement the deficiency or may consider smaller wires solutions and/or operational constraints to temporarily remedy a deficiency. If a cost-effective solution does not exist, the Company may need to pursue the contingency plan's alternative solution. This may include operating solutions, up to pursuing the initial traditional solution. For example, if an NWA solution can resolve a distribution line overload, but the location leaves a portion unmitigated, that smaller remaining portion may still be reconductored to supplement the NWA solution. Such contingency solutions may require the Company to seek expedited approval by the Commission.

If the DER provider is unable to install DERs according to the contract, the Company may develop short lead time mitigation alternatives that supplement the DER portfolio for the total solution where feasible in accordance to the wire solutions development<sup>137</sup> steps. The supplemental solution would be the least complex solution that addresses the shortcoming. This could include an operating solution, like switching, that uses existing equipment or load balancing. If a cost-effective DER mitigation solution does not exist, the Company may pursue the contingency solution.

If the DER fails during field commissioning or underperforms during operations based on commissioning and performance verification protocols agreed to in the contract, the Company will determine emergency limitations, if applicable, and will work with system operations on potential grid reconfiguration or load drop for all scenarios above. The Company will determine the reason for DER underperformance, assess any equipment damage or outage impacts, assess whether new mitigation is required, and determine expedited solution options. If issues such as these arise and result in adverse impacts on reliability (that is, system average interruption duration index and system average interruption frequency index metrics), then any associated impacts on performance incentives/penalties must also be considered.

The absolute latest a decision can be made for a distribution project intended for deferral is directly after final design is complete and before the scheduling, permitting, and construction of the project begins. This varies depending on the project being deferred, but typically distribution projects that do not require permitting require a project commencement decision to be made at least 12 to 48 months prior to the need date (as described in the *Distribution Planning Methodology* report, Section 6.2). The timing of the contingency decision process

---

<sup>137</sup> See the *Distribution Planning Methodology* report, Section 6.

may change over time as the Company continues to understand the impact of scheduling traditional and DER solutions in parallel.

Cost recovery of preliminary engineering costs for contingency solutions is another issue that may need to be raised with the Commission in the future. The Company acknowledges that the issue of preliminary engineering costs that are expended to produce contingency or parallel plans to third-party contracted NWA services may be discussed in the performance-based regulation proceeding as part of the discussion on adjustments to the major project interim recovery mechanism.

---

## J.5. CASE EXAMPLES

The Company shared several identified grid needs with stakeholders at the October 9, 2019, DPWG meeting for the purpose of jointly validating the proposed NWA opportunity evaluation methodology with real examples.<sup>138</sup> These real T&D projects have been identified and scoped by the Company for consideration. These illustrative projects were discussed with stakeholders to refine the NWA opportunity evaluation methodology and to jointly assess each opportunity. For this reason, a representative set of examples that includes projects that are typically screened out of NWA consideration in California and the Northeast were included for the DPWG discussion. As such, this list is not the complete list of potential grid projects, nor does it represent a final list of evaluated NWA opportunities as is found in the California Distribution Deferral Opportunity Report, for example. However, the results of the DPWG's feedback and application of this methodology in the Soft Launch and in the DPWG meetings is consistent with the California and Northeast approaches to identifying viable NWA opportunities for procurement.<sup>139</sup> The following is only a summary of the DPWG discussion regarding the case example projects screened in Step 1 and Step 2 of the process.<sup>140</sup>

### J.5.1. STEP 1: NWA OPPORTUNITY SCREEN

Several case example T&D projects were discussed with stakeholders. The projects presented in this section are examples of capital projects that do not represent viable NWA opportunities

---

<sup>138</sup> October 9, 2019, DPWG meeting presentation, see slides 19-54  
[https://www.hawaiianelectric.com/documents/clean\\_energy\\_hawaii/integrated\\_grid\\_planning/stakeholder\\_engagement/working\\_groups/distribution\\_planning/20191009\\_dpwg\\_meeting\\_presentation\\_materials.pdf](https://www.hawaiianelectric.com/documents/clean_energy_hawaii/integrated_grid_planning/stakeholder_engagement/working_groups/distribution_planning/20191009_dpwg_meeting_presentation_materials.pdf).

<sup>139</sup> Note: In 2019, PG&E and SCE identified a combined total of over 800 grid needs that were screened to only 10 projects (6 for SCE and 4 for PG&E) for NWA procurement. This is consistent with the experience in the Northeast.

<sup>140</sup> October 9, 2019, DPWG Meeting Summary Notes  
[https://www.hawaiianelectric.com/documents/clean\\_energy\\_hawaii/integrated\\_grid\\_planning/stakeholder\\_engagement/working\\_groups/distribution\\_planning/20191009\\_dpwg\\_meeting\\_summary\\_notes.pdf](https://www.hawaiianelectric.com/documents/clean_energy_hawaii/integrated_grid_planning/stakeholder_engagement/working_groups/distribution_planning/20191009_dpwg_meeting_summary_notes.pdf).

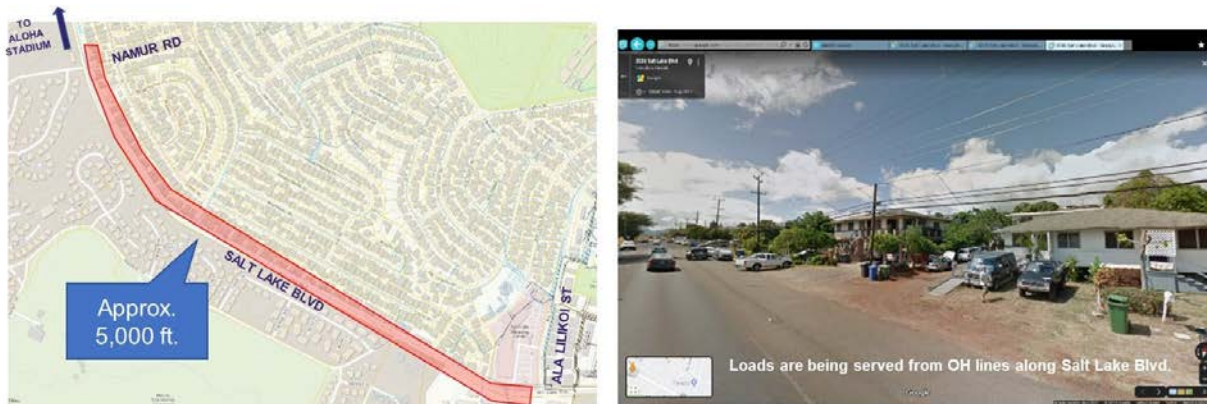


and, as such, would be screened out in Step 1 of the process. The projects that passed Step 1 screening are discussed under Step 2 in Section 5.2.

### Salt Lake Boulevard Overhead Line Relocation

This project involves an overhead (OH) to underground (UG) line conversion and relocation of Salt Lake Boulevard OH lines requested by public works, as illustrated in Figure J- 6.

Figure J- 6: Salt Lake Boulevard Overhead Line Relocation

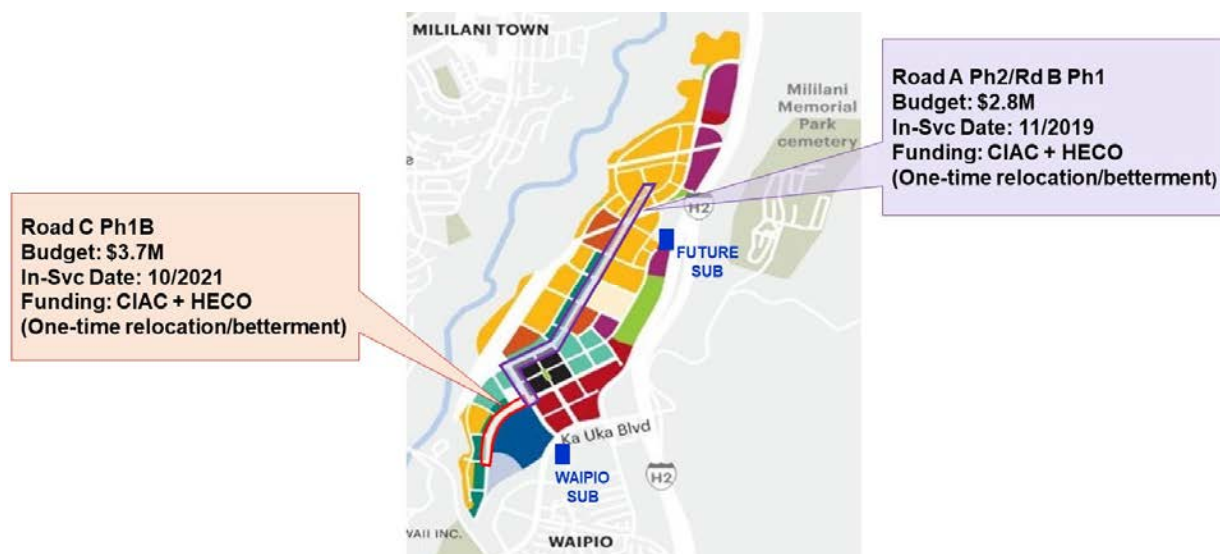


This project involves relocating a portion of an existing line; therefore, the alternative is to remove that line. This means that downstream loads would need to be removed from the grid. Stakeholder consensus in the meeting was that this type of project is not a feasible NWA opportunity. This type of project requested by public works would be put into the non-qualified category in Step 1.

### Waiau-Mililani 46 kV OH to UG Conversion

A customer requested OH to UG conversion projects for betterment in support of the Koa Ridge Development, as shown in Figure J- 7. The scope of work includes installation of OH transitions and UG electrical facilities and then removal of existing OH electrical facilities once UG facilities are energized. The total project cost is \$6.5 million, with the developer contributing the majority of the funding through contributions in aid of construction (CIAC). The Company's cost after the customer's contributions is about \$800,000. In-service dates vary between 2020 and 2021.

Figure J- 7: Waiiau-Mililani 46 kV OH to UG Conversion



Stakeholders agreed that this type of customer-requested betterment OH to UG conversion project is not a feasible NWA opportunity. Customer-requested betterment conversion projects will be put into the non-qualified category in Step 1.

### Waiiau 46 kV GIS Bus Replacement

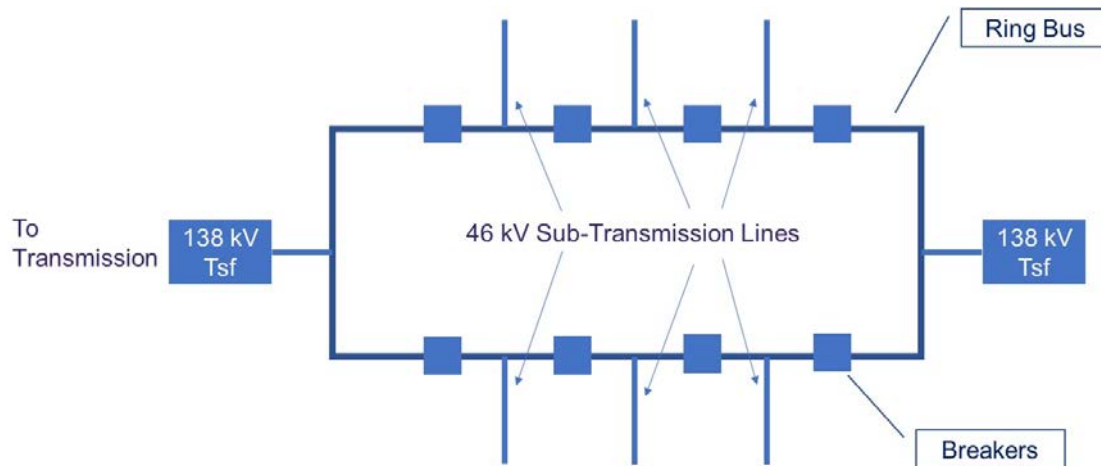
This project is proposed to replace the existing deteriorated 46 kV air-insulated switchyard with a new 46 kV gas-insulated substation (GIS). This major 46 kV switching station provides service to Waiiau, Ewa, Mililani, Pearl City, and Waipahu through eight sub-transmission lines with a total bus load (2018) of 92 MW. Findings from Black & Veatch's *Waiiau 46 kV Substation Engineering Study* dated 2013 are as follows:

- Substation that is well beyond its design life (66+ years in marine environment)
- Bus configuration that creates risk of major outage and is expensive to operate
- Severely corroded steel structure
- Inadequate grounding system creating potential hazard to public
- Aged, obsolete, and unreliable equipment providing unreliable service
- Inadequate housing for modern protective relays

The scope of work includes installing a new 46 kV GIS ring bus (circuit breakers are connected to form a ring, with isolators on both sides of each breaker) and constructing a new 46 kV control house, with provisions for future 138 kV relays, as shown in Figure J- 8. The estimated project cost is \$60 million to \$80 million, with an in-service date of September 2024.



Figure J- 8: Waiau 46 kV GIS Bus



Stakeholder consensus was that this type of aging infrastructure project is not an NWA opportunity because there is not a viable approach to avoid the ring bus and breaker replacement. Also, the 46 kV substation bus provides system benefits by allowing renewable projects and DER to export renewable energy to other parts of the grid in support of Hawai'i's 100 percent renewable objective. As such, this project would be screened out in Step 1.

The three example projects screened out in Step 1, which include line relocation, line OH to UG conversion, or bus replacement of aging infrastructure, represent projects where the alternative is to remove that section of the line or bus. This means that downstream loads would either result in losing a backup source or need to be removed from the grid.

## J.5.2. STEP 2: NWA OPPORTUNITY SOURCING EVALUATION

The case example T&D projects that passed Step 1 screening were discussed with stakeholders in the joint application of the Step 2 evaluation criteria.

### Koa Ridge

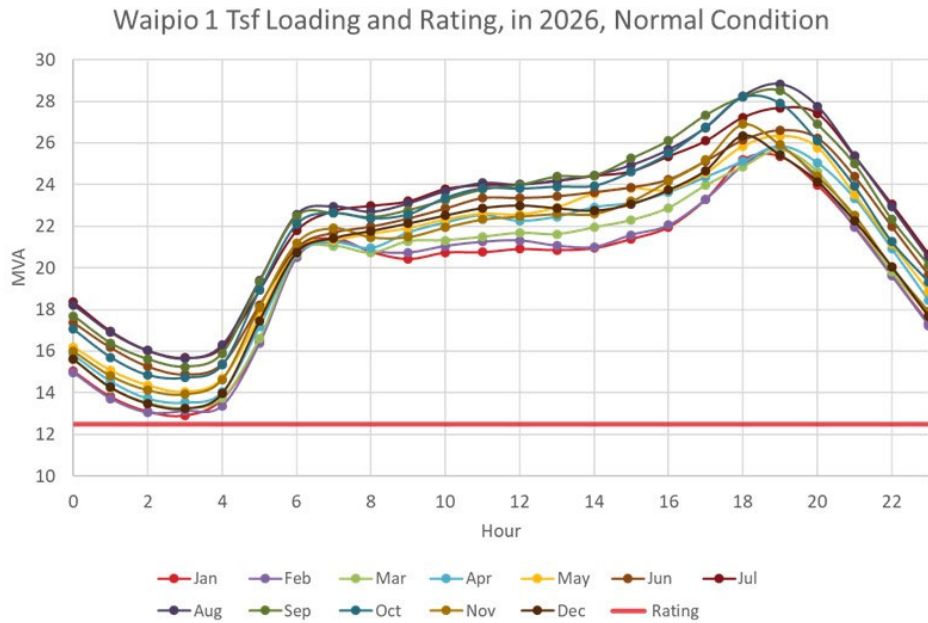
Koa Ridge Development in Central O'ahu near Mililani, to be built by Castle & Cooke Hawai'i, includes 3,500 new homes, a medical center, commercial and light industrial development, parks, and schools. The developer's estimated ultimate load is 43 MW with an initial load of 450 kVA (residential) in 2020. Additional distribution capacity would be needed by 2022/2023 to address new development growth, as shown in Figure J- 9.

Figure J- 9: Waipio Substation and Circuit Load Growth and Transformer Ratings



The load growth will result in an overload of substation transformers under normal and emergency conditions, as presented and discussed with the stakeholders. An example representing the transformer that will see the largest overload under normal conditions is shown in Figure J- 10.

Figure J- 10: Waipio 1 Transformer Overload



The proposed T&D project is the installation of an additional Waipio Transformer #2 and associated equipment at an estimated cost of about \$2.2 million, with an in-service date of 2022. Additionally, to address further development load growth by 2025 would require installation of Waipio Transformer #3 and associated equipment at an estimated cost of about \$2.1 million.

The Koa Ridge project is a qualified NWA opportunity that falls into the “system expansion” category that can be addressed by a distribution capacity deferral service. The following is the collective assessment of the DPWG stakeholders:

- Performance Requirements: Performance requirements are a potential challenge given the long-duration and high-magnitude overloads, and given the results of the Soft Launch (see Section 5.3) it is uncertain if a procurement will be successful (Yellow).
- Timing: The in-service date is more than 2 years away (Green).
- Forecast Certainty: There is a high near-term certainty for the 2022 need because the housing development is underway (Green); the 2025 load growth need is less certain (Yellow).
- Market Assessment: There is an existing substation with a customer base that may be used to provide NWA under a procurement (Green).
- Economic Assessment: The T&D project cost is greater than \$1 million (Green).

Track	Grid Need	Performance Requirements	Timing	Forecast Certainty	Market Assessment	Economic Assessment
1	Koa Ridge Ph 1 - Waipio Tsf#2	Yellow	2022	Green	Green	\$2.2 mm
2	Koa Ridge Ph 2 - Waipio Tsf#3	Yellow	2025	Yellow	Yellow	\$2.1 mm

At this time, the Company recommends pursuing NWA procurement in 2020 (Track 1) for an alternative to Waipio Transformer #2, recognizing the potentially challenging performance requirements. Note that 2020 forecasted load growth may be impacted by the 2020 COVID-19 economic impacts, resulting in a delay of the forecasted need.

The 2025 need for Waipio Transformer #3 is too uncertain, and there is sufficient time before the potential need. Therefore, the Company will not pursue an NWA procurement at this time, but instead will evaluate a future procurement opportunity in the next planning cycle or consider a new construction-oriented DER (including EE) program to mitigate additional load increases at the Koa Ridge Development.

### Ala Moana Transit-Oriented Development

New residential/commercial projects have been proposed in the Ala Moana area due to the Transit-Oriented Development (TOD) Special District Design Guidelines, which promote “intense and efficient use of land” near the rail stations, as shown in Figure J- 11. The Company has received six TOD-related service requests, and two more appear to be in development per news reports and feedback from the City.

Figure J- 11: Ala Moana Area TOD



The Ala Moana TOD area is between Kalakaua and Ward Avenue along the Kapiolani Boulevard corridor and is served by a 25 kV distribution system fed by the Kamoku Substation (near Iolani School) and Kewalo Substation (in Kakaako). With the projected loads based on service requests, contingent overloads during emergency conditions will occur as illustrated in Figure J- 12 and Figure J- 13. This need has not yet had a T&D solution identified, scoped, or estimated. This was discussed in the context of an example of an emerging need that will likely be ripe for NWA procurement in 2020 to 2021.

Figure J- 12: Kewalo 6 and Kamoku 10 Circuit Loading (Emergency Condition)

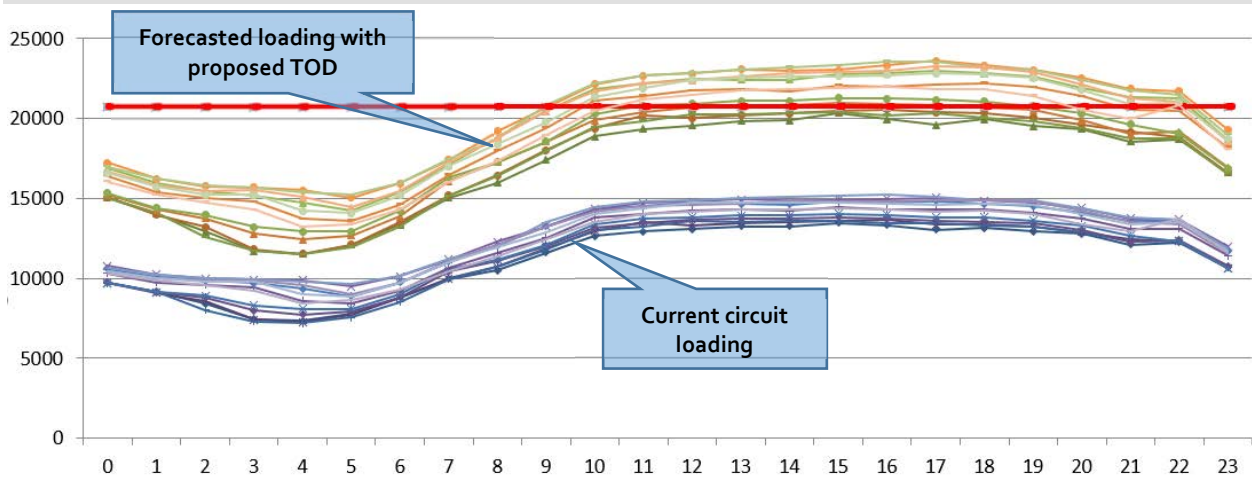
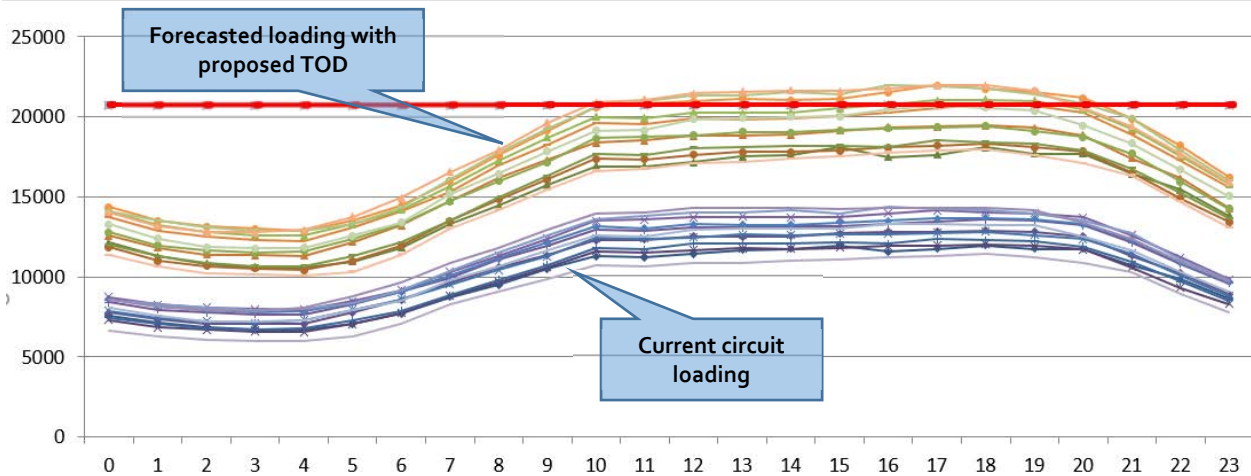




Figure J- 13: Kewalo 5 and Kamoku 9 Circuit Loading (Emergency Condition)



The Ala Moana TOD project is a qualified NWA opportunity that falls into the “system expansion” category that can be addressed by a distribution capacity deferral service. The following is the collective assessment of the DPWG stakeholders:

- Performance Requirements:
  - Kewalo 6 and Kamoku 10 circuit loading requirements are a potential challenge given the long-duration and higher-magnitude overloads (Yellow).
  - Kewalo 5 and Kamoku 9 circuit loading requirements involve a magnitude of 5 to 6 MVA and a duration of less than 6 hours (Green).
- Timing: The in-service date is more than 2 years away (Green).
- Forecast Certainty: Although service requests have been submitted, the potential for the full forecasted load to materialize is uncertain (Yellow).
- Market Assessment: The development area is located in the dense urban core, with many potential customers to provide services (Green).
- Economic Assessment: No T&D wires solution is determined yet, but it is likely to be greater than \$1 million (expected Green).

Track	Grid Need	Performance Requirements	Timing	Forecast Certainty	Market Assessment	Economic Assessment
2	Ala Moana TOD					Expected >\$1 mm

The Ala Moana TOD need has not yet reached a maturity in terms of the certainty of the need; correspondingly, a T&D wires solution has not yet been developed. In this case, the opportunity will be reconsidered in the next planning cycle based on further information on the need, including refinement of performance requirements, timing of in-service date(s), and scoping and estimation of a wires solution.

### J.5.3. STEP 3: ACTION PLAN

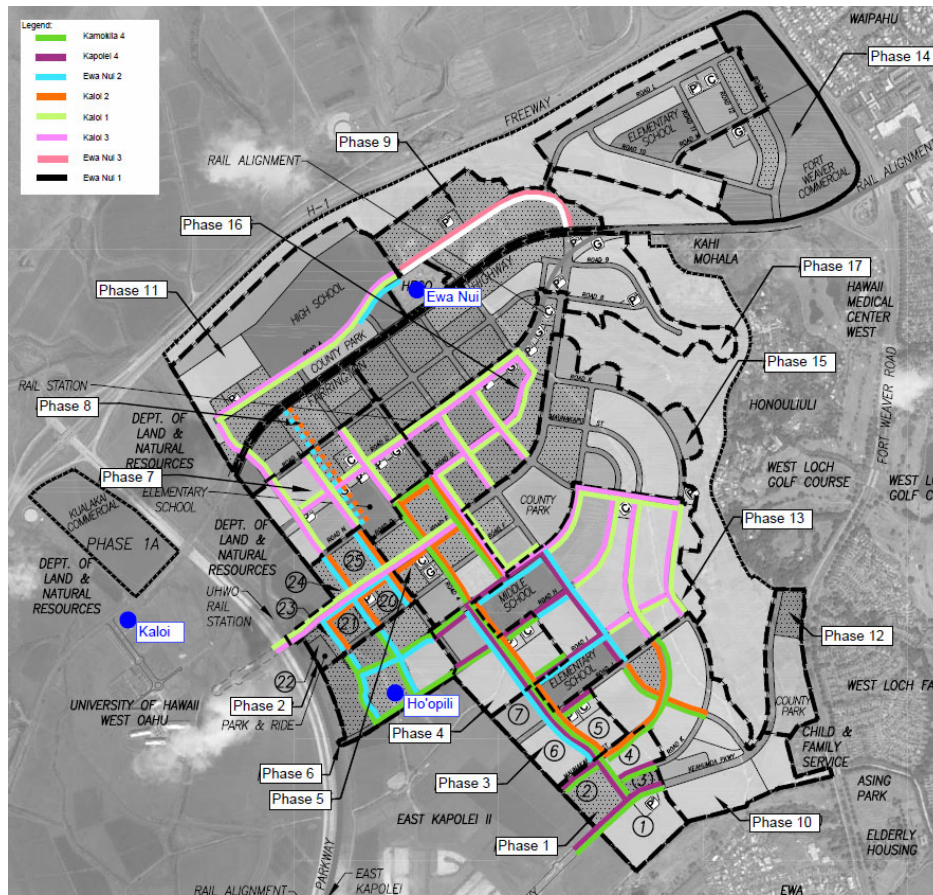
The Company conducted a Soft Launch to demonstrate the grid needs assessment, NWA opportunity evaluation, sourcing process, and solution evaluation methods for NWAs by using real-world examples. These examples also allowed the Company to gain experience identifying needs for resource choices while being subjected to an evaluation and construction time line. The lessons learned in the Soft Launch are being used to help inform development of the full-scale IGP planning and sourcing effort.

The Company identified two T&D NWA opportunities to source through a competitive procurement as part of the IGP Soft Launch. These two opportunities were effectively identified as Track 1 opportunities to pursue for procurement. The following discussion summarizes the opportunities and results.

#### **IGP Soft Launch RFP – Ho‘opili and East Kapolei Area**

Ho‘opili is a mixed-use master-planned community developed by D.R. Horton in west O‘ahu located north of Ewa Beach and east of Kapolei, as shown in Figure J- 14. The plans for this new community include 11,750 new residential homes, 7 community and recreation centers, over 200 acres of commercial farms and community gardens, up to 3 million square feet of commercial space, and 5 Department of Education public schools. In addition to Ho‘opili, there are currently over 20 additional customer service requests in the area with completion dates within the next few years. Due to an estimated load growth of 83.4 MWA, overloads under contingency conditions are forecasted to occur in 2022, with normal overload conditions beginning in 2023.

Figure J- 14: Planned Ho'opili Development



The load growth will result in an overload of substation transformers and distribution circuits under normal and emergency conditions, as shown in Table J - 1 and Table J - 2. From these overloads, two NWA opportunities were identified. The first NWA opportunity was to defer the Kapolei 4 Circuit Extension project with a commercial operation date (COD) of February 1, 2022. The second NWA opportunity was to defer the Ho'opili Substation project with a COD of January 1, 2023.

Table J - 1 Summary of Normal Overloads

Deferral Opportunity	Equipment	MW Peak	Operational Date	Delivery Months	Delivery Hours	Duration (Hr)	Max # of Days	MWH
Ho'opili Substation	Kalo 1 Tsf	4.7	Jan 2023	Jan-Dec	1PM-11AM	10	365	21.5
	Kalo 3 Ckt	0.3	Aug 2023	Aug-Oct	7PM-9PM	2	69	0.4

Table J - 2 Summary of Contingency Overloads

Deferral Opportunity	Equipment	MW Peak	Operational Date	Delivery Months	Delivery Hours	Duration (Hr)	Max # of Days	MWH
<b>Kapolei 4 Circuit Extension</b>	Kapolei 2 Tsf	3.5	Feb 2022	Jan-Dec	5PM-11PM	6	365	11.4
<b>Ho'opili Substation</b>	Ewa Nui 2 Ckt	5.1	Jan 2023	Jan-Dec	11AM-12AM	13	365	30.9
	Kaloi 1 Tsf	9.7	Jan 2023	Jan-Dec	6AM-8AM, 9AM-12AM	17	365	62.8
	Kaloi 3 Ckt	2.6	Jan 2023	Jan-Dec	5PM-11PM	6	365	8.5
	Kamokila 4 Ckt	1.0	May 2023	Jan-Dec	5PM-10PM	5	226	2.9

Figure J- 15 shows the loading of the peak day by month on the Kaloi #1 Transformer in the year 2023. Figure J- 16 shows the associated grid need for Kaloi #1 Transformer. These, along with graphic representation for all other overloads, were identified in the RFP, Appendix J, for NWA services for the Ho'opili Area, dated November 8, 2019.

Figure J- 15: Kaloi #1 Transformer Loading - Monthly Peak Day in 2023

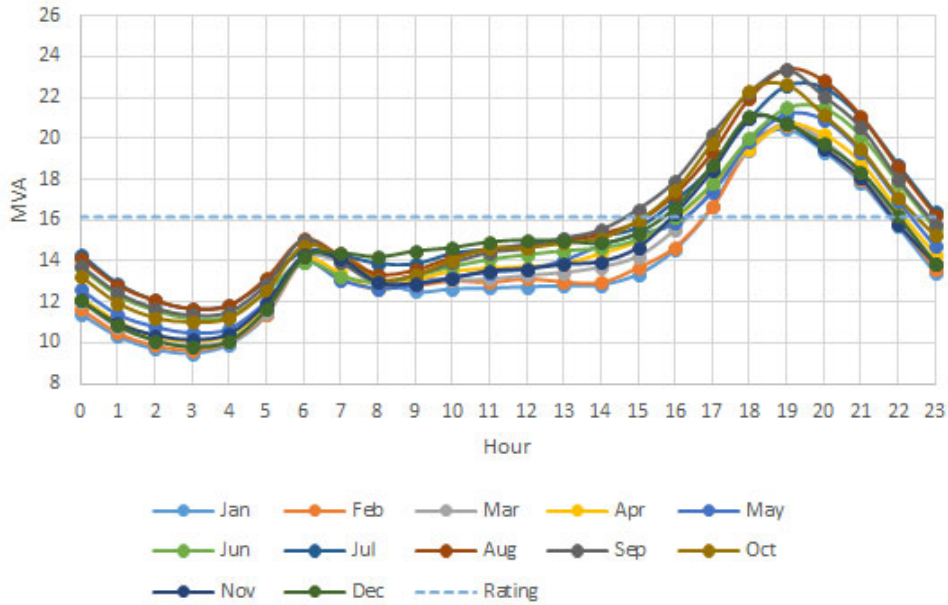
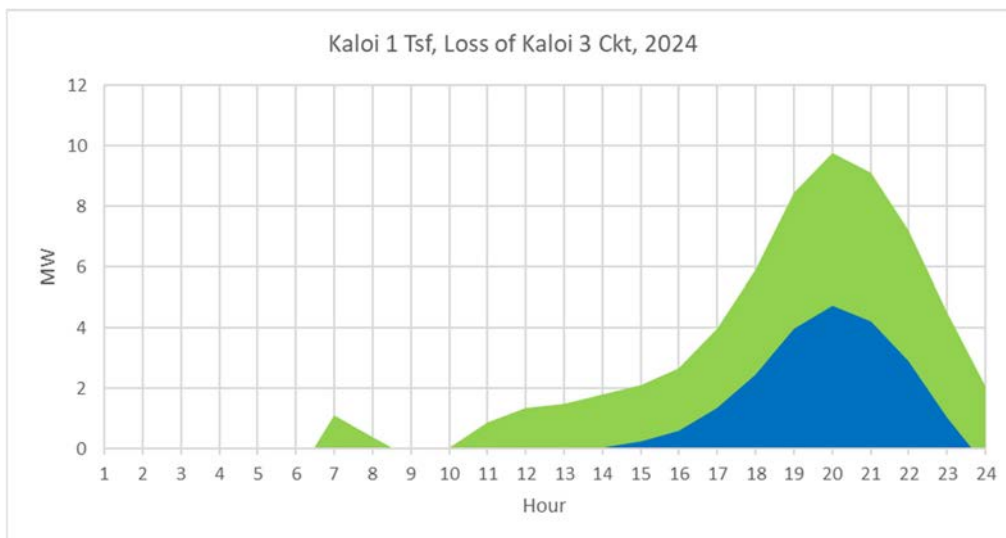




Figure J- 16: Kaloi #1 Transformer Overload



The most cost-effective T&D project proposed for comparison to an NWA solution is the construction of a new substation site and associated equipment located in the Ho'opili development. This would result in minimal distribution circuit installation costs because of the location of new loads to serve. Estimated costs for this project are approximately \$12.7 million with provisions for up to four 46-12 kV, 10/12.5 MVA distribution transformers to allow for future load growth in the area.

The IGP Soft Launch RFP process resulted in low response from the market. Because of insufficient response to the RFP to meet the performance and operations requirements for either of the deferral opportunities, the Company, in consultation with the Independent Observer, decided not to move forward with the IGP Soft Launch RFP. As a result, the Company is moving forward with the identified traditional solution. As indicated in Hawaiian Electric's *Ho'opili Area Study* dated 2019, the proposed project will allow for the timely installation of critical infrastructure to the electrical system, which will provide necessary capacity to serve projected loads and provide essential reliable power under contingency conditions.

Although a traditional solution will be initially pursued for the Ho'opili area, future NWA opportunities remain to enable Ho'opili's growth. The Company will evaluate the viability of a programmatic DER effort for the Ho'opili and East Kapolei area to reduce longer-term needs for distribution upgrades in the area. The Company will reevaluate options as load grows (around 2024 or 2025) and will determine if future NWA opportunities become available. The Company has also recognized the challenge and need of exploring ways to cost-effectively mitigate the impact of large new real estate development loads.

The Company was one of the first, if not the first, to procure for a distribution reliability (back-tie) service nationally and gained valuable experience while proceeding through the Soft Launch process. The Company will continue to improve the IGP process going forward and will

conduct future NWA procurements for distribution opportunity based on lessons learned from the Soft Launch. Some lessons learned that will be applied to the IGP process include the following<sup>141</sup>:

- Leverage the NWA evaluation framework developed by the DPWG to determine opportunities best suited for procurements
- Continue to pursue market solutions to acquire least cost, best fit solutions for customers, but consider tariff and program options to complement procurements
- Continue discussion in examining opportunities to capture multiple services from resources at longer-duration contracts
- Pursue standard form RFP for NWAs and streamline the process for short lead time/near-term needs.

---

<sup>141</sup> March 9, 2020, DPWG Presentation Slides

[https://www.hawaiianelectric.com/documents/clean\\_energy\\_hawaii/integrated\\_grid\\_planning/stakeholder\\_engagement/working\\_groups/soft\\_launch/20200309\\_igp\\_soft\\_launch\\_wg\\_presentation\\_materials.pdf](https://www.hawaiianelectric.com/documents/clean_energy_hawaii/integrated_grid_planning/stakeholder_engagement/working_groups/soft_launch/20200309_igp_soft_launch_wg_presentation_materials.pdf)

# Appendix K. Technical Advisory Panel Review

---

## K.1. REVIEW OF MODELING METHODS RECOMMENDATIONS AND PLANNING CRITERIA

The following independent review from the Technical Advisory Panel was filed with the Commission on June 1, 2021.

Subject: Docket No. 2018-0165  
Instituting a Proceeding to Investigate Integrated Grid Planning (“IGP”)  
Hawaiian Electric Stakeholder Meeting to Address Order No. 37730 and  
Ulupono’s Comments on Modeling Approaches

### 1. Background/Timeline

On May 21, 2021 in preparation for the May 25 meeting of the Technical Advisory Panel (TAP) and Hawaiian Electric Company (HECO, Company) staff, read ahead materials were distributed to TAP members for review. These materials including a Power Point presentation(v2) and a memo to HNEI (v2) and are included here as Appendix 1 and Appendix 2. This memo has been developed utilizing (and where appropriate duplicating) the materials provided in the memo to HNEI with additional comments from TAP reflecting input solicited during a May 25, 2021 meeting between TAP and the Company. The approximate timeline for development of this response is as follows:

- April 14, 2021 – Release of Order No. 37730 *Directing Hawaiian Electric to File Revised Forecasts and Assumptions.*
- April 27, 2021 - The Company met with the Parties and Stakeholder Council, with some members of the TAP in attendance to discuss its current modeling approaches and how it differs from Ulupono’s, the tradeoffs between approaches, and which is preferred by the Parties, TAP, and stakeholders. Members of the HNEI team were in attendance. Concluding this meeting, the HNEI team, in support of TAP, asked HECO for additional clarification on the MODELS and Process flow
- May 7, 2021 – HNEI received slide deck from HECO with initial process flow showing iteration of the models.
- May 18, 2021 – HNEI, as a result of concerns the process flow provided by the Company on May 7, believed that the information provided was not sufficiently explicit to support

the TAP review; HNEI, in support of TAP, submitted an alternative grid-analysis model flow chart and supporting detail to the Company.

- May 19, 2021 – The Company provided a modified Power Point to HNEI that, with minor modifications, adopted the suggested process flow; and including additional slides intended to facilitate that questions being directed to TAP. HNEI returned the May 19 slide deck to HECO with very minor suggestions to the process flow/model charts and suggestions for clarification of the questions to be posed to TAP.
- May 21, 2021 – The HNEI suggestions were adopted and the final slide deck and “memo to HNEI (v2)” were distributed to the TAP members ahead of the planned May 25, 2021 meeting.

## 2. May 25, 2021 TAP meeting: Overview

As stated above, the material included in Appendices 1 and 2 were distributed to TAP members ahead of the May 25th meeting. The meeting was held on-line between 10AM and 1PM HST. Including the Chair, five TAP members joined the meeting although some had to leave the meeting intermittently due to other commitments.

TAP participants included:

- Rick Rocheleau
- Andy Hoke, NREL
- Kevin Schneider, PNNL
- Jeff Burke, APS
- Aidan Tuohy, EPRI

Others in attendance:

- HNEI Support: Terry Surlles, Matt Richwine
- HECO: Marc Asano, Chris Lau, Colton Ching, Earlynne Maile, Kenton Suzuki, Dean Oshiro, Robert Uyeunten, Therese Klaty, Dan Lum, Anne Fuller, Ken Aramaki, Li Yu
- HECO Support: Paul DeMartini, Sean Morash, Jeremy Laundergan

A substantial amount of time was allocated to discussion of the process flow/modeling tools for IGP analysis (Slides 3-9, Appendix 1). This was followed by discussion of a number of general modeling questions (Slide 12 and 13, Appendix 1). The meeting concluded with additional discussion of the merits and drawbacks of Ulupono's suggested approaches and HECO's response to these suggested modeling tactics (Slides 15-18, Appendix 1). Specifically, the TAP responded to the first three of the following Ulupono suggestions:

- Allow RESOLVE to optimize the amount of storage needed for both standalone and paired with solar PV sites, rather than require exactly four hours of storage with utility scale solar,

- Use alternatives to the proposed Energy Reserve Margin (“ERM”) calculation or adopt a reserve margin in later years that is tied to a reliability analysis,
- Assume batteries and curtailed renewables will be able to provide virtual inertia when needed,
- Assume 30-year contracts as the life of the Solar PV system or assume 20-25 with 5-10 year extensions at lower costs.

The discussion of the TAP response is covered in Sections 3 through 7 below. Section 3 summarizes the TAP discussion on the suggested model process flow, including summarizes of TAP discussions of the general questions posed in Slides 12 and 13 in Appendix 1.

Sections 4 through 6 summarize TAP review of the specific issues raised by Ulupono. Each of these Sections include a short summary of the Ulupono suggestions followed by:

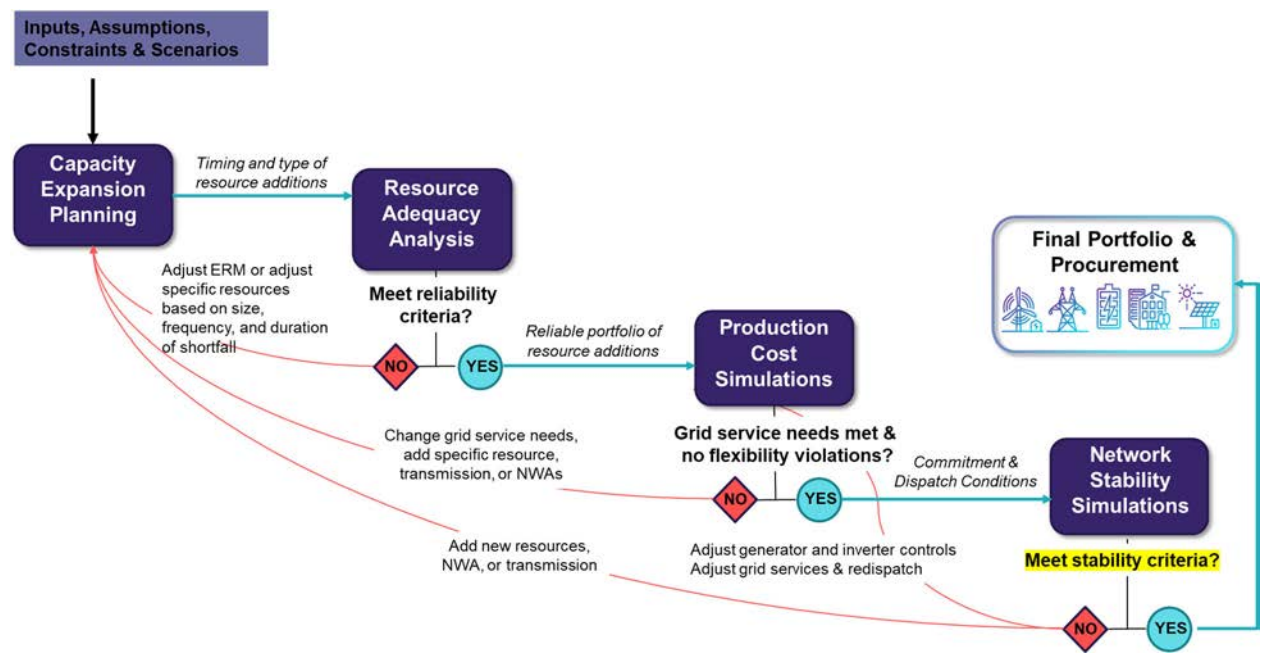
- a. a summary of the proposed Hawaiian Electric approach (as provided in the Memo to HNEI, (v2), provided to the TAP);
- b. additional stakeholder comments and tradeoffs (Company summary of stakeholder comments provided in the Memo to HNEI, (v2), provided to the TAP);
- c. a short statement of areas of agreement and recommendations (as provided in the Memo to HNEI, v2, provided to the TAP); and ,
- d. a summary of the TAP review of the above materials presented during the May 25, 2021 meeting. Sections a, b, and c of Sections 4 – 6 are taken verbatim from the HECO memo to HNEI, (v2), Appendix 2.

### 3. Model Selection and Process Flow Chart

At various time during the IGP process, the Technical Advisory Panel and separately, the HNEI team, have raised concerns regarding the lack of fidelity in HECO’s description of the selection of models for analysis and a perceived overreliance on RESOLVE for portfolio planning. While Company presentations did show an iterative process between RESOLVE and PLEXOS, the details of the use of these tools and the use of other modeling tools for issues such as resource adequacy was unclear. HECO’s materials did not explicitly state the objective for the use of each model including; (a) a description of the key inputs and outputs used for each model, (b) how information was passed between the models, or (c) how feedback loops would be triggered and evaluated. The lack of a clearly defined modeling process and flow - recognizing the interdependencies of each modeling task - raised the concern that the IGP portfolios could result in unreliable or overly conservative portfolio plans. It should be noted that this was a significant issue with the prior PSIP effort, which required a manual adjustment to include combined cycle generators for reliability *after* the model optimizations were complete.

The HNEI team, upon reviewing the Ulupono suggestions for modeling, became concerned that lack of common understanding of the input assumptions and outputs of the various modeling efforts was adding confusion to the efforts to reach common ground. The HNEI team reviewed the models and model flow submitted by the Company on May 7th and deemed it insufficient to facilitate review of the process by the TAP. Subsequently, HNEI developed a new model flow chart and then collaborated with HECO to clarify the use of the various models and developed a revised Process Flow. The new Process Flow identifies the objective of each tool, the interdependencies between tools, and the specific steps addressed in feedback loops between models. The top-level process flow slide is shown below. Additional detail for each model was developed and included in the presentation to the TAP on May 25, 2021 (Appendix 1).

Figure K- 1: Revised Process Flow



The TAP agreed with the process flow summarized in the above figure. TAP also provided some additional detail in response to HECO questions and/or TAP commentary. These are summarized in the following bullets:

- The TAP initiated a discussion on the use of RESOLVE vs PLEXOS as the screening tool. All parties agreed that both PLEXOS and RESOLVE can be used for capacity expansion, but HECO stated that the ability for RESOLVE to run faster than PLEXOS is a significant advantage given the number of runs that are likely to be required. There was no objection to this position by the Company. However, consistent with the diagram above, it was again noted that RESOLVE provides limited fidelity and should be used only as a technology screening tool. Subsequent determination of reliability, analysis of multi-year weather data, retirements, and avoided costs, etc. requires the use of other modeling tools. It was emphasized more than once that the other models should

be an integral part of the overall process, NOT just a check on the output from RESOLVE.

- During the May 25 meeting, HECO sought TAP guidance from TAP that essentially asked “What is the tolerance used to know when to go back and iterate” and “Is it necessary to always rerun the full process or can estimations serve. TAP did not provide a hard and fast answer to these questions, noting the need for ‘engineering judgement’ and ‘experience’ to determine what needs to be done. While TAP recognizes that engineering judgement can reduce the requirement for the full process to be used for all iterations, TAP recommends that solutions be vetted by the full process before proceeding to the procurement phase.
- The TAP also initiated a discussion that suggested the possibility of putting LOLP in as a hard constraint during the capacity expansion modeling effort. It was noted that some utilities define their resource adequacy needs first, using clearly specified LOLP metrics for every day of the year to develop a reserve margin. Hawaiian Electric uses a 1 day in 4.5 year LOLP planning metric for Oahu. This reserve margin then goes to the capacity expansion model, which solves to meet the required reserve margin. After some discussion, it was generally agreed that this approach may be more appropriate for systems that are less distributed, and less reliant on renewables with short-term battery energy storage than the Hawaii systems, and which experience relatively minor year to year changes because of different resources or outages showing up on different resources in different years. There is additional discussion of the use of ERM with RESOLVE in Section 6, below.
- The question was raised as to whether the proposed Process Flow was adequately accounting for the growth and value of DER. DER growth is not an explicit output of any of the models. TAP conveyed that while not an output, carefully selected scenarios, such as different assumptions about DER, would allow evaluation of the cost/benefit of these technologies. It was again noted that to properly assess and incorporate DER would require use of the Process Flow, not just RESOLVE to ensure that viable, reliable scenarios were being compared. This discussion was broadened some with TAP recommending that before running different scenarios, HECO clearly define the objective of those comparative scenarios before running the models and fully define the process to be used for those comparisons.
- The question was raised in regard to “What cases would be evaluated in network stability? Is it day min/max and evening min/max or others?” The related question was that if inertia and FFR are modeled in both RESOLVE/PLEXOS and a stability tool such as PSSE/PSCAD, which would take priority? HECO stated that they would give priority to PSSE/PSCAD, but if they found the RESOLVE/PLEXOS is adequate, then there may



be no changes. The determination of what cases would be evaluated for network stability was less clear. TAP stated that it was important to put cases in context such as with duration curves and believes this question requires more effort.

- Several times was emphasized by TAP that reliability is critical and “when we think about reliability, we do not want to be short.” This may require prioritizing the near-term over the long-term - because in the near-term we’re not able to change things as much. There is a need to think about this issue as “minimums,” that are required and then looking at the costs of the alternatives for meeting the minimums. Utilities don’t want to get caught short on reliability. While the TAP agreed that there can be advantages to going long and growing into it, it was also pointed out that the time-frame for utilization of these resources must be carefully considered. This is another area, requiring ‘engineering judgement’, not just models.
- There was some discussion of the ability of RESOLVE to handle things like negative pricing. HECO stated that RESOLVE uses “shadow” prices that have a floor at zero. It was acknowledged that negative prices, might result from an oversupply due to things that can’t be controlled. It was noted by one member of TAP that this might obscure an important incentive. The question was left open without clear guidance from TAP.

#### 4. Ulupono #1: Allow RESOLVE to Optimize Paired with Solar Resources

*“For energy, Ulupono says that RESOLVE should be allowed to optimize the amount of storage needed for both stand-alone and paired with Solar PV sites. Allowing RESOLVE to “optimize the amount of storage needed for both stand-alone and paired with Solar PV sites, rather than requiring exactly four hours of storage with utility-scale solar”*

##### a. Hawaiian Electric’s Approach

In the Company’s model, RESOLVE is allowed to build paired PV and battery systems that are either 4-hour or 6-hour duration as well as standalone storage. Standalone storage is allowed to be optimized for both the capacity (megawatt) and energy (megawatt-hour). Specific durations for paired PV and battery systems are assumed to capture the State Investment Tax Credit (“ITC”) rules more precisely. To capture the impact of the Federal and State ITC on paired PV and battery systems, the ITCs are assumed to directly reduce the dollar per kW capital costs input into RESOLVE. For a paired PV and battery system, a fixed duration for storage is assumed to capture the cap on the State ITC on a per system basis. One system is defined as 1,000 kW. The ITC is first applied to the PV and any residual tax credit under the cap is then applied to the battery.



b. Stakeholder Comments and Tradeoffs

In Ulupono's approach, without bounding the storage duration for a paired PV and battery system and allowing it to freely optimize, the State ITC may be overstated in the resource's cost. In Hawaiian Electric's approach, considering only 4-hour and 6-hour durations may be too rigid and may cause a small amount of excess battery investment. Other stakeholders recognized that the RESOLVE modeling efforts are intended to identify the grid needs on a technology-neutral basis. The selected resources in RESOLVE serve as a proxy for those needs. Therefore, the current treatment of the State ITC is reasonable. If the ITC is overstated, that might suggest there are more cost-effective resources. Ultimately the RFP and the market will verify the numbers (i.e., price and appropriate duration of storage).

c. Areas of Agreement and Recommendations

Hawaiian Electric and Ulupono agree that allowing additional paired PV and battery system options in RESOLVE is reasonable. The recommendation is to include paired PV with 2-hour, 4-hour, 6-hour, and 8-hour battery systems.

d. TAP Comments

At the beginning of the discussion, HECO stated that for standalone storage, RESOLVE can optimize capacity and energy separately. For paired PV+BESS projects, to allow different hours of storage (2,4,6,8) in RESOLVE.

TAP agreed that additional analysis in RESOLVE to estimate optimal battery sizes should be conducted but identified some issues to be considered. The TAP stated that the estimation of alternative storage sizing using RESOLVE should be considered an "estimation," recognizing that more detailed reliability, cost and stability analysis should be conducted to guide decision making. TAP also noted that it was important to consider what time frame was being solved for, with consideration of the nearer term being more important. TAP noted that being "long" - meaning that HECO has overbuilt - might make sense for a limited duration (a year or two) to ensure reliability but might not be appropriate if the intent is to solve a 2040 problem with today's storage. Again, there needs to be engineering and operational judgment looking at all aspects of the problem.

Some members of TAP were confused by the stakeholder comment "If the ITC is overstated, that might suggest there are more cost-effective resources. Ultimately the RFP and the market will verify the numbers (i.e., price and appropriate duration of storage)". TAP does agree that it is important to evaluate a variety of options and that the RFP will determine the final price. However, the "appropriate duration of storage" needs to be specified based on the grid needs, both energy and services.

TAP members responded that while it is okay to start with RESOLVE, any conclusions from this model need to be evaluated. Fundamentally, RESOLVE is being expected to do analyses for which it is not designed to do. Explicitly, RESOLVE is not designed for modeling resource

adequacy needs or integration of inverter-based resources which is necessary for storage systems.

## 5. Ulupono #2: Use Alternatives to ERM or Adopt a Reserve Margin that is Tied to a Reliability Analysis

*"While Ulupono looks to Hawaiian Electric for more detailed responses to our initial questions in Exhibit 1\ Ulupono recommends that Hawaiian Electric adopt a reserve margin in later years that is tied to a reliability analysis. Ulupono does not believe it is appropriate to assume that a 30% reserve margin will be needed for the system's load based on the assumption of "poor weather days for renewables." Dr. Fripp notes that poor weather days are already addressed by the requirement that RESOLVE and PLEXOS select resources to keep the power system consistently balanced, including a regulating reserve margin.*

*Including the worst-weather day in the RESOLVE optimization will ensure that the system has a least-cost design that provides enough power at all times. Consequently, it is not appropriate to apply an ERM as an additional, arbitrary mechanism to achieve generation adequacy. We recommend that Hawaiian Electric eliminate the ERM calculation and margin. Alternatively, if there are reliability factors that are not addressed adequately by the hourly energy and reserve balancing in RESOLVE and PLEXOS, Hawaiian Electric should demonstrate that using analysis and data, and should use a more targeted calculation to achieve reliability."*

### a. Hawaiian Electric's Approach

In the IGP process, the Company introduced a new planning criterion called Energy Reserve Margin ("ERM") to satisfy load and plan for a reasonable reserve that can be called upon in emergencies. The ERM planning criterion considers the total firm system capability that is reduced by planned maintenance and outages and increased by hourly dependable capacity ("HDC") of variable renewable resources, shifted load from energy storage resources, and interruptible load, the sum of which must be greater than the load that is increased by the ERM percentage on an hourly basis. The margin provided by ERM is intended to provide reserves to mitigate:

- Loss of largest unit
- Multiple forced outages
- Unplanned maintenance
- Fluctuations in generation from variable resources
- Prolonged poor weather patterns or atypical weather
- Battery failures
- Forecast error

ERM targets are 30% for O'ahu, Hawai'i Island, and Maui and 60% for Moloka'i and Lāna'i. The targets were selected by analyzing historical data. High risk incidents were studied to examine reserves, unit availability, loads, loss of load hours, and frequency of at-risk conditions.

### b. Stakeholder Comments and Tradeoffs

In Ulupono's approach, planning only to include the worst weather day will assume that the worst weather day occurs every year that is simulated and assumes that the worst weather day will also account for unexpected, forced outages or forecast error where load is unexpectedly higher. Ulupono recommends a 7-step process to assess the "optimal" ERM for the system that starts at 0% ERM and increases the ERM percentage until the desired reliability level is reached.

1. Include worst days in time sampling in RESOLVE
2. Count renewables at their full hourly availability in RESOLVE
3. Set initial ERM to 0%
4. Run RESOLVE with current ERM
5. Test the resulting plan with many years of data (e.g., in PLEXOS) – include all possible weather, realistic forecast errors for load and renewables, forced outages for thermal plants and batteries, etc.
6. If shortfalls are found: increase ERM by a few percent and return to step 4
7. Repeat until shortfalls are resolved

Stakeholders felt that in Hawaiian Electric's approach, ERM may be too conservative and lead to an overbuild of capacity. ERM may also favor thermal units in its derivation because loss of largest unit, multiple forced outages, and unplanned maintenance are implicit thermal unit considerations. Ulupono noted that the HDC used to calculate the variable renewable contributions excessively discounts the generation provided by these resources and is not necessary.

At this particular meeting, a TAP member was present and commented that they support transition away from a planning reserve looking at peak to one that assesses hourly load. For reference, Southern California Edison and Community Choice Aggregators have proposed a similar planning criteria to energy reserve margin that examines all hours. Planning reserve margins focused on system peak was based on resource adequacy and loss of load. To meet the reliability criteria, the system needed X% of margin. It would be interesting to link and correlate traditional metrics such as loss of load expectation ("LOLE") with ERM. A large driver of 30% was driven by multiple unit outages. When considering retirement of fossil units, the risk of concurrent outages diminishes. Another stakeholder liked the idea of linking ERM to LOLE.

### c. Areas of Agreement and Recommendations

Hawaiian Electric and Ulupono agree that further study of the ERM criteria is warranted to determine the appropriate level of reliability that should be solved for in the optimization models. Hawaiian Electric proposes to test lower percentages (0%, 10%, 20%) for the ERM target in RESOLVE and evaluate the reliability impact on the resulting resource plans in PLEXOS. A sensitivity analysis will also be performed to remove the HDCs and instead consider

the full production profiles. The Company is also open to having HNEI test the reliability of the various resource plans generated from RESOLVE at different ERM levels using their stochastic resource adequacy methodology.

d. TAP Comments

TAP agrees that HECO is correct to identify a need to change the conventional planning reserve margin used in previous planning efforts with a new methodology that evaluates all hours of the year and chronological operations of the grid. A reliability criterion that only evaluates peak load is inadequate for a system with high percentage penetrations of variable renewables and energy limited resources (storage and load flexibility). ERM is a step in the right direction. If developed and implemented correctly, it may help reduce or eliminate reliability shortfalls that were present in past portfolios without grid modifications.

The TAP also recognizes that capacity planning models requires some 'relatively simple' methodologies to address the many issues impacting reliability including the various reserve margins, renewable variability, and unit outages in order to efficiently analyze the many options available for capacity expansion. TAP agrees that ERM is a reasonable approach to take. However, there should be clarity on how values are reached and how different grid resources are considered in analyses.

That said, caution should be applied to using only RESOLVE to arrive at answers. However accurately the ERM or other methodology selected is, RESOLVE alone does not provide the fidelity needed to determine and validate a cost effective, reliable expansion plan. A number of comments/suggestions in regard to the use of ERM in RESOLVE to determine reliable least cost design are summarized below.

- ERM is a novel approach that does not have precedence in Hawaii or other jurisdictions. As a result, additional information, analysis, and testing is required to ensure that ERM is used effectively in the HECO planning process. In regard to this, HECO has not, to date, provided sufficient information on the ERM to assess the ERM values currently proposed (30% ERM target on Oahu, Maui, and Hawaii or the 60% targets on Molokai and Lanai). In particular, TAP has requested additional information on the calculation of hourly dependable capacity. Recognizing the value of a metric like ERM for use in capacity expansion models and the need to continue progressing down the IGP pathway, the TAP recommends that a) a more complete description of the determination of the current ERM values be developed and made available for review as soon as possible and b) analysis be conducted to determine the relationship between ERM and detailed resource adequacy analysis. The latter is discussed in more detail below. The TAP agrees that engineering judgment is important when going from reliability planning concepts and models to operational reliability.

- Ulupono states “Including the worst-weather day in the RESOLVE optimization will ensure that the system has a least-cost design that provides enough power at all times. Consequently, it is not appropriate to apply an ERM as an additional, arbitrary mechanism to achieve generation adequacy”. The TAP does not agree with this statement. While selection of a broad range of daily operations and best estimates of reserves might provide a closer estimate for capacity growth, final determination of the cost-effective, reliable path forward requires use of all the tools identified as was discussed in detail in Section 3.
- One member of TAP noted that the current ERM equation is flawed because it does not explicitly address unplanned outage rates of fossil generation. The model incorporates uncertainty for maintenance (planned outages) and variability of the renewable resources, but treats fossil generation as “firm capability.” The 30% ERM is then meant to cover unexpected outages of the fossil fleet and load uncertainty. This method is biased in that it assigns reliability risk to variable renewables, but does not discount fossil generation which is treated as perfect capacity.
- As stated above, there is agreement that a metric for RESOLVE is needed, but it should be allowed to evolve and change as new information and subsequent process steps are run. TAP recommends that a plan be developed to conduct the analysis to determine the relationship between ERM and detailed resource adequacy analysis as discussed below. This may yield a better value for ERM or a process for ERM determination. At a minimum, RESOLVE should be run with various values of ERM and outputs assessed using detailed reliability tools.

Ulupono has suggested a seven-step plan for assessment of the ERM. The TAP is concerned that this plan is wholly focused on RESOLVE for the determination of the final plan. Weaknesses in this methodology have already been discussed.

In response to the Ulupono recommendation, the Company has suggested a portfolio that meets ERM requirements of 10%, 20% and 30% could be evaluated for a single year and compared to a detailed probabilistic resource adequacy assessment across many weather years and generator outage draws. The results of the different ERM portfolios could be quantified with resource adequacy metrics like LOLE, LOLP, LOLH, and EUE to validate various ERM levels to common RA metrics. The TAP generally agrees with this approach with the recommendation that all parties be involved in the design of the scenarios to be used for this analysis.

- As discussed in Section 3, it was noted that at least some mainland utilities utilize LOLP as a hard constraint (i.e., 1 day in 10 years), utilizing daily outage profiles to develop a reserve margin. Hawaiian Electric previously used a 1 day in 4.5 year LOLP

metric for Oahu. While TAP thought there may be limitations to this process for more distributed systems such as those in Hawaii, a more thorough assessment of this process could be included as part of the evaluation of ERM and reliability.

## 6. Ulupono #3: Assume batteries and curtailed renewables will be able to provide virtual inertia

*"Ulupono recommends that Hawaiian Electric modify their current assumptions for inertia, and assume that batteries and curtailed renewables will be able to provide virtual inertia when needed. ^ Under Hawaiian Electric's current assumptions, it is likely that RESOLVE will be biased and strongly favor large synchronous condensers and thermal generators."*

### a. Hawaiian Electric's Approach

In the IGP process, the Company proposed minimum inertia and fast frequency response ("FFR") requirements that are complementary and work together to support system frequency in an under-frequency event. The minimum inertia plans for a 3 Hz per second change of frequency event and to allow 0.5 seconds for FFR to activate. The requirement also considers the loss of the largest generator and the impact of legacy distributed PV trip settings. Inertia requirements based on maintaining 3 Hz per second is a progressive metric as mainland systems will rarely see such fast rates of change of frequency. Historically in Hawai'i, the rate of change of frequency has been lower/slower than 3 Hz per second. Therefore, the minimum inertia requirements have already been minimized to the extent possible.

### b. Stakeholder Comments and Tradeoffs

Ulupono recommends the following:

- Make reasonable assumptions for when inertial response will be available from inverters
  - May be available soon based on literature review and recent commercial experience
  - Possibly earlier for grid-scale facilities than DER
- Calculate inertial requirements based on stability studies of power systems with very fast frequency response and virtual inertia from inverters
- Identify near-term, low-cost sources of inertia that can be used until inverter-based inertia is widely available
- Include those assumptions in the RESOLVE modeling
  - The current treatment is arbitrary and likely to result in stranded/unnecessary assets

In Ulupono's approach, virtual inertia, or specifically, grid forming inverters are promising. However, requirements for grid forming inverters are still being studied. Many questions remain concerning the use of grid forming inverters and are current areas of research. Ulupono states that the Company should assume there will be progress within the planning horizon of

IGP and that inertia and frequency response should be provided by a reasonable source, which will likely be inverters in long term plans. Uluono does not object to the use of synchronous condensers for other critical services such as system protection and fault current, only to omitting inverter response which may reduce the needs for synchronous condensers.

A stakeholder for a large customer mentioned that they have concerns regarding protection. The amount of inverter-based short circuit current may cause significant cost and possible reduced reliability. Other customers with large campuses or facilities would need to adapt their protection.

#### c. Areas of Agreement and Recommendations

Hawaiian Electric and Uluono agree that further study of the provision of virtual inertia is warranted. The inertia assumption in RESOLVE is directional only. Detailed requirements will be determined through stability studies using other software tools such as PSS/E and PSCAD.

Hawaiian Electric proposes that sensitivity analysis be performed in RESOLVE to assess the cost and impact on the resource plan where batteries and curtailed renewables can provide inertia in the model. To mitigate near-term stability issues, where inverter-based resources are expected to make up 95-100% of the dispatched resources for certain hours of the year in 2023-2025, the Company will minimize synchronous condenser investments to the extent possible based on stability studies in PSS/E and PSCAD and repurposing of generation assets to synchronous condensers to minimize costs.

#### d. TAP Comments

Procuring inertia (which is different from FFR) from inverters utilizes nascent “grid-forming” controls technology, where there are many open questions for implementation at scale.

TAP agrees that, in the relatively near future, more inverters providing services such as inertia and/or FFR will become available. A major question remains as to how this will be implemented. Specifically, TAP members raised the issue of, “how will a system operator coordinate FFR from many (perhaps thousands) units?” Multiple members of the TAP noted that just because inverters can provide this service, doesn’t mean that a system operator can implement this in a controllable manner. At this point in time, TAP sees high risk in relying exclusively on inverters (i.e. with no synchronous machines) for inertia required by the Hawaiian grids. However, the TAP did state that with the recent advances, particularly with utility scale inverters, providing services like inertia from inverters can and should coexist with synchronous machine-based technology. This would allow HECO to gain experience in getting the needed services from multiple types of resources. Synchronous condenser conversions are a reasonable and realistic short-term bridge as the inverter technology matures. However, as noted below, the Company should invest in condenser technology only as needed to meet grid requirements and include inverters in their analysis to provide on-going cost comparison.



Ulupono is concerned about how to plan today versus what may be available 5 or 10 years in the future. TAP members agree that there is considerable potential in the technology, and while it has been applied to smaller microgrids or single inverter systems, it remains unproven for complex systems like those operated by the Company. This issue again prompted TAP comment that “reliability is paramount”. From a system perspective, an operator must ensure the proper management and operation of a new technology to ensure meeting grid service needs. TAP members recognize that this technology is developing quickly and should be constantly reevaluated for use.

TAP noted that Ulupono’s comments seemed concerned that inverter technology was being categorically excluded from providing services like inertia. On synchronous condensers, which have been discussed as the primary mitigation, HECO should be clear as to whether these are considered conversions or new units. There’s a big cost difference. New units cost far more and have a 40 years life, which may not be appropriate if they plan to bridge a temporary gap in technology maturity. HECO’s response in the meeting was that they are considering conversions first where possible and are currently performing PSCAD studies of the system that are looking at the grid-forming services from Stage 2 projects.

TAP members acknowledged that Ulupono was not clear whether it’s FFR or inertia. TAP members added that the language and definitions are not clear or uniform across the industry. However, TAP members also acknowledged that Ulupono’s concern may be that a forthcoming solution will be pre-empted by these investments. Thus, some sensitivity on inverters providing these services is appropriate.

The TAP also acknowledges that there can be a distinction between relying on grid forming inverter capability for long-term planning versus short-term procurement. For a planning analysis conducted decades in the future, the assumption of grid forming inverter capability is likely sufficient. However, near term procurement should be more conservative and ensure reliability can be effectively maintained with new technology.

## **7. Assume 30 year contracts as the life of the Solar PV system**

*“The current contract term Hawaiian Electric assumes for renewable and storage technologies is 20 years. Noting that recent Power Purchase Agreements (“PPAs”) are most often approved for 20-to-25-year terms, Ulupono recommends that Hawaiian Electric assume a 30 year PPA term or consider a lower cost replacement resource to be available at the end of the 20 year contract for an additional five to ten years. This is an important issue as assuming 20-year contracts with full cost replacement needed after 20 years would effectively overstate the cost of solar.”*

### a. Hawaiian Electric’s Approach

In the IGP process, the power purchase agreements (“PPAs”) signed with independent power producers (“IPPs”) were assumed to terminate at the end of the contract term to allow the RESOLVE model to re-optimize grid needs when contracts end. New PV and wind resources



were assumed to have 20 year term lengths, consistent with the recent Stage 1 and 2 RFP projects.

#### b. Stakeholder Comments and Tradeoffs

Assuming Ulupono's preference for 30-year contracts, extending existing IPPs may not allow the RESOLVE model to re-optimize in the future when grid needs have changed. Assuming Hawaiian Electric's approach to end PPAs at the end of their term, there could be missed opportunities from extensions of existing IPPs that could be lower cost than requiring a new resource to be built. For new resources, longer contract terms, from 20 years to 30 years, would allow for a lower contract cost and to better match the contract term to the expected service life of the resource. Ulupono asserted that when an existing IPP reaches the end of its 20-year contract, the Company may not receive significantly lower pricing if the contract were renegotiated for another 10 years.

A stakeholder commented that the market provides financing for solar and storage projects over 35 to 40-year terms. Also, assuming battery warranties were 15 years, within a 20-year contract, the batteries would be replaced in year 15 and still have 10 years of life remaining when the 20-year contract ends.

Another stakeholder did not favor long-term contracts because it may prevent customers from realizing the benefits of declining technology costs. A stakeholder commented that asking communities to host longer term projects at 40 year terms may potentially span 3 generations.


#### c. Areas of Agreement and Recommendations

For long-term planning purposes, Hawaiian Electric and Ulupono agree that new PV and wind resources can assume a 30-year term. Stage 1 and 2 RFP projects will also be extended at 50% of their current lump sum costs for a total term of 30 years. Existing PV and wind resources will continue to be removed from service at the end of the contract term.

d. TAP Review – TAP did not review these recommendations due to time constraints.

---

## K.2. TRANSMISSION PLANNING CRITERIA REVIEW

This section includes the TAP Transmission Subgroup's feedback on the Transmission Planning Criteria, which has been revised and included in Appendix F. Feedback incorporated into this revision is denoted with this icon (with applicable section number below): 

###

The Company will continue to seek guidance and input as needed from the TAP to continue refining future revisions of the criteria.

## IGP TAP Transmission Subgroup

Feedback on Transmission Planning Criteria

10/8/2021

This feedback to HECO is based on HECO's slides and presentation on 10/4/2021 related to their transmission planning criteria.

As with all TAP feedback, please consider these comments as recommendations – the final choices are yours of course. And some of these topics are quite complex, so the few sentences included here just scratch the surface and hopefully point in a direction we think might be helpful.

**TAP members attending:** Andy Hoke (NREL, Chair), Debbie Lew (ESIG), Matt Richwine (Telos/HNEI), Deepak Ramasubramanian (EPRI). Not able to attend: Dana Cabbell (SCE)

**HECO presenters:** Ken Aramaki, Li Yu, Addison Li, Marc Asano, Chris Lau, Leland Cockcroft, Lisa Dangelmaier

TAP feedback and comments are divided into three categories:

1. Informational – no action needed.
2. Suggest revising planning criteria before November submission deadline.
3. Consider feedback for future portions of the IGP process (after the Nov deadline).

TAP comments during meeting and HECO responsesF.1.7  
F.2.7  
F.3.7

The damping ratio criteria and the criteria on control stability can be combined into a single category called "system stability criteria". This can generally include criteria related to stability margins in addition to damping ratio. These criteria will likely need to evolve over time as the industry learns more about operation of high-IBR power systems, and so HECO's planners should retain some flexibility to apply case-by-case judgement and incorporate new learnings.

The 3% damping ratio requirement is borderline low – oscillations with 3% damping can persist for some time. IEEE P2800 requires individual interconnected IBRs to have damping of at least 30%. At the same time, in a very high-IBR system it may be difficult to maintain high levels of damping. Some room for transmission planner judgement will be needed. Damping ratio requirements can be periodically re-evaluated as you learn more.

It is good to quantify damping ratio, as HECO proposes. This can be done not just using small signal models but also using other methods that can more easily be applied during the planning process, including:

- Quantifying the effective damping ratio of simulation or measurement traces (e.g.  $f$ ,  $V$ ,  $P$ ,  $Q$ ) using techniques such as the matrix pencil, Eigen Realization, or variable

[projection methods](#). These methods are mature. NREL and EPRI can provide code/scripts to evaluate these damping ratios.

- Small perturbations can be injected into a black-box IBR model, and the resulting response can be used to generate a Bode plot of the IBR impedance at various frequencies. The same technique can be applied a the IBR POI, and the two Bode plots can be used to estimate the magnitude and damping of any resonances of the IBR-grid system. [This method](#) is emerging. NREL can provide scripts/code for it if desired.
- Small signal state space models of the system and its elements can be derived using measurement-based perturbation approaches to complement the Bode plots that are developed. These small signal state space models can be leveraged to identify locations and regions of interest with respect to damping and resonance. This method is also emerging. EPRI can provide scripts/code for this approach, if desired.

What is the threshold for weak grid conditions? (I.e. what is the threshold to require a more detailed study?)

- HECO response: We are considering all buses weak for forward planning purposes.
- TAP follow up: That is reasonable at most buses, though there are likely some exceptions, for example the AES bus. Of course that may change as the system evolves and more buses become “weak”. In addition, an IBR at a stronger bus may still have important impacts on grid stability, so it makes sense to treat all large IBRs as needing detailed study, at least until the industry learns more about interconnecting new IBRs in high IBR systems. In addition, the TAP recognizes the current industry consensus that SCR and WSCR metrics cannot fully capture IBR oscillatory dynamics may come into play.

Is there a size limit on IBRs that need detailed study?

- HECO response: Currently all transmission-connected resources require detailed study. Distribution-connected resources follow a different process. Larger ones may require detailed study.
- TAP follow-up: [Be careful about making a requirement only on transmission. Developers may try to connect large systems to distribution to avoid detailed study.](#)
- TAP follow-up: Small developers with small projects may push back against requiring PSCAD models. But in the case of Hawaii, it is defensible from a technical perspective, especially considering the future state of the system in a few years.

How can HECO let developers know where substations will be available, especially when interconnecting many projects at one location/REZ?

- HECO response: We will provide developers information on available locations. In the future, with REZ, we will target procurements at REZ zones if selected by the IGP process.



The requirement for inertia and frequency response could be interpreted to exclude fast inverter-based frequency response. The TAP suggests changing “shall carry sufficient inertia and frequency response reserves” to “shall carry sufficient, fast and timely delivered frequency response (including some combination of rotating machine inertia, frequency response reserves, and inverter-based frequency response capabilities)”.

The phrase “any aggregate loss of DER” could be misinterpreted to include even unreasonable amounts of lost DER, though we understand that is not the intent. We suggest changing “any aggregate loss of DER” to “expected aggregate loss of DER”.

Incorporate expected aggregate loss of DER into frequency response analysis. (Appears this is already being done.)

Look into potential loss of DER on ROCOF. Look into potential momentary cessation of DERs.



F.1.7  
F.2.7  
F.3.7

The TAP suggests including fault scenarios in the studied contingencies, not just generation loss. This can be captured by studying “credible contingencies” instead of just “loss of largest generating unit”.

What level of UFLS is acceptable?

- HECO response: Oahu target is no UFLS. Other islands’ target is no more than 1 UFLS block.

Make sure the studied conditions are communicated from Planning to Operations. For example, if the system needs x MW of reserves or if a specific unit needs to have X MW of headroom to mitigate a contingency, operations needs to know about that.

At SCE, the maximum duration for emergency conductor rating use is 4 hours on typical Hawaii transmission voltages. Some other utilities use significantly smaller durations. The duration should be based on physical mechanisms that may lead to conductor failure or other unsafe conditions, as well as on the ratings and parameters of the conductor. We suggest understanding the basis for the duration and selecting a value based on an engineering justification. Operators will need to know what duration was studied.

Do you use any automatic post-contingency actions or remedial action schemes? Some utilities prohibit such actions and others use them a lot.

- HECO response: Not currently, aside from UFLS or UVLS. These are theoretically attractive, but extremely complicated and rely heavily on communications, so we lean towards manual responses.
- TAP follow on: A fast IBR runback scheme may be a feasible automatic action to consider.

HECO asks whether PFR and non-contingency reserves should be set to zero in T-planning studies. TAP Response: A conservative planning process would set PFR and non-contingency

reserves to zero unless using probabilistic transmission planning methods. However, this may be overly conservative in some cases, so it would be preferable to examine the impacts of broad assumptions such as this one (i.e. run key cases with and without the assumption) to learn how important they are. Assumptions on reserves may also depend on the purpose of the study. Also see the feedback about making sure the planned level of reserves is communicated to Operations.

- TAP follow on: Are the four planning scenarios enough to inform operations? What about times with storage at high/low SOC, for example? Recent CA shortfalls did not occur at peak load. You can learn which scenarios are important from chronological dispatch.



F.1.8  
F.2.8  
F.3.8

- HECO response: We do consider scenarios beyond the basic four, including full/empty SOC, units on maintenance, and loss of DER due to weather. **We can add language on this.** The purpose of the study may also influence which scenarios are studied.


#### Other TAP comments post-meeting:

As requested, here are some references on probabilistic transmission planning criteria for consideration:

- Jim McCalley of Iowa State University has been working with EPRI and MISO on probabilistic transmission planning. Two presentations are attached.
- Probabilistic Transmission System Planning [textbook](#)
- Probabilistic Transmission System Planning [article](#) (same author as textbook)
- NERC [Probabilistic Analysis Forum](#). Link contains speaker topics and bios for a past forum. Much of the content appears skewed towards resource adequacy rather than transmission planning, though two speakers from ERCOT and ISO-NE spoke on “probabilistic transmission planning”. Presumably the NERC lead, John Skeath, could provide more information.
- Case Studies on Risk Assessment for Transmission and Other Resource Planning ([NARUC Report](#)).

---

### K.3. SYSTEM SECURITY METHODOLOGY REVIEW

This section includes the TAP Transmission Subgroup’s feedback on the System Security Methodology, which is described in Section 3.3.1. Feedback incorporated into this revision (or concurred with) is denoted with this icon (with applicable section number below): 

###

The Company will continue to seek guidance and input as needed from the TAP to continue refining future revisions of the criteria.

#### IGP TAP Transmission Subgroup

## Feedback on System Security Study

10/25/2021

This feedback to HECO is based on HECO's slides and presentation on 10/4/2021 related to their system security study plans.

As with all our feedback, please consider this input as a set of recommendations for consideration – the final choices are yours of course. Some of these topics are quite complex, so the few sentences included here just scratch the surface and hopefully point in a direction we think might be helpful.

**TAP members attending:** Andy Hoke (NREL, Chair), Debbie Lew (ESIG), Matt Richwine (Telos/HNEI), Deepak Ramasubramanian (EPRI). Not able to attend: Dana Cabbell (SCE)

**HECO presenters:** Li Yu, Ken Aramaki, Addison Li, Marc Asano, Chris Lau, Leland Cockcroft, Lisa Dangelmaier

TAP feedback and comments are divided into three categories:

1. Informational – no action needed.
2. **Suggest revising before November submission deadline.**
3. **Consider feedback for future portions of the IGP process (after the Nov deadline).**

### TAP comments during meeting and HECO responses

How is demand response incorporated into the system security study?

- HECO response: It is difficult to estimate how DR will actually perform. We may model only a portion of DR as responding in the study if we are not sure it will all respond at all times. Transmission planners are using data from the DR team to decide how to model DR.

When converting time-series dispatches into security study scenarios, it may be reasonable to use the 90<sup>th</sup> and 10<sup>th</sup> percentiles rather than the absolute maximum and minimum dispatches. Also see several recommendations further below.

Where do the maximum and minimum dispatches for large-scale IBRs come from?


- HECO response: These come from the production cost simulation.

The TAP understands that most IBR vendors are not able to provide grid-forming PSSE models at this time, so EMT study (e.g. PSCAD) is the only available option for simulating system security for now. **We also caution against running only PSSE simulations even if/when good PSSE models of IBRs are available because the positive sequence models such as PSSE are**



3-3-1

known to miss fast dynamics that can arise in high-IBR scenarios. Although newer positive sequence models can catch some of these fast dynamics, complete reliance on only positive sequence models, or complete dependence on only EMT is not recommended. Development and use of advanced screening techniques and solutions can be leveraged to identify scenarios where EMT is to be carried out. At least some of the most critical cases should always be run in the EMT domain.

- HECO response: EMT simulations take a very long time to run. How can we increase simulation efficiency?
- 
3:3:1
  - TAP follow up: Agreed. [Perhaps you can rank the priority of the simulations, to prioritize studying the most critical cases in PSCAD.](#) In addition, feel free to seek guidance on PSCAD studies from NREL or vendors with experience in that. NREL can provide scripts for interacting with large PSCAD models (e.g. setting up dispatches, extracting data, running simulations in batches). Some of this is online as "[PyPSCAD](#)" – we can provide Maui-specific examples.
  - TAP follow-up: Another approach to speed up simulations is to use reduced models. We used the that approach to reduce Maui and enable it to run in real time. There are several model reduction techniques published. [This code](#) can be used to reduce PSSE network models as demonstrated on the Maui system [here](#); the reduced PSSE model can then be used to create a reduced PSCAD model.
  - TAP follow-up: You could also consider running combined PSSE-PSCAD simulations with only certain elements of the system in PSCAD, provided that you can validate that they capture the key dynamics. Electranix has software for that called ETran Plus.
  - TAP follow-up: You can also consider the use of screening tools to determine the region of the network to be modeled in detail, contingency to be studied in detail, location of IBR devices that are to be modeled in EMT, evaluation of instability risk, and reduction of the network to retain the essential dynamic behavior. EPRI can provide screening tools and scripts for this, if desired.

The TAP suggests [avoiding hard requirements on minimum inertia and system strength in longer-term planning.](#)

- HECO response: This is a key topic. [We may create an additional TAP meeting on this.](#)

HECO requests input on alternatives to production cost simulation for generating dispatches and scenarios for study. TAP recommendations include:

[It is recommended to see that the dispatch conditions flow from a production cost simulation so that there is a realistic basis for the dispatch conditions evaluated. It is also recommended that some statistical analysis be performed on the output of the production cost simulation to put the selected \(i.e., 10<sup>th</sup>, 90<sup>th</sup> percentile condition\) in context. We recommended showing the distribution \(i.e., duration curve\) from which the conditions are selected. Also, we recommend selecting other dispatch conditions to](#)



evaluate considering other metrics like max/min MW of DER, max/min generation from the IBR groups/zones, max/min ratio of IBR to synchronous machine MVA, max/min MVA of GFM resources (including synchronous generators and condensers as well as grid-forming IBRs), number of units committed in each hour, headroom available and other factors that could be used to screen for the more challenging cases, etc.. It is of course laborious to add dispatch conditions for evaluation, but you should have enough to be convinced that your subset of cases adequately covers the operating conditions that could be seen. For the first time through considering a very high IBR system, this probably means evaluating more conditions than historically typical in order to understand the trends. Examples of entities that have done this include MISO (Renewable Integration Impact Assessment) and EirGrid (Ireland), both of whom have used PLEXOS with PSS/E. EirGrid has been working with EPRI to examine how to best pick the cases of most interest from a full 8,760 period. EPRI has an Scenario Builder Tool that may help. In addition, NREL's MIDAS tool, which has been demonstrated for Maui Island and WECC use cases, can also be used for this purpose. MIDAS can simulate scheduling, dispatch, and dynamics (in PSSE) for extended periods, including for entire days or weeks if desired, making the link between system economics and system security in high IBR cases.

For future planning cases where IBR controls are not known, proxy IBR models in PSCAD can be used, including:

- [PyPSCAD](#) contains generic PSCAD grid-forming and grid-following inverter models. They are per-unitized for easy scaling and include example systems that are stable including in 100% IBR cases. They don't contain plant controllers but do contain PLL (GFL only), current/voltage controllers, power controllers, configurable droops, programmable trip settings, and DC-side dynamics (to appear soon), etc.
- [GFM-PV](#) contains generic PSCAD grid forming and grid following PV plant models with associated plant controller, inverter level control, and dc side dynamics. Robust fault ride through behavior and stable response in 100% IBR networks have been demonstrated with this model.
- These proxy IBR models are expected to continue to develop as industry matures.

For future planning cases where IBR controls are not known, proxy IBR models in PSSE can be used, including:

- To start carrying out planning studies with grid forming devices in PSS/E, both [GFM-PV](#) along with [REGC\\_C](#) can be leveraged. The positive sequence PSS/E grid forming model's performance has been validated against an OEM's black box EMT model and shown to provide encouraging results. As mentioned previously, use of this model should not completely replace EMT studies, but the model's use can inform the extent to which EMT studies are to be performed.




Other TAP comments post-meeting:

Is protection planning part of the transmission planning process? (This may not be directly related to system security, but we wanted to raise the question somewhere.) At some point we would recommend analyzing how protection settings will work in high-IBR scenarios, in particular protection relying on negative sequence current and overcurrent protection. Overcurrent protection may not be a problem as long as sufficient synchronous machines (generators or condensers) are online, but would likely need to be examined if in a future scenario you consider reducing the use of condensers.

---

#### K.4. DISTRIBUTION PLANNING METHODOLOGY REVIEW

This section includes the TAP Distribution Subgroup's feedback on the previous Distribution Planning Methodology<sup>142</sup>, which has been revised and included in Appendix I. Feedback incorporated into this revision is denoted with this icon (with applicable section number below): 

Note that references to previous section numbers may not align with the revised version in Appendix I. The Company will continue to seek guidance and input as needed from the TAP to continue refining future revisions of the methodology.

### IGP TAP Distribution Subgroup

#### Feedback on Distribution Planning Methodology

10/11/2021

**TAP members:** Kevin Schneider (PNNL, Chair), Dana Cabbell (SCE), Debra Lew (ESIG), and Aiden Tuohy (EPRI).

TAP feedback and comments are divided into three categories:

1. Informational – no action needed.
2. Suggest revising study before finalizing.
3. Consider feedback for future portions of the IGP process.


#### High level comments.





I.6.2

<sup>142</sup> See

[https://www.hawaiianelectric.com/documents/clean\\_energy\\_hawaii/integrated\\_grid\\_planning/stakeholder\\_engagement/working\\_groups/distribution\\_planning/20200602\\_dpwg\\_distribution\\_planning\\_methodology.pdf](https://www.hawaiianelectric.com/documents/clean_energy_hawaii/integrated_grid_planning/stakeholder_engagement/working_groups/distribution_planning/20200602_dpwg_distribution_planning_methodology.pdf)

- The forecast and analysis stages were well documented, but the solution stage is not addressed in the same level of detail.
- 1.6.2  • Where the first two stages have detailed discussions of the process, the solution stage basically states, "Do some analysis and implement the "simplest" solution."
- [Nowhere was protection mentioned. Since this is an essential aspect of distribution systems its omission raises a number of questions.](#)

### General comments

- High level description of the overall planning process, which seems consistent with SCE at the level of detail described.
- An observation within this section is in the last paragraph – HE expects new service requests (load growth) arise during the calendar year and therefore expects the need to modify the forecasts in the middle of the planning cycle. At SCE we also know and expect customers to submit new load growth project requests throughout the year, but our forecasting process, in its current state, is very inflexible and doesn't allow easy adjustments throughout the planning year. Quite often we have to implement manual workarounds to incorporate new load growth projects or even push the evaluation until the following planning cycle because we cannot rerun the forecast process. HECO's ability to modify forecasts during the planning process is an efficient method to identify new load growth projects.
- 1.5.4  • The capacity evaluation portion of this section. The high level description of base case and contingency (N-1) evaluation seems to be very similar to SCE's. What is not clear is whether they do time-series evaluation or extract certain load points (peak, min load/max gen., etc.) from the forecasted yearly 8760 profiles to run single-point load flows. Time-series load flow is a big challenge we (SCE) are currently facing with CYME's performance issues, so it's interesting to know if this other load flow tool (Synergi by DNV-GL) is capable of better performance.
- The forecast process described in subsection 3.2 is very similar to what we do at SCE. It looks like they have system level forecasts (Company's corporate load forecasts) of various components (DER, EE, EV, etc.) that they disaggregate down to circuits by integrating geospatial factors, historian data, historical and forecast weather, and customer billing information. They also describe that historically it was done based on non-coincidental peaks and now they utilize 8760 hourly profiles for that. The rest of the details described in this section, including profile cleansing, use of representative profiles, and plans for future refinement of these representative profiles is pretty much in-line with SCE's process.
- 1.3.2  • What stood out is the statement that they "create circuit- and transformer-level forecasts". This appeared like they do very granular forecasts, down to distribution transformer level. However, reading through the rest of the document, it seems what was probably meant "transformer-level" as bank- or substation transformer-level forecast. It would be helpful to clarify. We (SCE) are currently piloting distribution transformer level forecasting process within the SAS tool, with expectation that the forecast process would be simplified and potentially allow more flexibility for continuous integration of new load growth throughout the planning cycle.

Technical editing comments

- 1.4.1 • Page 7 - Define AEG
- 1.5.7 • Page 21 - Overlaid is spelled wrong
- 1.3.2 • Figure 2 - Text is illegible
- 1.4.2 • Figure 10 – Test is illegible

Technical comments

1.4.1

- Page 7 - It would be helpful if the source of “Company’s corporate load forecasts” could be specified in a bit more detail. If it’s internal forecast that HECO develops solely by themselves, they probably have a lot of flexibility what to include (TE and BE) and magnitudes for each year to better correlate with the actual load growth project requests. The California Energy Commission’s IEPR forecast, that SCE is required to use, significantly limits our flexibility of forecast process (disaggregation and reconciliation), ability to introduce changes, such as new growth, and ability to initiate capital upgrades when customers may need them vs. when IEPR “suggests” they are needed.



1.4.2

- Page 10 - Not that you need to include it, but wondering what risk level they plan the distribution system for. Is it 1 in 10 year as showing figure 5?



1.5

- Page 11 - Mentions evaluating voltage in annual planning process but does not indicate if this is done via load flow simulation or otherwise. I think this is implied with Synergi analysis discussion later, but not clear here.



1.5.4

- Page 12 - HECO's hosting capacity analysis appears to be a blend of SCE's DER-driven Grid Reinforcement Study, and SCE's ICA, however, it is only performed for a single point in time, not time-series. This may be addressed with the use of the EPRI tool, but without mentioning that here it seems that the use of a single point in time could be limiting.



1.5.4

- Page – 13 HECO is in the process of working with EPRI to expand its hosting capacity to be time-series, probabilistic distribution of DER growth, and to consider smart inverter functions. 2020 Q2 (?) is indicated as the timeframe for enhancements discussed. I believe this is already complete and the tool is in use based on current conversations.




- Page 16 – Similar to previous comment, what is the percentage/percentile use for the threshold here?

- Page 14 - The new EPRI methodology for HC sounds like it could reflect dynamic HC in which a DPV could be curtailed upon certain system conditions, or not curtailed upon other conditions. Or mitigated by that same user later installing storage or their neighbor installing storage. But it’s not that explicit. Can this be clarified? This is a different issue than probabilistic analysis.




1.5.6

- Page 18 – OptaNode Grid2020 units mentioned, but no context of discussion is provided.

-  1.6.2 • Page 22 - I think stakeholders only care about "cost", not "complexity". They'll want you to start with cheapest solutions and work your way up. They probably don't care that much if it's complex.
-  1.6.2 • Page 22 – Similar to previous comment, more complex= more expensive might generally be true, but it does not seem very rigorous. The argument could be mad that more complex analysis, with more complex deployment, could reduce costs in the long run. This is the classic capital vs. O&M type discussion.
-  1.6.3 • Page 25 – Section 5.4 seems to just be floating with no transition or clear connection. Was it mean to be a complete list of common wires solutions?

---

## K.5. NON-WIRES OPPORTUNITY EVALUATION METHODOLOGY

This section includes the TAP Distribution Subgroup's feedback on the previously issued Non-Wires Opportunity Evaluation Methodology<sup>143</sup>, which has been revised and included in Appendix J. Feedback incorporated into this revision is denoted with this icon (with applicable section number below):  ###

Note that references to previous section numbers may not align with the revised version in Appendix J. The Company will continue to seek guidance and input as needed from the TAP to continue refining future revisions of the methodology.

### IGP TAP Distribution Subgroup

#### Feedback on Non-Wires Opportunity Evaluation Methodology

10/11/2021

**TAP members:** Kevin Schneider (PNNL, Chair), Dana Cabbell (SCE), Debra Lew (ESIG), and Aiden Tuohy (EPRI).

TAP feedback and comments are divided into three categories:

1. Informational – no action needed.
2. Suggest revising study before finalizing.
3. Consider feedback for future portions of the IGP process.

---




<sup>143</sup> See

[https://www.hawaiianelectric.com/documents/clean\\_energy\\_hawaii/integrated\\_grid\\_planning/stakeholder\\_engagement/working\\_groups/distribution\\_planning/20200602\\_dpwg\\_non\\_wires\\_opportunity\\_evaluation\\_methodology.pdf](https://www.hawaiianelectric.com/documents/clean_energy_hawaii/integrated_grid_planning/stakeholder_engagement/working_groups/distribution_planning/20200602_dpwg_non_wires_opportunity_evaluation_methodology.pdf)

High level comments.

- The Distribution Planning Methodology document was very detailed in how decisions were made. The NWA document seems to be more of a general guideline, lacking the rigor of the previous document.
- A significant comment is that the first half of this document makes the case that NWA's should include procurements, programs and prices (which is backed up by lessons learned across the country) and the second half of the document only talks about procurements. How would you compare pricing solutions to program solutions to procurement solutions? I imagine it is based on timing and cost but it's not clearly outlined. What's an example of pricing or programmatic solutions? Would you really have for example some critical peak pricing program on a specific feeder to avoid an upgrade that neighbors on another feeder would not be able to qualify for (not that there is anything wrong with that, I am just curious). I note that APS reportedly did targeted free water heaters for specific feeders so there are others doing things like this.
- Protection is only mentioned once as part of a use-case. Since this is an essential aspect of distribution systems, and will play into NWA's, it might be worth mentioning it. Especially considering the challenges that NWA can face with respect to protection, and who pays for that cost.

Technical comments

- 
 1.2.1 • Page 7 - I'd mention that HECO will explore smart inverter functionality that may provide cheaper solutions than power flow controllers, etc.
- 
 1.3.2 • Page 11 – It might be useful to tie T&D Capacity Deferral back to the capacity analysis and how this has traditionally been met with solutions in the Distribution Planning Methodology document.
- 
 1.4.2 • Page 15 - Define GO7.
- (Removed GO7) • Page 17 – Forecasting certainty. There are a number of questions here:
  - It is stated that a quantitative metric is not feasible. If that is the case, then any estimate of certainty is uncertain.
  - What is the acceptable level of uncertainty for an NWA for something such as T&D deferral? This is a fundamental question to address the viability of an NWA vs. traditional upgrade.
- Page 23 – This is the only place that protective relaying is mentioned. Considering that protection and the potential to be a recall challenge for some NWA's it should be addressed in more detail.