



**Hawaiian
Electric**

DRAFT REQUEST FOR PROPOSALS

FOR

VARIABLE RENEWABLE DISPATCHABLE GENERATION

ISLAND OF O‘AHU

FEBRUARY 2, 2018

Docket No. 2017-0352

This Request for Proposals (“RFP”) is a DRAFT only. Hawaiian Electric Company, Inc. (“Hawaiian Electric”) will employ a competitive bidding process to select renewable energy projects consistent with the State of Hawai‘i Public Utilities Commission’s (“PUC”) Competitive Bidding Framework. Under the Competitive Bidding Framework, Hawaiian Electric has filed the initial draft RFP with the PUC. Hawaiian Electric then sought input from prospective Proposers and other stakeholders through the RFP Process and the PUC as well as from the Independent Observer as described in the draft RFP and has modified the draft RFP to the extent feasible to address input received in order to foster a robust competitive process. This proposed final RFP is being submitted to the PUC for approval and is subject to further revision based upon direction received from the PUC. After approval by the PUC, Hawaiian Electric will issue the final RFP. The proposed schedule for the foregoing process is set forth in this draft RFP in Table 1.

Table of Contents

Chapter 1: Introduction and General Information	1
1.1 Authority and Purpose of the Request for Proposals	2
1.2 Scope of the RFP	3
1.3 Competitive Bidding Framework	6
1.4 Role of the Independent Observer	6
1.5 Communications Between the Company and Proposers – Procedures Manual	7
1.6 Company Contact for Proposals	8
1.7 Proposal Submittal Requirements.....	8
1.8 Proposal Fee.....	9
1.9 No Self-Build or Affiliate Options	9
1.10 Dispute Resolution Process.....	10
1.11 No Protest or Appeal.....	11
1.12 Modification or Cancellation of the Solicitation Process	11
Chapter 2: Resource Needs and Requirements.....	11
2.1 Performance Standards	11
2.2 Transmission System	12
2.3 Interconnection to the Company System	13
Chapter 3: Instructions to Proposers.....	14
3.1 Schedule for the Proposal Process	14
3.2 Company RFP Website / Electronic Procurement Platform.....	15
3.3 Technical Conference	16
3.4 Preparation of Proposals	16
3.5 Organization of the Proposal	17
3.6 Proposal Limitations	17
3.7 Proposal Compliance and Bases for Disqualification.....	18
3.8 Power Purchase Agreement	19
3.9 Pricing Formula Requirements	20
3.10 Sites Identified by the Company.....	21
3.11 Project Description.....	21
3.12 Confidentiality	23

3.13	Credit Requirements Under the PPA	23
Chapter 4: Evaluation Process and Evaluation Criteria		24
4.1	Proposal Evaluation and Selection Process	24
4.2	Eligibility Requirements	26
4.3	Threshold Requirements	26
4.4	Initial Evaluation – Price and Non-Price Analysis	28
4.5	Selection of the Short List.....	30
4.6	Best and Final Offer.....	30
4.7	Detailed Evaluation.....	31
4.8	Selection of the Final Award Group	31
Chapter 5: Post Evaluation Process		32
5.1	Interconnection Requirements Study	32
5.2	Contract Negotiation Process.....	32
5.3	Community Outreach and Engagement.....	32
5.4	PUC Approval of PPA.....	33

List of Appendices

Appendix A	Definitions
Appendix B	Proposer’s Response Package / IRS Data Sheet
Appendix C1	Model PV RDG PPA
Appendix C2	Model Wind RDG PPA
Appendix D	Code of Conduct Procedures Manual
Appendix E	PowerAdvocate User Information
Appendix F	Mutual Confidentiality and Non-Disclosure Agreement
Appendix G	Description of Available Sites
Appendix H	[RESERVED]
Appendix I	Interconnection Facilities and Cost Information
Appendix J	Rule 19 Tariff
Appendix K	[RESERVED]
Appendix L	Selection Criteria
Appendix M	Revisions to RDG PPA for Storage

List of Tables

Table 1	RFP Schedule.....	14
---------	-------------------	----

List of Figures

Figure 1	Evaluation Workflow.....	24
----------	--------------------------	----

Chapter 1: Introduction and General Information

Hawaiian Electric Company, Inc. (“Hawaiian Electric” or the “Company”) seeks proposals for the supply of qualified variable renewable dispatchable generation to be delivered to the Hawaiian Electric System in accordance with this Request for Proposals (“RFP”). The total amount of variable renewable dispatchable generation being solicited for O‘ahu is the capability to provide 485,000 megawatt hours¹ (“MWh”) annually, over a preferred term of twenty (20) years.² The resources acquired through this RFP must have Guaranteed Commercial Operations Dates that are no later than December 31, 2022 with the intent being that successful Proposers will be able to take advantage of the 2019 investment tax credit. Guaranteed Commercial Operations Date is a Threshold Requirement for this RFP. See Section 4.3 of this RFP.

The Company intends to solicit renewable dispatchable generation in stages. In the event the Company does not procure all of the variable renewable dispatchable generation needed to meet the Company’s requirements set forth in the PSIP in this first “Stage 1” of the procurement process, or if additional generation is needed as otherwise determined by the Company, then the Company intends to issue “Stage 2” of this RFP to procure such additional generation. For Stage 1 of this solicitation the Company will not be submitting a self-build and the Company will not be accepting any affiliate bids, however, the Company reserves the right to allow such options in Stage 2.

The Company intends to contract for variable renewable dispatchable generation projects under this RFP using its new Renewable Dispatchable Generation Power Purchase Agreement (“RDG PPA”), which treats variable resources as fully dispatchable. The Company has created two versions of its model RDG PPA. The photovoltaic (“PV”) version is attached as Appendix C1 to this RFP, and the wind version is attached as Appendix C2 to this RFP.³

Each successful Proposer will provide variable renewable dispatchable generation to the Company pursuant to the terms of an RDG PPA to be negotiated between the Company and

¹ The resource need for the island of O‘ahu identified in the Companies’ Power Supply Improvement Plans Update Report: December 2016 (“PSIP”) identified 180 MW of grid-scale PV and 30 MW of grid-scale wind in 2020, and an additional 40 MW of grid-scale PV in 2022. Hawaiian Electric completed a wind expression of interest (“Wind EOI”) for O‘ahu and is currently in confidential negotiations with a developer that responded to this Wind EOI, which may result in a request for waiver or waivers from the competitive bidding framework. As a result, the amount of generation set forth in the Companies’ PSIP through 2022 for O‘ahu has been reduced to remove the 30 MW of generation specified for wind. As the RFP only contains an annual energy target, the remaining megawatts were converted to MWh for this RFP. For simplicity, Hawaiian Electric has described the energy target as the capability to provide 485,000 MWh per year.

² The Company’s preferred term of 20 years reflects the assumptions and planning horizon used in the PSIP Update Report: December 2016 for the variable renewable dispatchable generation. Also, one goal of the RFP is to obtain renewable dispatchable generation at a price that will lower bills for customers. In the Company’s experience, PPAs in the 20-year range have typically provided the overall best pricing for customers while also providing adequate revenue security for renewable energy developers, which in turn should lower a developer’s cost of capital and lead to lower PPA pricing. Further, the term of a PPA may also impact accounting treatment. On this point, issues relating to accounting treatment have traditionally increased when the term of a PPA extends beyond 20 years.

³ Note that the RDG PPAs provided in Appendices C1 and C2 of this RFP have been prepared for use by Hawaiian Electric Company, Inc. Please see the Draft Requests for Proposals for Variable Renewable Generation for the Islands of Maui and Hawai‘i for adaptations of such documents for use by Maui Electric Company, Limited and Hawai‘i Electric Light Company, Inc.

Proposer, which will also be subject to PUC review and approval. If the proposed Project is for a technology other than wind or PV and/or contains an energy storage component, then the terms of the RDG PPA will be modified to address the specific technology and/or to incorporate the storage component. Revisions to the RDG PPA will be necessary to incorporate storage and would be negotiated between the Companies and the Final Award Group for a Project that includes storage. Such revisions shall include, but shall not be limited to the RDG PPA sections listed in Appendix M attached to this RFP.

The Company will evaluate Proposals using the evaluation and selection process described in Chapter 4 of this RFP. The Company will evaluate and select Proposals based on both price and non-price factors that impact the Company, its customers, and communities affected by the proposed projects. The amount of generation that the Company may acquire from this RFP depends on, among other things, the quality of bids received in response to this RFP; economic comparison to other RFP responses; updates to the Company's forecasts; transmission availability; and changes to regulatory or legal requirements.

A detailed description of the technical requirements for Proposers is included in Chapter 2 of this RFP, in the Proposer's Response Package attached as Appendix B to this RFP, in the RDG PPAs attached as Appendices C1 and C2 to this RFP, and in the Electronic Procurement Platform described in Section 3.2 of this RFP.

All requirements necessary to submit Proposal(s) are provided in this RFP. All capitalized terms used in this RFP shall have the meaning set forth in the Glossary of defined terms attached as Appendix A to this RFP. Capitalized terms that are not included in Appendix A shall have the meaning ascribed in this RFP.

1.1 Authority and Purpose of the Request for Proposals

- 1.1.1 This RFP is issued in response to Order No. 34856 issued on October 6, 2017 in Docket No. 2017-0352 as part of a procurement process established by the State of Hawai'i Public Utility Commission ("PUC").
- 1.1.2 This RFP is subject to Decision and Order ("D&O") No. 23121 in Docket No. 03-0372 (To Investigate Competitive Bidding for New Generating Capacity in Hawai'i), which sets forth the PUC's Framework for Competitive Bidding ("Framework" or "Competitive Bidding Framework").
- 1.1.3 All Proposals submitted in response to this RFP must utilize qualified Renewable Energy resource(s) as defined under the Hawai'i Renewable Portfolio Standards ("RPS").⁴ By statute, "Renewable Energy" means energy generated or produced using the following sources: (1) wind; (2) the sun; (3) falling water; (4) biogas, including landfill and sewage-based digester gas; (5) geothermal; (6) ocean water, currents, and waves, including ocean thermal energy conversion; (7) biomass, including biomass crops, agricultural and animal residues and wastes, and municipal solid waste and other solid waste; (8) biofuels; and (9) hydrogen produced from renewable energy sources. HRS § 269-91.

⁴ RPS requirements in Hawai'i are codified in Hawai'i Revised Statutes ("HRS") §§ 269-91 through 269-95.

- 1.1.4 Proposers should thoroughly review the Hawaiian Electric Companies' Power Supply Improvement Plans ("PSIPs"), filed in Docket No. 2014-0183 on December 23, 2016 ("PSIP Update Report: December 2016").
- 1.1.5 Consistent with the PSIP Update Report: December 2016, the primary purpose of this RFP is to obtain Renewable Energy so that the Company can continue to transform Oahu's power supply portfolio from fossil fuel-based generation to renewable-based generation and lower costs for customers. The Company does not have a predetermined preference for a particular renewable energy source or technology and acknowledges that the requirements of this RFP may be satisfied by a portfolio of generation resource options. The Company believes that this approach allows for flexibility and encourages Proposers to develop and submit a broad range of innovative Proposals.
- 1.1.6 This RFP is intended to elicit Proposals that will enable Hawaiian Electric to obtain variable renewable dispatchable generation at a competitive, reasonable cost with reliability, viability and operational characteristics consistent with the Company's long-term planning and energy policy requirements.

1.2 Scope of the RFP

- 1.2.1 Consistent with the resource needs for the Island of O'ahu in the Company's PSIP Update Report: December 2016, the Company is seeking Proposals for the capability to provide the supply of approximately 485,000 MWh per year ("MWh/year") of variable renewable dispatchable generation to be delivered to the Hawaiian Electric System on the Island of O'ahu in the State of Hawai'i, under contract terms to be negotiated between the Company and the Proposer in an RDG PPA.
- 1.2.2 This RFP targets Projects that can satisfy the resource needs identified in the PSIP Update Report: December 2016. In the event the Company does not procure all of the variable renewable dispatchable generation needed to meet the Company's requirements set forth in the PSIP in this first "Stage 1" of the procurement process, or if additional generation is needed as otherwise determined by the Company, then the Company intends to issue "Stage 2" of this RFP to procure such additional generation. System needs, including available hosting capacities, will be updated prior to the issuance of Stage 2 or any subsequent RFPs. The Company would consider Projects that cannot reach a Commercial Operations Date of December 31, 2022 in Stage 2 or in subsequent RFPs.
- 1.2.3 The Company is focused on helping Projects meet the 2019 investment tax credit, and is aiming to sign two PPAs on O'ahu in Stage 1 of the procurement process. The Company believes that limiting the number of Projects during Stage 1 of the procurement process will help Projects selected to the Final Award Group move through contracting and PUC approval in a more timely manner and improve the prospects of meeting the aggressive timeline required to optimize benefits to customers. The targeted number of Proposals sought in Stage 1 was determined based on the Companies' desire to meet the ITC deadlines and the Company's required Commercial Operations Date of December 31, 2022. Several factors influence the speed of the selection, contracting and development

of Projects. Projects that require extensive system upgrades to integrate into the system will take longer to complete studies for and to interconnect onto the system; therefore the Company considered in its determination of how many projects to selected factors such as, the size of the largest contingency unit and available hosting capacity⁵ on transmission-level circuits. The Company also evaluated the time it is estimated to take to expedite Projects through the contracting and Interconnection Requirements Study phases. As noted in Section 1.2.2 of this RFP, if the Company is unable to procure all of the variable renewable dispatchable generation needed to meet the Company's requirements in Stage 1, the remaining variable renewable dispatchable generation need will be sought in Stage 2 of this RFP. In Stage 2, the Companies will also use lessons learned in Stage 1 and reevaluate the storage options and requirements being sought to take advantage of advancements in technology and declining storage costs.

- 1.2.4 To avoid increasing the size of contingency events and to ensure system reliability requirements, no single point of failure from the Facility shall result in a decrease in net electrical output greater than 135MW. The current largest single contingency on the Company's system is the size of the largest generating unit on the System at any given time. The proposed renewable generation limit of not greater than 135 MW is an Eligibility Requirement for this RFP. See Section 4.2 of this RFP. The minimum size of a Facility will be the threshold for a waiver from the Competitive Bidding Framework applicable to O'ahu. See Part II.A.3.f of the Framework.
- 1.2.5 Proposals that will require system upgrades where the construction of which, in the judgment of the Company (in consultation with the IO), creates a significant risk that the Guaranteed Commercial Operations Date will not be met or the Project will not be able to capture the ITC, will not be considered in this RFP. Guaranteed Commercial Operations Date is a Threshold Requirement for this RFP. See Section 4.3 of this RFP.
- 1.2.6 Proposers will determine their Project Site. Proposers have the option of engaging with landowners and submitting a Proposal for any potential Site that may be offered as described in Section 3.10 of this RFP.
- 1.2.7 For purposes of this RFP, the Company will only consider Proposals for Projects located on the Island of O'ahu. This is an Eligibility Requirement for this RFP. See Section 4.2 of this RFP.
- 1.2.8 Each Proposal submitted in response to this RFP must represent a Project that is capable of meeting the requirements of this RFP without having to rely on the completion or implementation of any other Project submitted in response to this RFP or any other RFP.

⁵ For context, each transmission-level circuit (46 kV and 138 kV on O'ahu) has a certain amount of "hosting capacity." This is the amount of power a conductor can safely carry within engineering limits. For the purposes of this RFP, the hosting capacity is expressed in megawatts ("MW"). The available hosting capacity on a given transmission-level circuit is the difference between the total hosting capacity and the amount of peak power already carried on a transmission circuit.

- 1.2.9 Successful Proposers will own and be responsible for the operation of the Facility during the term of the PPA and will be responsible for all costs, including Project development, completion of an Interconnection Requirement Study (“IRS”), land acquisition,⁶ permitting, financing, construction of the facility and all Interconnection Facilities, and operations and maintenance.
- 1.2.10 PPAs for projects selected through this RFP will be based on the RDG PPA, as described in Section 3.8 of this RFP. Under the RDG PPA, the Company will maintain exclusive rights to fully direct the dispatch of the Facility.
- 1.2.11 The preferred Term of the PPA will be twenty (20) years.
- 1.2.12 Proposals may be submitted in either of the following configurations:
- **Not coupled with energy storage:** Where a proposed Facility is not coupled with energy storage, the maximum output of the Facility must not exceed the transmission-level available hosting capacity of the transmission-level circuit to which the Facility will be interconnected.⁷ Available Transmission Circuit Capacity is a Threshold Requirement for this RFP. See Section 4.3 of this RFP.
 - **Coupled with energy storage:** Proposals may contain storage which may be charged during periods when full potential export is not being taken by the Company, and used to provide energy to the Company during periods when source energy is not available. While the Company maintains complete charging rights (limited to the periods during which the generator is generating) and dispatch rights over the entire Facility and may charge and dispatch the Facility at any time, the energy storage should be sized at a minimum to provide sufficient storage capacity equal to the greatest amount of projected energy during the Facility’s projected most productive continuous four hours at any period during the year and designed to provide one full discharge for every 24 hours. The Company will reserve the right to dispatch net energy available from the Facility, reflecting the combined available renewable and storage available capacity, at times that are beneficial to the system and for customers under the terms of the PPA. Flexibility in charging/discharging periods is necessary due to uncertainty in future demand profiles over the life of the contract. The proposed storage must be charged solely by the Facility and grid charging will not be allowed.

Proposers are encouraged to confer with the Company as described in Section 2.2.1 of this RFP should they have any questions about transmission-level or system-level available hosting capacity or excess energy concerns.

- 1.2.13 Consistent with the assumptions in the PSIP Update Report: December 2016, Proposers shall pursue all available applicable federal and state tax credits, and Proposal pricing

⁶ See Section 3.10 regarding results of the Land RFI.

⁷ Proposers are advised that transmission circuit loadings may change in the future. This will reduce the available transmission-level hosting capacity.

must be set to incorporate the benefit of such tax credits or to pass the benefit of the tax credits to the Company's customers. See Attachment J, Section 5 of the RDG PPA, attached as Appendix C1 and Appendix C2 to this RFP.

- 1.2.14 Payments under the RDG PPA will be made by the Company to the Seller as described in the RDG PPA, attached as Appendix C1 and Appendix C2 to this RFP.
- 1.2.15 The Project will interconnect to the Company's grid at the 46 kV or 138 kV level. Interconnection Requirements and the IRS process are described in Section 2.3 and Section 5.1 of this RFP.
- 1.2.16 A Proposer's proposed Interconnection Facilities shall be compatible with the Company System and must meet the requirements set forth in the IRS and the PPA, as may be revised to reflect the results of the IRS. Proposer shall take responsibility for all costs related to the design and installation of all Interconnection Facilities. The communications and control requirements will be determined during the Interconnection Requirements review and will define telemetry, control, and communications facilities provided by the Proposer to the Point of Interconnection. Alternate control will be required.
- 1.2.17 Storage systems that are coupled with a Facility must be charged only by Renewable Energy generated by the Facility (and not delivered from the grid). This is an Eligibility Requirement for this RFP. See Section 4.2 of this RFP.
- 1.2.18 Supplemental equipment to generating resources such as power electronics and storage systems may be utilized by the Seller, at the Seller's discretion, to meet the Performance Standards for energy delivery specified in the RDG PPA, in addition to consideration of storage to supply Dispatchable energy during periods where the source Renewable Energy from the Facility is not available as described in Section 1.2.12. Where supplemental equipment and/or storage are utilized, the functionality and characteristics of the storage must be maintained throughout the term of the PPA.
- 1.2.19 If selected, Proposers shall take responsibility for the decommissioning of the Project and the restoration of the Site upon the expiration of the PPA, as described in Attachment G, Section 7 of the RDG PPA.

1.3 Competitive Bidding Framework

Consistent with the Framework, this RFP outlines the Company's requirements in relation to the resources being solicited and the procedures for conducting the RFP process. It also includes information and instructions to prospective Proposers participating in and responding to this RFP.

1.4 Role of the Independent Observer

- 1.4.1 Part III.C.1 of the Framework sets forth the circumstances under which an Independent Observer is required in a competitive bidding process. The PUC has retained an Independent Observer both to advise and monitor the process for this RFP. All phases of

the RFP process will be subject to the Independent Observer's oversight, and the Independent Observer will coordinate with PUC staff throughout the RFP process to ensure that it is undertaken in a fair and unbiased manner. In particular, the Company will review and discuss with the Independent Observer all decisions regarding the evaluation, disqualification, non-selection, and selection of Proposals prior to notifying Proposers of such decisions.

1.4.2 The role of the Independent Observer, as described in the Framework, will include but is not limited to:

- Monitor all steps in the competitive bidding process
- Monitor communications (and communications protocols) with Proposers
- Monitor adherence to the Company's Code of Conduct
- Submit comments and recommendations, if any, to the PUC concerning the RFP
- Review the utility's Proposal evaluation methodology, models, criteria, and assumptions
- Review the utility's evaluation of Proposals
- Advise the utility on its decision-making
- Participate in dispute resolution as set forth in Section 1.10 of this RFP
- Monitor contract negotiations with Proposers
- Report to the PUC on monitoring results during each stage of the competitive bidding process
- Provide an overall assessment of whether the goals of the RFP were achieved

1.4.3 The Independent Observer for this RFP is **Bates White, LLC**.

1.5 Communications Between the Company and Proposers – Procedures Manual

1.5.1 Communications and other procedures under this RFP are governed by the "Procedures Manual," developed by the Company as required by the Framework, which describes: (1) the protocols for communicating with prospective Proposers and others; (2) the evaluation process in detail and the methodologies for undertaking the evaluation process; (3) the documentation forms, including logs for any communications with bidders; and (4) other information consistent with the requirements of the RFP process. The Company's Code of Conduct Procedures Manual is attached as Appendix D to this RFP.

1.5.2 Pursuant to the Procedures Manual, all pre-Proposal communication with prospective Proposers will be conducted via the Company's website, Electronic Procurement Platform and/or electronic mail ("Email") as specified in the Procedures Manual. Any Email to the Company must be sent to the address specified in Section 1.6 of this RFP (the "RFP Email Address"). Any correspondence sent to any other Email address will not receive a response. Frequently asked questions submitted by prospective Proposers and the answers to those questions may be posted on the Company website or sent through the Electronic Procurement Platform to registered individuals. The Company

reserves the right to respond only to comments and questions it deems are appropriate and relevant to the RFP.

- 1.5.3 After submission of Proposals, all contacts between the Company and Proposers will be coordinated by the Energy Contract Manager identified in Section 1.6 of this RFP. During this post-Proposal submission period, the Company may have communications and meetings with individual Proposers for purposes of clarifying Proposals.
- 1.5.4 Each Proposer must execute a Mutual Confidentiality and Non-Disclosure Agreement (“NDA”) attached as Appendix F to this RFP. The full execution of agreements or other documents required is an Eligibility Requirement for this RFP. See Section 4.2 of this RFP. All confidential information will be transmitted to the requesting party via the RFP email address and/or the Electronic Procurement Platform only after receipt of such fully executed NDA. Notwithstanding the execution of a NDA by a requesting party, the Company reserves the right, in its sole discretion, not to disclose certain confidential information.
- 1.5.5 Except as expressly permitted and in the manner prescribed in the Procedures Manual, any unsolicited contact by a Proposer or prospective Proposer with personnel of the Company pertaining to this RFP is prohibited.

1.6 Company Contact for Proposals

The Energy Contract Manager and primary contact for this RFP is:

Ken Horita
Energy Contract Manager
Hawaiian Electric Company, Inc.
Central Pacific Plaza Building, Suite 2100
220 South King Street
Honolulu, Hawai‘i 96813

RFP Email Address: oahuvariablerfp@hawaiianelectric.com

1.7 Proposal Submittal Requirements

- 1.7.1 Detailed requirements regarding the form and organization of the Proposal are set forth in Chapter 3 of this RFP. Proposals must be submitted in the format specified in the Electronic Procurement Platform and must include all of the information in the Proposer’s Response Package attached as Appendix B to this RFP.
- 1.7.2 In submitting a Proposal in response to this RFP, each Proposer certifies that the Proposal has been submitted in good faith and without fraud or collusion with any other person or entity. The Proposer shall complete and submit with each Proposal, a Certificate of Non-Collusion in the form provided on the Electronic Procurement Platform. Signature and certification are Eligibility Requirements for this RFP. See Section 4.2 of this RFP.

- 1.7.3 Proposals must be submitted via the Electronic Procurement Platform by 2:00 pm Hawai'i Standard Time (HST) on the date shown in the RFP Schedule in Section 3.1, Item 10 of this RFP. Incomplete Proposals will not be accepted. No hard copies of the Proposals will be accepted.

1.8 Proposal Fee

- 1.8.1 Proposers are required to tender a non-refundable Proposal Fee of \$10,000 for each Proposal submitted. The Proposal Fee submission deadline is an Eligibility Requirement for this RFP. See Section 4.2 of this RFP.
- 1.8.2 Proposers may submit multiple Proposals for projects. If such Proposals are on different Sites or for different generation technologies, a separate Proposal Fee must be paid for each Proposal, except that a Proposer may submit a Proposal for a Project with and without a storage option for a Project on the same Site for a single Proposal Fee, as described in Section 1.2.12 of this RFP. Proposers may submit up to three (3) Proposals with minor variations (i.e., pricing terms, size) (for with and without storage) on the same Site using the same generation technology without having to pay a separate Proposal Fee for these three (3) variations.⁸ The method of submitting multiple Proposals within this RFP is described in Section 3.2 and Appendix E. Whether or not a separate Proposal Fee is required each variation of a Proposal, no matter how minor such variation is, should be submitted separately through Power Advocate, including separate entries for a proposal with storage and without.
- 1.8.3 The Proposal Fee must be in the form of a cashier's check made payable to Hawaiian Electric Company, Inc. and must be delivered and received by the Company's Energy Contract Manager by 2:00 pm (HST) on the date shown in the RFP Schedule in Section 3.1, Item 10 of this RFP. Proposers are strongly encouraged to utilize a delivery service method that provides proof of delivery to validate delivery date and time.

If the Proposal Fee is to be delivered by U.S. Postal Service (with registered, certified, receipt verification), the Proposer shall use:

Ken Horita
Energy Contract Manager
Hawaiian Electric Company, Inc.
Mail Code CP21-IU
PO Box 2750
Honolulu, HI 96840

If the Proposal Fee is to be delivered in person, or via an alternative registered, certified delivery service, the Proposer shall use the address specified in Section 1.6.

⁸ To the extent that Proposers submit Proposals with and without storage, a total of up to (6) six variations may be submitted for a single Proposal Fee, 3 for the with storage Proposal and 3 for the without storage Proposal.

1.9 No Self-Build or Affiliate Options

The Competitive Bidding Framework allows the Company the option to offer a Proposal in response to this RFP (“Self-Build Option”). The Company will NOT be providing a Self-Build Option in response to this Stage 1 of the RFP but reserves the right to do so in Stage 2 or in future solicitations. Therefore, the Company will follow certain procedures designed to safeguard against and address concerns associated with preferential treatment or preferential access to information to agents of the Company who may participate in the development of a future Self-Build Option (the “Self-Build Team”). The procedures of the Company’s Code of Conduct and the Procedures Manual submitted to the PUC in Docket No. 2017-0352 on October 23, 2017 are in place to safeguard against and address concerns associated with preferential treatment or preferential access to information. A copy of the Procedures Manual is attached as Appendix D to this RFP.

The Competitive Bidding Framework also allows affiliates of the Company to submit Proposals to RFPs issued by the Company. However, for this Stage 1 of the RFP, the Company will not accept any Proposals from affiliates but reserves the right to do so in Stage 2 or in future solicitations.

1.10 Dispute Resolution Process

- 1.10.1 If disputes arise under the RFP, the provisions of Section 1.10 of this RFP and the dispute resolution process established in the Framework will control. See Part V of the Framework.
- 1.10.2 Proposers who challenge or contest any aspect of the RFP process must first attempt to resolve their concerns with the Company and the Independent Observer (“Initial Meeting”). The Independent Observer will seek to work cooperatively with the parties to resolve any disputes or pending issues and may offer to mediate the Initial Meeting to resolve disputes prior to such issues coming before the PUC.
- 1.10.3 Any and all disputes arising out of or relating to the RFP which remain unresolved for a period of twenty (20) days after the Initial Meeting takes place may, upon the agreement of the Proposer and the Company, be submitted to confidential mediation in Honolulu, Hawai‘i, pursuant to and in accordance with the Mediation Rules, Procedures, and Protocols of Dispute Prevention Resolution, Inc. (“DPR”) (or its successor) or, in its absence, the American Arbitration Association then in effect (“Mediation”). The Mediation will be administered by DPR. If the parties agree to submit the dispute to Mediation, the Proposer and the Company shall each pay fifty percent (50%) of the cost of the Mediation (i.e., the fees and expenses charged by the mediator and DPR) and shall otherwise each bear their own Mediation costs and attorney’s fees.
- 1.10.4 If settlement of the dispute is not reached within sixty (60) days after commencement of the Mediation, or if after the Initial Meeting, the parties do not agree to submit any unresolved disputes to Mediation, then as provided in the Framework, the Proposer may seek a determination of the issue by the PUC.

- 1.10.5 In accordance with the Framework, the PUC will serve as the arbiter of last resort for any disputes relating to this RFP involving Proposers. The PUC will use an informal expedited dispute resolution process to resolve the issue within thirty (30) days, as described in Parts III.B.8 and V of the Framework.⁹ There will be no right to hearing or appeal from this informal expedited dispute resolution process.
- 1.10.6 If any Proposer initiates a dispute resolution process for any dispute or claim arising under or relating to this RFP, other than that permitted by the Framework and Section 1.10 of this RFP (e.g. arbitration or court proceeding), then such Proposer shall be responsible for any and all attorney's fees and costs that may be incurred by the Company or the PUC in order to resolve such claim.

1.11 No Protest or Appeal

Subject to Section 1.10 of this RFP, no Proposer or other person will have the right to protest or appeal any award of a Project made by the Company.

1.12 Modification or Cancellation of the Solicitation Process

- 1.12.1 Unless otherwise expressly prohibited, the Company may, at any time up to the final award, in consultation with the Independent Observer, postpone, withdraw and/or cancel any requirement, term or condition of this RFP, including deferral of the award of any contract, and/or cancellation of the award all together, all of which will be without any liability to the Company.
- 1.12.2 The Company may modify this RFP subject to requirements of the Framework, whereby the modified RFP will be reviewed by the Independent Observer and submitted to the PUC thirty (30) Days prior to its issuance, unless the PUC directs otherwise. See Framework Part IV.B.10. The Company will follow the same procedure with regard to any potential postponement, withdrawal or cancellation of the RFP or any portion thereof.

Chapter 2: Resource Needs and Requirements

2.1 Performance Standards

Proposals must meet the attributes set forth in this RFP and the Performance Standards identified in the RDG PPA. This RFP and the RDG PPA set forth the minimum requirements that all Proposals must satisfy to be eligible for consideration in this RFP. Attributes and Performance Standards are Threshold Requirements for this RFP. See

⁹ The informal expedited dispute resolution process does not apply to PUC review of contracts that result from the RFP. See Decision and Order No. 23121 at 34-35. Further, the informal expedited dispute resolution process does not apply to the Framework's process relating to issuance of a draft and final RFP, and/or to the PUC approval of the RFP because: (1) the Framework (and the RFP) set forth specific processes whereby interested parties may provide input through the submission of comments; and (2) the Framework's dispute resolution process applies to "Bidders" and there are no "Bidders" at this stage in the RFP process.

Section 4.3 of this RFP. Additional Performance Standards may be required based on the results of the IRS.

2.2 Transmission System

2.2.1 Company information regarding an initial assessment of potential MW capacity of 46 kV and 138 kV transmission circuits providing possible points of interconnection has been developed for Sites included in the Land RFI as described in Section 3.10 of this RFP and will be made available to Proposers only after execution of a Non-Disclosure Agreement. Non-confidential information has been published in the Companies' December 23, 2016 PSIP Update Report beginning on page N-56 of Appendix N. Proposers should perform their own evaluation of project locations, and the Company does not guarantee any project output or ability to connect based on such information. Proposers are strongly encouraged to meet with the Company prior to submitting a Proposal to discuss specific questions regarding a particular Proposal. Please direct inquiries to Interconnection Services at Interconnection.services@hawaiianelectric.com.

2.2.1.1 The objective of the analysis was to determine the available capacity of the transmission lines that are in close proximity to the Land RFI parcels. Load flow analyses were performed by adding a generating unit at select locations and increasing its MW output until the thermal limit of the transmission system was met. Existing transmission system infrastructure and distributed generation resources were assumed. Individual load flow simulations did not take into account potential impacts of additional generating projects added to the transmission system.

For Oahu, the RFP assumes new generators connecting to existing substations at the transmission level. Load flow analyses were performed by adding a generating unit at select transmission substations near Land RFI parcels and increasing its MW output until the maximum transfer capability of the transmission system is reached (under N-1-1 contingency).

In addition for Oahu, the Hawaiian Electric Sub-Transmission Electrical System was analyzed to determine the largest generator that can be placed onto the Sub-Transmission Electrical System. Each Transmission Substation Transformer (138/46kV) and its normally connected Sub-Transmission Circuits were analyzed together. Models of each Sub-Transmission Circuit are modeled as a consolidation of multiple sections of conductor or cable that represent the entire circuit.

For each Section on the Sub-Transmission Circuits, a load flow analysis was conducted to monitor the voltage and ampacity by placing a generator on the section of interest. Only one generator is placed on the circuit for each simulation, and the generator's size was increased until a voltage or ampacity issue was witnessed. The result produced the amount of Generation that can be placed on one section or at one interconnection point.

2.2.2 Prior to the RFP, developers may inquire as to viability of proposed real Project locations. Hypothetical Projects and location strategies will be addressed only in general terms.

2.2.3 Additional site-specific information will be provided in the IRS process.

2.3 Interconnection to the Company System

2.3.1 The means of interconnection between a proposed Facility and the Company System is a critical consideration for all Proposers. All Proposals should include a description of the respondent's plan to transmit power from the Facility to the Company System. The Proposers' proposed Interconnection Facilities must be compatible with the Company System. In the design, Projects must adequately consider Company requirements to address impacts on the performance and reliability of the Company System. In addition to the Performance Standards and findings of the Interconnection Study, the design of the Interconnection Facilities, including power rating, Point(s) of Interconnection with the Company System, and scheme of interconnection, must meet Company standards and be designed such that, with the addition of the Facility, the Company system can meet all relevant Transmission Planning Criteria¹⁰ and any amendments thereto. The Company will provide its construction standards and procedures to the Proposer if requested via email upon the execution of an NDA as specified in Section 1.6.

2.3.2 The Interconnection Facilities includes both: (1) Seller-Owned Interconnection Facilities; and (2) Company-Owned Interconnection Facilities.

2.3.3 Tariff Rule No. 19, a copy of which is attached as Appendix J to this RFP, establishes provisions for Interconnection and Transmission Upgrades. The tariff provisions are intended to simplify the rules regarding who pays for, installs, owns, and operates interconnection facilities in the context of competitive bidding. Proposers may propose to build the Company-Owned Interconnection Facilities except for any work to be done in the Company's existing facilities. Construction of Company-Owned Interconnection Facilities by the Proposer must comply with industry standards, laws, and license information, as well as the Company's specific construction standards and procedures that the Company will provide upon request. (See Section 2.3.1.) The Company uses the breaker-and-a-half scheme for its transmission switching station as shown in Attachment A of Tariff Rule No. 19. Proposers should follow this scheme for purposes of their estimates.

2.3.4 The Proposer shall be responsible for all costs required to interconnect a Project to the Company System, including all Seller-Owned Interconnection Facilities and Company-Owned Interconnection Facilities.

2.3.5 Proposers are required to include in their pricing proposal all costs for interconnection and transmission upgrades or distribution upgrades expected to be required between their

¹⁰ Transmission Planning Criteria are further described in the Companies' December 23, 2016 PSIP Update Report beginning on page O-11 of Appendix O.

Facility and their proposed Point of Interconnection. See Appendix I to this RFP. Selected Proposers will be responsible for the actual final costs of all Seller-Owned Interconnection Facilities and Company-Owned Interconnection Facilities, whether or not such costs exceed the costs set forth in a Proposer's Proposal. No adjustments will be allowed to the offered price in a Proposal if actual costs for Interconnection Facilities exceed the amounts Proposed.

- 2.3.6 All Projects will be screened for general readiness to comply with the requirements for interconnection. Proposals selected to the Final Award Group will be subject to further study in the form of an Interconnection Requirements Study. The IRS process is further described in Section 5.1 of this RFP. The IRS will provide information on including, but not limited to, a power systems analysis and identification of equipment, costs, and schedule to evaluate the upgrades necessary to interconnect the proposed Project into the Company System, individually or on a portfolio basis. The results of the completed IRS, as well as any mitigation measures identified, will be incorporated into the terms and conditions of a final executed PPA. The Proposer must provide all Proposal information required to complete the IRS with the Proposal, as described in Appendix B to this RFP. Any additional information required must be provided no later than fifteen (15) days after request by the Company.

Chapter 3: Instructions to Proposers

3.1 Schedule for the Proposal Process

Table 1 sets forth the schedule for the proposal process (the "RFP Schedule"). This schedule is designed to provide Proposers the opportunity to safe harbor tax credits. The Company reserves the right to revise the RFP Schedule as necessary. Changes to the RFP Schedule will be posted to the RFP website.

**Table 1
RFP Schedule**

Milestone	Schedule Dates
(1) PUC Opens RFP Docket	October 6, 2017
(2) Draft RFP is filed	October 23, 2017
(3) Technical Conference Webinar	November 3, 2017
(4) Stakeholder Comments submitted to PUC	November 13, 2017
(5) Companies' Response to Stakeholder Comments filed	December 20, 2017
(6) PUC Order Providing Guidance	January 12, 2018
(7) Proposed Final RFPs filed	February 2, 2018
(8) Completion of Commission review period of Proposed Final RFPs	No later than February 19, 2018
(9) Final RFP is issued	5 business days after (8) ¹¹
(10) Proposals due	60 days after (9) at 2:00 pm HST
(11) Selection of Short List	30 days after (10)
(12) BAFOs due	5 business days after (11)
(13) Selection of Final Award Group ¹²	105 days after (12)
(14) Contract Negotiations Start	2 business days after (13)

3.2 Company RFP Website/Electronic Procurement Platform

3.2.1 The Company has established a website for general information to share with potential Proposers. The website is located at the following link:

www.hawaiianelectric.com/competitivebidding

The Company will provide general notices, updates, schedules and other information on the RFP website throughout the process. Proposers should check the website frequently to stay abreast of any new developments. This website will also contain the link to the Electronic Procurement Platform employed by the Company for the receipt of Proposals. The Company will send updates posted on the website through the Electronic Procurement Platform.

“Sourcing Intelligence” developed by Power Advocate is the Electronic Procurement Platform that the Company has licensed and will utilize for this RFP. Proposers who do not already have an existing account with PowerAdvocate and who intend to submit a Proposal for this RFP will need to register as a “Supplier” with PowerAdvocate.

¹¹ Subsequent dates are dependent on the procedural schedule set by the PUC.

¹² If the quantity and complexities of the Proposals allow for a quicker evaluation period, the Final Award Group will be announced sooner to allow more time for subsequent steps.

- 3.2.2 There are no license fees, costs, or usage fees to Proposers for the use of the PowerAdvocate Platform.

See Appendix E to this RFP for registration, user information and instructions on PowerAdvocate's Sourcing Intelligence procurement platform.

- 3.2.3 Proposals will be accepted only through the PowerAdvocate Platform.

- 3.2.4 Proposals must be submitted through Sourcing Intelligence by 2:00 pm Hawai'i Standard Time (HST) on the date shown in the RFP Schedule in Section 3.1, Item 10 of this RFP. Sourcing Intelligence will not accept the submittal of late information for this RFX event. The Proposal submission deadline via the PowerAdvocate Platform is an Eligibility Requirement for this RFP. See Section 4.2 of this RFP.

- 3.2.5 All Proposals must be prepared in accordance with the procedures and format specified in the RFP and the RFX event. Proposers also are required to respond to all questions and provide all information requested in the RFP and the RFX event, as applicable. This process is intended to provide an orderly, consistent and fair evaluation of the Proposals.

3.3 Technical Conference

The Company held a webinar ("Technical Conference Webinar") in accordance with the Competitive Bidding Framework for prospective Proposers and other stakeholders to discuss the provisions and requirements of this and other RFPs being offered in parallel. The Technical Conference Webinar allowed stakeholders to submit questions and was intended to help them better understand the Companies' proposed competitive bidding process and draft documents.

This Technical Conference Webinar was held on November 3, 2017. An electronic version of the Technical Conference Webinar is available on demand via the RFP website listed in Section 3.2.1. Prospective Proposers may submit written questions regarding the RFP to the RFP Email Address set forth in Section 1.6. The Company will endeavor to address all questions that will be helpful to prospective Proposers via a Q&A section on the RFP website. Once the PowerAdvocate RFX event has been opened and the RFP is open for bid submissions, Proposer questions should be directed through PowerAdvocate's messaging feature.

The Company also prepared a webinar to introduce the concepts and provisions of the new RDG PPA ("RDG PPA Webinar"). The Company encourages any party interested in submitting a Proposal to view the RDG PPA Webinar as well. This RDG PPA Webinar is available on-demand on the Company website listed in Section 3.2.1 of this RFP. Parties interested in submitting questions regarding the RDG PPA Webinar may send them to the email address set forth in Section 1.6 of this RFP.

3.4 Preparation of Proposals

- 3.4.1 Each Proposer shall be solely responsible for reviewing the RFP (including all attachments and links) and for thoroughly investigating and informing itself with respect

to all matters pertinent to this RFP, the Proposer's Proposal, and Proposer's anticipated performance under the PPA.

- 3.4.2 Proposers shall rely only on official information provided by the Company in this RFP when preparing their Proposal. The Company will rely only on the information included in the Proposals and additional information from Proposers solicited by the Company to evaluate the Proposals received.
- 3.4.3 Each Proposer shall be solely responsible for and shall bear all of its costs incurred in the preparation of its Proposal and/or its participation in this RFP, including, but not limited to, all costs incurred with respect to the following: (1) review of the RFP documents; (2) meetings with the Company; (3) Site visits; (4) third-party consultant consultation; and (5) investigation and research relating to its Proposal and this RFP. Any such costs associated with the same will not be reimbursed by the Company to any Proposer, including the selected Proposer(s).
- 3.4.4 Each Proposal must contain the full name and business address of the Proposer and must be signed by an authorized officer or agent¹³ of the Proposer. Signature and certification are Eligibility Requirements for this RFP. See Section 4.2 of this RFP.

3.5 Organization of the Proposal

Appendix E to this RFP provides information for submitting Proposal information through the PowerAdvocate Platform.

Each Proposer shall agree to the use of electronic signature within the PowerAdvocate Platform or on other appropriate certification forms for the Proposal.

3.6 Proposal Limitations

Proposers expressly acknowledge that Proposals are submitted subject to the following limitations:

The RFP does not commit or require the Company to award a contract, pay any costs incurred by a Proposer in the preparation of a Proposal, or procure or contract for products or services of any kind whatsoever. The Company reserves the right, in consultation with the Independent Observer, to accept or reject, in whole or in part, any or all Proposals submitted in response to this RFP, to negotiate with any or all Proposers eligible to be selected for award, or to withdraw or modify this RFP in whole or in part at any time.

- The Company reserves the right, in consultation with the Independent Observer, to request additional information from any or all Proposers relating to their Proposals

¹³ Proposer's officer or agent must be authorized to sign the Proposal. Such authorization must be in writing and may be granted via Proposer's organizational documents (i.e., Articles of Incorporation, Articles of Organization, By-laws, etc.), resolution, or similar documentation.

or to request that Proposers clarify the contents of their Proposals. Proposers who are not responsive to such information requests may be eliminated from further consideration upon consultation with the Independent Observer.

- The Company reserves the right, in consultation with the Independent Observer, to solicit additional Proposals from Proposers after reviewing the initial Proposals. Other than as provided in this RFP, no Proposer will be allowed to alter its Proposal or add new information to a Proposal after the due date for submission of Proposals.
- All material submitted in response to this RFP will become the sole property of the Company, subject to the terms of the NDA.

3.7 Proposal Compliance and Bases for Disqualification

Proposers may be deemed non-responsive and/or Proposals may not be considered for reasons including, but not limited to, the following:

- Any unsolicited contact by a Proposer or prospective Proposer with personnel of the Company pertaining to this RFP as described in Section 1.5.5.
- The Proposal does not meet one or more of the Eligibility Requirements specified in Section 4.2.
- The Proposal does not meet one or more of the Threshold Requirements specified in Section 4.3.
- The Proposal is deemed to be unacceptable through a fatal flaws analysis as described in Section 4.4.2.
- The Proposer does not respond to the Company's request for additional information to clarify the contents of its Proposal.

3.8 Power Purchase Agreement

- 3.8.1 The Power Purchase Agreement for Proposers selected under this RFP will be in the form of the Company's RDG PPA¹⁴, attached as Appendix C1 and Appendix C2 to this RFP.
- 3.8.2 In general, under the RDG PPA, payment to the Seller contains two parts: a Lump Sum Payment component to cover the fixed costs of the Project and an Energy Payment (\$/MWh component) to cover variable operations and maintenance costs (if applicable, depending on the resource). In return, the Seller shall guarantee minimum availability metrics to ensure that the Facility is maintained and available for production, as well as provide an indication of the available energy available in near real-time for the Company's dispatch.
- 3.8.3 Proposers may propose modifications to the RDG PPA but are encouraged to accept the RDG PPA in order to expedite the overall RFP process and potential PPA negotiations. As a component of their Proposals, Proposers who elect to propose modifications shall provide a red-line version of the RDG PPA identifying their requested modifications as well as a detailed explanation and supporting rationale for each modification. Such modifications will be evaluated as a non-price evaluation criteria as further described in Section 4.4 and Appendix L. In order to facilitate this process, the Company will make available electronic versions of the RDG PPA. Any proposed modifications to the RDG PPA will be subject to negotiation between the Company and the Final Award Group. Certain provisions of the RDG PPA, such as the calculation of availability and payment terms, may be administratively burdensome to endeavor if they differ between selected Projects. Therefore, the Company will endeavor to negotiate similar provisions across the Final Award Group for such provisions.

¹⁴ As directed by the PUC in the Kuia Solar (2015-0224) and South Maui Renewable Resources (2015-0225) dockets, the Company has been exploring alternative contract structures that better address the growing issue of curtailment of excess energy as the Company progresses towards 100% renewable energy. Additionally, as generation resources continue to shift from primarily centralized, utility-owned facilities to more distributed facilities owned by independent power producers, greater operational flexibility is required to ensure the safe, reliable, and cost effective operation of the grid. As described in the whitepaper prepared for the Companies in December 2016 by the Smart Electric Power Association Alliance ("SEPA") and ScottMadden Inc. filed in Dockets 2015-0224 and 2015-0225, "as the islands evolve to ever-increasing levels of renewable energy, the ability to treat any type of energy as 'must-take' [as under the RAP or As-Available PPA models] is increasingly limited." Moreover, such "must-take" models "fail to allocate curtailment risk in a way that is equitable to all parties, transparent to all stakeholders, and sustainable in the future with increasing need to control energy production to match demand." Consistent with meeting the future needs of the grid, the expectation is that all generation resources, whether utility, IPP or customer owned, will contribute to maintaining system stability. As a result, the Company is looking to move away from the traditional, intermittent renewable energy model of payments for energy and is seeking to select Projects based on the RDG PPA where payments are instead based on a Facility's availability and performance for a measured level of available solar or wind resource. This eliminates the revenue uncertainty associated with curtailment for IPPs while also providing the Company's system operators with the ability to dispatch resources as required to meet load and to address reliability needs through their use as ancillary services. The proposal evaluation methods and contract provisions for this approach are further described in Appendices L and C1 and C2, respectively, to this RFP.

3.8.4 Proposals that do not include proposed revisions to the attached RDG PPA will be deemed to have accepted the RDG PPA terms.

3.9 Pricing Formula Requirements

3.9.1 Proposers may submit pricing for one or both options, as described in Section 1.2.12 of this RFP. Please also refer to Section 1.8:

- Proposal without a storage component
- Proposal with a storage component

3.9.2 Proposer's Response Package must include the following prices for each option:

- **Lump Sum Payment (\$/year):** Payment amount for full availability. Payment will be made in monthly increments. No escalation of the Lump Sum Payment over time will be allowed. A Proposal's Lump Sum Payment will be compared to other Proposals on a \$/MWh basis based on the NEP RFP Projection, which is the annual estimated Net Energy Production (MWh) of the Facility for the term of the PPA as described further in Section 3.11.2 of this RFP.
- Estimated Total Interconnection Costs (See Appendix I to this RFP): Proposers are required to include in their pricing proposal all costs for interconnection and transmission upgrades or distribution upgrades expected to be required between their Facility and their proposed Point of Interconnection. (See Attachment A to Tariff Rule No. 19.)
- **Energy Payment Price (\$/MWh):** Payment for delivery of Net Energy.
- **Interconnection Costs Savings Rate (\$/year):** Amount per \$100,000 (lower than the estimate) of actual interconnection costs.
- The intent of the Interconnection Costs Savings Rate is to include a shared savings mechanism between Projects selected in the Final Award Group and the Company's customers. Proposers should include a downward adjustment to their Lump Sum Payment for every \$100,000 in savings Proposers achieve based on their actual interconnection costs as compared to the proposed interconnection costs set forth in their Proposal. The Lump Sum Payment will automatically be reduced by the Interconnection Cost Savings Rate in increments if a Proposer in the Final Award Group achieves at least \$100,000 in savings between its proposed Estimated Total Interconnection Costs and its actual total interconnection costs. Savings will be rounded to the nearest \$100,000. The Final Award Group will be required to submit evidence of their actual total Interconnection Costs (i.e. invoices, purchase orders) to the Company upon the Commercial Operations Date. For Example: Assume a selected Proposal includes a Lump Sum payment of \$5,000,000/year and an Interconnection Costs Savings Rate of \$2,000/year per \$100,000 and the Total Estimated Interconnection Costs

set forth in the Proposal are \$1,000,000. Further assume that the evidence submitted by the selected Proposer reflected actual total interconnection costs of \$725,000. The actual interconnection costs would be rounded to \$700,000 and there would be a savings to the developer of \$275,000 in Interconnection Costs. Rounding the savings to nearest \$100,000 brings us to \$300,000, so the Interconnection Costs Savings rate would be multiplied by 3. In such case the Lump Sum Payment due the selected Proposer would be reduced by \$6,000 (3 x \$2,000) to \$4,994,000/year. The savings realized by the Company's customers and the selected Proposer would be as follows:

- Customers = \$120,000 (\$6,000 x 20 years) in savings
- Selected Proposer = \$155,000 (\$275,000-\$120,000) in savings

3.9.3 All Proposal information must be independent of changes to state or federal investment tax credit policies. The requirement that Proposals must not be contingent upon changes to laws or regulations is an Eligibility Requirement for this RFP. See Section 4.2 of this RFP.

3.10 Sites Identified by the Company

As an alternative to a site identified by the Proposer, the Company has identified potential Sites where landowners have expressed a willingness to negotiate a lease or purchase of the land to support a renewable energy project. These Sites were identified through a Land Request for Information ("Land RFI"). Proposers will be responsible for working directly with the land owner and must secure site control with such land owner prior to submitting a Proposal. Site Control is a Threshold Requirement for this RFP. See Section 4.3 of this RFP. Additional information about the Sites identified in the Land RFI was provided to interested parties who signed Land RFI NDAs. Land RFI information remains available to other interested parties who sign the Land RFI NDA. The Land RFI is further described in Appendix G to this RFP. Proposers are not required to select a site identified in the Land RFI and as noted above may propose any site. A Proposer may meet with the Company as set forth in Section 2.2.1 if it would like to obtain similar hosting capacity information for its site as identified for the Land RFI parcels.

3.11 Project Description

3.11.1 Proposers must agree to provide all information pertaining to the design, development and construction of the Interconnection Facilities as specified in Appendix B to this RFP, including, but not limited to, the following:

- Facility size (MW_{AC} and MW_{DC}), available capacity factor;
- Proposed interconnection point;
- Site Plan, including any line extension;
- Permitting Plan;

- Single line and three line diagrams with a wet stamp by a registered Professional Engineer in Hawai‘i;
- Details of major equipment, including, but not limited to, name of manufacturer, models, key metrics, characteristics of the equipment, and performance specifications;
- Projected hourly annual energy production profile¹⁵ of the Facility (8760 hours/year);
- High-level cost information including costs for equipment, construction, engineering, Seller-Owned Interconnection Facilities, Company-Owned Interconnection Facilities, Land, and Annual O&M; and
- Weather profile (e.g., solar resource information, wind resource information, etc.) used in arriving at Net Energy Potential information.

Each Proposer must also agree to provide Project financial information, including a proposed Project finance structure in the form in Appendix B, attached to this RFP. Such information will be used to evaluate the non-price criteria, Financial Strength and Financing Plan, set forth in Attachment L of this RFP and the Financial Viability of Proposer which is a Threshold Requirement for this RFP. See Section 4.3 of this RFP. Upon selection, the Final Award Group may be requested to provide further detailed cost information if requested by the PUC or the Consumer Advocate as part of the PPA approval process. If requested such information would be provided to the PUC and Consumer Advocate pursuant to a protective order in the docket.

3.11.2 Proposers must also provide the following information in their Proposer’s Response Package template:

NEP RFP Projection: Estimated annual Net Energy Production (MWh) of the Facility for the term of the PPA, including relevant supporting information and assumptions used, such as resource measurements, energy production studies, warranted levels of annual degradation, and related information. If a Proposal is selected to the Final Award Group and a PPA is executed between the Company and the Proposer, the NEP RFP Projection will be further evaluated at several steps throughout the process as set forth in the RDG PPA, and adjustments to the Lump Sum Payment will be made accordingly. After the Facility has achieved commercial operations, baseline performance metrics will be established. The performance of the Facility will be assessed on a continuing basis.

3.11.3 The Proposer agrees that no material changes or additions to Facility from what is submitted with this Proposal will be made without the Proposer first having obtained prior written consent from the Company. Material omissions are not allowed and are an Eligibility Requirement for this RFP. See Section 4.2 of this RFP.

¹⁵ The projected hourly annual energy production profile is the projected output from the generating facility without curtailment and before any energy is directed to an energy storage facility, if one will be provided.

3.12 Confidentiality

- 3.12.1 Each prospective Proposer must submit an executed NDA in the form attached as Appendix F to this RFP by the due date for Proposals specified in the RFP Schedule in Section 3.1. The form of the NDA is not negotiable. Information designated as confidential by the Company will be provided on a limited basis, and only those prospective Proposers who have submitted an executed NDA will be considered. The full execution of agreements or other documents required is an Eligibility Requirement for this RFP. See Section 4.2 of this RFP.
- 3.12.2 Proposers must clearly identify all confidential information in their Proposals. However, Proposers should take care to designate as confidential only those portions of their Proposals that genuinely warrant confidential treatment. The Company discourages the practice of marking confidential each and every page of a Proposal. The Company will make reasonable efforts to protect any such confidential information that is clearly marked confidential. The Company reserves the right to share any information, even if marked confidential, to its agents, contractors, or the Independent Observer for the purpose of evaluating the Proposal, as set forth in the NDA.
- 3.12.3 The Company will request that the PUC issue a Protective Order to protect confidential information provided by Proposers to the Company. A copy of the Protective Order, once issued by the PUC, will be provided to Proposers. Proposers should be aware that the Company may be required to share certain confidential information contained in Proposals with the PUC, the Division of Consumer Advocacy, State of Hawai'i Department of Commerce and Consumer Affairs, and the parties to any docket instituted by the PUC, provided that recipients of confidential information have first agreed in writing to abide by the terms of the Protective Order. Notwithstanding the foregoing, no Proposer will be provided with Proposals from any other Proposer, nor will Proposers be provided with any other information contained in such Proposals or provided by or with respect to any other Proposer.

3.13 Credit Requirements Under the PPA

- 3.13.1 Proposers with whom the Company concludes PPA contract negotiations are required to post Development Period Security and Operating Period Security as set forth in the RDG PPA. Credit/Collateral Requirements are Threshold Requirements for this RFP. See Section 4.3 of this RFP.
- 3.13.2 The Development Period Security and Operating Period Security identified in the RDG PPA are minimum requirements. Proposers may not propose an amount lower than that set forth in the RDG PPA.
- 3.13.3 Each Proposer shall be required to provide a satisfactory irrevocable standby letter of credit in favor of the Company to secure Proposer's payment of all Company-Owned Interconnection Facilities costs that are payable to Company as described in Appendix G to the RDG PPA.

- 3.13.4 Proposers may be required to fund a monetary escrow account in lieu of the required Source Code Escrow required under Attachment B to the RDG PPA.

Chapter 4: Evaluation Process and Evaluation Criteria

4.1 Proposal Evaluation and Selection Process

The Company will be employing a multi-step evaluation process. Once the Proposals are received, the Proposals will be subject to a consistent and defined review, evaluation, and selection process. This Chapter provides a description of each step of the process, along with the requirements of Proposers at each step. Further details of the steps in the process are provided in Appendix L to this RFP. Figure 1 sets forth the flowchart for the proposal evaluation and selection process.

Upon receipt of the Proposals, the Company will ensure that the Proposals meet the Eligibility Requirements, and if so, will review the Proposals to ensure that the Threshold Requirements have been met. Proposals that have successfully met the initial eligibility and threshold criteria will then enter a two-phase process for Proposal evaluation, which includes the development of a Short List and then an evaluation of the selected Short List Proposals based on Best and Final Offers.

Figure 1 – Evaluation Workflow

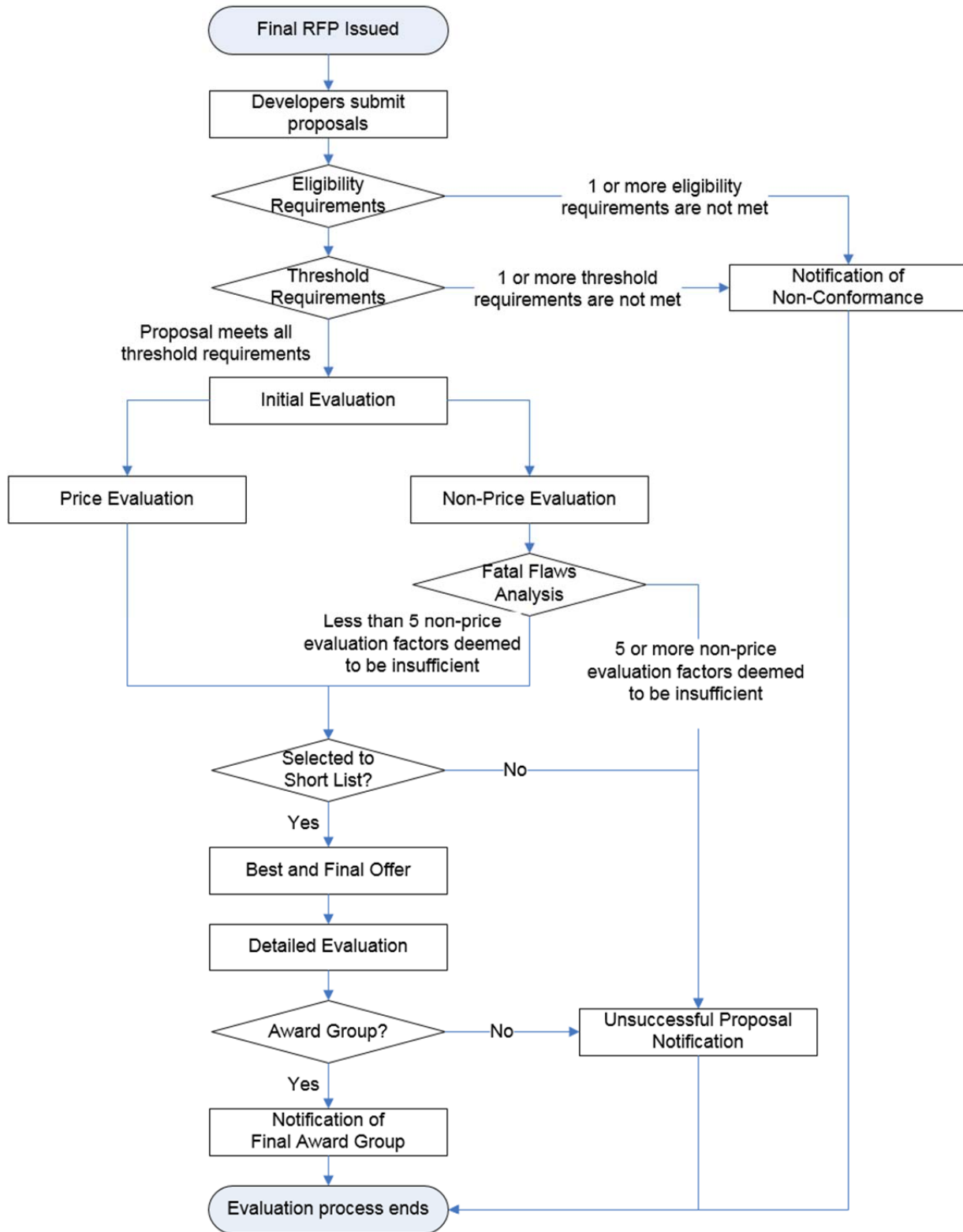

4.2 Eligibility Requirements

Upon receipt of the Proposals, each Proposal will be reviewed to ensure that it meets the following Eligibility Requirements.

- The Proposal must be received on time via the PowerAdvocate Platform.
- The non-refundable Proposal Fee must be received on time.
- The Proposal must not contain material omissions.
- The Proposal must be signed and certified by an officer or other authorized person of the Proposer.
- There must not have been, in the Company's sole determination, illegal or undue attempts by or on behalf of the Proposer or others to influence the Proposal review process.
- The Proposal must not contain misrepresentations.
- The Proposers must fully execute the agreements or other documents required pursuant to this RFP.
- The Proposer must provide a certificate of good standing from the State of Hawai'i Department of Commerce and Consumer Affairs.
- The Proposer must provide Federal and State tax clearance certificates for the Proposer.
- The Proposal must not be contingent upon changes to existing county, state or federal laws or regulations.
- The proposed Project must be located on the Island of O'ahu.
- No single point of failure from the Facility shall result in a decrease in net electrical output greater than 135 MW.
- Storage systems that are coupled with a Facility must only be charged by the renewable energy generated by the Facility and not delivered from the grid.

The Company in coordination with the IO will determine if a Proposer is allowed to cure any aspect of its Proposal or whether the Proposal would be eliminated based on failure to meet Eligibility Requirements. If it is deemed that a Proposer will have the opportunity to cure any aspect of its Proposal, the Proposer shall be given three (3) business days to cure from the date of notification of such failure.

4.3 Threshold Requirements

Proposals that meet all the Eligibility Requirements will then be evaluated to determine compliance with the Threshold Requirements, which have been designed to screen out Proposals that are insufficiently developed, lack demonstrated technology, or will impose unacceptable execution risk for the Company. This section describes the minimum requirements that all Proposals must satisfy to be eligible for further consideration in Stage 1 of the RFP Process. Proposers should provide explanations and supporting information as to how and why they believe the Project they are proposing meets each of the Threshold Requirements. Proposals that

fail to meet a Threshold Requirement will be eliminated from further consideration upon concurrence with the IO. The Threshold Requirements for this RFP are the following:

- **Site Control:** The Proposal must demonstrate that the Proposer has Site Control for all real property required for the successful implementation of a specific Proposal at a Site not controlled by the Company, including any Interconnection Facilities for which the Proposer is responsible. The need for a firm commitment is necessary to ensure that Proposals are indeed realistic and can be relied upon as the Company moves through the remainder of the RFP process. To meet this Site Control requirement, Proposers must do one of the following:
 - Provide documentation confirming that the Proposer owns 100% of the fee interest in the Site on which the Project will be situated;
 - Provide documentation confirming that the Proposer holds a leasehold interest in the Site for a term at least equal to the term of the PPA as specified in the Proposer's Proposal (taking into account the timelines set forth in this RFP for selection, negotiation, and execution of a PPA and PUC approval of a PPA); or
 - Provide documentation confirming that the Proposer has an executed option agreement to purchase the Site or to lease the Site for a term at least equal to the term of the PPA as specified in the Proposer's Proposal. This option agreement does not need to be exclusive to the Proposer at the time the Proposal is submitted, but may be contingent upon selection of the Proposal to the Final Award Group.

Where government or publicly-owned lands are part of the Site or are required for the successful implementation of the Proposal, the Proposer must provide a credible and viable plan, including evidence of any steps taken to date, to secure all necessary Site Control for the Proposal, including securing necessary and appropriate permits, approvals, rights-of-way, access, and other appurtenances necessary for the project, including but not limited to evidence of sufficient progress toward approval by the government agency or other body vested with the authority to grant such approval (as demonstrated by records of the agency).

If the Threshold Requirement for Site Control is met, Site Control will be further evaluated as a part of the Non-Price evaluation. See Section 4.4 of this RFP.

- **Performance Standards:** The proposed Facility must be able to meet the attributes identified in this RFP and the Performance Standards identified in the RDG PPA. The Company will review the Proposal information received, including the design documents and operating procured materials provided in the Proposal, and will make a determination on whether the Project as designed is able to meet the Performance Standards identified in the RDG PPA and in this RFP. Proposals should provide the information required to make such a determination in an organized manner to ensure this evaluation can be completed on a timely basis.

- **Proven Technology:** This criterion is intended as a check to ensure that the technology proposed is viable and can reasonably be relied upon to meet the objectives of this RFP. The Company will only consider Proposals utilizing technologies that have successfully reached commercial operations in multiple commercial applications (i.e., a PPA) at the scale being proposed. Technologies proposed in this RFP should be considered mature energy technologies at the scale being proposed.
Proposals should include any supporting information for the Company to assess the commercial and financial maturity of the technology being proposed.
- **Experience of the Proposer:** The Proposer, its affiliated companies, partners, and/or contractors and consultants on the Proposer's Project team must have experience in the development and operation of at least one (1) electricity generation project similar in size, scope, technology, and structure to the Project being proposed by Proposer. The Company will consider a Proposer to have reasonably met this Threshold Requirement if the Proposer can provide sufficient information to demonstrate that the member of the project team whose experience is being identified to meet this threshold criterion has a firm commitment to provide services to the Proposer.
- **Credit/Collateral Requirements:** Proposers shall agree to post Development Period Security and Operating Period Security as described in Section 3.13 of this RFP.
- **Available Transmission Circuit Capacity:** The output capacity of the Proposed project must not exceed the available capacity of the transmission-level circuit to which it will interconnect. Transmission circuit available capacity information should be confirmed with the Company during project-specific discussions regarding interconnection feasibility prior to Proposal submittal.
- **Financial Viability of Proposer:** Proposers must provide a basic financial plan for the project with details on the sources of debt and equity, capital structure, etc. Evidence is provided of general support for the project financing (i.e. interest in financing the project). Participants are reasonably strong financially. Proposer has adequate financial strength. The proposer, its affiliate or credit support provider has a moderate net worth based on its financial statements and an investment grade credit rating (BBB- and above) and has financed projects of similar magnitude.
- **Guaranteed Commercial Operations Date:** The project's Guaranteed Commercial Operations Date must be no later than December 31, 2022. This date will be a Guaranteed Milestone in Attachment K to the RDG PPA.

4.4 Initial Evaluation – Price and Non-Price Analysis

Proposals that meet the Threshold Requirements will then be subject to a price and non-price assessment. The results of the price and non-price analysis will be a relative ranking and scoring of all eligible proposals. Price-related criteria will account for sixty

percent (60%) of the total score and non-price-related criteria will account for forty percent (40%) of the total score. This 60% price-related criteria/40% non-price-related criteria weighting is consistent with previous RFPs.¹⁶ The criteria and methodology for applying the criteria are explained in Appendix L, attached to this RFP.

Appendix L provides the components of the price and non-price evaluation criteria that will be included in the initial evaluation.

The Company will employ a closed-bidding process for this solicitation in accordance with Part IV.H.3 of the Framework where some of the price and non-price evaluation models to be used will not be provided to Proposers. However, the Company will provide the Independent Observer with all necessary information to allow the Independent Observer to understand the evaluation models and to enable the Independent Observer to observe the entire analysis in order to ensure a fair process. The evaluation models will be finalized prior to the receipt of Proposals. The detailed modeling assumptions used by the Company in their models can be found in Appendix J (Modeling Assumptions Data) to the PSIP.¹⁷ The Company will review and discuss with the Independent Observer all decisions regarding the evaluation, disqualification, non-selection, and selection of Proposals, as further discussed in Section 1.4 of this RFP.

4.4.1 Initial Evaluation of the Price Related Criteria

For the price analysis, a levelized cost of energy (\$/MWh) will be calculated for each Proposal, which represents the cost of energy that is produced by the proposed Facility, that if applied over the term of the Proposal, is equal to the net present value of the anticipated payments to the Proposer when discounted back to the base year.

In order to fairly evaluate Proposals of different technologies using levelized price, at this stage in the evaluation, the Company will group Proposals into technology buckets, where the inclusion of storage results in a separate bucket (e.g., PV, PV + storage, wind, wind + storage, etc.). The Company will then award evaluation points within each technology bucket in accordance with the relative ranking of levelized price per MWh. The Proposal with the lowest levelized price in each technology bucket will receive 600 points. All other Proposals in that technology bucket will be awarded 600 points as reduced by the “Applicable Percentage,” defined below. The Applicable Percentage is the percentage by which the Proposal’s levelized price exceeds the lowest levelized price in that technology bucket. For example, if a Proposal’s levelized price is ten percent (10%) higher than the lowest levelized price in that technology bucket, the Proposal will be awarded 540 points (that is, 600 points less 10%). The result of this assessment will be a ranking and scoring of each Proposal within each technology bucket.

¹⁶ Including the evaluation weighting in the Company’s Docket No. 2013-0156, Waivers from the Framework for Competitive Bidding.

¹⁷ Appendix J to the PSIP can be found at https://www.hawaiianelectric.com/Documents/clean_energy_hawaii/grid_modernization/dkt_2014_0183_20161223_companies_PSIP_update_report_3_of_4.pdf.

4.4.2 Initial Evaluation of the Non-Price Related Criteria

For the non-price analysis, each Proposal will be evaluated on each of the non-price criteria described in Appendix L. Each non-price criterion will be weighted equally and will be scored on a one (1, poor) to five (5, highly preferable) scale. The minimum standard level for each non-price criterion is defined in Appendix L. The Company will then sum up the scores received for each non-price criterion and award evaluation points in accordance with the relative ranking of scores. The Proposal with the best combined non-price score will receive 400 points, and all other Proposals will receive points equal to the Proposal's score divided by the top score, multiplied by 400.

During the non-price criteria evaluation, a fatal flaws analysis will also be conducted such that any Proposal that is deemed not to meet the minimum standards level for five (5) or more of the eleven (11) non-price criteria will be disqualified given that the Proposal has failed to meet nearly half of the non-price factors that are indicative as to the general feasibility and operational viability of a proposed project.

4.5 Selection of the Short List

At the conclusion of both the price and non-price analysis, a total score will be calculated for each Proposal using the 60% price-related criteria/40% non-price-related criteria weighting outlined above. The price and non-price analysis, and the summation of both price and non-price scores described above, will result in a ranking of Proposals within each technology bucket.

The Company will select a Short List from the highest-scoring remaining Proposals from across the different technology buckets. The Company's objective for the Short List selection process is to identify and select Proposals that are low cost and viable Projects, as defined by the price and non-price weights at this stage in the process. The Company reserves the right to determine the number of Projects selected to the Short List. Proposals that are not included on the Short List will be released when the Short List is established. All other Proposals are eligible for selection to the Final Award Group, and if included in the Final Award Group, are eligible for signing of a PPA for the Project and approval of the PPA by the PUC.

4.6 Best and Final Offer (BAFO)

4.6.1 The Company will solicit a Best and Final Offer from Proposers selected to the Short List. Proposers will have the opportunity to update (downward only) the pricing elements of their Proposal, including the:

- Lump Sum Payment (\$/year) amount
- Energy Payment price (\$/MWh) amount

4.6.2 If a Proposer does not modify its Proposal, the original Proposal will be deemed its Best and Final Offer.

- 4.6.3 Proposers will not be allowed to increase the pricing in their Proposals to address interconnection and/or system upgrade costs or for any other reason.

4.7 Detailed Evaluation

The Best and Final Offers of the Short Listed Proposals will be further analyzed, as described in Appendix L, to determine the final group of Proposals selected in support of the Company system's needs as identified for the Island of O'ahu in the Company's PSIP Update Report: December 2016. Every Proposal on the Short List will not necessarily be included in the Final Award Group.

During the evaluation and before the Proposals advance to the Final Award Group, the Company will perform load flow analyses to determine if certain Project combinations introduce transmission circuit constraints that will factor into the selection process. This is to address the possibility that even though sufficient line capacity was identified for an individual Project, large Projects on separate transmission circuits that are in close proximity with each other could introduce additional transmission circuit constraints. The Projects selected must not have any additional constraints imposed based on the Load Flow Analysis to advance to the Final Award Group. However, the Company reserves the right, in consultation with the IO, to allow minor modifications to a Proposal to avoid such additional constraints. If such modification resulted in a reduced size of the facility, the pricing proposed would also need to be revised. Under no circumstances would a Proposer be allowed to increase their price as a result of such minor modification. In addition, the Company will ensure Projects selected as the Final Award Group are not on the same transmission circuit.

In addition, a sensitivity analysis may be performed that considers the Interconnection Costs Savings Rate included in Proposals selected to the Short List in the event that there are Proposals with approximately the same Total Net Cost to the Company in the detailed evaluations. The Company may run additional scenario analyses if requested by the IO and the time and capability exist to run such analyses.

4.8 Selection of the Final Award Group

Based on the results of the Detailed Evaluation, including the Load Flow Analysis and review of circuits, and review with the Independent Observer, the Company will select a Final Award Group from which to begin contract negotiations. The Company intends to select two (2) Projects in Stage 1. All Proposers will be notified at this stage of the evaluation process whether their Proposal is included in the Final Award Group. However, Proposal evaluation results and rankings will not be disclosed to the Proposers in the Final Award Group. Selection to the Final Award Group and/or entering into contract negotiations does not guarantee execution of a PPA. Any Project not selected to the Final Award Group may be resubmitted in Stage 2 of this RFP or in a subsequent RFP.

Unless time permits and in consultation with the Independent Observer, after the selection of the Final Award Group, if at any time a Project no longer continues, the

Company will not seek a replacement Project in Stage 1 but will seek the supply of variable renewable dispatchable generation from the Stage 2 solicitation process.

Chapter 5: Post Evaluation Process

5.1 Interconnection Requirements Study

The Company will complete Interconnection Requirements Studies for the Proposals selected to the Final Award Group to assess the costs of system upgrades necessary to integrate the Projects into the Company System. Submission of Facility models and documentation required to perform the IRS is required on the Proposal due date. Proposers must be prepared to provide any additional data necessary for the IRS within fifteen (15) days of request. Failure to provide all requested material within the time specified, or changes to the data provided after the deadline, is grounds for elimination from the Final Award Group. Proposers must pay for the cost of the IRS, which will take into consideration other Proposals selected to the Final Award Group. The IRS provides information including, but not limited to, an estimated cost for required Interconnection Facilities for a particular Project and mitigation measures. Proposers will be responsible for the actual final costs of all Seller-Owned Interconnection Facilities and Company-Owned Interconnection Facilities. No upward adjustments to pricing will be permitted as a result of the actual final costs. However, there may be downward adjustments to the pricing as a result of a lower estimated cost for required Interconnection Facilities previously provided for a particular Project. Proposers will have the opportunity to terminate the PPA in the event that the actual final costs are higher than the estimate provided by the Company. See Section 12.4 of the RDG PPA.

All Proposals selected to the Final Award Group will require a new IRS, including any Proposal at a Site where an IRS might have been previously performed in connection with other RFPs or proposed PPAs.

5.2 Contract Negotiation Process

Within five (5) business days of being notified by the Company of its intent to enter into contract negotiations, Proposers selected for the Final Award Group will be required to indicate, in writing to the Company's primary contact for this RFP, whether they intend to proceed with their Proposals. Proposers who elect to remain in the Final Award Group will be required to keep their Proposal valid through the award period. Contract negotiations will take place in parallel with the IRS process.

The Company's goal is to complete contract negotiations and submit PPAs for approval to the PUC by December 31, 2018. The IRS will not be completed at such time. The Company intends to execute and file the PPA with the PUC for approval and later amend the PPA to include the results of the IRS.

5.3 Community Outreach and Engagement

No later than in parallel with the PPA contract negotiation process, Proposers shall at minimum conduct a public meeting in the community where the proposed Project is

located, provide adequate public notice of the meeting of two weeks or more, and inform the Company of the meeting. This public meeting must include an opportunity for stakeholders and other interested parties to learn about the proposed Project, and to engage in dialogue about concerns, mitigation measures and potential community benefits, and must inform the community of the process and/or intent for input and engagements. Following the public meeting, the public will be allowed thirty (30) days to submit comments to the Company. If a PPA is executed by the Proposer and the Company, the Company's application for PUC approval of that PPA will contain an attachment including those comments. Proposers must also comply with any other requirement set forth in the RDG PPA relating to Community Outreach.

Following submission of the PUC approval application, the Company will provide another opportunity for the public to comment on the proposed Project. The Company's statement of position filed in the docket associated with the Project will contain an attachment including those comments.

5.4 PUC Approval of PPA

Any signed PPA resulting from this RFP is subject to PUC approval as described in the RDG PPA, including Article 12 and Section 29.20 thereof.

DRAFT REQUEST FOR PROPOSALS
FOR
VARIABLE RENEWABLE DISPATCHABLE GENERATION

ISLAND OF O‘AHU

FEBRUARY 2, 2018

Docket No. 2017-0352

Appendix A – Definitions



**Hawaiian
Electric**

“Best and Final Offer” or “BAFO” means the final offer from a Proposer, as further described in Section 4.6 and elsewhere in this RFP.

“Code of Conduct” means the code of conduct approved by the PUC in Docket No. 03-0372 (Decision and Order No. 23614, August 28, 2007) with respect to a Self-Build Option. An updated code of conduct was submitted to the PUC in Docket No. 2017-0352 on October 23, 2017.

“Commercial Operations” has the meaning set forth in the RDG PPA.

“Commercial Operations Date” means the date on which a Facility first achieves Commercial Operations.

“Company” means Hawaiian Electric Company, Inc., a Hawai‘i corporation.

“Company Offered Sites” means potential sites identified by the Company where landowners have expressed a willingness to negotiate a lease or purchase of the land to support a renewable energy project, as described in Section 3.10 of this RFP.

“Company-Owned Interconnection Facilities” has the meaning set forth in the RDG PPA.

“Competitive Bidding Framework” or “Framework” means the Framework for Competitive Bidding contained in Decision and Order No. 23121 issued by the Public Utilities Commission on December 8, 2006, and any subsequent orders providing for modifications from those set forth in Order No. 23121 issued December 8, 2006.

“Consumer Advocate” means the Division of Consumer Advocacy of the Department of Commerce and Consumer Affairs of the State of Hawai‘i.

“Day” means a calendar day, unless the term “business day” is used, which means calendar day excluding weekends and federal and State of Hawai‘i holidays.

“Dispatchable” means the ability to turn on or turn off a generating resource at the request of the utility’s system operators, or the ability to increase or decrease the output of a generating resource from moment to moment in response to signals from a utility’s Automatic Generation Control System, Energy Management System or similar control system, or at the request of the utility’s system operators.

“Electronic Procurement Platform” means the third-party web-based sourcing platform that will be used for the intake of Proposals and associated electronic information, storage and handling of Proposer information, and communication.

“Eligibility Requirements” has the meaning set forth in Section 4.2 of this RFP.

“Energy Payment Price” is the amount that the Company will pay the Seller for electric energy delivered to the Company in accordance with the terms and conditions of the RDG PPA on a

monthly basis as described in Attachment J to the RDG PPA. This payment will be calculated in terms of dollars per MWh.

“Facility” has the meaning set forth in the RDG PPA.

“Final Award Group” means the group of Proposers selected by the Company from the Short List, with which the Company will begin contract negotiations, based on the results of the Company’s detailed evaluation.

“Hawaiian Electric” means Hawaiian Electric Company, Inc., a Hawai‘i corporation.

“Hawaiian Electric Companies” or “Companies” means Hawaiian Electric Company, Inc. and its subsidiaries, Hawaii Electric Light Company, Inc. and Maui Electric Company, Limited.

“Hawaiian Electric System” means the electric system owned and operated by Hawaiian Electric on the island of O‘ahu (including any non-utility owned facilities) consisting of power plants, transmission and distribution lines, and related equipment for the production and delivery of electric power to the public.

“HRS” means the Hawai‘i Revised Statutes as of the date of this Request for Proposals.

“Imputed Debt” means adjustments to the debt amounts reported on financial statements prepared under generally accepted accounting principles (“GAAP”). Certain obligations do not meet the GAAP criteria of “debt” but have debt-like characteristics; therefore, credit rating agencies “impute debt and interest” in evaluating the financial ratios of a company.

“Independent Observer” has the meaning set forth in Section 1.4 of this RFP.

“Independent Power Producer” or “IPP” means an entity that owns or operates an electricity generating facility that is not included in the Company’s rate base.

“Interconnection Facilities” means the equipment and devices required to permit a Facility to operate in parallel with, and deliver electric energy to, the Company System (in accordance with applicable provisions of the Commission’s General Order No. 7, Company tariffs, operational practices, interconnection requirements studies, and planning criteria), such as, but not limited to, transmission and distribution lines, transformers, switches, and circuit breakers. Interconnection Facilities includes Company-Owned Interconnection Facilities and Seller-Owned Interconnection Facilities.

“Interconnection Requirements Study” or “IRS” means a study, performed in accordance with the terms of the IRS Letter Agreement), to assess, among other things, (1) the system requirements and equipment requirements to interconnect the Facility with the Company System, (2) the Performance Standards of the Facility, and (3) an estimate of interconnection costs and project schedule for interconnection of the Facility.

“kV” means kilovolt.

“Lump Sum Payment” has the meaning set forth in the RDG PPA. It may also be referred to as a monthly Lump Sum Payment to reflect the portion of the payment made each month.

“Mediation” means the confidential mediation conducted in Honolulu, Hawai‘i, pursuant to and in accordance with the Mediation Rules, Procedures, and Protocols of Dispute Prevention Resolution, Inc. (or its successor) or, in its absence, the American Arbitration Association then in effect.

“RDG PPA” means the PV and/or Wind Renewable Dispatchable Generation Power Purchase Agreement attached as Appendix C1 and Appendix C2 to this RFP.

“MW” means megawatt.

“MWh” means megawatt hour.

“NDA” means the Mutual Confidentiality and Non-Disclosure Agreement attached to this RFP as Appendix F.

“O&M” means operation and maintenance.

“Operating Period Security” has the meaning set forth in Section 14.4 of the RDG PPA.

“Performance Standards” means the various performance standards for the operation of the Facility to the Company as set forth in Section 3 of Appendix B, as such standards may be revised from time to time pursuant to Article 23 of the RDG PPA, and as described in Chapter 2 of this RFP.

“Point of Interconnection” has the meaning set forth in the RDG PPA.

“Power Purchase Agreement” or “PPA” means an agreement between an electric utility company and the developer of a renewable energy generation facility to sell the power generated by the facility to the electric utility company.

“Power Supply Improvement Plan” or “PSIP” means the Company’s Power Supply Improvement Plan.

“PSIP Update Report: December 2016” means the Company’s PSIP update filed on December 23, 2016 in Docket No. 2014-0183.

“Procedures Manual” means the manual approved by the PUC, which was put in place to address and to safeguard against preferential treatment or preferential access to information in a Hawaiian Electric RFP process. The Procedures Manual is attached as Appendix D to this RFP.

“Project” means a Facility proposed to Hawaiian Electric by a Proposer pursuant to this RFP.

“Proposal” means a proposal submitted to Hawaiian Electric by a Proposer pursuant to this RFP.

“Proposal Fee” means the non-refundable fee of \$10,000 for each proposal submitted as set forth in Section 1.8 of this RFP.

“Proposer” means a person or entity that submits a Proposal to Hawaiian Electric pursuant to this RFP.

“Proposer’s Response Package” means the form in which the Proposal should be submitted, which is attached as Appendix B to this RFP.

“PUC” means the State of Hawai‘i Public Utilities Commission.

“Renewable Portfolio Standards” or “RPS” means the Hawai‘i law that mandates that the Company and its subsidiaries generate or purchase certain amounts of their net electricity sales over time from qualified renewable resources. The RPS requirements in Hawai‘i are currently codified in HRS §§ 269-91 through 269-95.

“Request for Proposals” or “RFP” means a request for Proposals issued pursuant to a competitive bidding process authorized, reviewed, and approved by the PUC.

“RFP Schedule” means the schedule set forth in Table 1, Section 3.1 of this RFP.

“Self-Build Option” means a Proposal submitted by the Company that is responsive to the resource need identified in the RFP, as required by Section VI of the Framework. Note that a Self-Build Option will not be submitted in Phase 1 of this RFP.

“Self-Build Team” means agents of the Company who develop Self-Build Option proposals.

“Seller” means the entity that the Company is contracting with, as set forth in the RDG PPA.

“Seller-Owned Interconnection Facilities” has the meaning set forth in the RDG PPA.

“Short List” means the group of Proposals selected by Hawaiian Electric as described in Section 4.5 of this RFP.

“Site” means the parcel of real property on which the Facility, or any portion thereof, will be constructed and located, together with any Land Rights reasonably necessary for the construction, ownership, operation and maintenance of the Facility.

“Site Control” has the meaning set forth in Section 4.3 of this RFP.

“Threshold Requirements” has the meaning set forth in Section 4.3 of this RFP.

Any capitalized term not defined in this RFP has the meaning set forth in the RDG PPA.

DRAFT REQUEST FOR PROPOSALS
FOR
VARIABLE RENEWABLE DISPATCHABLE GENERATION

ISLAND OF O‘AHU

FEBRUARY 2, 2018

Docket No. 2017-0352

*Appendix B – Proposer’s Response Package /
IRS Data Sheet*



**Hawaiian
Electric**

Table of Contents

<i>Section</i>	<i>Description</i>	<i>Page</i>
1.0	General Instructions to Proposers:.....	1
2.0	Commercial Information Requirements	1
2.1	Required Forms	1
2.2	Proposal Summary / Contact Information	1
2.2.1	Project Summary.....	1
2.2.2	Project Contact Information	1
2.2.3	Project Characteristics	2
2.3	Executive Summary of the Proposal	32
2.4	Financial	3
2.4.1	Identification of Equity Participants.....	3
2.4.2	Evidence that the Project will be Financed, including assumptions.....	3
2.4.3	Proposer’s Organizational Structure.....	4
2.4.4	Approach and Plan for Project Financing.....	4
2.4.5	Project Financing Experience of the Proposer.....	4
2.4.6	Evidence of the Proposer’s Financial Strength	5
2.4.7	Evidence that the Proposer can Provide the Required Securities.....	5
2.4.8	Disclosure of Litigation and Disputes.....	5
2.4.9	High-level cost information	5
2.5	Model PPA Contract Exceptions	5
2.6	Site Control.....	5
2.7	Environmental Review, Permitting Plan, Environmental Compliance/Impacts.....	7
2.8	Cultural Resource Impacts.....	8
2.9	Community Outreach and Engagement.....	8
2.10	O&M Plan	9
3.0	Technical Information Requirements	9
3.1	Performance Standards	9
3.1.1	Design and Operating Information.....	9
3.1.2	Auxiliary Power Information	10
3.1.3	Capability of Meeting Performance Standards.....	10
3.1.4	Coordination of Operations	11
3.2	Available Transmission Circuit Capacity	11
3.3	Proven Technology	11
3.4	Experience and Qualifications.....	11
3.5	State of Project Development and Schedule.....	12
4.0	Pricing Information	13

1.0 General Instructions to Proposers:

The Company has elected to use the services of PowerAdvocate, a third-party electronic platform as facilitator of the RFP process. All Proposals and all relevant information must be submitted via the Power Advocate platform, as is described in the Final RFP. Proposers are requested to observe response structure, file naming convention, RFP documents and submittals, as identified on the Power Advocate platform. The platform will be configured to mirror the requirements identified in Appendix B, but formatting on the platform may vary from Appendix B. If there are any discrepancies between this Appendix B and what appears on the Power Advocate platform, the Power Advocate platform will control.

Input/submission items in the RFP that are not applicable to a specific Proposer, Proposal or Proposal variation must be clearly marked as “N/A” (Not Applicable) and a brief explanation must accompany each item so marked.

Proposers must clearly identify all confidential information in their Proposals, as described in more detail in Section 3.12 Confidentiality of the RFP.

2.0 Commercial Information Requirements

2.1 Required Forms

Proposer must upload a copy of a completed:

- Mutual Confidentiality and Non-Disclosure Agreement (Appendix F to the RFP)

2.2 Proposal Summary / Contact Information

2.2.1 Project Summary

Proposer must provide the following summary information about their Proposal:

- Project Name
- Proposed Commercial Operations Date
- Proposer Entity Name
- Proposer’s parent company, owner, sponsor, business affiliation
- Project City or Town
- Proposed interconnection point

2.2.2 Project Contact Information

Proposer must provide the contact information below for Proposer’s primary point of contact:

- Name
- Title
- Address

- Phone Number
- Mobile Phone Number (if different)
- Email Address

2.2.3 *Project Characteristics*

Proposer must provide the following summary information about their Proposal's characteristics:

- Generation Technology
- Gross and Net (MW) AC Capability of the generation facility. The net capacity (amount able to be exported to the grid) must not exceed the available capacity of the circuit to which it will interconnect. Proposers are strongly encouraged to contact the Company as described in Section 2.2.1 of this RFP to ensure the project's net capacity does not exceed the circuit's hosting capacity.
- Net Energy Potential of the Facility (MWh)
- Facility overview, including at a minimum:
 - PV
 - Number of inverters
 - Rated output of inverters (kW AC)
 - Number of PV modules
 - Rated output of PV modules (kW DC)
 - PV array design characteristics (i.e. fixed tilt, single or multi-axis tracking)
 - Wind
 - Number of turbines
 - Rated output of turbines (MW AC)
 - Storage
 - Capacity (MWh)
 - Cycling
 - Round trip efficiency
 - Other technologies
 - Comparable information on the generating unit(s)
 - Manufacturers and model numbers for all major equipment
- Estimated Life of generation facility and interconnection facilities

2.3 **Executive Summary of the Proposal**

- The Proposer is required to provide an executive summary of the Proposal. The executive summary must include an approach and description of the important elements of the Proposal and, if it is a variation of another Proposal, describe what the minor variations to the Proposal are. Refer to Section 1.8.2 of this RFP for an explanation of minor variations allowed.

2.4 **Financial**

Proposers are required to provide the following information to demonstrate FINANCIAL VIABILITY, FINANCIAL STRENGTH AND PLAN, AND FINANCIAL COMPLIANCE as they pertain to their proposal:

2.4.1 *Identification of Equity Participants*

- Who are the equity participants in the project (or the equity partners' other partners)?
- Proposer company profile information
 - DUNS Number
 - Dun & Bradstreet Rating
 - Tax ID Number
 - If applicable, in which state was the Proposer incorporated/formed?
 - If applicable, in what year was the Proposer incorporated/formed?
 - Does the Proposer have any government ownership?
 - Certificate of Good Standing from the State of Hawai'i Department of Commerce and Consumer Affairs
 - Proposer's Federal and State tax clearance
- If the Proposer has a parent entity, answer the questions below about the parent entity.
 - Parent entity profile information
 - DUNS Number
 - Dun & Bradstreet Rating
 - Tax ID Number
 - If applicable, in which state was parent entity incorporated/formed?
 - If applicable, in what year was parent entity incorporated/formed?
 - Does the parent entity have any government ownership?

2.4.2 *Evidence that the Project will be Financed, including assumptions*

- How will the project be financed?
- Is there a written commitment from the equity participants? If so, please provide a copy with confidential information redacted if necessary.

- Discuss and/or provide supporting information on any project financing guarantees.
- Does the Proposer envision any conditions precedent to project financing other than execution of the Power Purchase Agreement or any other applicable project agreements and State of Hawai'i Public Utilities Commission approval of the Power Purchase Agreement and other agreements?
 - If yes, please describe such conditions precedent to project financing and Proposer's plan to address them.
- Describe the implication of the Federal Production Tax Credits or Investment Tax Credits (or similar incentives) on the viability of the project.

2.4.3 *Proposer's Organizational Structure*

- Provide a description of the Proposer's organizational structure and associated responsibilities on the project from a financial and legal perspective, including any general and limited partners, providers of capital, and percentage interest of each party.

2.4.4 *Approach and Plan for Project Financing*

- Provide a financing plan for the project, including construction and term financing. The financing plan must address at a minimum:
 - The project's projected financial structure
 - Expected sources of debt and equity financing
 - Estimated development and capital costs
 - Evidence the project is financeable
- Proposer is required to state to the best of its knowledge that its Proposal will not (1) trigger a capital lease accounting treatment under FASB ASC 840 or (2) result in a Developer being a Variable Interest Entity (as defined in FASB ASC 810) that would trigger consolidation of such party's finances onto the Company's financial statements under FASB ASC 810, and provide supporting information to allow the Company to verify such conclusion.

2.4.5 *Project Financing Experience of the Proposer*

- Provide documentation illustrating the experience of the Proposer in securing financing for projects of similar size and technology. For each project provide the following information:
 - Project name and location
 - Project type and size
 - Date of construction and permanent financing
 - Commercial Operations Date
 - Proposer's role(s) in financing of project
 - Off-taker, term of interconnection agreement, financing structure, and major pricing terms

2.4.6 *Evidence of the Proposer's Financial Strength*

The Company reserves the right to request additional financial documents and bank references, as needed.

- Provide evidence that the Proposer has the financial resources and financial strength to complete and operate the project as planned.
- Submit Proposer's audited annual reports (from legal entity and parent company) containing the balance sheets, income statement, and statement of cash flows for the three (3) most recent fiscal years and quarterly report for the most recent quarter ended.
- List the current credit rating from Standard & Poor's, Moody's, and Fitch for the Proposer, affiliates, partners, and credit support provider.

2.4.7 *Evidence that the Proposer can Provide the Required Securities*

- The Proposer must demonstrate its ability (and/or the ability of its credit support provider) to provide the required securities, including its plan for doing so (including type of security, sources of security and a description of its credit support provider).
- Provide a description of any current credit issues regarding the Proposer or affiliate entities raised by rating agencies, banks, or accounting firms.
- Proposers must agree to provide Development Period Security and an Operating Period Security as set forth in the Model PPA.

2.4.8 *Disclosure of Litigation and Disputes*

- Proposers must disclose any litigation, disputes, and status of any lawsuits or dispute resolution related to projects owned or managed by them or any of their affiliates.

2.4.9 *High-level cost information*

- Provide high-level cost information including costs for equipment, construction, engineering, Seller-Owned Interconnection Facilities, Company-Owned Interconnection Facilities, Land, and Annual O&M.

2.5 **Model PPA Contract Exceptions**

Proposers may propose modifications to the Model PPA, including modifications that are intended to address a project's specific technology and operating characteristics. However, in general, Proposers are encouraged to accept the contract terms identified in the Model PPA where possible in order to expedite the overall RFP process and potential PPA negotiations. At a minimum, Proposers who elect to propose modifications to the Model PPA shall provide a red-line version of the Model PPA with their requested modifications as a component of their Proposals and shall also provide a detailed explanation and supporting rationale for each of the proposed modifications to the Model PPA in order to enable the Company and Independent Observer to evaluate the impact that the proposed modifications will have on the overall risk assessment associated with the evaluation of each Proposal.

In the event the Proposer does not upload redlines of the applicable form agreements, the Company will assume the terms in such form agreements are agreeable to the Proposer.

2.6 **Site Control**

The Proposal must demonstrate that the Proposer has Site Control for all real property required for the successful implementation of a specific Proposal at a Site not controlled by the Company, including any

Interconnection Facilities for which the Proposer is responsible. The need for a firm commitment is necessary to ensure that Proposals are indeed realistic and can be relied upon as the Company moves through the remainder of the RFP process.

- Demonstrate how the Proposer has met the Threshold Site Control, identified in RFP Section 4.3 Threshold Requirements by complying with one (1) of the following:
 - Provide documentation confirming that the Proposer owns 100% of the fee interest in the Site on which the Project will be situated;
 - Provide documentation confirming that the Proposer holds a leasehold interest in the Site for a term at least equal to the term of the PPA as specified in the Proposer's Proposal (taking into account the timelines set forth in this RFP for selection, negotiation, and execution of a PPA and PUC approval of a PPA); or
 - Provide documentation confirming that the Proposer has an executed option agreement to purchase the Site or to lease the Site for a term at least equal to the term of the PPA as specified in the Proposer's Proposal. This option agreement does not need to be exclusive to the Proposer at the time the Proposal is submitted, but may be contingent upon selection of the Proposal to the Final Award Group.
- Where government or publicly-owned lands are part of the Site or are required for the successful implementation of the Proposal, the Proposer must provide a credible and viable plan, including evidence of any steps taken to date, to secure all necessary Site Control for the Proposal, including securing necessary and appropriate permits, approvals, rights-of-way, access, and other appurtenances necessary for the project, including but not limited to evidence of sufficient progress toward approval by the government agency or other body vested with authority to grant such approval (as demonstrated by records of the agency). Describe the Proposer's Site Control plan or overall strategy for all real property required for the successful implementation of the proposed project.
- Provide a map of the Generator site that clearly identifies the location of the parcel on which the site is located, the tax map key number, the site boundaries (if the site does not cover the entire parcel), the total acreage of the site, the Point of Interconnection, and the relationship of the site to other local infrastructure. In addition to providing the required map, provide a site layout plan which illustrates the proposed location of all equipment and facilities on the site.
- Provide a detailed description including site sketches of how the facility will be interconnected to the Company's System (above-ground or underground) and a description of the rationale for the interconnection route.
- Identify whether the site and interconnection route are near cultural resources and implications for project completion and mitigation strategies.
- Provide evidence that the site and interconnection route are properly zoned. If they are not currently zoned properly, identify present and required zoning and/or land use designations and provide a permitting plan and timeline to secure the necessary approvals.
- Identify any rights-of-way or easements that are required for access to the site or for interconnection route. Describe the status of rights-of-way and easement acquisition, and describe the plan for securing the necessary rights-of-way, including the proposed timeline.

2.7 **Environmental Review, Permitting Plan, Environmental Compliance/Impacts**

This section addresses environmental, social, and land use issues associated with project(s) siting and operations. The purpose of this section is to identify environmental, social, and land use planning, permitting, and approval requirements, long and short term impacts, and measures that may be required to mitigate these impacts.

- Describe your overall land use and environmental permits and approvals strategy and approach to obtaining successful, positive results from the agencies and authorities having jurisdiction. The plan should explain the conceptual plans for siting, studies/assessments, permits and approvals, including a schedule which identifies the sequencing of activities and critical path.
- Identify all required discretionary and non-discretionary land use, environmental and construction permits and approvals required for development, financing, construction, and operation of the proposed project, including but not limited to, zoning changes, Environmental Assessments and/or Environmental Impacts Statements.
 - Provide a listing of such permits and approvals, indicating Federal, State or Local agencies and authorities having jurisdiction over the issuance, and the anticipated timeline for seeking and receiving the required permit and/or license. Include an explanation of your basis for the assumed timeline, and describe any situation where a permit or license for one aspect of the project may influence the timing or permit of another aspect (e.g. a case where one permit is contingent upon completion of another permit or license), if applicable.
- Describe the current or previous use of the proposed site and identify and explain any State Land Use Reclassifications necessary for Proposal siting and operations, and the associated processing/approval timeframes.
- Provide a decommissioning plan, including:
 - Developing and implementing program for recycling to the fullest extent possible, or otherwise properly disposing of, of installed infrastructure, if any, and
 - Demonstration of how restoration of the Site to its original ecological condition is guaranteed in the event of default by the Proposer in the applicable Site Control documentation.
- Provide a preliminary environmental assessment of the site (including any pre-existing environmental conditions) and potential short and long term impacts associated with, or resulting from the Proposal – including direct, indirect, and cumulative impacts associated with development, construction, operation and maintenance of the proposed project in each of the areas identified below. If alternatives have been or will be considered, those should be discussed. The assessment shall also include Proposer’s short and long term plans to mitigate such impacts an explanation of the mitigation strategies for, but not limited to, each of the major environmental areas as presented below:
 - Natural Environment:
 - Air quality
 - Biology (Natural habitats and ecosystems, flora/fauna/vegetation)
 - Climate
 - Soils
 - Topography and geology
 - Land Regulation

- Land Uses
- Flood and tsunami hazards
- Noise
- Roadways and Traffic
- Utilities
- Socio-Economic Characteristics
- Aesthetic/Visual Resources
- Solid waste
- Hazardous materials
- Water quality
- Public Safety Services (Police, Fire, Emergency Medical Services)
- Recreation
- Potential cumulative and secondary impacts

2.8 **Cultural Resource Impacts¹**

Describe the Proposer's plan to address the below requirements as it pertains to the project site and interconnection route including a status of any consultants that have been identified and/or contracted with and any assessments that have been planned or performed to date. For impacts identified for the areas listed below, provide a mitigation strategy and the expected impact on the project schedule.

- Archaeological Resources
- Cultural Practices and Resources

Provide documentation of work already done, including contracting with a consultant with expertise in this field to begin a cultural impact assessment for the project.

2.9 **Community Outreach and Engagement**

- Provide a detailed plan for community outreach and communications to gain support for or acceptance of the proposed project, including the Proposer's plans to reach out and engage with the community during project development and construction to provide project information and address local or community issues. The plan should address, but not be limited to, the following items:
 - Identify communities and other stakeholders that may be affected by the proposed project. How will they be affected? What mitigation strategies will the Proposer implement?
 - When and how will affected communities and the general public be informed about the proposed project? Describe, at a minimum, the frequency of communication, source of information, and outlets utilized.

¹ Detail the potential impacts of the Proposal on cultural resources in the short and long term and the Proposer's plan to mitigate such impacts. Parties should, at a minimum, identify (1) valued cultural, historical, or natural resources in the area in question, including the extent to which traditional and customary native Hawaiian rights are exercised in the area; (2) the extent to which those resources -- including traditional and customary native Hawaiian rights -- will be affected or impaired by the proposed action; and (3) the feasible action, if any, to be taken to reasonably protect native Hawaiian rights if they are found to exist. Proposers must provide as much information as possible to allow the Company to understand the considerations.

- Will the affected communities and the general public be given an opportunity to provide the developer with feedback and comments on the proposed project? What will the developer do with the feedback and comments received?
- Provide any documentation of local community support or opposition including any letters from local organizations, newspaper articles, or communications from local officials.
- Provide a description of community outreach efforts already taken or currently underway, including the names of organizations and stakeholders contacted about the proposed project.
- Describe any anticipated or negotiated investment in the community and other community benefits that the Proposer proposes to provide in connection with the project, along with an estimated value of the community benefits in dollars (including the cost to Proposers providing the benefits and supporting details on how those costs and benefits were derived).

2.10 **O&M Plan**

Operations and maintenance is as an important element of successful project operations. The Company is interested in projects that can demonstrate that their maintenance plan will ensure reliable operations during the term of the contract.

- Provide an operation and maintenance plan for the project that demonstrates the long term operational viability of the proposed project. The plan must include a discussion of the staffing levels proposed for the project and location of such staff, the expected role of the Proposer (Owner) or outside contractor, scheduling of major maintenance activity, maintenance funding levels, and the plan for testing equipment. Also state whether the Proposer would consider 24-hour staffing, explain how this would be done, and identify any cost impacts that are not included in the Proposal.
- Describe the Proposer's contingency plan, including the Proposer's mitigation plans to address failures. Such information should be described in the proposal to demonstrate the project's reliability with regard to potential operational issues.
- Indicate whether or not the project sponsor is willing to coordinate the maintenance schedule for the project with the annual maintenance schedule of the Company.
- Describe the status of the Proposer in securing any operation and maintenance agreements or contracts. Include a discussion of the Proposer's plan for securing a long-term operation and maintenance contract.
- Provide examples of the Proposer's experience with operation and maintenance services for other similar projects.

3.0 Technical Information Requirements

3.1 **Performance Standards**

Proposers must provide the following information regarding the project operational parameters for proposed renewable generation. If not applicable to the specific technology, the Proposer must respond with an N/A.

3.1.1 *Design and Operating Information*

- Provide a project design description, including configurations and maps

- RFP NEP Projection (MWh): The estimated annual net energy that could be produced by the facility and delivered to the Point of Interconnection over a ten year period with a probability of exceedance of 95%
- Hourly 8760 (24 hours x 365 days) generation profile for the provided RFP NEP Projection
- Resource data and a description of the resource data used in developing the RFP NEP Projection (i.e. data source(s) including any resource assessment studies prepared by independent consultants, location(s) that were analysed as they relate to the proposed project site, the resolution of the data, the accuracy of any measurement instrumentation, and the duration of the data collection).
- Sample rate of critical telemetry (i.e. frequency and voltage) based on industry experience
- Frequency response characteristic, including time of response, means of implementing
- Reactive power control when resource is at zero
- Maximum controlled ramp rate
- Startup ramp rate
- Ability to cycle on/off and provide any limitations
- Disturbance ride-through:
 - Momentary cessation (Y/N)
 - Provision of fault current- describe, provide graph

Ability to withstand subsequent events

Experience dealing with active power control, dispatch, frequency response, and ride through

3.1.2 *Auxiliary Power Information*

- Proposer must list the maximum auxiliary power requirements for:
 - Start-up
 - Normal Operations (from generator)
 - Normal Operating Shutdown
 - Forced Emergency Shutdown
 - Maintenance Outage

3.1.3 *Capability of Meeting Performance Standards*

The Companies will review the Proposal information, design documents and operating procedure materials received and will make a determination on whether the facility as designed is able to meet the Performance Standards identified in Section 3 of Appendix B to the Model PPA (Appendix C to the Final RFP).

- To the extent the Performance Standards cannot be achieved, the Proposer must specify and provide an explanation of why they cannot be met. Alternately, provide the Proposer's ability to exceed the Performance Standards and explain with detail and basis.

3.1.4 *Coordination of Operations*

- Provide a description of the control facilities required to coordinate generator operation with and between the Company's System Operator and the Company's System.
 - Provide a description of the equipment and technology used to facilitate dispatch by the Company and communicate with the Company.
- Include a description of the control and protection requirements of the generator and the Company's System.

3.2 **Available Transmission Circuit Capacity**

- Provide the Output Capacity of the Facility (MW). Please note that the output capacity of the proposed project must not exceed the available capacity of the transmission circuit to which it will interconnect.
- Provide the appropriate completed Interconnection Requirement Study Data Request worksheet.

3.3 **Proven Technology**

This criterion is intended as a check to ensure that the technology proposed is viable and can reasonably be relied upon to meet the objectives of this RFP. The Company will only consider Proposals utilizing technologies that have successfully reached commercial operations in multiple commercial applications (i.e., a PPA) at the scale being proposed. Technologies proposed in this RFP should be considered mature energy technologies at the scale proposed.

- Proposals should include any supporting information for the Company to assess the commercial and financial maturity of the technology being proposed. Provide any supporting documentation that shows examples of projects that: 1) use the technology at the scale being proposed; 2) have successfully reached commercial operations (for example, by submitting a PPA).

3.4 **Experience and Qualifications**

Proposers are required to demonstrate project experience and management capability to successfully develop and operate the project proposed. The Company is interested in a project team that has demonstrated success in the development and operation of electricity generation projects through the commercial operations stage where such projects were of a similar size (i.e., no less than half of the size of the project being proposed in response to this RFP), scope, technology and structure to the Project being proposed by the Proposer.

- Provide an organizational chart for the project that lists the project participants and identifies the management structure and responsibilities. For each of the project participants (including the Proposer, partners, and proposed contractors), provide statements that list the specific experience of the firm in: developing, financing, designing, constructing, owning, operating, and maintaining renewable energy generating facilities, or other projects of similar type, size and technology, and any evidence that the project participants have worked jointly on other projects.
- Identify those member(s) of the team the Proposer is submitting to meet the experience Threshold Requirements and demonstrate the member(s) firm commitment to provide services to the Proposer.

- Identify those members of the team with experience and qualifications including affiliates, and their principal personnel who will be involved in the project contracting to sell and deliver energy. If the Proposer consists of multiple parties, such as joint ventures or partnerships, provide this information for each party, clearly indicating the proposed role of each party, including an ownership chart indicating direct and indirect ownership, and percentage interests in the partnership or joint venture
- Provide a management chart which lists the key personnel dedicated to this project and provide biographies / resumes of the key personnel, including position, years of relevant experience, and similar project experience. Provide specifics as they relate to financing of renewable energy projects. Identify architects and engineers or provision to provide same that are licensed to practice in the State of Hawai‘i.
- Provide a listing of all photovoltaic, wind or other renewable energy projects the Proposer has successfully developed or that are currently under construction. Describe the Proposer’s role and responsibilities associated with these projects (lead developer, owner, investor, etc.). Provide the following information as part of the response:
 - Name of the project
 - Location of the project
 - Project type, size and technology
 - Commercial operation date
 - Offtaker (if applicable)
 - Current ownership
 - References with contact information(name, address, phone number, and relationship with the Proposer and with the related project

3.5 **State of Project Development and Schedule**

- Proposers are required to provide a project schedule in GANTT chart format with complete critical path activities identified for the Proposal from the Notice of Selection of the Proposal for contract negotiation to the start of Commercial Operations. The schedule must include Interconnection Requirement Study (IRS), anticipated contract negotiation period, regulatory, permitting (including but not limited to environmental and archaeological compliance), land acquisition, community outreach, interconnection (including engineering, procurement and construction), and all other important elements outside of the direct construction of the project. For each project element, list the start and end date, and include predecessors to clearly illustrate schedule dependencies. Proposers must also list and describe critical path activities and milestone events, particularly as they relate to the integration and coordination of the project components and the Company’s Electric System.
 - Proposers must ensure that the schedule provided in this section is consistent with the milestone events contained in the PPA and/or other agreements.
 - Identify the elements on the critical path. The schedule must include, at a minimum, facility contracts, construction, siting, environmental permitting (anticipated submittal and approval), cultural resource implications and mitigation plans, community outreach plan, energy resource assessment, financing, engineering, procurement, local permits and any other requirements that could influence the project schedule, and the Commercial Operations Date. The project schedule must include dates for submittal of engineering and design for review and approval, all

construction management events and construction and applicable reporting milestone events specified in the Model PPA and/or other agreements.

- Proposer must provide the construction execution strategy. This must include identification of contracting/subcontracting plans, modular construction, safety plans², quality control and assurance plan, labor availability, likely manufacturing sites and procurement plans, and similar projects where these construction methods have been used by the Proposer.
- Proposers should provide a description of any project activities that have been performed to date

4.0 Pricing Information

- Lump Sum Payment - (\$/month) the payment to be made by Company to Seller in exchange for Seller making the Net Energy Potential of the Facility available for dispatch by the Company
- Interconnection Costs Savings Rate – Amount per \$100,000 (lower than the estimate) of actual interconnection costs Variable Price - (\$/MWh) payment for electric energy delivered to the Company

² A document that describes the various safety procedures and practices that will be implemented on the project and how applicable safety regulations, standards, and work practices will be enforced on the project.

**Interconnection Requirement Study - Data Request
FOR PV GENERATION**

Updated 1/17/2018

PROJECT: _____

DATE: _____

(Nonexclusive Preliminary List)

ALL ITEMS ARE REQUIRED AND ALL RESPONSES MUST BE FILLED UNLESS NOT APPLICABLE.

	Response
1) Please provide a plan map of the Non-Utility Generation (NUG) facility. Please indicate the interconnection point to the HECO system.	
2) Please provide the following generation and load information for the NUG facility:	
a. Gross and net output of the facility	
b. Expected KW and KVAR loads including, but not limited to, generators' auxiliary load curve, process load(s) profile(s), etc.	
c. Expected minimum and maximum MW and MVAR "import from" AND "export to" HECO.	
3) Please provide Single-Line Diagram(s), Three-Line Diagram(s), and Protective Relay List & Trip Schedule for the generation and interconnection facilities:	
a. The Single-line diagram(s) and Three-line diagram (s) should include:	
i. For main and generator step up transformer(s), please show:	
• Transformer voltage and MVA ratings.	
• Transformer impedance(s).	
• Transformer winding connections and grounding. If neutrals are grounded through impedance, please show the impedance value.	
ii. The protective relaying and metering for the generators, transformers, buses, and all other main substation equipment.	
iii. For the potential transformers, please indicate the type, quantity, ratio, and accuracy rating.	
iv. For the current transformers, please indicate the type, quantity, ratio, and accuracy rating, and thermal rating factor.	
v. Auxiliary power devices (e.g. capacitors, reactors, storage systems, etc.) and their rating(s); additional inquiries may be made to obtain technical data for these devices.	
vi. For the interconnection / tie lines (overhead or underground) and the plant's generation system, please provide the following, as applicable:	
• Installation details such as cross-section(s), plan and profiles, etc.	
• Conductor data such as size, insulation, length etc.	
• Continuous and emergency current ratings.	
• Voltage rating (nominal and maximum KV).	
• BIL rating.	
• Positive, negative, and zero-sequence impedances (resistance, reactance, and susceptance)	
• Capacitance or charging current.	
• Short-circuit current capability.	
vii. Include station power for facility and all applicable details.	
viii. All applicable notes pertaining to the design and operation of the facility.	
b. The Protective relay list & trip schedule should list the protected equipment; the relay description, type, style number, quantity, ANSI Device No., and range; and the breaker(s)/switching device(s) tripped, for both the generator protection and the interconnection facilities protection.	
c. Please provide both a paper and an electronic version (e.g. dgn, dxf, or pdf) of the single-line diagram(s) and the protective relay list & trip schedule.	
d. Single-line diagrams should be provided for both the generation plant and the interconnection substation.	

**Interconnection Requirement Study - Data Request
FOR PV GENERATION**

Updated 1/17/2018

PROJECT: _____

DATE: _____

(Nonexclusive Preliminary List)

ALL ITEMS ARE REQUIRED AND ALL RESPONSES MUST BE FILLED UNLESS NOT APPLICABLE.

		Response
4)	For the PV Inverter Based Generating Facility, please provide the following data:	
	a. Inverter manufacturer, Type, Size, Impedances. Attach copy of inverter data sheet.	
	b. Power Factor Range Capability	
	c. Inverter Reactive Power Capability Curve	
	d. Auxillary loads (P, Q, Power Factor)	
	e. Ramp rates (up, down) Typical and Measured Proxy Data	
	f. Inverter's Internal Isolation Transformer Grounding Method, if used (i.e. effectively grounded, resonant grounded, low inductance grounded, high-resistance grounded, low-resistance grounded, ungrounded). If the transformer is not solidly grounded, provide the impedance value for the grounding neutral and the impedance for the isolation transformer.	
	g. Diagram for Inverter's internal isolation transformer	
	h. Switching and service restoration practice	
	i. Protection data (voltage ride-through and trip settings, frequency ride-through and trip settings etc.). Include setpoint and clearing time ranges for voltage and frequency settings.	
	j. Details of filters etc. at Point of Interconnection	
	k. Description of harmonic spectrum of inverter injection (order, magnitude)	
	l. Description of PV inverter with respect to varying levels of solar irradiance	
5)	Energy Storage System, if applicable	
	a. Operation characteristics	
	b. Voltage level	
	c. Capacity (how long and how much can the battery support)	
	d. Deployment strategy/schedule	
	e. Energy storage system data sheet	
6)	For the PV plant's collector system, please provide the following, as applicable:	
	a. Conductor data such as size, insulation, etc.	
	b. Continuous and emergency current ratings.	
	c. Voltage rating (nominal and maximum kV).	
	d. BIL rating.	
	e. Positive, negative, and zero-sequence impedances (resistance, reactance, and susceptance).	
	f. Capacitance or charging current.	
	g. Short-circuit current capability.	

**Interconnection Requirement Study - Data Request
FOR PV GENERATION**

Updated 1/17/2018

PROJECT: _____

DATE: _____

(Nonexclusive Preliminary List)

ALL ITEMS ARE REQUIRED AND ALL RESPONSES MUST BE FILLED UNLESS NOT APPLICABLE.

		Response
7)	Please provide the following software models that accurately represent the Facility:	
	a. Validated PSS/E load flow model up to the point of interconnection. The PSS/E model shall include the main transformer, collection system, generator step-up transformers, inverter systems, and any other components including capacitor banks, energy storage systems, DVAR, etc. An equivalent representation of the collection system, generator step-up transformers, and inverter systems is acceptable. Documentation on the model shall be provided.	
	b. Validated PSS/E dynamic model for the inverter; and other components including energy storage system, DVAR, etc. if applicable. The inverter model shall include the generator/converter, electrical controls, plant-level controller, and protection relays. Generic and Detailed models shall be provided. Documentation on the model(s) shall be provided, including the PSS/E dyre file with model parameters.	
	i. Generic models shall parameterize models available within the PSS/E standard model library.	
	ii. Detailed models shall be supplied by the vendor/manufacturer as user-written models. The uncompiled source code for the user-written model shall be provided to ensure compatability with future versions of PSS/E. In lieu of the uncompiled source code, a compiled object file and applicable library files shall be provided in PSS/E versions 33 AND 34 format. Updates of the object file compatible with future PSS/E versions must be provided as requested for the life of the project as written in the power purchase agreement. Documentation shall include the characteristics of the model, including block diagrams, values, names for all model parameters, and a list of all state variables.	
	c. Validated PSCAD model of the inverter; and other components including energy storage system, DVAR, auxiliary plant controllers, etc. if applicable. Documentation on the model(s) shall be provided. Refer to PSCAD Technical Memo for model requirements.	
	d. Overlaid plots validating the performance of the three dynamic models for a three-phase fault. Plots shall include voltage, real and reactive power, real and reactive current.	
	e. Validated Aspen Oneliner short circuit model that accurately represents the facility (including energy storage system if applicable), and is valid for all faults conditions anywhere on the Utility system. Documentation on the model(s) shall be provided. (OTHERWISE SEE ADDITIONAL TABS FOR REQUIRED INFORMATION TO MODEL INVERTER)	
8)	For the main transformer and generator step-up transformers, please provide:	
	a. Transformer voltage and MVA ratings, and available taps. Attach copy of transformer test report or data sheet	
	b. The tap settings used.	
	c. The LTC Control Scheme.	
	d. Transformer winding connections and grounding used. If the transformer is not solidly grounded, provide the impedance value for the grounding method.	
	e. Positive, negative, and zero sequence impedance values.	
9)	For the circuit breakers and fault-clearing switching devices, including the generator breakers, please provide:	
	a. The voltage, continuous current and interrupting capability ratings.	
	b. The trip speed (time to open).	

**Interconnection Requirement Study - Data Request
FOR PV GENERATION**

Updated 1/17/2018

PROJECT: _____

DATE: _____

(Nonexclusive Preliminary List)

ALL ITEMS ARE REQUIRED AND ALL RESPONSES MUST BE FILLED UNLESS NOT APPLICABLE.

		Response
10)	For the power fuses, please provide:	
	a. The manufacturer, type, size, and interrupting capability.	
	b. The minimum melt and total clearing curves.	
11)	For the protective relaying, please provide:	
	a. Data for the CTs used with the relaying including the manufacturer, type of CT, accuracy class, and thermal rating factor.	
	b. Data for the PTs used with the relaying including the manufacturer, type of PT, voltage ratings, and quantity.	
12)	Please provide protective relay settings for existing and proposed generators, including but not limited to, reverse power, negative sequence, over and underfrequency, over and under voltage, volts per hertz, etc.	

Updated 6/15/11

Instructions:

Please fill in the data in the green blanks below

(Note: This does not include the internal isolation transformer, if used)

[1] Maximum rated output power = kVA

[2] Impedances in **Per Unit** based on kVA from [1]

	R	X
Subtransient =	<input type="text"/>	<input type="text"/>
Transient =	<input type="text"/>	<input type="text"/>
Synchronous =	<input type="text"/>	<input type="text"/>
Negative Sequence =	<input type="text"/>	<input type="text"/>
Zero Sequence =	<input type="text"/>	<input type="text"/>

[3] Neutral impedance (if any) in actual **Ohms**:

R	X
<input type="text"/>	<input type="text"/>

NOTE: These parameters should reflect the inverter response for all types of faults at any point on the electrical system to which the inverter is connected. This includes faults at the inverter output terminals, and also on the 138 kV transmission system. If the stated parameters do not cover this range, please state the adjustments needed to these parameters to accurately represent the inverter response across this range.

These parameters will be used to model the inverter in the Aspen Oneliner program as shown in the sample dialog box below:

Generating Unit Info

ID= Unit rating= MVA

Impedances (pu based on unit MVA)

Subtransient	<input type="text" value="0.1"/>	+j	<input type="text" value="0.1"/>	<input type="button" value="Fill"/>
Transient	<input type="text" value="0.1"/>	+j	<input type="text" value="0.1"/>	
Synchronous	<input type="text" value="0.1"/>	+j	<input type="text" value="0.1"/>	
- sequence	<input type="text" value="0.15"/>	+j	<input type="text" value="0.15"/>	
o sequence	<input type="text" value="9999.0"/>	+j	<input type="text" value="9999.0"/>	

Neutral Impedance (in actual Ohms)

<input type="text" value="0.0"/>	+j	<input type="text" value="0.0"/>
----------------------------------	----	----------------------------------

Scheduled generation. Enter MVAR for PQ buses only

MW= <input type="text" value="0.0"/>	MVAR= <input type="text" value="0.0"/>
--------------------------------------	--

P and Q limits (MW and MVAR)

Pmax= <input type="text" value="9999.0"/>	Qmax= <input type="text" value="9999.0"/>
Pmin= <input type="text" value="-9999.0"/>	Qmin= <input type="text" value="-9999.0"/>

Updated 6/15/11

Instructions:

Please fill in the data in the green blanks below

[1] Internal open circuit voltage
Magnitude = Per Unit
Angle = Degrees

[2] AC Output Current Limit = Amps

NOTE: These parameters should reflect the inverter response for all types of faults at any point on the electrical system to which the inverter is connected. This includes faults at the inverter output terminals, and also on the 138 kV transmission system. If the stated parameters do not cover this range, please state the adjustments needed to these parameters to accurately represent the inverter response across this range.

These parameters will be used to model the inverter in the Aspen Oneliner program as shown in the sample dialog box below:

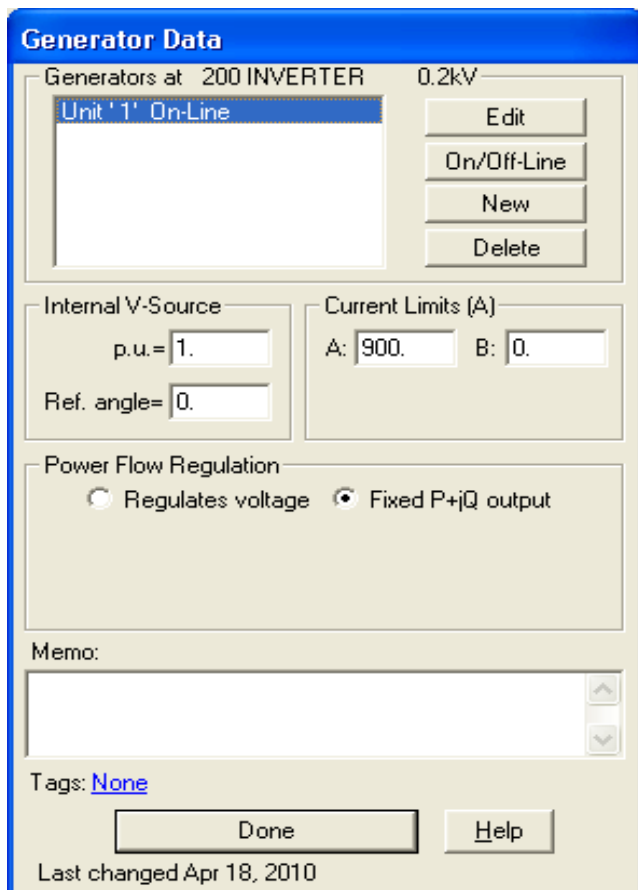

**Interconnection Requirement Study - Data Request
FOR WIND GENERATION**

Updated 1/17/2018

PROJECT: _____

DATE: _____

(Nonexclusive Preliminary List)

ALL ITEMS ARE REQUIRED AND ALL RESPONSES MUST BE FILLED UNLESS NOT APPLICABLE.

	Response
1) Please provide a plan map of the Non-Utility Generation (NUG) facility. Please indicate the interconnection point to the HECO system.	
2) Please provide the following generation and load information for the NUG facility:	
a. Gross and net output of the facility	
b. Expected KW and KVAR loads including, but not limited to, generators' auxiliary load curve, process load(s) profile(s), etc.	
c. Expected minimum and maximum MW and MVAR "import from" AND "export to" HECO.	
3) Please provide Single-Line Diagram(s), Three-Line Diagram(s), and Protective Relay List & Trip Schedule for the generation and interconnection facilities:	
a. The Single-line diagram(s) and Three-line diagram (s) should include:	
i. For main and generator step up transformer(s), please show:	
• Transformer voltage and MVA ratings.	
• Transformer impedance(s).	
• Transformer winding connections and grounding. If neutrals are grounded through impedance, please show the impedance value.	
ii. The protective relaying and metering for the generators, transformers, buses, and all other main substation equipment.	
iii. For the potential transformers, please indicate the type, quantity, ratio, and accuracy rating.	
iv. For the current transformers, please indicate the type, quantity, ratio, and accuracy rating, and thermal rating factor.	
v. Auxiliary power devices (e.g. capacitors, reactors, storage systems, etc.) and their rating(s); additional inquiries may be made to obtain technical data for these devices.	
vi. For the interconnection / tie lines (overhead or underground) and the plant's generation system, please provide the following, as applicable:	
• Installation details such as cross-section(s), plan and profiles, etc.	
• Conductor data such as size, insulation, length etc.	
• Continuous and emergency current ratings.	
• Voltage rating (nominal and maximum KV).	
• BIL rating.	
• Positive, negative, and zero-sequence impedances (resistance, reactance, and susceptance)	
• Capacitance or charging current.	
• Short-circuit current capability.	
vii. Include station power for facility and all applicable details.	
viii. All applicable notes pertaining to the design and operation of the facility.	
b. The Protective relay list & trip schedule should list the protected equipment; the relay description, type, style number, quantity, ANSI Device No., and range; and the breaker(s)/switching device(s) tripped, for both the generator protection and the interconnection facilities protection.	
c. Please provide both a paper and an electronic version (e.g. dgn, dxf, or pdf) of the single-line diagram(s) and the protective relay list & trip schedule.	
d. Single-line diagrams should be provided for both the generation plant and the interconnection substation.	

**Interconnection Requirement Study - Data Request
FOR WIND GENERATION**

Updated 1/17/2018

PROJECT: _____

DATE: _____

(Nonexclusive Preliminary List)

ALL ITEMS ARE REQUIRED AND ALL RESPONSES MUST BE FILLED UNLESS NOT APPLICABLE.

		Response
4)	For the Wind Generating Facility, please provide the following data:	
	a. Turbine manufacturer, Type, Size, Impedances. Attach copy of turbine data sheet.	
	b. Power Factor Range Capability	
	c. Turbine Reactive Power Capability Curve	
	d. Auxillary loads (P, Q, Power Factor)	
	e. Ramp rates (up, down) Typical and Measured Proxy Data	
	f. Grounding Method (i.e. effectively grounded, resonant grounded, low inductance grounded, high-resistance grounded, low-resistance grounded, ungrounded). If the transformer is not solidly grounded or ungrounded, provide the impedance value for the grounding neutral, if applicable.	
	g. Provide grounding diagram.	
	h. Switching and service restoration practice	
	i. Protection data (voltage ride-through and trip settings, frequency ride-through and trip settings etc.). Include setpoint and clearing time ranges for voltage and frequency settings.	
	j. Details of filters etc. at Point of Interconnection	
	k. Description of harmonic spectrum of inverter injection (order, magnitude)	
5)	Energy Storage System, if applicable	
	a. Operation characteristics	
	b. Voltage level	
	c. Capacity (how long and how much can the battery support)	
	d. Deployment strategy/schedule	
	e. Energy storage system data sheet	
6)	For the Wind plant's collector system, please provide the following, as applicable:	
	a. Conductor data such as size, insulation, etc.	
	b. Continuous and emergency current ratings.	
	c. Voltage rating (nominal and maximum kV).	
	d. BIL rating.	
	e. Positive, negative, and zero-sequence impedances (resistance, reactance, and susceptance).	
	f. Capacitance or charging current.	
	g. Short-circuit current capability.	

**Interconnection Requirement Study - Data Request
FOR WIND GENERATION**

Updated 1/17/2018

PROJECT: _____

DATE: _____

(Nonexclusive Preliminary List)

ALL ITEMS ARE REQUIRED AND ALL RESPONSES MUST BE FILLED UNLESS NOT APPLICABLE.

		Response
7)	Please provide the following software models that accurately represent the Facility:	
	a. Validated PSS/E load flow model up to the point of interconnection. The PSS/E model shall include the main transformer, collection system, generator step-up transformers, wind turbines, and any other components including capacitor banks, energy storage systems, DVAR, etc. An equivalent representation of the collection system, generator step-up transformers, and turbines is acceptable. Documentation on the model shall be provided.	
	b. Validated PSS/E dynamic model for the wind turbine; and other components including energy storage system, DVAR, etc. if applicable. The wind turbine model shall include the generator/converter, electrical controls, plant-level controller, protection relays, and mechanical systems that impact its electrical performance. Generic and Detailed models shall be provided. Documentation on the model(s) shall be provided, including the PSS/E dyre file with model parameters.	
	i. Generic models shall parameterize models available within the PSS/E standard model library.	
	ii. Detailed models shall be supplied by the vendor/manufacturer as user-written models. The uncompiled source code for the user-written model shall be provided to ensure compatability with future versions of PSS/E. In lieu of the uncompiled source code, a compiled object file and applicable library files shall be provided in PSS/E versions 33 AND 34 format. Updates of the object file compatible with future PSS/E versions must be provided as requested for the life of the project as written in the power purchase agreement. Documentation shall include the characteristics of the model, including block diagrams, values, names for all model parameters, and a list of all state variables.	
	c. Validated PSCAD model of the wind turbine; and other components including energy storage system, DVAR, etc, if applicable. Documentation on the model(s) shall be provided. Refer to PSCAD Technical Memo for model requirements.	
	d. Overlaid plots validating the performance of the three dynamic models for a three-phase fault. Plots shall include voltage, real and reactive power, real and reactive current.	
	e. Validated Aspen Oneliner short circuit model that accurately represents the facility (including energy storage system if applicable), and is valid for all faults conditions anywhere on the Utility system. Documentation on the model(s) shall be provided. (OTHERWISE SEE ADDITIONAL TABS FOR REQUIRED INFORMATION TO MODEL INVERTER)	
8)	For the main transformer and generator step-up transformers, please provide:	
	a. Transformer voltage and MVA ratings, and available taps. Attach copy of transformer test report or data sheet	
	b. The tap settings used.	
	c. The LTC Control Scheme.	
	d. Transformer winding connections and grounding used. If the transformer is not solidly grounded, provide the impedance value for the grounding method.	
	e. Positive, negative, and zero sequence impedance values.	
9)	For the circuit breakers and fault-clearing switching devices, including the generator breakers, please provide:	
	a. The voltage, continuous current and interrupting capability ratings.	
	b. The trip speed (time to open).	

**Interconnection Requirement Study - Data Request
FOR WIND GENERATION**

Updated 1/17/2018

PROJECT: _____

DATE: _____

(Nonexclusive Preliminary List)

ALL ITEMS ARE REQUIRED AND ALL RESPONSES MUST BE FILLED UNLESS NOT APPLICABLE.

		Response
10)	For the power fuses, please provide:	
	a. The manufacturer, type, size, and interrupting capability.	
	b. The minimum melt and total clearing curves.	
11)	For the protective relaying, please provide:	
	a. Data for the CTs used with the relaying including the manufacturer, type of CT, accuracy class, and thermal rating factor.	
	b. Data for the PTs used with the relaying including the manufacturer, type of PT, voltage ratings, and quantity.	
12)	Please provide protective relay settings for existing and proposed generators, including but not limited to, reverse power, negative sequence, over and underfrequency, over and under voltage, volts per hertz, etc.	

Updated 6/15/11

Instructions:

Please fill in the data in the green blanks below

(Note: This does not include the internal isolation transformer, if used)

[1] Maximum rated output power = kVA

[2] Impedances in **Per Unit** based on kVA from [1]

	R	X
Subtransient =	<input type="text"/>	<input type="text"/>
Transient =	<input type="text"/>	<input type="text"/>
Synchronous =	<input type="text"/>	<input type="text"/>
Negative Sequence =	<input type="text"/>	<input type="text"/>
Zero Sequence =	<input type="text"/>	<input type="text"/>

[3] Neutral impedance (if any) in actual **Ohms**:

R	X
<input type="text"/>	<input type="text"/>

NOTE: These parameters should reflect the inverter response for all types of faults at any point on the electrical system to which the inverter is connected. This includes faults at the inverter output terminals, and also on the 138 kV transmission system. If the stated parameters do not cover this range, please state the adjustments needed to these parameters to accurately represent the inverter response across this range.

These parameters will be used to model the inverter in the Aspen Oneliner program as shown in the sample dialog box below:

Generating Unit Info

ID= Unit rating= MVA

Impedances (pu based on unit MVA)

Subtransient	<input type="text" value="0.1"/>	+j	<input type="text" value="0.1"/>	<input type="button" value="Fill"/>
Transient	<input type="text" value="0.1"/>	+j	<input type="text" value="0.1"/>	
Synchronous	<input type="text" value="0.1"/>	+j	<input type="text" value="0.1"/>	
- sequence	<input type="text" value="0.15"/>	+j	<input type="text" value="0.15"/>	
o sequence	<input type="text" value="9999.0"/>	+j	<input type="text" value="9999.0"/>	

Neutral Impedance (in actual Ohms)

<input type="text" value="0.0"/>	+j	<input type="text" value="0.0"/>
----------------------------------	----	----------------------------------

Scheduled generation. Enter MVAR for PQ buses only

MW= <input type="text" value="0.0"/>	MVAR= <input type="text" value="0.0"/>
--------------------------------------	--

P and Q limits (MW and MVAR)

Pmax= <input type="text" value="9999.0"/>	Qmax= <input type="text" value="9999.0"/>
Pmin= <input type="text" value="-9999.0"/>	Qmin= <input type="text" value="-9999.0"/>

Updated 6/15/11

Instructions:

Please fill in the data in the green blanks below

[1] Internal open circuit voltage
Magnitude = Per Unit
Angle = Degrees

[2] AC Output Current Limit = Amps

NOTE: These parameters should reflect the inverter response for all types of faults at any point on the electrical system to which the inverter is connected. This includes faults at the inverter output terminals, and also on the 138 kV transmission system. If the stated parameters do not cover this range, please state the adjustments needed to these parameters to accurately represent the inverter response across this range.

These parameters will be used to model the inverter in the Aspen Oneliner program as shown in the sample dialog box below:

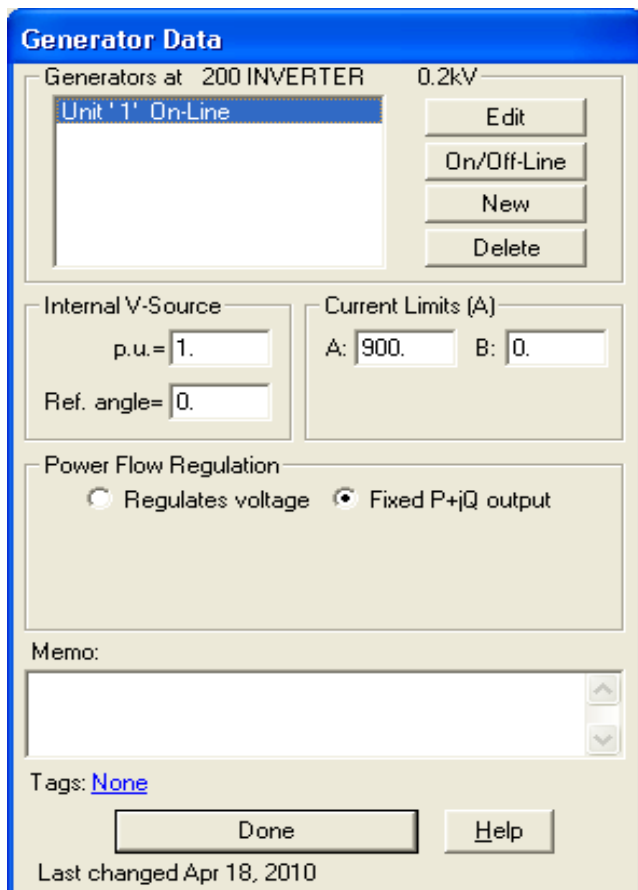

FOR SYNCHRONOUS, ASYNCHRONOUS, INDUCTION GENERATORS

PROJECT:

DATE:

Preliminary

Interconnection Requirement Study - Data Request

(Nonexclusive Preliminary List)

*****ALL ITEMS ARE REQUIRED AND ALL RESPONSES MUST BE FILLED UNLESS NOT APPLICABLE.*****

	Response
1) Please provide Single-Line Diagram(s), Three-Line Diagram(s), and Protective Relay List & Trip Schedule for the generation and interconnection facilities: General SLD Comments and Questions	
a. The Single-line diagram(s) and Three-line diagram (s) should include:	
i. For main and generator step up transformer(s), please show: <ul style="list-style-type: none"> • Transformer voltage and MVA ratings. 	
<ul style="list-style-type: none"> • Transformer impedance(s). 	
<ul style="list-style-type: none"> • Transformer winding connections and grounding. If neutrals are grounded through impedance, please show the impedance value. 	
ii. The protective relaying and metering for the generators, transformers, buses, and all other main substation equipment.	
iii. For the potential transformers, please indicate the type, quantity, ratio, and accuracy rating.	
iv. For the current transformers, please indicate the type, quantity, ratio, and accuracy rating, and thermal rating factor.	
v. Auxiliary power devices (e.g. capacitors, reactors, storage systems, etc.) and their rating(s); additional inquiries may be made to obtain technical data for these devices.	
vi. For the interconnection / tie lines (overhead or underground) and the plant's generation system, please provide the following, as applicable: <ul style="list-style-type: none"> • Installation details such as cross-section(s), plan and profiles, etc. 	
<ul style="list-style-type: none"> • Conductor data such as size, insulation, etc. 	
<ul style="list-style-type: none"> • Continuous and emergency current ratings. 	
<ul style="list-style-type: none"> • Voltage rating (nominal and maximum KV). 	
<ul style="list-style-type: none"> • BIL rating. 	
<ul style="list-style-type: none"> • Positive, negative, and zero-sequence impedances (resistance, reactance, and susceptance) 	
<ul style="list-style-type: none"> • Capacitance or charging current. 	
<ul style="list-style-type: none"> • Short-circuit current capability. 	
vii. Include station power for facility and all applicable details.	
viii. All applicable notes pertaining to the design and operation of the facility.	
b. The Protective relay list & trip schedule should list the protected equipment; the relay description, type, style number, quantity, ANSI Device No., and range; and the breaker(s)/switching device(s) tripped, for both the generator protection and the interconnection facilities protection.	

FOR SYNCHRONOUS, ASYNCHRONOUS, INDUCTION GENERATORS

PROJECT:

DATE:

Preliminary

Interconnection Requirement Study - Data Request

(Nonexclusive Preliminary List)

*****ALL ITEMS ARE REQUIRED AND ALL RESPONSES MUST BE FILLED UNLESS NOT APPLICABLE.*****

	Response
c. Please provide both a paper and an electronic version (e.g. dgn, dxf, or pdf) of the single-line diagram(s) and the protective relay list & trip schedule.	
d. Single-line diagrams should be provided for both the generation plant and the interconnection substation.	
2) Please provide a plan map of the Non Utility Generation (NUG) facilities; please indicate the interconnection point to the HECO system.	
3) For the power transformers including the generator step-up transformers, please provide:	
a. Transformer voltage and MVA ratings, and available taps. Attach copy of transformer test report or data sheet	
b. The tap settings used.	
c. The LTC Control Scheme.	
d. Transformer winding connections and grounding used. If the transformer is not solidly grounded, provide the impedance value for the grounding method.	
e. Positive, negative, and zero sequence impedance values.	
4) For the circuit breakers and fault-clearing switching devices, including the generator breakers, please provide:	
a. The voltage, continuous current and interrupting capability ratings.	
b. The trip speed (time to open).	

FOR SYNCHRONOUS, ASYNCHRONOUS, INDUCTION GENERATORS

PROJECT:

DATE:

Preliminary

Interconnection Requirement Study - Data Request

(Nonexclusive Preliminary List)

*****ALL ITEMS ARE REQUIRED AND ALL RESPONSES MUST BE FILLED UNLESS NOT APPLICABLE.*****

		Response
5)	For the power fuses, please provide:	
	a. The manufacturer, type, size, and interrupting capability.	
	b. The minimum melt and total clearing curves.	
6)	For the protective relaying, please provide:	
	a. Data for the CTs used with the relaying including the manufacturer, type of CT, accuracy class, and thermal rating factor.	
	b. Data for the PTs used with the relaying including the manufacturer, type of PT, voltage ratings, and quantity.	
7)	Please provide protective relay settings for existing and proposed generators, including but not limited to, reverse power, negative sequence, over and underfrequency, over and under voltage, volts per hertz, etc.	
8)	For the new generator(s), please provide:	
	a. Manufacturer and model of the generator.	
	b. Generator type (e.g. synchronous, induction, etc.). If synchronous, indicate round rotor or salient pole.	
	c. Generator voltage, MVA, and power-factor ratings.	
	d. Validated PSSE and Synergi load flow and dynamic model. Documentation on the models should also be provided.	
	e. Please provide the following: <ul style="list-style-type: none"> i. The time constants T'do, T'qo, T"do, T"qo. 	

FOR SYNCHRONOUS, ASYNCHRONOUS, INDUCTION GENERATORS

PROJECT:

DATE:

Preliminary

Interconnection Requirement Study - Data Request

(Nonexclusive Preliminary List)

*****ALL ITEMS ARE REQUIRED AND ALL RESPONSES MUST BE FILLED UNLESS NOT APPLICABLE.*****

	Response
ii. The reactance values for the X_d , X_q , X_2 , X_0 , X'_d , X'_q , X''_d , X''_q , and X_L . Please provide both saturated (for short-circuit calculations) and unsaturated (for dynamics modeling) values where appropriate.	
iii. The inertia, H , for the generator/turbine/exciter combination.	
iv. The generator saturation characteristics.	
v. Starting power factor	
vi. Starting current	
vii. Starting torque	
viii. Full load speed/slip	
ix. Full load speed/slip	
x. Full load efficiency	
xi. Pull out torque	
f. Generator V/HZ curve.	
g. Negative Sequence Current Limit curve (I_2^2t).	
h. Generator auxiliary load curve.	
i. Generator (MW/MVAR) capability curve(s).	
j. The type of grounding used with the generator. If the generator is not solidly grounded, provide the grounding method details and equipment ratings.	
k. Validated Aspen Oneliner short circuit model that accurately represents the facility, and is valid for all faults conditions anywhere on the Utility system.	

9) **For the generators' excitation system, please provide:**

a. For synchronous generators, please provide the following.	
i. Exciter type, manufacturer, model, and voltage/current ratings.	
ii. Excitation system response ratio and ceiling factor.	
iii. Validated PSSE excitation system model with parameter values representative of the excitation system. Documentation of the model should also be provided.	
iv. Please indicate whether the excitation system has a maximum excitation (OEL) limiter, a minimum excitation (UEL) limiter, and/or a power system stabilizer (PSS); please provide the device settings if device(s) present.	
v. Description of the control mode of the excitation system, e.g. on voltage regulation, power factor regulation, etc.	
b. For asynchronous generators, please describe the method of excitation and its control. Note additional inquiries may be made to obtain technical data for such method.	

10) **For generator's prime mover, please provide:**

a. Validated PSSE and Synergi governor system model with parameter values representative of the prime mover system. Documentation of the model should	
b. Description of the control mode of the prime mover, e.g. on droop control, load control, etc.	

FOR SYNCHRONOUS, ASYNCHRONOUS, INDUCTION GENERATORS

PROJECT:

DATE:

Preliminary

Interconnection Requirement Study - Data Request

(Nonexclusive Preliminary List)

*****ALL ITEMS ARE REQUIRED AND ALL RESPONSES MUST BE FILLED UNLESS NOT APPLICABLE.*****

		Response
11)	<p>Please provide the following generation and load information for the NUG facilities:</p> <p>a. Expected KW and KVAR loads including, but not limited to, generators' auxiliary load curve, process load(s) profile(s), etc.</p> <p>b. Expected minimum and maximum MW and MVAR "import from" AND "export to" HECO.</p> <p>c. Gross and net output of the facility</p>	
12)	<p>In addition to the items mentioned above, please provide the following for PSS/E models:</p> <p>a. Object files and IPLANS for user written models, and applicable library files. The uncompiled source code for object files shall be provided to ensure compatability with future versions of PSS/E. In lieu of the uncompiled object file source code, compiled object file updates compatible with future PSS/E versions shall be provided as requested for the life of the project.</p>	
13)	<p>In addition to PSS/E, other power system analysis tools are required to study events that cannot accurately be modeled in PSS/E due to limitations of the program (e.g. sub-cycle behavior). Data compatible with the following tools shall be provided:</p> <p>a. Time domain tools - PSCAD® or electro-magnetic transient program (EMTP). Documentation on the model shall also be provided.</p> <p>b. ASPEN One-Liner (VALIDATED MODEL TO BE PROVIDED)</p>	

NOTE: **Equivalent models other than PSSE may be required if the PSSE model cannot be converted properly.

DRAFT REQUEST FOR PROPOSALS
FOR
VARIABLE RENEWABLE DISPATCHABLE GENERATION

ISLAND OF O‘AHU

FEBRUARY 2, 2018

Docket No. 2017-0352

Appendix C1 – Model PV RDG PPA



**Hawaiian
Electric**

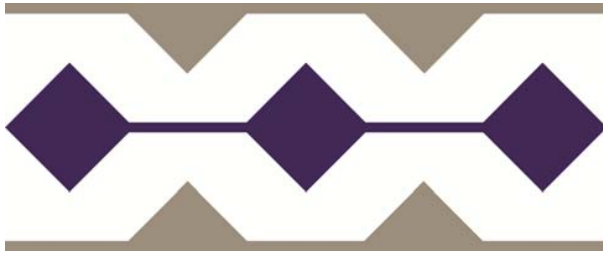

**Hawaiian
Electric**

Model
Power Purchase Agreement
For
Renewable Dispatchable Generation
(PV)

February 2018

Drafting Note: This document has been prepared for Hawaiian Electric Company, Inc. projects. It will be adapted for use for by Hawaii Electric Light Company Inc. and Maui Electric Company, Limited by (1) changing the entity designated as "the Company," (2) modifying the Company's address for notices at Section 29.3(a), (3) modifying the Hawaii general excise tax rate at Section 29.24, (4) revising the Company's signature Block and (5) substituting the form of Attachment B (Facility Owned Seller) appropriate to the designated Company entity. For Maui Electric, if the project is located at Maui Electric's Waena site, the PPA will be cross-defaulted to the ground lease. For Hawaii Electric Light, the forms of Attachment N (Acceptance Test General Criteria) and Attachment O (Control System Acceptance Test Criteria) will also be modified, as will the defined terms to the extent necessary to conform to Hawaii Electric Light's Attachments B, N and O.

This document indicates, for information purposes only, the terms and conditions that may be negotiated in a contract for the sale of renewable dispatchable generation to be executed by Hawaiian Electric. The terms and conditions that may be offered by Hawaiian Electric in a renewable dispatchable generation power purchase agreement may be modified to reflect factors such as different renewable technologies, project specifics, changes in applicable rules, guidance from the Public Utilities Commission in proceedings concerning the approval or negotiation of such power purchase agreements, results of an interconnection requirements study and other negotiated terms and conditions.

[NOTE: TEXT WITHIN THIS DOCUMENT THAT APPEARS IN BOLD AND/OR BRACKETS INDICATES A PROVISION THAT MAY REQUIRE REVISION TO CONFORM TO A SPECIFIC PROJECT.]

POWER PURCHASE AGREEMENT FOR RENEWABLE DISPATCHABLE GENERATION

THIS POWER PURCHASE AGREEMENT FOR RENEWABLE DISPATCHABLE GENERATION ("Agreement") is made this ____ day of _____, 20__ (the "Execution Date"), by and between **Hawaiian Electric Company, Inc.**, a Hawai'i corporation (hereinafter called the "Company") and _____ (hereinafter called the "Seller").

WHEREAS, Company is an operating electric public utility on the Island of O'ahu, subject to the Hawai'i Public Utilities Law (Hawai'i Revised Statutes, Chapter 269) and the rules and regulations of the Hawai'i Public Utilities Commission (hereinafter called the "PUC"); and

WHEREAS, the Company System is operated as an independent power grid and must both maximize system reliability for its customers by ensuring that sufficient generation is available and meet the requirements for voltage stability, frequency stability, and reliability standards; and

WHEREAS, Company desires to minimize fluctuations in its purchased energy costs by acquiring renewable dispatchable generation at a fixed Unit Price; and

WHEREAS, Seller desires to build, own, and operate a renewable energy facility that is classified as an eligible resource under Hawai'i's Renewable Portfolio Standards Statute (codified as Hawai'i Revised Statutes (HRS) 269-91 through 269-95); and

WHEREAS, Seller understands the need to use all commercially reasonable efforts to maximize the overall reliability of the Company System; and

WHEREAS, Facility will be located at _____, State of Hawai'i and is more fully described in Attachment A (Description of Generation and Conversion Facility) and Attachment B (Facility Owned by Seller) attached hereto and made a part hereof; and

WHEREAS, Seller desires to sell to Company, and Company agrees to purchase upon the terms and conditions set forth herein, (i) the electric energy generated by the Facility and (ii) the availability, at a fixed Unit Price for the duration of the Initial Term, of the Facility's Net Energy Potential to respond, subject to the Renewable Resource Variability, to Company's dispatch.

NOW, THEREFORE, in consideration of the premises and the respective promises herein, Company and Seller hereby agree as follows:

DEFINITIONS

When the capitalized terms set forth in the Schedule of Defined Terms are used in this Agreement, such terms shall have the meanings set forth in such Schedule.

ARTICLE 1
PARALLEL OPERATION

Company agrees to allow Seller to interconnect and operate the Facility to provide renewable dispatchable generation and energy in parallel with the Company System; provided, however, that such interconnection and operation shall not: (i) adversely affect Company's property or the operations of its customers and customers' property; (ii) present safety hazards to the Company System, Company's property or employees or Company's customers or the customers' property or employees; or (iii) otherwise fail to comply with this Agreement. Such parallel operation shall be contingent upon the satisfactory completion, as determined solely by Company, of the Acceptance Test and, to the extent applicable, the Control System Acceptance Test, in accordance with Good Engineering and Operating Practices.

ARTICLE 2
PURCHASE AND SALE OF ENERGY AND DISPATCHABILITY;
RATE FOR PURCHASE AND SALE; BILLING AND PAYMENT

- 2.1 Purchase and Sale of Electric Energy and Dispatchability of Facility. Subject to the other provisions of this Agreement: (i) Company shall, by an Energy Payment, pay for the Actual Output produced by the Facility and delivered to the Point of Interconnection in response to Company Dispatch of the Facility; and (ii) Company shall, by a Lump Sum Payment, pay for the availability of the Facility's Net Energy Potential to respond, subject to the Renewable Resource Variability, to Company Dispatch in accordance with this Agreement. Included in such purchase and sale of electric energy and such purchase and sale of dispatchability are all of the Environmental Credits associated with the electric energy. Company will not reimburse Seller for any taxes or fees imposed on Seller including, but not limited to, State of Hawai'i general excise tax.
- 2.2 Payment for Electric Energy. Commencing on the Commercial Operations Date, in exchange for the electric energy delivered to the Point of Interconnection in response to Company Dispatch, Seller will be paid an Energy Payment on a monthly basis as provided in Section 1 (Price for Purchase of Electric Energy) of Attachment J (Company Payments for Energy and Dispatchability) to this Agreement.
- 2.3 Lump Sum Payment for Dispatchability. Commencing on the Commercial Operations Date, in exchange for the availability of the Facility's Net Energy Potential to respond, subject to the Renewable Resource Variability, to Company's dispatch in accordance with this Agreement, Company shall pay to Seller a monthly Lump Sum Payment as provided in Section 2 (Lump Sum Payment for Dispatchability) of Attachment J (Company Payments for Energy and Dispatchability) to this Agreement. As more fully set forth in Section 3 (Calculation of Lump Sum Payment) of said Attachment J, the monthly Lump Sum Payment shall be calculated and adjusted to reflect changes in the estimate of the Facility's Net Energy Potential as such estimate is revised from time to time as more fully set forth in Attachment U (Calculation and Adjustment of Net Energy Potential) to this Agreement. For purposes of calculating the monthly Lump Sum Payment to be made to Seller for making the Facility's Net Energy Potential available for Company Dispatch, the monthly Lump

Payment shall be adjusted downward to account for **inverter(s)** that are not available for Company Dispatch because of a Force Majeure condition (i) at the Facility or (ii) that otherwise delays or prevents the Seller from making the **inverter(s)** in question available for Company Dispatch, as more fully set forth in Section 3.iv of Attachment J (Company Payments for Energy and Dispatchability) to this Agreement.

2.4 Assurance of Capability of Facility to Deliver Net Energy Potential.

- (a) Design, Operation and Maintenance to Achieve Availability Benchmark and GPR Benchmark. In order to provide Company with reasonable assurance that, subject to the Renewable Resource Variability, the Facility's Net Energy Potential will be available for Company Dispatch: (i) the Availability Benchmark shall be used to evaluate the availability of the Facility for dispatch by Company and (ii) the GPR Benchmark shall be used to evaluate the efficiency of the Facility. Seller shall design, operate and maintain the Facility in a manner consistent with the standard of care reasonably expected of an experienced owner/operator with the desire and financial resources necessary to design, operate and maintain the Facility to achieve the Availability Benchmark and the GPR Benchmark. The foregoing is without limitation to Seller's other obligations under this Agreement, including the obligation to operate the Facility in accordance with Good Engineering and Operating Practices.
- (b) Acknowledgment of Uncertainties. The Parties acknowledge the inherent uncertainty in the calculation of the Availability Factor and the Measured Performance Ratio. Both Parties hereby assume the risk of such uncertainties and hereby waive any right to dispute:
- (i) the appropriateness of any of the Availability Benchmark, the Availability Factor or the methodology specified in this Agreement for the calculation of the Availability Factor; and
 - (ii) the appropriateness of any of the GPR Benchmark, the Measured Performance Ratio or the methodology specified in this Agreement for the calculation of the Measured Performance Ratio.

2.5 Availability Factor; Liquidated Damages; Termination Rights.

- (a) Calculation of the Availability Factor. Following the end of each LD Period, the Availability Factor shall be calculated for such LD Period as follows:

$$\text{Availability Factor} = 1 - \frac{\text{DownTime} - \text{ExcludedTime}}{\text{TotalTime} - \text{ExcludedTime}}$$

where:

TotalTime is the number of inverters in the Facility multiplied by the total number of seconds in the LD Period.

DownTime is a subset of TotalTime that represents the aggregate of the number of inverter-seconds during the LD Period that one or more inverters are unavailable as indicated by the "inverter available" data point for such inverter sent via SCADA. DownTime is expressed as the total of the Facility's unavailable inverter-seconds (i.e., 1 unavailable inverter for 1 second) during the LD Period.

ExcludedTime is a subset of DownTime that does not "count against" the Seller in calculating the Availability Factor. ExcludedTime is expressed in unavailable inverter seconds and is calculated by multiplying the number of inverters in the Facility that are unavailable by the total number of seconds in the LD Period when such unavailability is the result of any of the following conditions :

- The Facility or a portion of the Facility is unavailable due to Force Majeure.
- The Facility is unavailable due to a Forced Outage resulting from conditions on the Company System other than (i) Seller-Attributable System Conditions or (ii) conditions that the Facility is required to ride-through under Section 3 (Performance Standards) of Attachment B (Facility Owned by Seller).
- The "Plane of Array Irradiance" data point sent via SCADA is less than 50 W/m².

What "counts against" the Seller in calculating the Availability Factor is DownTime minus ExcludedTime.

- (b) Availability Benchmark and Liquidated Damages. For each LD Period, Seller shall achieve an Availability Factor, as calculated as provided in Section 2.5(a) (Calculation of Availability Factor) of this Agreement, of not less than the Availability Benchmark. For avoidance of doubt, because the Availability Factor is calculated over an LD Period of 12 calendar months, the first month for which liquidated damages may be assessed under this Section 2.5(b) (Availability Benchmark and Liquidated

Damages) would be the last calendar month of the initial Contract Year. If the Availability Factor for a LD Period is less than the Availability Benchmark, Seller shall pay, and Company shall accept, as liquidated damages for Seller's failure to achieve the Availability Benchmark for such LD Period, an amount calculated in accordance with the following formula:

<u>Availability Factor</u>	<u>Amount of Liquidated Damages Per Calendar Month</u>
98.9% and below%	For each one-tenth of one percent (0.001) by which the Availability Factor for such LD Period falls below the Availability Benchmark, an amount equal to one-tenth of one percent (0.001) of the Applicable Period Lump Sum Payment for the last calendar month of such LD Period.

For purposes of determining liquidated damages under the preceding formula, the amount by which the Availability Factor for the LD Period in question falls below the applicable threshold shall be rounded to the nearest one-tenth of one percent (0.001). Each Party agrees and acknowledges that (i) the damages that Company would incur if the Seller fails to achieve the Availability Benchmark for a LD Period would be difficult or impossible to calculate with certainty and (ii) the aforesaid liquidated damages are an appropriate approximation of such damages.

- (c) Payment of Liquidated Damages for Failure to Achieve the Availability Benchmark. With respect to the liquidated damages for a calendar month payable under Section 2.5(b) (Availability Benchmark and Liquidated Damages), Company shall have the right, at any time on or after the AF LD Assessment Date for such liquidated damages, at Company's option, to off-set such liquidated damages from the amounts to be paid to Seller under Section 2.3 (Lump Sum Payment for Dispatchability) of this Agreement or to draw such liquidated damages from the Operating Period Security, as follows:

- (i) if the Monthly Report for a given calendar month shows an Availability Factor for the LD Period in question for which liquidated damages are payable under Section 2.5(b) (Availability Benchmark and Liquidated Damages) and Company does not submit a Notice of AF Disagreement with respect to such Monthly Report, the Company shall have the right to off-set or draw the amount of liquidated damages for such calendar month as calculated on the basis of such Availability Factor; and
- (ii) in all cases in which Company submits a Notice of AF Disagreement for a given Monthly Report, Company shall have the right to off-set or draw all or any portion of the amount of liquidated damages for calendar month in question as calculated on the basis of the Availability Factor for the LD Period in question, as shown in such Notice of AF Disagreement; provided, however, that:
 - (aa) if the amount off-set or drawn by the Company exceeds the amount of liquidated damages for such calendar month that are eventually found to be payable pursuant to the Availability Factor for the LD Period in question as determined under either Section 2(c) (Submission of Monthly Report Disagreement to Independent AF Evaluator) or Section 2(h) (Written Decision of Independent AF Evaluator) of Attachment T (Monthly Reporting and Dispute Resolution by Independent AF Evaluator) to this Agreement, Company shall promptly repay such excess to Seller together with, unless the Parties otherwise agree in writing, interest from the date of Company's off-set or draw until the date that such excess is repaid to Seller at the average Prime Rate for such period; and
 - (bb) if Company does not exercise its rights to set-off or draw liquidated damages for such calendar month, or does not set-off or draw the full amount of the liquidated damages for such calendar month that are eventually found to be payable pursuant to the determination of the Availability Factor for the LD Period in

question as determined under either Section 2(c) (Submission of Monthly Report Disagreement to Independent AF Evaluator) or Section 2(h) (Written Decision of Independent AF Evaluator) of Attachment T (Monthly Reporting and Dispute Resolution by Independent AF Evaluator) to this Agreement, Seller shall promptly, upon determination of such Availability Factor as aforesaid, pay to Company the amount of liquidated damages that are found to be owing together with, unless otherwise agreed by the Parties in writing, interest on the amount of such liquidated damages that went unpaid from the AF LD Assessment Date for such liquidated damages until the date such liquidated damages are paid to Company in full at the average Prime Rate for such period, and Company shall have the right, at its option, to off-set such interest for the amounts to be paid to Seller under Section 2.3 (Lump Sum Payment for Dispatchability) of this Agreement or to draw from the Operating Period Security.

Any delay by Company in exercising its rights to off-set liquidated damages and/or interest from the amounts to be paid to Seller under Section 2.3 (Lump Sum Payment for Dispatchability) of this Agreement or to draw such liquidated damages and/or interest from the Operating Period Security shall not constitute a waiver by Company of its right to do so.

- (d) Availability Factor Termination Rights. The Parties acknowledge that, although the intent of the liquidated damages payable under Section 2.5(b) (Availability Benchmark and Liquidated Damages) is to compensate Company for the damages that Company would incur if the Seller fails to achieve the Availability Benchmark for a LD Period, such liquidated damages are not intended to compensate Company for the damages that Company would incur if a pattern of underperformance establishes a reasonable expectation that the Facility is likely to continue to substantially underperform the Availability Benchmark. Accordingly, and without limitation to Company's rights under said Section 2.5(b) (Availability Benchmark and Liquidated Damages) for those LD Periods

during which the Seller failed to achieve the Availability Benchmark, the failure of the Facility to achieve an Availability Factor of not less than **84%** for each of three consecutive Contract Years shall constitute an Event of Default under Section 15.1(b) of this Agreement for which Company shall have the rights (including but not limited to the termination rights) set forth in Article 15 (Event of Default) and Article 16 (Damages in the Event of Termination by Company).

2.6 Measured Performance Ratio; Liquidated Damages; Termination Rights.

(a) Calculation of Measured Performance Ratio ("MPR").

- (i) The Measured Performance Ratio ("MPR") represents the Facility's measured AC power output compared to its theoretical DC power output under the standard test conditions of 1000 W/m² and 25°C, as adjusted for the plane of array irradiance conditions measured at the Site.
- (ii) Following the end of each LD Period, the Measured Performance Ratio shall be calculated for such LD Period (using the previous 12 months of 2-second data provided via SCADA) as follows:

$$MPR = \frac{\sum_i P_{AC,i}}{\sum_i \left[P_{DCSTC} \left(\frac{G_{POA_i}}{G_{STC}} \right) \right]}$$

Where:

i = each 15 minute interval where the measured plane of array irradiance exceeds 600W/m²

P_{AC} is the measured AC power output of the Facility averaged over time period *i* (MW)

G_{STC} = plane of array irradiance at the standard condition of 1000 W/m²

P_{DCSTC} is the DC rated capacity of the Facility at the standard test conditions of 1000 W/m² and 25°C (MW), (i.e. the DC power rating of the PV panels at standard test conditions multiplied by the number of panels in the Facility);

G_{POA} is the measured plane of array irradiance averaged over time period *i* (W/m²);

- (iii) The data used in the foregoing calculation shall be filtered by including only periods in which, for the entire 15-minute interval, both the plane

of array irradiance is not less than 600 W/m² and the Facility is in unconstrained operations. The aforementioned 15-minute intervals are fixed intervals that commence, in sequence, at the top of each hour and at 15, 30 and 45 minutes past the hour.

- (iv) The Measured Performance Ratio shall be calculated for the set of filtered SCADA data points available for the applicable LD Period. The result of the foregoing calculation for the entire LD Period shall be the Measured Performance Ratio (MPR) for such LD Period.

(b) Determination of GPR Benchmark.

- (i) Upon Commencement of Commercial Operations. If a copy of the IE Energy Assessment Report together with the weather profile relied upon in arriving at the NEP IE Estimate is not provided to Company, the GPR Benchmark for the period commencing on the Commercial Operations Date through the end of the calendar month during which the Initial OEPR is issued shall be **0.9**. If a copy of the IE Energy Assessment Report together with the supporting data (plane of array irradiance and corresponding power output) relied upon in arriving at the NEP IE Estimate is provided to Company, the GPR Benchmark shall be calculated using such supporting data and the Measured Performance Ratio formula in Section 2.6(a)(ii) of this Agreement. Within 30 Days of Company's receipt of the IE Energy Assessment Report together with the aforementioned supporting data, Company shall provide written notice to Seller of either (aa) the GPR Benchmark derived from such supporting data or (bb) Company's inability to reasonably derive a GPR Benchmark from such supporting data, in which case the GPR Benchmark shall be **0.9**.
- (ii) Commencing With Initial OEPR. For the period commencing with the first Day of the calendar month following the issuance of the Initial OEPR through the end of the calendar month during which the first Subsequent OEPR is issued, the GPR Benchmark shall be calculated using the supporting data (plane of array irradiance and corresponding power

output)relied upon in arriving at the Initial OEPR's NEP OEPR Estimate and the Measured Performance Ratio formula in Section 2.6(a)(ii) of this Agreement. Within 30 Days of Company's receipt of the Initial OEPR together with the aforementioned supporting data, Company shall either (i) provide written notice to Seller of the GPR Benchmark derived as aforesaid or (ii) if Company is unable to reasonably derive a GPR Benchmark as aforesaid, deliver a written request to the OEPR Evaluator (with a copy to Seller) that such OEPR Evaluator issue, within 30 Days, a written clarification of the Initial OEPR specifying the GPR Benchmark. If such request for clarification is made to the OEPR Evaluator, within 10 Business Days following the expiration of the 30-Day period provided for receipt of such OEPR Evaluator's reply, Company shall provide written notice to Seller of either (i) the GPR Benchmark derived from such written clarification by the OEPR Evaluator or (ii) the designation of **0.9** as the GPR Benchmark due to either the failure of the OEPR Evaluator to issue a written clarification or, if a written clarification was issued, the inability of Company to reasonably derive a GPR Benchmark on the basis of such written clarification.

- (iii) Commencing With the First Subsequent OEPR and Thereafter. Commencing with the issuance of the first Subsequent OEPR, for each period commencing with the first Day of the calendar month following the issuance of a Subsequent OEPR (including but not limited to the first Subsequent OEPR) through the end of the calendar month during which the next Subsequent OEPR is issued, the GPR Benchmark shall be calculated using the supporting data (plane of array irradiance and corresponding power output) relied upon in arriving at the NEP OEPR Estimate of the most recent Subsequent OEPR and the Measured Performance Ratio formula in Section 2.6(a)(ii) of this Agreement. Within 30 Days of Company's receipt of each Subsequent OEPR, Company shall either (i) provide written notice to Seller of the GPR Benchmark derived as aforesaid or (ii) if Company is unable to reasonably derive a GPR Benchmark as aforesaid, deliver a written request

to the OEPR Evaluator (with a copy to Seller) that such OEPR Evaluator issue, within 30 Days, a written clarification of such Subsequent OEPR specifying the GPR Benchmark. If such request for clarification is made to the OEPR Evaluator, within 10 Business Days following the expiration of the 30-Day period provided for the receipt of such OEPR Evaluator reply, Company shall provide written notice to Seller of either (i) the GPR Benchmark derived from such written clarification by the OEPR Evaluator or (ii) the designation of **0.9** as the GPR Benchmark due to either the failure of the OEPR Evaluator to issue a written clarification or, if a written clarification was issued, the inability of Company to reasonably derive a GPR Benchmark on the basis of such written clarification.

(iv) Disagreement Over Determination of GPR Benchmark. Any disagreement over the determination of the GPR Benchmark shall be resolved as set forth in Section 2 (Disagreements Concerning Availability Factor, GPR Benchmark and Measured Production Ratio) of Attachment T (Monthly Reporting and Dispute Resolution by Independent AF Evaluator) to this Agreement.

(c) GPR Benchmark and Liquidated Damages. For each LD Period, Seller shall achieve a Measured Performance Ratio, as calculated as provided in Section 2.6(a) (Calculation of Measured Performance Ratio) of this Agreement, of not less than 95% the GPR Benchmark as adjusted by the degradation factor set forth below. For avoidance of doubt, because the Measured Performance Ratio is calculated over an LD Period of 12 calendar months, the first month for which liquidated damages may be assessed under this Section 2.6(c) (GPR Benchmark and Liquidated Damages) would be the last calendar month of the initial Contract Year. If the Measured Performance Ratio for a LD Period is less than 95% the GPR Benchmark as adjusted by the degradation factor set forth below, Seller shall pay, and Company shall accept, as liquidated damages for Seller's failure to achieve the GPR Benchmark for such LD Period, an amount calculated in accordance with the following formula:

Measured Amount of Liquidated Damages Per

<u>Performance Ratio</u>	<u>Calendar Month</u>
Within the bandwidth (the "<u>Tier 1 Bandwidth</u>") of (i) 0.001 less than $GPR Benchmark * DF * 0.95$ and (ii) $GPR Benchmark * DF * 0.9$	For each one-tenth of one percent (0.001) by which the Measured Performance Ratio for such LD Period falls within the bandwidth specified in this subparagraph, an amount equal to one-tenth of one percent (0.001) of the Applicable Period Lump Sum Payment for the last calendar month of such LD Period. The upper end of the aforementioned bandwidth consists of and includes the product, less 0.001, of the GPR Benchmark, the applicable degradation factor (DF), and 95%. The lower end of the aforementioned bandwidth consists of and includes the product of the GPR Benchmark, the applicable degradation factor (DF), and 90%; plus
Within the bandwidth (the "<u>Tier 2 Bandwidth</u>") of (i) 0.001 less than $GPR Benchmark * DF * 0.9$ and (ii) $GPR Benchmark * DF * 0.8$	For each one-tenth of one percent (0.001) by which the Measured Performance Ratio for such LD Period falls within the bandwidth specified in this subparagraph, an amount equal to two-tenths of one percent (0.002) of the Applicable Period Lump Sum Payment for the last calendar month of such LD Period. The upper end of the aforementioned bandwidth consists of and includes the product, less 0.001, of the GPR Benchmark, the applicable degradation factor (DF), and 90%. The lower end of the aforementioned bandwidth consists of and includes the product of the GPR Benchmark, the applicable degradation factor (DF), and 80%. plus
0.001 less than $GPR Benchmark * DF * 0.8$ and below	For each one-tenth of one percent (0.001) by which the Measured Performance Ratio for such LD Period falls below the product, less 0.001, of the GPR Benchmark, the applicable degradation factor (DF), and 80%, an

amount equal to four-tenths of one percent (0.004) of the Applicable Period Lump Sum Payment the last calendar month of such LD Period.

For purposes of the foregoing calculations under this Section 2.6(c) (GPR Benchmark and Liquidated Damages), the degradation factor (DF) is calculated for each Contract Year (e.g., second Contract Year, third Contract Year, fourth Contract Year, etc.) as follows: $DF = 0.994^{(\text{Applicable Contract Year} - 1)}$. For purposes of the foregoing formula, the "Applicable Contract Year" is the Contract Year within which the calendar month in question falls. If all of the months of an LD Period fall within the same Contract Year, that Contract Year is the "Applicable Contract Year." For example, if all of the months of an LD Period fall within the third Contract Year, the value assigned to the "Applicable Contract Year" would be "3" and the formula for calculating the DF for such LD Period would be: $DF = 0.994^{(3-1)}$. However, because the LD Period is a rolling 12-month period, the LD Period will often straddle two consecutive Contract Years. In such cases, all of the months falling within the same Contract Year will be assigned the value for such Contract Year and the value assigned to the "Applicable Contract Year" for purposes of the foregoing formula shall be the average of the assigned monthly values for such 12-month LD Period. For example, for an LD Period which has four months in the third Contract Year and eight months in the fourth Contract Year, the value assigned to the "Applicable Contract Year" for such LD Period would be 3.66, as calculated as follows:

$$\frac{(3 \times 4) + (4 \times 8)}{12}$$

and the formula for calculating the DF for such LD Period would be $DF = 0.994^{(3.66 - 1)}$. For purposes of determining liquidated damages under this Section 2.6(c) (GPR Benchmark and Liquidated Damages), the amount by which the Measured Performance Ratio for the LD Period in question falls below the applicable threshold shall be rounded to the nearest one-tenth of one percent (0.001). Each Party agrees and acknowledges that (i) the damages that Company would incur if the Seller fails to

achieve the GPR Benchmark for a LD Period would be difficult or impossible to calculate with certainty and (ii) the aforesaid liquidated damages are an appropriate approximation of such damages.

(d) Payment of Liquidated Damages for Failure to Achieve the GPR Benchmark. With respect to the liquidated damages for a calendar month payable under Section 2.6(c) (GPR Benchmark and Liquidated Damages), Company shall have the right, at any time on or after the MPR LD Assessment Date for such liquidated damages, at Company's option, to off-set such liquidated damages from the amounts to be paid to Seller under Section 2.3 (Lump Sum Payment for Dispatchability) of this Agreement or to draw such liquidated damages from the Operating Period Security, as follows:

(i) if the Monthly Report for a given calendar month shows a Measured Performance Ratio for the LD Period in question for which liquidated damages are payable under Section 2.6(c) (GPR Benchmark and Liquidated Damages) and Company does not submit a Notice of MPR Disagreement with respect to such Monthly Report, the Company shall have the right to off-set or draw the amount of liquidated damages for such calendar month as calculated on the basis of such Measured Performance Ratio; and

(ii) in all cases in which Company submits a Notice of MPR Disagreement for a given Monthly Report, Company shall have the right to off-set or draw all or any portion of the amount of liquidated damages for calendar month in question as calculated on the basis of the Measured Performance Ratio for the LD Period in question, as shown in such Notice of MPR Disagreement; provided, however, that:

(aa) if the amount off-set or drawn by the Company exceeds the amount of liquidated damages for such calendar month that are eventually found to be payable pursuant to the Measured Performance Ratio for the LD Period in question as determined under either Section 2(c) (Submission of Monthly Report Disagreement to Independent AF Evaluator) or Section 2(h) (Written Decision of Independent

AF Evaluator) of Attachment T (Monthly Reporting and Dispute Resolution by Independent AF Evaluator) to this Agreement, Company shall promptly repay such excess to Seller together with, unless the Parties otherwise agree in writing, interest from the date of Company's off-set or draw until the date that such excess is repaid to Seller at the average Prime Rate for such period; and

- (bb) if Company does not exercise its rights to set-off or draw liquidated damages for such calendar month, or does not set-off or draw the full amount of the liquidated damages for such calendar month that are eventually found to be payable pursuant to the determination of the Measured Performance Ratio for the LD Period in question as determined under either Section 2(c) (Submission of Monthly Report Disagreement to Independent AF Evaluator) or Section 2(h) (Written Decision of Independent AF Evaluator) of Attachment T (Monthly Reporting and Dispute Resolution by Independent AF Evaluator) to this Agreement, Seller shall promptly, upon determination of such Measured Performance Ratio as aforesaid, pay to Company the amount of liquidated damages that are found to be owing together with, unless otherwise agreed by the Parties in writing, interest on the amount of such liquidated damages that went unpaid from the MPR LD Assessment Date for such liquidated damages until the date such liquidated damages are paid to Company in full at the average Prime Rate for such period, and Company shall have the right, at its option, to off-set such interest for the amounts to be paid to Seller under Section 2.3 (Lump Sum Payment for Dispatchability) of this Agreement or to draw from the Operating Period Security.

Any delay by Company in exercising its rights to off-set liquidated damages and/or interest from the amounts to be paid to Seller under Section 2.3 (Lump Sum Payment for Dispatchability) of this Agreement or to draw such liquidated damages and/or interest from the Operating

Period Security shall not constitute a waiver by Company of its right to do so.

- (e) MPR Termination Rights. The Parties acknowledge that, although the intent of the liquidated damages payable under Section 2.6(c) (GPR Benchmark and Liquidated Damages) is to compensate Company for the damages that Company would incur if the Seller fails to achieve the GPR Benchmark for a LD Period, such liquidated damages are not intended to compensate Company for the damages that Company would incur if a pattern of underperformance establishes a reasonable expectation that the Facility is likely to continue to substantially underperform the GPR Benchmark. Accordingly, and without limitation to Company's rights under said Section 2.6(c) (GPR Benchmark and Liquidated Damages) for those LD Periods during which the Seller failed to achieve the GPR Benchmark, the failure of the Facility to achieve, for each of three consecutive Contract Years, a Measured Performance Ratio of not less than the Tier 2 Bandwidth for such Contract Year shall constitute an Event of Default under Section 15.1(c) of this Agreement for which Company shall have the rights (including but not limited to the termination rights) set forth in Article 15 (Events of Default) and Article 16 (Damages in the Event of Termination by Company).
- 2.7 No Payments Prior to Commercial Operations Date. Prior to the Commercial Operations Date, Company shall not be obligated to accept or pay for any electric energy delivered by Seller. Company shall not, and shall not be obligated to, make any payment for the availability of the Facility prior to the Commercial Operations Date.
- 2.8 Sales of Electric Energy By Company to Seller. Sales of electric energy by Company to Seller shall be governed by an applicable rate schedule filed with the PUC and not by this Agreement, except with respect to the reactive amount adjustment (if any) referred to in Attachment B (Facility Owned by Seller).
- 2.9 Company's Obligation to Provide Certain Data. By the fifth (5th) Business Day of each calendar month, Company shall provide Seller or its designated agent with the appropriate data for Seller to compute the amount to be paid for the electric energy purchased by Company in the preceding

calendar month as determined in accordance with this Agreement.

- 2.10 Seller's Preparation of the Monthly Invoice. By the tenth (10th) Business Day of each calendar month, Seller shall submit to Company an invoice that separately states the following for the preceding month: (i) the Actual Output during this period; (ii) the charge for electric energy purchased by Company, as set forth in Attachment J (Company Payments for Energy and Dispatchability) of this Agreement; (iii) the monthly Lump Sum Payment for this period; and (iv) the monthly metering charge as set forth in Article 7 (Seller Payments) of this Agreement.
- 2.11 Payment Procedures. By the twentieth (20th) Business Day of each calendar month (but, except as otherwise provided in the following sentence, no later than the last Business Day of that month if there are less than twenty Business Days in that month), Company shall, subject to Company's right to off-set liquidated damages as provided in Section 2.5(c) (Payment of Liquidated Damages for Failure to Achieve the Availability Benchmark) and Section 2.6(d) (Payment of Liquidated Damages for Failure to Achieve the GPR Benchmark) of this Agreement, make payment on such invoice, or provide to Seller an itemized statement of its objections to all or any portion of such invoice and pay any undisputed amount. Notwithstanding the foregoing, the Day by which the Company shall make payment to Seller hereunder shall be increased by one (1) day for each Day that Seller is delinquent in providing to the Company either: (i) the Monthly Report for the calendar month in question pursuant to Section 1 (Monthly Report) of Attachment T (Monthly Reporting and Dispute Resolution by Independent AF Evaluator) to this Agreement; or (ii) the information required under Section 2.10 (Seller's Preparation of the Monthly Invoice) of this Agreement. However, if Company is not timely in providing data required in Section 2.9 (Company's Obligation to Provide Certain Data) and this directly causes Seller to be unable to deliver its invoice in accordance with the time frame set forth in Section 2.10 (Seller's Preparation of the Monthly Invoice), then Company shall still meet the twentieth (20th) Business Day payment date. If Seller is unable to provide a complete invoice for the reasons set forth in the preceding sentence, an estimated payment, subject to reconciliation with the complete invoice, may be made by Company as an interim provision until a complete invoice can be prepared by Seller and received by Company.

- 2.12 Late Payments. Notwithstanding all or any portion of such invoice in dispute, and subject to the provisions of Section 2.5 (c) (ii) and Section 2.6(d) (ii) of this Agreement (to the extent applicable), interest shall accrue on any invoiced amount that remains unpaid following the twentieth (20th) Business Day of each calendar month (or the last Business Day of that month if there are less than twenty Business Days in that month), or following the due date for such payment if extended pursuant to Section 2.11 (Payment Procedures), at the average daily Prime Rate for the period commencing on the Day following the Day such payment is due until the invoiced amounts (or amounts due to Seller if determined to be less than the invoiced amounts) are paid in full. Partial payments shall be applied first to outstanding interest and then to outstanding invoice amounts.
- 2.13 Adjustments to Invoices After Payment. In the event adjustments are required to correct inaccuracies in an invoice after payment, the Party requesting adjustment shall recompute and include in the Party's request the principal amounts due during the period of the inaccuracy together with the amount of interest from the date that such invoice was payable until the date that such recomputed amount is paid at the average daily Prime Rate for the period. The difference between the amount paid and that recomputed for the invoice, along with the allowable amount of interest, shall either be (i) paid to Seller or set-off by Company, as appropriate, in the next invoice payment to Seller, or (ii) objected to by the Party responsible for such payment within thirty (30) Days following its receipt of such request. If the Party responsible for such payment objects to the request, then the Parties shall work together in good faith to resolve the objection. If the Parties are unable to resolve the objection, the matter shall, except to the extent otherwise provided in Section 28.3 (Exclusions), be resolved pursuant to Article 28 (Dispute Resolution). All claims for adjustments shall be waived for any amounts that were paid or should have been payable more than thirty-six (36) months preceding the date of receipt of any such request.
- 2.14 Company's Billing Records. Seller, after giving reasonable advance written notice to Company, shall have the right to review all billing, metering and related records necessary to verify the accuracy of the data provided by Company pursuant to Section 2.9 (Company's Obligation to Provide

Certain Data) and payments relating to the Facility during Company's normal working hours on Business Days. Company shall maintain such records for a period of not less than thirty-six (36) months.

ARTICLE 3
FACILITY OWNED AND/OR OPERATED BY SELLER

- 3.1 The Facility. Seller agrees to furnish, install, operate, and maintain the Facility in accordance with the provisions of this Agreement, including, without limitation, the operating procedures and performance standards as more fully described in Attachment B (Facility Owned by Seller) and Attachment C (Methods and Formulas for Measuring Performance Standards). After the Commercial Operations Date, Seller agrees that no changes or additions to the Facility shall be made without prior written approval by Company and amendment to the Agreement unless such changes or additions to the Facility could not reasonably be expected to have a material effect on the assumptions used in performing the IRS.
- 3.2 Allowed Capacity. The net instantaneous MW output from Facility may not exceed the Allowed Capacity. Company may take appropriate action to limit the Actual Output pursuant to, but not limited to, Article 8 (Company Dispatch) Article 9 (Personnel and System Safety), Article 25 (Good Engineering and Operating Practices), and Attachment B (Facility Owned by Seller).
- 3.3 Point of Interconnection. The Point of Interconnection is shown on Attachment E (Single-Line Drawing and Interface Block Diagram), as provided in Section 1(a)(i) (Single-Line Drawing, Interface Block Diagram, Relay List, Relay Settings and Trip Scheme) of Attachment B (Facility Owned by Seller). The Point of Interconnection will be at the voltage level of the Company System. If it is necessary to step up the voltage at which Seller's electric energy is delivered to Company System, the Point of Interconnection will be on the high voltage side of the step-up transformer.
- 3.4 Renewable Portfolio Standards.
- (a) Renewable Portfolio Standards. If, as a result of any RPS Amendment, the electric energy delivered from the Facility should no longer qualify as "renewable electrical energy," Seller shall, at the request of Company, develop and recommend to Company within a reasonable period of time following Company's request, but in no event more than 90 Days after Seller's receipt of such request (or such other period of time as Company and Seller may agree in writing) reasonable measures to cause the electric energy delivered from

the Facility to come within such revised definition of "renewable electrical energy" ("Seller's RPS Modifications Proposal").

- (b) Seller's RPS Modifications Proposal. Upon receipt of Seller's RPS Modifications Proposal, Company will evaluate Seller's RPS Modifications Proposal. Seller shall assist Company in performing such evaluation as and to the extent reasonably requested by Company (including, but not limited to, providing such additional information as Company may reasonably request and participating in meetings with Company as Company may reasonably request).
- (c) RPS Modifications Document. If, following Company's evaluation of Seller's RPS Modifications Proposal, Company desires to consider the implementation by Seller of the changes recommended in Seller's RPS Modifications Proposal, Company shall provide Seller with written notice to that effect, such notice to be issued to Seller within 180 Days of receipt of Seller's RPS Modifications Proposal, and Company and Seller shall proceed to negotiate in good faith a document setting forth the specific changes to the Agreement that are necessary to implement such RPS Modifications Proposal (the "RPS Modifications Document"). A decision by Company to initiate negotiations with Seller as aforesaid shall not constitute an acceptance by Company of any of the details set forth in Seller's RPS Modifications Proposal, including but not limited to the RPS Modifications and the RPS Pricing Impact. Any adjustment to the Contract Pricing pursuant to such RPS Modifications Document shall be limited to the RPS Pricing Impact. The time periods set forth in such RPS Modifications Document as to the effective date for the RPS Modifications shall be measured from the date the PUC Order with respect to such RPS Modifications becomes non-appealable as provided in Section 3.4(e) (PUC RPS Order).
- (d) Failure to Reach Agreement. If Company and Seller are unable to agree upon and execute a RPS Modifications Document within 180 Days of Company's written notice to Seller pursuant to Section 3.4(c) (RPS Modifications Document), Company shall have the option of declaring the failure to reach agreement on and

execute such Document to be a dispute and submit such dispute to an Independent Evaluator for the conduct of a determination pursuant to Section 3.4(h) (Dispute) of this Agreement. Any decision of the Independent Evaluator, rendered as a result of such dispute shall include a form of a RPS Modifications Document as described in Section 3.4(c) (RPS Modifications Document).

- (e) PUC RPS Order. No RPS Modifications Document shall constitute an amendment to the Agreement unless and until a PUC RPS Order issued with respect to such Document has become non-appealable. Once the condition of the preceding sentence has been satisfied, such RPS Modifications Document shall constitute an amendment to this Agreement. To be "non-appealable" under this Section 3.4(e) (PUC RPS Order), such PUC RPS Order shall be either (i) not subject to appeal to any Circuit Court of the State of Hawai'i or the Supreme Court of the State of Hawai'i, because the thirty (30) Day period (accounting for weekends and holidays as appropriate) permitted for such an appeal has passed without the filing of notice of such an appeal, or (ii) affirmed on appeal to any Circuit Court of the State of Hawai'i or the Supreme Court, or the Intermediate Appellate Court upon assignment by the Supreme Court, of the State of Hawai'i, or affirmed upon further appeal or appellate process, and is not subject to further appeal, because the jurisdictional time permitted for such an appeal (and/or further appellate process such as a motion for reconsideration or an application for writ of certiorari) has passed without the filing of notice of such an appeal (or the filing for further appellate process).
- (f) Company's Rights. The rights granted to Company under Section 3.4(C) (RPS Modifications Document) and Section 3.4(D) (Failure to Reach Agreement) above are exclusive to Company. Seller shall not have a right to initiate negotiations of a RPS Modifications Document or to initiate dispute resolution under Section 3.4(H) (Dispute), as a result of a failure to agree upon and execute any RPS Modifications Document.
- (g) Limited Purpose. This Section 3.4 (Renewable Portfolio Standards) is intended to specifically

address the implementation of reasonable measures to cause the electric energy delivered from the Facility to come within the revised definition of "renewable electrical energy" under any RPS Amendment and is not intended for either Party to provide a means for renegotiating any other terms of this Agreement. Revisions to this Agreement in accordance with the provisions of this Section 3.4 (Renewable Portfolio Standards) are not intended to increase Seller's risk of non-performance or default.

- (h) Dispute. If Company decides to declare a dispute as a result of the failure to reach agreement and execute a RPS Modifications Document pursuant to Section 3.4(D) (Failure to Reach Agreement), it shall provide written notice to that effect to Seller. Within 20 Days of delivery of such notice Seller and Company shall agree upon an Independent Evaluator to resolve the dispute regarding a RPS Modifications Document. The Independent Evaluator shall be reasonably qualified and expert in renewable energy power generation, matters relating to the Performance Standards, financing, and power purchase agreements. If the Parties are unable to agree upon an Independent Evaluator within such 20-Day period, Company shall apply to the PUC for the appointment of an Independent Evaluator. If an Independent Observer retained under the Competitive Bidding Framework is qualified and willing and available to serve as Independent Evaluator, the PUC shall appoint one of the persons or entities qualified to serve as an Independent Observer to be the Independent Evaluator; if not, the PUC shall appoint another qualified person or entity to serve as Independent Evaluator. In its application, Company shall ask the PUC to appoint an Independent Evaluator within 30 Days of the application.
- (1) Promptly upon appointment, the Independent Evaluator shall request the Parties to address the following matters within the next 15 Days:
- (a) The reasonable measures required to be taken by Seller to cause the electric energy delivered from the Facility to come within such revised definition of "renewable electrical energy" under the RPS Amendment in question;

- (b) How Seller would implement such measures;
 - (c) Reasonably expected net costs and/or lost revenues associated with such measures so the energy delivered by the Facility complies with such revised definition of "renewable electrical energy under the RPS Amendment in question;
 - (d) The appropriate level, if any, of RPS Pricing Impact in light of the foregoing; and
 - (e) Contractual consequences for non-performance that are commercially reasonable under the circumstances.
- (2) Within 90 Days of appointment, the Independent Evaluator shall render a decision unless the Independent Evaluator determines it needs to have additional time, not to exceed 45 Days, to render a decision.
- (3) The Parties shall assist the Independent Evaluator throughout the process of preparing its review, including making key personnel and records available to the Independent Evaluator, but neither Party shall be entitled to participate in any meetings with personnel of the other Party or review of the other Party's records. However, the Independent Evaluator will have the right to conduct meetings, hearings or oral arguments in which both Parties are represented. The Parties may meet with each other during the review process to explore means of resolving the matter on mutually acceptable terms.
- (4) The following standards shall be applied by the Independent Evaluator in rendering his or her decision: (i) if it is not technically or operationally feasible for Seller to implement reasonable measures required to cause the electric energy delivered from the Facility to come within such revised definition of "renewable electrical energy" under the RPS Amendment in question, the Independent Evaluator shall determine that the Agreement shall not be amended to comply with such changes in RPS (unless the Parties agree

otherwise); (ii) if it is technically or operationally feasible for Seller to implement reasonable measures required to cause the electric energy delivered from the Facility to come within such revised definition of "renewable electrical energy" under RPS, the Independent Evaluator shall incorporate such required changes into a RPS Modifications Document including (aa) Seller's RPS Modifications, (bb) pricing terms that incorporate the RPS Pricing Impact, and (cc) contract terms and conditions that are commercially reasonable under the circumstances, especially with respect to the consequences of non-performance by Seller as to the RPS Modifications. In addition to the RPS Modifications Document, the Independent Evaluator shall render a decision which sets forth the positions of the Parties and Independent Evaluator's rationale for his or her decisions on disputed issues.

- (5) The fees and costs of the Independent Evaluator shall be paid by Company up to the first \$30,000 of such fees and costs; above those amounts, the Party that is not the prevailing Party shall be responsible for any such fees and costs; provided, if neither Party is the prevailing Party, then the fees and costs of the Independent Evaluator above \$30,000, shall be borne equally by the Parties. The Independent Evaluator in rendering his or her decision shall also state which Party prevailed over the other Party, or that neither Party prevailed over the other.

ARTICLE 4
COMPANY-OWNED INTERCONNECTION FACILITIES

The terms and conditions related to the Company-Owned Interconnection Facilities are set forth in Attachment G (Company-Owned Interconnection Facilities) of this Agreement. In accordance with Section 8 (Transfer of Ownership/Title) of Attachment G (Company-Owned Interconnection Facilities), on the Transfer Date, Seller shall convey title to the Company-Owned Interconnection Facilities that were designed and constructed by or on behalf of Seller by executing a Bill of Sale and Assignment document substantially in the form set forth in Attachment H (Form of Bill of Sale and Assignment). In addition, in accordance with Section 8 (Transfer of Ownership/Title) of Attachment G (Company-Owned Interconnection Facilities) on the Transfer Date, Seller shall deliver to Company any and all executed documents required to assign all leases with respect to the Company-Owned Interconnection Facilities to Company, which documents shall be substantially in the form set forth in Attachment I (Form of Assignment of Lease and Assumption).

ARTICLE 5
MAINTENANCE RECORDS AND SCHEDULING

5.1 Operating Records.

- (a) Seller's Logs. Seller shall maintain, at least daily, a log in which it shall record all pertinent data that will indicate whether the Facility is being operated in accordance with Good Engineering and Operating Practices. These data logs shall include, but not be limited to, all maintenance and inspection work performed at the Facility, circuit breaker trip operations, relay operations including target indications, megavar and megawatt recording charts (and/or equivalent computer records), all unusual conditions experienced or observed and any reduced capability and the reasons therefor and duration thereof. For each inverter generator, the data reported shall include planned derated hours, unplanned derated hours, average derated kW during the derated hours, scheduled maintenance hours, average derated kW during scheduled maintenance hours, the number of turbine starts, hours on-control and hours on-line.
- (b) Company Access to Seller's Logs. Seller shall provide Company access to Seller's records which identify the priority, as internally assigned by Seller, of specific preventive or corrective maintenance activities. These records shall include items for which Seller has deferred the inspection or corrective action to a future scheduled plant outage. In addition, Seller shall provide copies of all written correspondence between Seller and the Facility Lender and Seller and the insurance underwriters for the Facility equipment pertaining to maintenance practices, procedures and scheduling (including deferral) of maintenance at the Facility.
- (c) Time Period for Maintaining Records. Any and all records, correspondence, memoranda and other documents or electronically recorded data related to the fueling, operation and maintenance of the Facility shall be maintained by Seller for a period of not less than six (6) years. Company shall have the right to review and copy any such items upon request.

5.2 Maintenance Records.

- (a) Seller's Summary of Maintenance and Inspection Performed. Prior to February 1 of each calendar year, Seller shall submit to Company for inspection at the Site, a summary in a format similar to the example provided in Attachment V (Summary of Maintenance and Inspection Performed in Prior Calendar Year) of all maintenance and inspection work performed in the prior calendar year, and of all conditions experienced or observed during such calendar year that may have a material adverse effect on or may materially impair the short-term or long-term operation of the Facility at the operational levels contemplated by this Agreement. The summary shall present the requested data in a meaningful and informative manner consistent with the cooperative exchange of information between the Parties. If available and practicable, such summary shall be provided in electronic format with sufficient software so that Company can group activities for specific process areas of the Facility and be able to view the maintenance history of a specific equipment item. Such summary shall also include Seller's proposals for correcting or preventing recurrences of identified equipment problems and for performing such other maintenance and inspection work as is required by Good Engineering and Operating Practices.
- (b) Company's Written Recommendations. Within sixty (60) Days of receiving such summary, and after any reasonable inspection desired by Company of the Facility and consultation with Seller, Company may provide written recommendations for specific operation or maintenance actions or for changes in the operation or maintenance program of the Facility. Company's making or failing to make recommendations with respect to operation and maintenance of the Facility shall not be construed as endorsing the operation and maintenance thereof or as any warranty of the safety, durability or reliability of the Facility nor as a waiver of any Company right. If Seller agrees with Company, Seller shall, within a reasonable time after Company makes such recommendations, not to exceed ninety (90) Days, implement Company's recommendations. If Seller disagrees with Company, it shall within ten (10) days inform Company of alternatives it will take

to accomplish the same intent, or provide Company with a reasonable explanation as to why no action is required by Good Engineering and Operating Practices. If Company disagrees with Seller's position, and if, for each of the three preceding Contract Years, the Availability Factor was less than **94%** and/or the MPR was less than the Tier 1 Bandwidth for such Contract Year, then the parties shall commission a study by a Qualified Independent Consultant chosen from the Qualified Independent Consultant List set forth in Attachment U (Consultant List) to this Agreement and the Qualified Independent Consultant will make a recommendation to remedy the situation. Seller shall abide by the Qualified Independent Consultant's recommendation contained in such study. Both Parties shall equally share in the cost for the Qualified Independent Consultant. However, Seller shall pay all costs associated with implementing the recommendation contained in the Independent Consultant's report.

- 5.3 Seller's Quarterly Maintenance Schedule: By each March 1st, June 1st, September 1st and December 1st (as applicable, subsequent to the Commercial Operations Date), Seller shall provide to Company in writing a projection of maintenance outages and reductions in capacity for the next calendar quarter, including the estimated MW that is anticipated to be off-line for each projected maintenance event. Seller shall provide Company with prompt written notice of any deviation from its quarterly maintenance schedule but in any case Seller shall provide such written notice not less than one week prior to commencing any such rescheduled maintenance event. During any scheduled or rescheduled maintenance event, Seller will provide an update each Day to Company's operating personnel regarding the status of such maintenance.
- 5.4 Seller's Annual Maintenance Schedule: In addition, Seller shall submit to Company a written schedule of maintenance outages which will reduce the capacity of the Facility by **[five (5) MW] [more than 25% of the Allowed Capacity]** or more for the next two-year period, beginning with January of the following year, in writing to Company each year by June 30. The schedule shall state the proposed dates and durations of scheduled maintenance, including the scope of work for the maintenance requiring shutdown or reduction in output of the Facility and the estimated MW that is anticipated to be off-line for each projected maintenance

event. Company shall review the maintenance schedule for the two-year period and inform Seller in writing no later than December 1 of the same year of Company's concurrence or requested revisions; provided, however, that Seller shall not be required to agree to any proposed revisions that, in Seller's judgment, will void or violate any warranties of equipment that is part of, or used in connection with, the Facility or violate any long-term service agreement with respect to such equipment, in which case Seller shall promptly notify Company thereof, and Seller and Company shall endeavor to reach a mutually satisfactory resolution of the matter in question. With respect to such agreed upon revisions, Seller shall revise its schedule for timing and duration of scheduled shutdowns and scheduled reductions of output of the Facility to accommodate Company's revisions, unless such revisions would not be consistent with Good Engineering and Operating Practices, and make all commercially reasonable efforts, consistent with Good Engineering and Operating Practices, to accommodate any subsequent changes in such schedule reasonably requested by Company.

- 5.5 Seller's Notification Obligations. When Seller learns that any of its equipment will be removed from or returned to service, and any such removal or return may affect the ability of the Facility to deliver electric energy to Company, Seller shall notify Company as soon as practicable. This requirement to notify shall include, but not be limited to, notice to Company of Seller's intention to shut down any solar photovoltaic generator plus inverter unit. Any unit shut-down shall be coordinated with Company in advance to the extent practicable to allow a reasonable amount of time for Company to make generation adjustments required by the loss of availability from a unit shut-down.
- 5.6 [Reserved]
- 5.7 Operating and Maintenance Manuals. Not later than the Commercial Operation Date, Seller shall provide Company with (i) any and all manufacturer's equipment manuals and recommendations for maintenance and with any updates or supplements thereto within three (3) Business Days after Seller's receipt of same and (ii) a copy of the operating and maintenance manual and shall thereafter provide Company with any amendments thereto within three (3) Business Days after such amendment is adopted.

ARTICLE 6
FORECASTING

- 6.1 Data for Calculation of Availability Factor and Measured Performance Ratio and for Company Forecasts and Monitoring of Compliance. Seller shall provide to Company the meteorological and production data and the Site description information required by Company in order for Company to (i) calculate the Availability Factor and the Measured Performance Ratio as provided in this Agreement, (ii) produce a real-time forecast for operations as well as a Day-ahead forecast and hourly forecasts for all variable generation facilities on the Company System and (iii) monitor Seller's compliance with the Performance Standards set forth in Section 3 (Performance Standards) of the Attachment B (Facility Owned by Seller).
- 6.2 Monitoring and Communication Equipment. Seller shall install and maintain appropriate equipment (the "Monitoring and Communication Equipment") for the purposes of (i) measuring the meteorological and production data required under Section 6.1 (Data for Calculation of Availability Factor and Measured Performance Ratio and for Company Forecasts and Monitoring of Compliance) with an accuracy of not less than that specified for each such data parameter in Section 8 (Data and Forecasting) of Attachment B (Facility Owned by Seller) [**and, if the monitoring equipment is part of the Company-Owned Interconnection Facilities, Section ___ of Attachment G (Company-Owned Interconnection Facilities)**] and (ii) recording and transferring such data to Company in real time. Seller shall maintain at the Site sufficient replacement parts to avoid or otherwise minimize any shutdown of the Facility pursuant to Section 6.4 (Shutdown for Lack of Reliable Real Time Data) of this Agreement while any of the Monitoring and Communication Equipment is being repaired, replaced or re-calibrated.
- 6.3 Calibrations, Maintenance and Repairs.
- (a) Documentation Requirement. Seller shall provide to Company (i) the manufacturer's recommended schedule for the calibration and maintenance of each component of the Monitoring and Communication Equipment and (ii), subject to the limitation set forth in Section 1(a)(ii) of Attachment B (Facility Owned by Seller) of this Agreement, documentation of the performance of all such calibration and maintenance per manufacturer

specifications. Although Company is to receive from Seller the aforesaid recommended schedules for calibration and maintenance, as well documentation of the performance of all such calibration and maintenance, Company shall have no responsibility to monitor Seller's compliance with such calibration and maintenance schedules. Accordingly, any failure by Company to bring Seller's attention any apparent failure by Seller to perform such recommended calibration and maintenance shall neither relieve Seller of its obligations under this Agreement to perform such calibration and maintenance nor constitute a waiver of Company's rights under this Agreement with respect to such failure in performance by Seller.

- (b) Corrective Measures. In the event of a pattern of material inconsistencies in the data stream provided by the Monitoring and Communication Equipment, Seller shall perform, at Seller's expense, such corrective measures as Company may reasonably require, such as the recalibration of all field measurement device components of the Monitoring and Communication Equipment.
- (c) Repairs. In the event of any failure in the Monitoring and Communication Equipment, Seller shall repair or replace such equipment within 15 Days of such failure or within such other time as agreed to by the Company in writing.

6.4 Shutdown For Lack of Reliable Real Time Data. Because the availability to the Company System Operator of reliable meteorological and production information in real time via SCADA is necessary in order for Company to effectively optimize the benefit of its right of Company Dispatch, Company shall have the right to direct Seller to shutdown the Facility due to the unavailability of such reliable real time meteorological and/or production data and the duration of such shutdown shall be included in Downtime for purposes of calculating the Availability Factor under Section 2.5(a) (Calculation of Availability Factor) of this Agreement. In addition, in the event of the performance of corrective measures (including recalibration) and/or repairs to any Monitoring and Communication Equipment pursuant to Section 6.3(b) (Corrective Measures) or Section 6.3(c) (Repairs), Company shall have the right to direct Seller to shutdown the Facility and the Facility shall remain shutdown and shall be included in Downtime for purposes of calculating the

Availability Factor under Section 2.5(a) (Calculation of Availability Factor) of this Agreement until such time as the successful completion of such corrective measures and/or repairs has been demonstrated to Company's reasonable satisfaction.

6.5 Seller Day-Ahead Forecasts of Actual Output.

- (a) Forecasts. To support validation of the Company forecasts referenced in Section 6.1 (Data for Calculation of Availability Factor and Measured Performance Ratio and for Company Forecasts and Monitoring of Compliance), each Day during the Term commencing on the Commercial Operations Date, Seller shall submit to Company Seller's Day-ahead hourly forecasts of the Facility's Actual Output produced by a commercially available forecasting service or by the Seller's documented methodology (i.e., climatology, persistence forecasting) for providing a forecast for the Facility's Actual Output for the next 24 hour period. Hourly Day-ahead forecasts shall be submitted to Company by 1200 Hawai'i Standard Time on each Day immediately preceding a Day on which electric energy from the Facility is to be delivered. Seller shall provide Company with an hourly forecast of Actual Output for each hour of the next Day. Seller shall update such forecast and provide unit availability updates any time information becomes available indicating a change in the forecast of Actual Output from the Facility. The forecasts called for by this Agreement shall be substantially in the form reasonably requested by Company.
- (b) Accuracy of Forecasts. Company acknowledges that the Seller's Day-ahead forecasts are based on forecast estimates and not guarantees. Such limitation notwithstanding, Seller shall exercise commercially reasonable efforts to ensure the accuracy of the Day-ahead forecasts required hereunder for validation purposes and to support Company's forecasts. This includes a detailed description of the methodology used by Seller for forecasting. For example, Seller shall prepare such forecasts and updates by utilizing a solar power forecast or other service that is (i) commercially available or proprietary to Seller, (ii) comparable in accuracy to models or services commonly used in the solar energy industry and that reflect equipment

availability, and (iii) is satisfactory to Company in the exercise of its reasonable discretion.

- (c) Company's Forecasting System. Company currently subscribes to a forecasting service. Company uses such forecasting service to set Company's dispatch schedules for all facilities. Seller, may if it chooses, subscribe to Company's forecasting service, at Seller's cost. If Seller so chooses to subscribe to Company's forecasting service and elects to use such service in lieu of creating its own forecast, Seller shall not be required to provide Day-ahead forecasts pursuant to this Section 6.5 (Seller Day-Ahead Forecasts of Actual Output).

- 6.6 Reports, Studies and Assessment. Prior to the Execution Date, Seller has provided Company with (1) Seller's explanation of the methodology and underlying information used to derive the NEP RFP Projection, including the preliminary design of the Facility and the typical meteorological year file used to estimate the Renewable Resource Baseline, and (2) a written report confirming the reasonableness of NEP RFP Projection, taking into account the Renewable Resource Baseline, the preliminary design of the Facility, the provisions of this Agreement, and any other relevant factors, which report was prepared by an independent consultant experienced in utility scale photovoltaic energy generation and retained by Seller at its expense. The independent consultant was selected from among the entities listed in Section 4(h) (Acceptable Person and Entities) of Attachment U (Calculation and Adjustment of Net Energy Potential) to this Agreement. Throughout the Term, Seller shall, for purposes of facilitating Company's forecasting, deliver to Company, promptly upon Seller's receipt of same, any reports, studies or assessments prepared for the benefit of the Seller by an independent engineer of (i) the electric energy producing potential of the Site or (ii) the Facility.

ARTICLE 7
SELLER PAYMENTS

Seller shall pay to Company (i) all amounts pursuant to Attachment G (Company-Owned Interconnection Facilities), (ii) all amounts pursuant to Section 10.1 (Meters) and Section 10.2 (Meter Testing), (iii) a monthly metering charge of \$25.00 per month, which is in addition to any charges due Company pursuant to the applicable rate schedule pursuant to Section 2.8 (Sales of Electric Energy By Company to Seller) of this Agreement and (iv) such other costs to be incurred by Company and reimbursed by Seller as set forth in this Agreement.

ARTICLE 8
COMPANY DISPATCH

- 8.1 General. Company shall have the right to dispatch all available real and reactive power delivered from the Facility to the Company System and to start up and shut down Seller's generating units, as it deems appropriate in its reasonable discretion, subject only to and consistent with Good Engineering and Operating Practices, the requirements set forth in Attachment B (Facility Owned by Seller), Section 3 (Performance Standards) of this Agreement and Seller's maintenance schedule determined in accordance with Article 5 (Maintenance Records and Scheduling). Company shall not pay for reactive power.
- 8.2 Company Dispatch. Dispatch will either be by Seller's manual control under the direction of the Company System Operator or by remote computerized control by the EMS provided in Section 1(g) (Active Power Control Interface) of Attachment B (Seller's Facility), in each case at Company's reasonable discretion. Notwithstanding anything to the contrary, the power produced by the Facility shall always be subject to dispatch by Company.
- 8.3 Company Rights of Dispatch. Company may require deration or outage in response to the Facility's failure to comply with Company Dispatch, or any of the Performance Standards, Good Engineering and Operating Practices, Government Approvals, applicable Laws or Seller's other obligations under this Agreement. A deration or outage required for this reason shall not be considered ExcludedTime and shall "count against" Seller for the purpose of calculating the Availability Factor until the conditions are resolved by Seller to Company's reasonable satisfaction. Nothing in this Section 8.3 (Company Rights of Dispatch), shall relieve Seller of its obligation under the terms of this Agreement to utilize the full capability of the Facility to deliver the capacity subject to Company Dispatch.
- 8.4 Monthly Report. Commencing with the month during which the Commercial Operations Date is achieved, and for each calendar month thereafter during the Term, Seller shall calculate the Downtime and the ExcludedTime for the calendar month in question, prepare and provide to Company a Monthly Report by the fifth (5th) Business Day of the following month in accordance with Section 1 (Monthly Report) of Attachment T (Monthly Reporting and Dispute Resolution by Independent

AF Evaluator) of this Agreement. Beginning with the Monthly Report for the last calendar month of the initial Contract Year, Seller shall include calculations of the Availability Factor for the LD Period and the Measured Performance Ratio for the LD Period, as well as the calculation of any liquidated damages to be assessed, as set forth in the form of Monthly Report set forth in Section 1 (Monthly Report) of said Attachment T. The rights and obligations of the Parties with respect to each Monthly Report and any disagreements arising out of any Monthly Report are set forth in Section 1 (Monthly Report) and Section 2 (Disagreements Concerning Availability Factor, GPR Benchmark and Measured Performance Ratio) of Attachment T (Monthly Reporting and Dispute Resolution by Independent AF Evaluator) to this Agreement.

ARTICLE 9
PERSONNEL AND SYSTEM SAFETY

Notwithstanding any other provisions of this Agreement, if at any time Company reasonably determines that the Facility may endanger Company's personnel, and/or the continued operation of the Facility may endanger the integrity of the Company System or have an adverse effect on Company's other customers' electric service, Company shall have the right to disconnect the Facility from the Company System, as determined in the sole discretion of the Company System Operator. The Facility shall immediately comply with the dispatch instruction, which may be initiated through remote control, and shall remain disconnected, until such time as Company is satisfied that the condition(s) referred to above have been corrected, and the period during which the Facility is disconnected pursuant to this Article 9 shall constitute a Seller-Attributable Non-Generation. If Company disconnects the Facility from the Company System for personnel or system safety reasons, it shall as soon as practicable notify Seller by telephone, and thereafter confirm in writing, the reasons for the disconnection.

ARTICLE 10
METERING

- 10.1 Meters. Company shall purchase, own, install and maintain the Revenue Metering Package suitable for measuring the export of electric energy from the Facility sold to Company in kilowatts and kilowatt-hours on a time-of-day basis and of reactive power flow in kilovars and true root mean square kilovar-hours. The metering point shall be as close as possible to the Point of Interconnection as allowed by Company. Seller shall make available a mutually agreeable location for the Revenue Metering Package. Seller shall install, own and maintain the infrastructure and other related equipment associated with the Revenue Metering Package, including but not limited to all enclosures (meter cabinets, meter pedestals, meter sockets, pull boxes, and junction boxes, along with their grounding/bonding connections), CT/PT mounting structures, conduits and ductlines, enclosure support structures, ground buses, pads, test switches, terminal blocks, isolation relays, telephone surge suppressors, and analog phone lines (one per meter), subject to Company's review and approval, as further described in Section 1(e) (Other Equipment) of Attachment B (Facility Owned by Seller). The Seller shall install this infrastructure such that it meets the requirements set forth in Chapter Six (IPP Metering) of the latest edition of the Company's Electric Service Installation Manual (ESIM). Company shall test such revenue meter prior to installation and shall test such revenue meter every fifth year. Seller shall reimburse Company for all reasonably incurred costs for the procurement, installation, maintenance (including maintenance replacements) and testing work associated with the Revenue Metering Package.
- 10.2 Meter Testing. Company shall provide at least twenty-four (24) hours' notice to Seller prior to any test it may perform on the revenue meters or metering equipment. Seller shall have the right to have a representative present during each such test. Seller may request, and Company shall perform, if requested, tests in addition to the every fifth-year test and Seller shall pay the cost of such tests. Company may, in its sole discretion, perform tests in addition to the fifth year test and Company shall pay the cost of such tests. If any of the revenue meters or metering equipment is found to be inaccurate at any time, as determined by testing in accordance with this Section 10.2 (Meter Testing), Company shall promptly cause such equipment

to be made accurate, and the period of inaccuracy, as well as an estimate for correct meter readings, shall be determined in accordance with Section 10.3 (Corrections).

- 10.3 Corrections. If any test of revenue meters or metering equipment conducted by Company indicates that the revenue meter readings are in error by one percent (1%) or more, the revenue meters or meter readings shall be corrected as follows: (i) determine the error by testing the revenue meter at approximately ten percent (10%) of the rated current (test amperes) specified for such revenue meter; (ii) determine the error by testing the revenue meter at approximately one hundred percent (100%) of the rated current (test amperes) specified for the revenue meter; (iii) the average meter error shall then be computed as the sum of (aa) one-fifth (1/5) of the error determined in the foregoing clause "(i)" and (bb) four-fifths (4/5) of the error determined in the foregoing clause "(ii)". The average meter error shall be used to adjust the invoices in accordance with Section 2.13 (Adjustment to Invoices After Payment) for the amount of electric energy supplied to Company for the previous six (6) months from Facility, unless records of Company conclusively establish that such error existed for a greater or lesser period, in which case the correction shall cover such actual period of error.

ARTICLE 11
GOVERNMENT APPROVALS,
LAND RIGHTS AND COMPLIANCE WITH LAWS

- 11.1 Governmental Approvals for Facility. Seller shall obtain, at its expense, any and all Governmental Approvals required for the construction, ownership, operation and maintenance of the Facility and the interconnection of the Facility to the Company System.
- 11.2 Land Rights for Facility. Seller shall obtain, at its expense, any and all Land Rights required for the construction, ownership, operation and maintenance of the Facility and the interconnection of the Facility to the Company System. Seller shall provide to Company, no later than the Execution Date, copies of the documents, recorded, if required by Company (including but not limited to any agreements with landowners) (i) establishing the right of Seller to construct, own, operate and maintain the Facility on the Site and (ii) any other Land Rights required for such construction, ownership, operation and maintenance.
- 11.3 Company-Owned Interconnection Facilities. Seller shall, prior to commencement of construction of Company-Owned Interconnection Facilities (whether to be built by Seller or by Company), provide the necessary Governmental Approvals and Land Rights for the interconnection of the Facility to the Company System, including the construction, ownership, operation and maintenance of Company-Owned Interconnection Facilities.
- 11.4 Compliance With Laws. Seller shall at all times comply with all applicable Laws and shall be responsible for all costs and expenses associated therewith.

ARTICLE 12
TERM OF AGREEMENT AND COMPANY'S
OPTION TO PURCHASE AT END OF TERM

- 12.1 Term. Subject to Section 12.2 (Effectiveness of Obligations) of this Agreement, the initial term of this Agreement shall commence upon the Execution Date of this Agreement and, unless terminated sooner as provided in this Agreement, shall remain in effect for **[twenty (20) Contract Years]** following the Commercial Operations Date (the "Initial Term"). This Agreement shall automatically terminate upon expiration of the Initial Term. If the Parties desire, the Parties may negotiate terms and conditions of an extension term ("Extended Term"), including reduced Contract Pricing in recognition that Seller will have recovered its capital and financing costs, which terms and conditions (i) shall be submitted to the PUC by Company for approval no later than one (1) year prior to the expiration of the Initial Term and (ii) shall have no effect without PUC approval.
- 12.2 Effectiveness of Obligations. Only Article 3 (Facility Owned and/or Operated by Seller), Article 12 (Term of Agreement and Company's Option to Purchase at End of Term), Article 14 (Credit Assurance and Security) as it relates to Development Period Security, Article 17 (Indemnification), Article 19 (Transfers, Assignments and Facility Debt), Article 22 (Warranties and Representations), Article 24 (Financial Compliance), Article 28 (Dispute Resolution), Article 29 (Miscellaneous), Section 3 (Seller Payment to Company for Company-Owned Interconnection Facilities and Review of Facility) of Attachment G (Company-Owned Interconnection Facilities) and the Definitions of this Agreement shall become effective on the Execution Date. Except where obligations of the Parties are explicitly stated as being effective before the Effective Date, all other portions of this Agreement shall become effective on the Effective Date.
- 12.3 PUC Approval.
- (a) This Agreement is subject to approval by the PUC in the form of a satisfactory PUC Approval Order and the Parties' respective obligations hereunder are conditioned upon receipt of such approval, except as specifically provided otherwise herein. Upon the Execution Date of this Agreement, the Parties shall

use good faith efforts to obtain, as soon as practicable, a PUC Approval Order that satisfies the requirements of Section 29.20(a) (PUC Approval Order). Company shall submit to the PUC an application for a satisfactory PUC Approval Order but does not extend any assurances that a PUC Approval will ultimately be obtained. Seller will provide reasonable cooperation to expedite obtaining a PUC Approval Order including timely providing information requested by the PUC and parties to the PUC proceeding in which approval is being sought. Seller understands that lack of cooperation may result in Company's inability to file an application with the PUC and/or a failure to receive a PUC Approval Order. For the avoidance of doubt, Company has no obligation to seek reconsideration, appeal, or other administrative or judicial review of any Unfavorable PUC Order. The Parties agree that neither Party has control over whether or not a PUC Approval Order will be issued and each Party hereby assumes any and all risks arising from, or relating in any way to, the inability to obtain a satisfactory PUC Approval Order and hereby releases the other Party from any and all claims relating thereto.

- (b) Seller shall seek participation without intervention in the PUC docket for approval of this Agreement pursuant to applicable rules and orders of the PUC. The scope of Seller's participation shall be determined by the PUC. However, Seller expressly agrees to seek participation for the limited purpose and only to the extent necessary to assist the PUC in making an informed decision regarding the approval of this Agreement. If the Seller chooses not to seek participation in the docket, then Seller expressly agrees and knowingly waives any right to claim, before the PUC, in any court, arbitration or other proceeding, that the information submitted and the arguments offered by Company in support of the application requesting the PUC Approval Order are insufficient to meet Company's burden of justifying that the terms of this Agreement are just and reasonable and in the public interest, or otherwise deficient in any manner for purposes of supporting the PUC's approval of this Agreement. Seller shall not seek in the docket and Company shall not disclose any confidential information to Seller that would provide

Seller with an unfair business advantage or would otherwise harm the position of others with respect to their ability to compete on equal and fair terms.

12.4 Interconnection Requirements Study. If this Agreement is executed prior to completion of the Interconnection Requirements Study, then following the completion of the IRS:

- (a) The Parties shall, no later than the PPA Amendment Deadline, execute a formal amendment to this Agreement substituting new versions of Attachment B (Facility Owned by Seller), Attachment E (Single-Line Drawings and Interface Block Diagram), Attachment F (Relay List and Trip Scheme), Attachment G (Company-Owned Interconnection Facilities), Attachment K (Guaranteed Project Milestones), and Attachment L (Reporting Milestones) (the "Interconnection Requirements Amendment") to reflect the results of the IRS. If the Interconnection Requirements Amendment is not executed by the PPA Amendment Deadline, either Party may, by written notice delivered to the other Party, declare the Agreement null and void; or
- (b) If Seller is dissatisfied with the results of the IRS, Seller shall have the option, by written notice delivered to Company no later than the Termination Deadline, to declare this Agreement null and void. Failure of Seller to declare this Agreement null and void pursuant to the preceding sentence shall not obligate Seller to execute the Interconnection Requirements Amendment.

12.5 Prior to Effective Date. Company may, by written notice delivered prior to the Effective Date, declare the Agreement null and void if any one or more of the following conditions applies:

- (a) Company reasonably determines that the description of the Facility in the Agreement and the IRS no longer represents the Facility Seller is capable of constructing because of changes in the type of, performance specifications of, or availability of equipment.
- (b) Seller is in breach of any of its representations, warranties and covenants under the Agreement,

including, but not limited to, (i) the provisions of Section 22.2(c) requiring Seller to have obtained by the Execution Date all Land Rights necessary for the construction, ownership, operation and maintenance of the Facility for the Initial Term and (ii) the provisions of Section 3(b)(ii) (Company-Owned Interconnection Facilities Prepayment) of Attachment G (Company-Owned Interconnection Facilities) requiring the payment by Seller to Company of the amount specified in said Section 3(b)(ii) within the time period provided in said Section 3(b)(ii).

- (c) Seller, subsequent to making the payment to Company required under Section 3(b)(ii) (Company-Owned Interconnection Facilities Prepayment) of Attachment G (Company-Owned Interconnection Facilities), requests in writing that Company stop or otherwise delay the performance of the work for which Company received such payment.
- (d) Seller has notified Company in writing that it desires to modify (i) the Agreement and/or (ii) the Facility as described in the Agreement and the IRS.
- (e) Seller fails to cause the Facility Lender to make available to Company an IE Energy Assessment report with an NEP IE Estimate that is consistent with the requirements of this Agreement, as more fully provided in Section 1(c) (NEP IE Estimate and Company-Designated NEP Estimate) of Attachment U (Calculation and Adjustment of Net Energy Potential) to this Agreement.

12.6 Time Periods for PUC Submittal Date and PUC Approval.

- (a) Time Period for PUC Submittal Date. If the PUC Submittal Date has not occurred within 120 Days of the Execution Date, or such longer period as Company and Seller may agree to by a subsequent written agreement, Company may, by written notice delivered within 30 Days of the expiration of such period, declare the Agreement null and void if the reason the application has not been filed is (i) any one or more of the conditions set forth in Section 12.5 (Prior to Effective Date) or (ii) Seller's failure to provide in a timely manner information reasonably requested by Company to support such application.

(b) Time Period for PUC Approval. If the Commission issues an Unfavorable PUC Order or if the satisfactory PUC Approval Order is not obtained within twelve (12) months of the PUC Submittal Date, or within such longer period as Company and Seller may agree to by a written agreement ("PUC Approval Time Period"), Company or Seller may, by written notice delivered within one hundred and eighty (180) Days of the Unfavorable PUC Order or the expiration of the PUC Approval Time Period, as applicable, declare this Agreement null and void. In the event the PUC Approval Order is obtained within the PUC Approval Time Period but that Order is appealed, and a Non-appealable PUC Approval Order is not obtained within PUC Approval Time Period, or within such longer period as Company and Seller may agree to by a subsequent written agreement, Company or Seller may, by written notice delivered within ninety (90) Days of the expiration of the PUC Approval Time Period, declare this Agreement null and void.

12.7 Agreement Null and Void. If the Agreement is declared null and void pursuant to Section 12.4 (Interconnection Requirements Study), Section 12.5 (Prior to Effective Date), Section 12.6 (Time Periods for PUC Submittal Date and PUC Approval), Section 1(c) (NEP IE Estimate and Company-Designated NEP Estimate) of Attachment U (Calculation and Adjustment of Net Energy Potential) or Section 1(d) (NEP IE Estimate, Liquidated Damages and Seller's Null and Void Right) of said Attachment U, the Parties hereto shall thereafter be free of all obligations hereunder except as set forth in this Section 12.7 (Agreement Null and Void) and Section 14.3 (Return of Development Period Security), and shall pursue no further remedies against one another; provided, however, that if in response to Seller's request and Seller's offer of adequate assurance of reimbursement, Company agrees in writing to incur costs associated with Company-Owned Interconnection Facilities prior to the Non-appealable PUC Approval Order Date or completion of the IRS, Seller shall pay Company the actual costs and cost obligations incurred by Company as of the date the Agreement is declared null and void for Company-Owned Interconnection Facilities and any reasonable costs incurred thereafter and Company shall refund to Seller any amounts advanced by Seller in excess of such costs. A declaration that this Agreement is null and void pursuant to Section 12.4 (Interconnection Requirements Study), Section 12.5 (Prior to

Effective Date), Section 12.6 (Time Periods for PUC Submittal Date and PUC Approval), Section 1(c) (NEP IE Estimate and Company-Designated NEP Estimate) of Attachment U (Calculation and Adjustment of Net Energy Potential) or Section 1(d) (NEP IE Estimate, Liquidated Damages and Seller's Null and Void Right) of said Attachment U, shall not affect the following provisions, which shall remain in full force and effect: Section 12.2 (Effectiveness of Obligations), this Section 12.7 (Agreement Null and Void), Article 28 (Dispute Resolution), Section 29.3 (Notices), Section 29.8 (Governing Law, Jurisdiction and Venue), Section 29.14 (Settlement of Disputes), Section 29.19 (Computation of Time), Section 29.23 (No Third Party Beneficiaries), Section 29.24 (Hawai'i General Excise Tax), and Section 7 (Land Restoration) of Attachment G (Company-Owned Interconnection Facilities).

- 12.8 Termination Rights. Notwithstanding any of the foregoing, Company or Seller may terminate the Agreement at any time upon the occurrence of any condition described in Article 15 (Events of Default).
- 12.9 Option to Purchase Facility and Right of First Negotiation. Company shall have the right of first negotiation prior to the end of the Term and option to purchase the Facility at the end of the Term, as provided in Attachment P (Sale of Facility by Seller) to this Agreement.

ARTICLE 13
GUARANTEED PROJECT MILESTONES
INCLUDING COMMERCIAL OPERATIONS

[HECO TO DECIDE, FOLLOWING COMPLETION OF IRS, IF ANY GUARANTEED PROJECT MILESTONES ARE NECESSARY IN ADDITION TO THE GUARANTEED SUBSTANTIAL COMMITMENT DATES AND THE GCOD (INCLUDING WHETHER ANY REPORTING MILESTONES SHOULD BECOME GUARANTEED PROJECT MILESTONES) AND, IF SO, WHAT ARE THE CONSEQUENCES OF MISSING SUCH OTHER GUARANTEED PROJECT MILESTONES.]

13.1 Time is of the Essence. Time is of the essence of this Agreement, and Seller's ability to achieve the Construction Milestones is critically important.

13.2 Failure to Meet Certain Reporting Milestones. If Seller does not meet any of the Permit Application Filing Date Milestone, the Construction Financing Closing Milestone or the Construction Start Date Milestone, in each case as set forth in Attachment L (Reporting Milestones), Seller shall submit to Company, within ten (10) Business Days of any such missed Reporting Milestone, a remedial action plan which shall provide a detailed description of Seller's course of action and plan to achieve (i) the missed Reporting Milestone date within ninety (90) Days of the missed Reporting Milestone and (ii) all subsequent Construction Milestones, provided that delivery of any remedial action plan shall not relieve Seller of its obligation to meet any subsequent Construction Milestones.

13.3 Guaranteed Project Milestone Dates. Seller shall achieve each Guaranteed Project Milestone Date, subject (to the extent applicable) to the following grace periods:

- (a) if the failure to achieve Commercial Operations by the Guaranteed Commercial Operations Date is the result of the PUC Approval Order Date occurring more than one hundred eighty (180) Days after the Execution Date, Seller shall be entitled to a grace period following the Guaranteed Commercial Operation Date equal to the lesser of (i) the number of Days that elapse between the end of the aforesaid 180-Day period and the PUC Approval Order Date, or (ii) the number of Days following the Guaranteed Commercial Operations Date that are reasonably necessary for Seller, using reasonable diligence to achieve the Commercial Operations Date in the shortest period of time; **[THIS**

PARAGRAPH SHOULD BE DELETED IF THE GCOD IS A PERIOD OF DAYS MEASURED FROM THE EFFECTIVE DATE RATHER THAN A DATE CERTAIN. NOTE THAT THE "PUC APPROVAL ORDER DATE" IS THE DATE THE ORDER IS ISSUED AND NOT THAT IT BECOMES NON-APPEALABLE.] or

- (b) if the failure to achieve a Guaranteed Project Milestone by the applicable Guaranteed Project Milestone Date is the result of Force Majeure (which, for purposes of this Section 13.3(b) excludes any delay in obtaining the PUC Approval Order because that contingency is addressed in Section 13.3(a) above) **[PRECEDING PARENTHETICAL SHOULD BE DELETED IF SECTION 13.3(a) IS DELETED]**, and if and so long as the conditions set forth in Section 21.4 (Satisfaction of Certain Conditions) are satisfied, Seller shall be entitled to a grace period following such Guaranteed Project Milestone Date equal to the lesser of three hundred sixty-five (365) Days or the duration of the Force Majeure.
- (c) if the failure to achieve a Guaranteed Project Milestone by the applicable Guaranteed Project Milestone Date is the result of any failure by Company in the timely performance of its obligations under this Agreement, Seller shall be entitled to a grace period following such Guaranteed Project Milestone Date equal to the duration of the period of delay directly caused by such failure in Company's timely performance. Such grace period on the terms described above shall be Seller's sole remedy for any such failure by Company. For purposes of this Section 13.3(c), Company's performance will be deemed to be "timely" if it is accomplished within the time period specified in this Agreement with respect to such performance or, if no time period is specified, within a reasonable period of time. If the performance in question is Company's review of plans, the determination of what is a "reasonable period of time" will take into account Company's past practices in reviewing and commenting on plans for similar facilities.

13.4 Damages and Termination.

- (a) Daily Delay Damages.

- (1) If a Guaranteed Project Milestone (other than Commercial Operations) has not been achieved by the applicable Guaranteed Project Milestone Date as extended as provided in Section 13.3 (Guaranteed Project Milestone Dates), Company shall collect and Seller shall pay liquidated damages in the amount of [REDACTED] for each Day ("Daily Delay Damages") following the applicable Guaranteed Project Milestone Date or (if applicable) the expiration of such extended period that Seller fails to achieve the applicable Guaranteed Project Milestone; provided, however, that the number of Days for which Company shall collect and Seller shall pay Daily Delay Damages for a failure to achieve a Guaranteed Project Milestone Date shall not exceed sixty (60) Days for each such missed Guaranteed Project Milestone Date (the "Construction Delay LD Period"). **[Note: Contract Capacity x \$50/kW ÷ 180 Days = Daily Delay Damages.]**
- (2) If the Commercial Operations Date has not been achieved by the Guaranteed Commercial Operations Date as extended as provided in Section 13.3 (Guaranteed Project Milestone Dates), and in addition to any Daily Delay Damages collected pursuant to Section 13.4(a)(1), Company shall collect and Seller shall pay Daily Delay Damages following the Guaranteed Commercial Operations Date or (if applicable) the expiration of such extended period that Seller fails to achieve the Guaranteed Commercial Operations Date, provided that the number of Days for which Company shall collect and Seller shall pay Daily Delay Damages for failing to achieve the Guaranteed Commercial Operations Date shall not exceed one hundred eighty (180) Days (the "COD Delay LD Period").
- (b) Termination and Termination Damages for Failure to Achieve a Guaranteed Project Milestone Date. If, upon the expiration of the Construction Delay LD Period or the COD Delay LD Period, as applicable, Seller has not achieved the Guaranteed Project Milestone Date, Company shall have the right, notwithstanding any other provision of this Agreement to the contrary, to terminate this Agreement with immediate effect by issuing a written termination notice to Seller

designating the Day such termination is to be effective, provided that Company shall issue such notice no later than thirty (30) Days following the expiration of the Construction Delay LD Period or the COD Delay LD Period, as applicable. The effective date of such termination shall be not later than the date that is thirty (30) Days after such notice is deemed to be received by Seller, and not earlier than the later to occur of the Day such notice is deemed to be received by Seller or the Day following the expiration of the Construction Delay LD Period or the COD Delay LD Period, as applicable. Without limiting the generality of the preceding sentence, the earliest Day upon which a termination of this Agreement can be effective as a result of a failure to achieve Guaranteed Project Milestone would be the Day following expiration of the COD Delay LD Period. If the Agreement is terminated by Company pursuant to this Section 13.4 (Damages and Termination), Company shall have the right to collect liquidated damages ("Termination Damages"), which shall be calculated in accordance with Article 16 (Damages in the Event of Termination By Company) of this Agreement.

- 13.5 Payment of Daily Delay Damages. Company shall draw upon the Development Period Security on a monthly basis for payment of the total Daily Delay Damages incurred by Seller during the preceding calendar month. If the Development Period Security is at any time insufficient to pay the amount of the draw to which Company is then entitled, Seller shall pay any such deficiency to Company promptly upon demand.
- 13.6 Liquidated Damages Appropriate. Seller's inability to achieve Commercial Operations by the Guaranteed Commercial Operations Date may cause Company to not meet applicable RPS requirements and require Company to devote substantial additional resources for administration and oversight activities. As such, Company may incur financial consequences for failure to meet such requirements. Consequently, each Party agrees and acknowledges that (i) the damages that Company would incur due to delay in achieving Commercial Operations by the Guaranteed Commercial Operations Date (subject to the grace periods provided in Section 13.3 (Guaranteed Project Milestone Dates)) would be difficult or impossible to calculate with certainty, (ii) the Daily Delay Damages set forth in Section 13.4 (Damages and Termination) are an appropriate approximation

of such damages and (iii) the Daily Delay Damages are the sole and exclusive remedies for Seller's failure to achieve Commercial Operations by the Guaranteed Commercial Operations Date.

- 13.7 Monthly Progress Reports. Commencing upon the Execution Date of this Agreement, Seller shall submit to Company, on the first Day of each calendar month until the Commercial Operations Date is achieved, progress reports in a form set forth on Attachment S (Monthly Progress Report) (the "Monthly Progress Report"). These progress reports shall notify Company of the current status of each Construction Milestone. Seller shall include in such report a list of all letters, notices, applications, filings and Governmental Approvals sent to or received from any Governmental Authority and shall provide any such documents as may be reasonably requested by Company. In addition, Seller shall advise Company as soon as reasonably practicable of any problems or issues of which it is aware which may materially impact its ability to meet the Construction Milestones. Seller shall provide Company with any requested documentation to support the achievement of Construction Milestones within ten (10) Business Days of receipt of such request from Company. Upon the occurrence of a Force Majeure, Seller shall also comply with the requirements of Section 21.4 (Satisfaction of Certain Conditions) to the extent such requirements provide for communications to Company beyond those required under this Section 13.7 (Monthly Progress Reports).

ARTICLE 14
CREDIT ASSURANCE AND SECURITY

- 14.1 General. Seller is required to post and maintain Development Period Security and Operating Period Security based on the requirements of this Article 14 (Credit Assurance and Security).
- 14.2 Development Period Security. To guarantee undertaking the performance of Seller's obligations under the Agreement for the period prior to the Commercial Operations Date (including but not limited to Seller's obligation to meet the Guaranteed Commercial Operations Date), Seller shall provide Development Period Security to Company within ten (10) Days of Execution Date of the Agreement.
- 14.3 Return of Development Period Security. The Development Period Security shall be returned to Seller, subject to Company's right to draw from the Development Period Security as set forth in Section 14.7 (Company's Right to Draw from Security Funds), in the following circumstances: (i) this Agreement is declared null and void pursuant to any of Section 12.4 (Interconnection Requirements Study), Section 12.5 (Prior to Effective Date), Section 12.6 (Time Periods for PUC Submittal Date and PUC Approval), Section 1(c) (NEP IE Estimate and Company-Designated NEP Estimate) of Attachment U (Calculation and Adjustment of Net Energy Potential) or Section 1(d) (NEP IE Estimate, Liquidated Damages and Seller's Null and Void Right) of said Attachment U; (ii) the PUC issues an order denying approval for an application for a PUC Approval Order; (iii) the PUC issues an order that is not a complete approval and which is not satisfactory to Company; or (iv) following Company's receipt of the Operating Period Security, unless the Development Period Security is converted to Operating Period Security pursuant to Section 14.4 (Operating Period Security) of this Agreement.
- 14.4 Operating Period Security. To guarantee the performance of Seller's obligations under the Agreement for the period starting from the Commercial Operations Date to the expiration or termination of this Agreement, Seller shall provide operating period security to Company in the amount of \$75/kW based on the Contract Capacity (the "Operating Period Security"). When the Commercial Operations Date has been achieved, the Development Period Security minus an amount that is due and owing to Company but not previously

paid by Seller (including but not limited to Daily Delay Damages), shall be converted to Operating Period Security unless the Parties otherwise agree. Any additional amount necessary to fully fund the Operating Period Security shall be due within five (5) Days of the Commercial Operations Date.

14.5 Form of Security. Seller shall supply the Development Period and Operating Period Security required in the form of an irrevocable standby letter of credit with no documentation requirement substantially in the form attached to this Agreement as Attachment M (Form of Letter of Credit) from a bank or other financial institution located in the United States with a credit rating of "A-" or better. If the rating (as measured by Standard & Poor's) of the bank or financial institution issuing the standby letter of credit falls below A-, Company may require Seller to replace the standby letter of credit with a standby letter of credit from another bank or financial institution located in the United States with a credit rating of "A-" or better. Such letter of credit shall be issued for a minimum term of one (1) year. Furthermore, at the end of each year the security shall be renewed for an additional one (1) year term so that at the time of such renewal, the remaining term of any such security shall not be less than one (1) year. The letter of credit shall include a provision for at least thirty (30) Days advance notice to Company of any expiration or earlier termination of the letter of credit so as to allow Company sufficient time to exercise its rights under said security if Seller fails to extend or replace the security. In all cases, the reasonable costs and expenses of establishing, renewing, substituting, canceling, increasing, reducing, or otherwise administering the letter of credit shall be borne by Seller.

14.6 Security Funds. The Development Period Security and Operating Period Security (collectively referred to as the "Security Funds") established, funded, and maintained by Seller pursuant to the provisions of this Article 14 (Credit Assurance and Security) shall provide security for the performance of Seller's obligations under this Agreement and shall be available to be drawn on by Company as provided in Section 14.7 (Company's Right to Draw from Security Funds). Seller shall maintain the Security Funds at the contractually-required level throughout the Term of this Agreement. Seller shall replenish the Security Funds to such required level within fifteen (15) Business Days after

any draw on the Security Funds by Company or any reduction in the value of Security Funds below the required level for any other reason.

- 14.7 Company's Right to Draw from Security Funds. In addition to any other remedy available to it, Company may, before or after termination of this Agreement, draw from the Security Funds such amounts as are necessary to recover amounts Company is owed pursuant to this Agreement or the IRS Letter Agreement, including, without limitation, any damages due Company, any interconnection costs owed pursuant to Attachment G (Company-Owned Interconnection Facilities) and any amounts for which Company is entitled to indemnification under this Agreement. Company may, in its sole discretion, draw all or any part of such amounts due Company from any of the Security Funds to the extent available pursuant to this Article 14 (Credit Assurance and Security), and from all such forms, and in any sequence Company may select. Any failure to draw upon the Security Funds or other security for any damages or other amounts due Company shall not prejudice Company's rights to recover such damages or amounts in any other manner.
- 14.8 Failure to Renew or Extend Letter of Credit. If the letter of credit is not renewed or extended at least thirty (30) Days prior to its expiration or earlier termination, Company shall have the right to draw immediately upon the full amount of the letter of credit and to place the proceeds of such draw (the "L/C Proceeds"), at Seller's cost, in an escrow account in accordance with Section 14.9 (L/C Proceeds Escrow), until and unless Seller provides a substitute letter of credit meeting the requirements of this Article 14 (Credit Assurance and Security).
- 14.9 L/C Proceeds Escrow. If Company draws on the letter of credit pursuant to Section 14.8 (Failure to Renew or Extend Letter of Credit), Company shall, in order to avoid comingling the L/C Proceeds, have the right but not the obligation to place the L/C Proceeds in an escrow account as provided in this Section 14.9 (L/C Proceeds Escrow) with a reputable escrow agent acceptable to Company ("Escrow Agent"). Without limitation to the generality of the foregoing, a federally-insured bank shall be deemed to be a "reputable escrow agent." Company shall have the right to apply the L/C Proceeds as necessary to recover amounts Company is owed pursuant to this Agreement or the IRS Letter Agreement, including, without limitation, any damages due

Company, any interconnection costs owed pursuant to Attachment G (Company-Owned Interconnection Facilities) and any amounts for which Company is entitled to indemnification under this Agreement. To that end, the documentation governing such escrow account shall be in form and content satisfactory to Company and shall give Company the sole authority to draw from the account. Seller shall not be a party to such documentation and shall have no rights to the L/C Proceeds. Upon full satisfaction of Seller's obligations under this Agreement, including recovery by Company of amounts owed to it under this Agreement, Company shall instruct the Escrow Agent to remit to the bank that issued the letter of credit that was the source of the L/C Proceeds the remaining balance (if any) of the L/C Proceeds. If there is more than one escrow account with L/C Proceeds, Company may, in its sole discretion, draw on such accounts in any sequence Company may select. Any failure to draw upon the L/C Proceeds for any damages or other amounts due Company shall not prejudice Company's rights to recover such damages or amounts in any other manner.

- 14.10 Release of Security Funds. Promptly following the end of the Term, and the complete performance of all of Seller's obligations under this Agreement, including but not limited to the obligation to pay any and all amounts owed by Seller to Company under this Agreement, Company shall release the Security Funds to Seller.

ARTICLE 15
EVENTS OF DEFAULT

- 15.1 Events of Default by Seller. The occurrence of any of the following shall constitute an Event of Default by Seller:
- (a) if at any time during the Term, Seller delivers or attempts to deliver to the Point of Interconnection for sale under this Agreement electric energy that was not generated by the Facility;
 - (b) if at any time subsequent to the Commercial Operations Date, the Availability Factor is less than **84%** for each of three consecutive Contract Years;
 - (c) if at any time subsequent to the Commercial Operations Date, the Measured Performance Ratio for each of three consecutive Contract Years falls below the Tier 2 Bandwidth for such Contract Year;
 - (d) if at any time subsequent to the Commercial Operations Date, the Facility is unavailable to provide electric energy in response to Company Dispatch for a period of three hundred sixty-five (365) or more consecutive Days;
 - (e) if at any time during the Term, Seller fails to satisfy the Credit Assurance and Security requirements agreed to pursuant to Article 14 (Credit Assurance and Security) of this Agreement;
 - (f) if at any time during the Term, Seller fails to comply with the requirements of Section 19.1 (Sale of Facility) and Attachment P (Sale of Facility by Seller);
 - (g) if at any time during the Term, the Facility Lender declares a default under the Financing Documents and then fails to initiate, within sixty (60) Days thereafter, such actions as may be legally necessary (such as foreclosure) to take possession of the Facility and to thereafter diligently prosecute such actions to conclusion; or
 - (h) if at any time subsequent to the Commercial Operations Date, Seller fails to install, operate, maintain, or repair the Facility in accordance with Good Engineering and Operating Practices if such failure is

not cured within thirty (30) Days after written notice of such failure from Company unless such failure cannot be cured within said thirty (30) Day period and Seller is making commercially reasonable efforts to cure such failure, in which case Seller shall have a cure period of one hundred eighty (180) Days after Company's written notice of such failure.

[DRAFTING NOTE FOR MECO: IF PROJECT IS LOCATED AT MECO'S WAENA SITE, PPA IS TO BE CROSS-DEFAULTED TO GROUND LEASE.]

15.2 Events of Default by a Party. The occurrence of any of the following during the Term of the Agreement shall constitute an Event of Default by the Party responsible for the failure, action or breach in question:

- (a) The failure to make any payment required pursuant to this Agreement when due if such failure is not cured within ten (10) Business Days after written notice is received by the Party failing to make such payment;
- (b) Any representation or warranty made by such Party herein is false and misleading in any material respect when made;
- (c) Such Party becomes insolvent, or makes an assignment for the benefit of creditors or fails generally to pay its debts as they become due; or such Party shall have an order for relief in an involuntary case under the bankruptcy laws as now or hereafter constituted entered against it, or shall commence a voluntary case under the bankruptcy laws as now or hereafter constituted, or shall file any petition or answer seeking for itself any arrangement, composition, adjustment, liquidation, dissolution or similar relief to which it may be entitled under any present or future statute, law or regulation, or shall file any answer admitting the material allegations of any petition filed against it in such proceeding; or such Party seeks or consents to or acquiesces in the appointment of or taking possession by, any custodian, trustee, receiver or liquidator of it or of all or a substantial part of its properties or assets; or such Party takes action looking to its dissolution or liquidation; or within ninety (90) days after commencement of any proceedings against such Party seeking any arrangement, composition, adjustment,

liquidation, dissolution or similar relief under any present or future statute, law or regulation, such proceedings shall not have been dismissed; or within ninety (90) days after the appointment of, or taking possession by, any custodian, trustee, receiver or liquidator of any or of all or a substantial part of the properties or assets of such Party, without the consent or acquiescence of such Party, any such appointment or possession shall not have been vacated or terminated;

- (d) Such Party engages in or is the subject of a transaction requiring the prior written consent of the other Party under Section 19.2 (Assignment by Seller) or Section 19.7 (Assignment By Company) (as applicable) without having obtained such consent;
- (e) Such Party fails to comply with either (i) decision under Article 28 (Dispute Resolution), (ii) or an Independent Evaluator's decision under Article 23 (Process for Addressing Revisions to Performance Standards), in either case within thirty (30) Days after such decision becomes binding on the Parties in accordance with Article 28 (Dispute Resolution) or within thirty (30) Days of the issuance of such decision under Article 23 (Process for Addressing Revisions to Performance Standards), as applicable, or, if such decision cannot be complied with within thirty (30) Days, such Party fails to have commenced commercially reasonable efforts designed to achieve compliance within such thirty (30) Days and diligently continue such commercially reasonable efforts until compliance is attained; or
- (f) A Party, by act or omission, materially breaches or defaults on any material covenant, condition or other provision of this Agreement, other than the provisions specified in Section 15.1 (Events of Default by Seller) and Section 15.2(a) through Section 15.2(e), if such breach or default is not cured within thirty (30) Days after written notice of such breach or default from the other Party; provided, however, that if it is objectively impossible to cure the breach or default in question within said thirty (30) Day period (i.e., if the breach or default in question is one that could not be cured within said thirty (30) Day period by an experienced independent power producer or

electric utility, as applicable, willing and able to exert commercially reasonable efforts to achieve such cure within said thirty (30) Day period), then, for so long as the Non-performing Party is making the same effort to cure such breach or default as would be expected of an experienced independent power producer or electric utility, as applicable, willing and able to exert commercially reasonable efforts to achieve such cure, the Non-performing Party shall have a cure period equal to the shorter of (i) the duration of the period within which a cure could reasonably be expected to be achieved by an experienced independent power producer or electric utility, as applicable, willing and able to exert commercially reasonable efforts to achieve such cure or (ii) a period of three hundred sixty five (365) Days beginning on the date of written notice of such breach or default; provided, further, that if the material breach in question involves Seller's failure to meet the operational and performance standards set forth in Attachment B (Seller's Facility), the provisions of Section 1(j) (Demonstration of Facility) for consultant's study and Seller implementation of such study's recommendation shall apply in lieu of the extended cure period provided under the preceding proviso.

15.3 Cure/Grace Periods. Before becoming an Event of Default, the occurrences set forth in Section 15.1 (Events of Default by Seller) and Section 15.2 (Events of Default by a Party) are subject to the following cure/grace periods:

- (a) If the occurrence is not the result of Force Majeure, the Non-performing Party shall be entitled to a cure period to the limited extent expressly set forth in the applicable provision of Section 15.1 (Events of Default by Seller) or Section 15.2 (Events of Default by a Party); or
- (b) If the occurrence is the result of Force Majeure, and if and so long as the conditions set forth in Section 21.4 (Satisfaction of Certain Conditions) are satisfied, the Non-performing Party shall be entitled to a grace period as provided in Section 21.6 (Events of Default), which shall apply in lieu of any cure periods provided in Section 15.1 (Events of Default by Seller) and Section 15.2 (Events of Default by a Party).

- 15.4 Rights of the Non-defaulting Party; Forward Contract. If an Event of Default shall have occurred and be continuing, the Party who is not the Defaulting Party ("Non-defaulting Party") shall have the right (i) to terminate this Agreement by sending written notice to the Defaulting Party as provided in this Section 15.4 (Rights of the Non-defaulting Party; Forward Contract); (ii) to withhold any payments due to the Defaulting Party under this Agreement; (iii) suspend performance; and (iv) exercise any other right or remedy available at law or in equity to the extent permitted under this Agreement. A notice terminating this Agreement pursuant to this Section 15.4 (Rights of the Non-defaulting Party; Forward Contract) shall designate the Day such termination is to be effective which Day shall be no later than thirty (30) Days after such notice is deemed to be received by the Defaulting Party and not earlier than the first to occur of the Day such notice is deemed to be received by the Defaulting Party or the Day following the expiration of any period afforded the Defaulting Party under Section 15.1 (Events of Default by Seller) and Section 15.2 (Events of Default by a Party) to cure the default in question. If the Agreement is terminated by Company because of one or more of the Events of Default by Seller, Company shall have the right, in addition to the rights set forth above in this Section 15.4 (Rights of the Non-defaulting Party; Forward Contract), to collect liquidated damages ("Termination Damages"), in accordance with Article 16 (Damages in the Event of Termination by the Company). Without limitation to the generality of the foregoing provisions of this Section 15.4 (Rights of the Non-Defaulting Party; Forward Contract), the Parties agree that, under 11 U.S.C. §362(b)(6), this Agreement is a "forward contract" and the Company is a "forward contract merchant" such that upon the occurrence of an Event of Default by Seller under Section 5.1 (Events of Default by Seller) or Section 15.2 (Events of Default by a Party), this Agreement may be terminated by Company as provided in this Agreement notwithstanding any bankruptcy petition affecting Seller.
- 15.5 Force Majeure. To the extent a Non-performing Party is entitled to defer certain liabilities pursuant to Article 21 (Force Majeure) of the Agreement, the permitted period of deferral shall be governed by Section 21.6 (Events of Default) in lieu of this Article 15 (Events of Default).
- 15.6 Guaranteed Project Milestones Including Guaranteed Commercial Operations Date. Notwithstanding any other

provision of this Article 15 (Events of Default) to the contrary, any failure of Seller to achieve any of the Guaranteed Project Milestones by the applicable Guaranteed Project Milestone Date, including Commercial Operations by the Guaranteed Commercial Operations Date, shall be governed by Article 13 (Guaranteed Project Milestones Including Commercial Operations) in lieu of this Article 15 (Events of Default).

- 15.7 Equitable Remedies. Seller acknowledges that Company is a public utility and is relying upon Seller's performance of its obligations under this Agreement, and that Company and/or its customers may suffer irreparable injury as a result of the failure of Seller to perform any of such obligations, whether or not such failure constitutes an Event of Default or otherwise gives rise to one or more of the remedies set forth in Section 15.4 (Rights of the Non-defaulting Party; Forward Contract). Accordingly, the remedies set forth in Section 15.4 (Rights of the Non-defaulting Party; Forward Contract) shall not limit or otherwise affect Company's right to seek specific performance injunctions or other available equitable remedies for Seller's failure to perform any of its obligations under this Agreement, irrespective of whether such failure constitutes an Event of Default.

ARTICLE 16
DAMAGES IN THE EVENT OF TERMINATION BY COMPANY

- 16.1 Termination Due to Failure to Meet a Guaranteed Project Milestone Date. If the Agreement is terminated by Company pursuant to Section 13.4 (Damages and Termination), Company shall be entitled to Termination Damages calculated by multiplying the Contract Capacity by \$50/kW.
- 16.2 Termination Due to an Event of Default. If the Agreement is terminated by Company in accordance with this Agreement after the Commercial Operations Date due to an Event of Default where Seller is the Defaulting Party, Company shall be entitled to Termination Damages calculated by multiplying the Contract Capacity by \$75/kW.
- 16.3 Liquidated Damages Appropriate. Each Party agrees and acknowledges that (i) the damages that Company would incur due to early termination of the Agreement pursuant to either Section 13.4 (Damages and Termination) or Section 15.4 (Rights of the Non-defaulting Party; Forward Contract) would be difficult or impossible to calculate with certainty, (ii) the Termination Damages are an appropriate approximation of such damages, and (iii) payment of Termination Damages does not relieve Seller of liability for costs and balances incurred prior to the effective date of such termination. The Termination Damages are the sole and exclusive remedy for Company's losses arising out of the termination of this Agreement. The Termination Damages are not intended to limit Company's rights or remedies, or Seller's liabilities or duties, with respect to losses arising independent of the termination of this Agreement, including, without limitation, Company's right to recover under Section 17.1 (Indemnification of Company).
- 16.4 Consequential Damages. Neither Party shall be liable for damages incurred by the other Party for any loss of profit or revenues, loss of product, loss of use of products or services or associated equipment, interruption of business, cost of capital, downtime costs, increased operating costs, or for any special, consequential, incidental, indirect or punitive damages; provided, however, that nothing in this Section 16.4 (Consequential Damages) shall limit any of (i) the indemnification obligations of either Party under Article 17 (Indemnification) of this Agreement, (ii) the liability of either Party for liquidated damages as set forth in this Agreement, (iii) the liability of either Party

for direct damages for breach of this Agreement as and to the extent such damages have not been liquidated as set forth in this Agreement or (iv) the liability of either Party for gross negligence or intentional misconduct.

ARTICLE 17
INDEMNIFICATION

17.1 Indemnification of Company.

- (a) Indemnification Against Third Party Claims. Seller shall indemnify, defend, and hold harmless Company, its successors, permitted assigns, affiliates, controlling persons, directors, officers, employees, agents, contractors, subcontractors and the employees of any of them (collectively referred to as an "Indemnified Company Party"), from and against any Losses suffered, incurred or sustained by any Indemnified Company Party due to any Claim (whether or not well founded, meritorious or unmeritorious) by a third party not controlled by, or under common ownership and/or control with, Company relating to (i) Seller's development, permitting, construction, ownership, operation and/or maintenance of the Facility or (ii) any actual or alleged personal injury or death or damage to property, in any way arising out of, incident to, or resulting directly or indirectly from the acts or omissions of any Indemnified Seller Party, except as and to the extent that such Loss is attributable to the gross negligence or willful misconduct of an Indemnified Company Party.
- (b) Compliance with Laws. Any Losses incurred by an Indemnified Seller Party for noncompliance by Seller or an Indemnified Seller Party with applicable Laws shall not be reimbursed by Company but shall be the sole responsibility of Seller. Seller shall indemnify, defend and hold harmless each Indemnified Company Party from and against any and all Losses in any way arising out of, incident to, or resulting directly or indirectly from the failure of Seller to comply with any Laws.
- (c) Notice. If Seller shall obtain knowledge of any Claim subject to Section 17.1(a) (Indemnification Against Third Party Claims), Section 17.1(b) (Compliance with Laws) or otherwise under this Agreement, Seller shall give prompt notice thereof to Company, and if Company shall obtain any such knowledge, Company shall give prompt notice thereof to Seller.
- (d) Indemnification Procedures.

- (1) In case any Claim subject to Section 17.1(a) (Indemnification Against Third Party Claims) or Section 17.1(b) (Compliance with Laws) or otherwise under this Agreement, shall be brought against an Indemnified Company Party, Company shall notify Seller of the commencement thereof and, provided that Seller has acknowledged in writing to Company its obligation to an Indemnified Company Party under this Section 17.1 (Indemnification of Company), Seller shall be entitled, at its own expense, acting through counsel acceptable to Company, to participate in and, to the extent that Seller desires, to assume and control the defense thereof; provided, however, that Seller shall not compromise or settle a Claim against an Indemnified Company Party without the prior written consent of Company which consent shall not be unreasonably withheld.

- (2) Seller shall not be entitled to assume and control the defense of any such Claim subject to Section 17.1(a) (Indemnification Against Third Party Claims), Section 17.1(b) (Compliance with Laws) or otherwise under this Agreement, if and to the extent that, in the sole opinion of Company, such Claim involves the potential imposition of criminal liability on an Indemnified Company Party or a conflict of interest between an Indemnified Company Party and Seller, in which case Company shall be entitled, at its own expense, acting through counsel acceptable to Seller to participate in any Claim, the defense of which has been assumed by Seller. Company shall supply Seller with such information and documents requested by Seller as are necessary or advisable for Seller to possess in connection with its participation in any Claim to the extent permitted by this Section 17.1(d)(2). An Indemnified Company Party shall not enter into any settlement or other compromise with respect to any Claim without the prior written consent of Seller, which consent shall not be unreasonably withheld or delayed.

- (3) Upon payment of any Losses by Seller, pursuant to this Section 17.1 (Indemnification of Company) or other similar indemnity provisions contained herein, to or on behalf of Company, Seller, without

any further action, shall be subrogated to any and all claims that an Indemnified Company Party may have relating thereto.

- (4) Company shall fully cooperate and cause all Company Indemnified Parties to fully cooperate, in the defense of or response to, any Claim subject to Section 17.1 (Indemnification of Company).

17.2 Indemnification of Seller.

- (a) Indemnification Against Third Party Claims. Company shall indemnify, defend, and hold harmless Seller, its successors, permitted assigns, affiliates, controlling persons, directors, officers, employees, servants and agents, contractors, subcontractors and the employees of any of them (collectively referred to as an "Indemnified Seller Party"), from and against any Losses suffered, incurred or sustained by any Indemnified Seller Party due to any Claim by a third party not controlled by or under common ownership and/or control with Seller (whether or not well founded, meritorious or unmeritorious) relating to any actual or alleged personal injury or death or damage to property, in any way arising out of, incident to, or resulting directly or indirectly from the acts or omissions of any Indemnified Company Party, except to the extent that any such Loss is attributable to the gross negligence or willful misconduct of an Indemnified Seller Party.
- (b) Notice. If Company shall obtain knowledge of any Claim subject to Section 17.2(a) (Indemnification Against Third Party Claims) or otherwise under this Agreement, Company shall give prompt notice thereof to Seller, and if Seller shall obtain any such knowledge, Seller shall give prompt notice thereof to Company.
- (c) Indemnification Procedures.
- (1) In case any action, suit or proceeding subject to Section 17.2(a) (Indemnification Against Third Party Claims), or otherwise under this Agreement, shall be brought against an Indemnified Seller Party, Seller shall notify Company of the commencement thereof and, provided that Company has acknowledged in writing to Seller its obligation to an Indemnified Seller Party under this Section 17.2

(Indemnification of Seller), Company shall be entitled, at its own expense, acting through counsel acceptable to Seller, to participate in and, to the extent that Company desires, to assume and control the defense thereof; provided, however, that Company shall not compromise or settle a Claim against an Indemnified Seller Party without the prior written consent of Seller which consent shall not be unreasonably withheld.

- (2) Company shall not be entitled to assume and control the defense of any such Claim subject to Section 17.2(a) (Indemnification Against Third Party Claims), or otherwise under this Agreement, if and to the extent that, in the opinion of Seller, such Claim involves the potential imposition of criminal liability on an Indemnified Seller Party or a conflict of interest between an Indemnified Seller Party and Company, in which case Seller shall be entitled, at its own expense, acting through counsel acceptable to Company, to participate in any Claim the defense of which has been assumed by Company. An Indemnified Seller Party shall supply Company with such information and documents requested by Company as are necessary or advisable for Company to possess in connection with its participation in any Claim, to the extent permitted by this Section 17.2(c)(2). An Indemnified Seller Party shall not enter into any settlement or other compromise with respect to any Claim without the prior written consent of Company, which consent shall not be unreasonably withheld or delayed.
- (3) Upon payment of any Losses by Company pursuant to this Section 17.2 (Indemnification of Seller) or other similar indemnity provisions contained herein to or on behalf of Seller, Company, without any further action, shall be subrogated to any and all claims that an Indemnified Seller Party may have relating thereto.
- (4) Seller shall fully cooperate and cause all Seller Indemnified Parties to fully cooperate, in the defense of, or response to, any Claim subject to Section 17.2 (Indemnification of Seller).

ARTICLE 18
INSURANCE

- 18.1 Required Coverage. Seller, and anyone acting under its direction or control or on its behalf, shall, at its own expense, acquire and maintain, or cause to be maintained in full effect, commencing with the start of construction of the Facility, as applicable, and continuing throughout the Term, as applicable, the minimum insurance coverage set forth in Attachment R (Required Insurance), or such higher amounts as the Seller and/or the Facility Lender reasonably determines to be necessary during construction and operation of the Facility. Seller's indemnity and other obligations shall not be limited by the foregoing insurance requirements. Any deductible shall be the responsibility of Seller.
- 18.2 Waiver of Subrogation. Seller, and anyone acting under its direction or control or on its behalf, shall cause its insurers to waive all rights of subrogation which Seller or its insurers may have against Company, Company's agents, or Company's employees.
- 18.3 Additional Insureds. The insurance policies specified in Section 2 (General Liability Insurance) and Section 3 (Automobile Liability Insurance) of Attachment R (Required Insurance) shall name Company as an additional insured, as its interests may appear, with respect to any and all third party bodily injury and/or property damage claims, including completed operations, arising from Seller's performance of this Agreement, and Seller shall submit to Company a copy of such additional insured endorsement with evidence of insurance as required herein. The insurance policies specified in Section 4 (Builders All Risk Insurance) and Section 5 (All Risk Property/Comprehensive Boiler and Machinery Insurance (Upon Completion of Construction)) of Attachment R (Required Insurance) shall include Company as loss payee, as its interest may appear with respect to any Property or Boiler and Machinery losses. Seller shall immediately provide written notice to Company should any of the insurance policies required under this Agreement be cancelled, materially modified, or not renewed upon expiration. Company acknowledges that the Facility Lender shall be entitled to receive and distribute any and all loss proceeds as stipulated by any Financing Documents related to any policy described in this Article 18 (Insurance) and Attachment R (Required Insurance).

- 18.4 Evidence of Policies Provided to Company. Evidence of insurance for the coverage specified in this Article 18 (Insurance) shall be provided to Company within thirty (30) Days after the Effective Date or prior to the start of construction, whichever shall first occur. Within 30 Days of any change of any policy and upon renewal of any policy, Seller shall provide certificates of insurance to Company. During the Term, Seller, upon Company's reasonable request, shall make available to Company for its inspection at Seller's designated location, certified copies of the insurance policies described in this Article 18 (Insurance) and Attachment R (Required Insurance). Receipt of any evidence of insurance showing less coverage than requested is not a waiver of Seller's obligations to fulfill the requirements.
- 18.5 Deductibles. Company acknowledges that any policy required herein may contain reasonable deductibles or self-insured retentions, the amounts of which will be reviewed for acceptance by Company. Acceptance will not be unreasonably withheld.
- 18.6 Application of Proceeds from All Risk Property/Comprehensive Boiler and Machinery Insurance. Seller shall use commercially reasonable efforts to obtain provisions in the Financing Documents, on reasonable terms, providing for the insurance proceeds from All Risk Property/Comprehensive Boiler and Machinery Insurance to be applied to repair of the Facility.
- 18.7 Annual Review by Company. The coverage limits shall be reviewed annually by Company and if, in Company's discretion, Company determines that the coverage limits should be increased, Company shall so notify Seller. Seller shall, within thirty (30) Days of notice from Company, increase the coverage as directed in such notice and the costs of such increased coverage limits shall be borne by Seller.
- 18.8 No Representation of Coverage Adequacy. By requiring insurance herein, Company does not represent that coverage and limits will necessarily be adequate to protect Seller, and such coverage and limits shall not be deemed as a limitation on Seller's liability under the indemnities granted to Company in this Agreement.
- 18.9 General Insurance Requirements.

- (a) Each policy shall be specifically endorsed by blanket or otherwise to provide that Seller's insurance is primary. Any other insurance carried by Company will be excess only and not contribute with this insurance.
- (b) Each policy is to be written by an insurer with a rating by A.M. Best Company, Inc. of "A-VII" or better.
- (c) If the limits of available liability coverage required herein become substantially reduced as a result of claim payments, Seller shall immediately, at its own expense, purchase additional liability insurance (if such coverage is available at commercially reasonable rates) to increase the amount of available coverage to the limits of liability coverage required herein.

ARTICLE 19
TRANSFERS, ASSIGNMENTS, AND FACILITY DEBT

- 19.1 Sale of the Facility. Seller shall comply with the requirements of Attachment P (Sale of Facility by Seller) before (i) Seller's right, title or interest in the Facility, in whole or in part, may be disposed of, or (ii) any Ownership Interest is disposed of, or any change in Ownership Control occurs. Any attempt by Seller to make any such disposition or change in control without fulfilling the requirements of Attachment P (Sale of Facility by Seller) shall be deemed null and void and shall constitute an Event of Default pursuant to Article 15 (Events of Default).
- 19.2 Assignment by Seller. Seller may not assign, pledge, mortgage, grant a security interest in or collaterally assign this Agreement, the Facility or any interest in the Facility (including any Ownership Interest or Ownership Control) without the prior consent of Company (such consent not to be unreasonably withheld, conditioned or delayed), provided that Seller shall have the right, without the consent of Company to assign its interest in this Agreement to a wholly-owned subsidiary or to an affiliated company under common control with _____, provided that such assignment does not impair the ability of Seller to perform its obligations under this Agreement.
- 19.3 Company's Acknowledgment. In connection with any assignment relating to the Facility Debt to which Company consents pursuant to Section 19.2 (Assignment by Seller), Company shall, if requested by Seller and if its costs (including reasonable attorneys' fees of outside counsel) in responding to such request are paid by Seller: (i) execute such Hawai'i-law-governed documents as may be reasonably requested by the Facility Lender to acknowledge such assignment and/or pledge/mortgage and the right of the Facility Lender to (aa) receive copies of notices of Events of Default where the Seller is the Defaulting Party and (bb) have reasonable opportunity to cure such Events of Default and to exercise remedies to assume Seller's obligations under this Agreement; and (ii) provide a legal opinion as to the due authorization of such Company acknowledgment.
- 19.4 Financing Document Requirements. In connection with any Facility Debt to which Company consents pursuant to Section 19.2 (Assignment by Seller), Seller shall use commercially reasonable efforts to obtain Financing Documents in a form

reasonably satisfactory to Company which contain the following provisions for Company's benefit:

- (a) Each Facility Lender shall make a binding commitment to Company, in a manner legally enforceable by Company, that so long as this Agreement is in effect and there shall not exist and remain continuing any Event of Default by Company, such Facility Lender will take no action (except pursuant to rights granted to Seller under this Agreement) to disturb, affect or impair Company's rights under this Agreement, including without limitation its rights to dispatch the Facility, nor to terminate or otherwise adversely affect this Agreement, by means of (i) the exercise of any of its rights and remedies of foreclosure or sale afforded by the terms of the Financing Documents or by law in respect of the Facility; or (ii) any other suit, action or proceeding upon the Financing Documents or the exercise of any other rights of such Facility Lender pursuant to any other documents or as a matter of law.
- (b) Each Facility Lender shall agree: (i) to give written notice to Company of any event of default by Seller and any event known to such Facility Lender which, with notice or the passage of time or both, would constitute an event of default by Seller, under any Financing Documents; and (ii) to afford Company the right to cure any such event of default within sixty (60) Days after notice to Company of such event of default, and to forbear from exercising any right or remedy available to such Facility Lender in respect of such event of default during such cure period.
- (c) Each Facility Lender shall agree that in the event of default by Seller under any Financing Documents, Company shall have the option in Company's sole discretion to (i) cure Seller's default without assuming Seller's obligations under the Financing Documents; or (ii) cure Seller's default and directly or by an affiliate assume Seller's obligations under the Financing Documents.

19.5 Grant of Security Interest. In the event that the Facility Debt requires the grant of a security interest (including a mortgage) in this Agreement and/or the Facility, Seller shall provide Company with summaries of the material terms

of the Financing Documents, amendments or modifications thereto, and copies of the Financing Documents. Such summaries and documents shall be provided to Company prior to Seller consummating the financing or refinancing to allow for a reasonable amount of time for Company to review such summaries and documents. The terms and conditions of such financing and refinancing shall be subject to Company's review and consent, which shall not be unreasonably withheld or delayed.

- 19.6 Reimbursement of Company Costs. Seller shall reimburse Company for costs and expenses incurred by Company (including reasonable attorneys' fees of outside counsel) in responding to Facility Lender's requests or as a result of any event of default by Seller under the Financing Documents, including but not limited to any attempt to cure such event of default undertaken by Company as provided in Section 19.4(b) and Section 19.4(c) or any assumption of Seller's obligations under Section 19.4(c).
- 19.7 Assignment By Company. This Agreement shall not be assigned by Company without the prior written consent of Seller (which consent shall not be unreasonably withheld, conditioned or delayed); provided, however, that Company shall have the right, without the consent of Seller, to assign its interest in this Agreement to any affiliated company owned in whole or in part by Hawaiian Electric Industries, Inc.; provided, further, that such assignment does not impair the ability of Seller to continue to receive the payments it is entitled to under this Agreement.
- 19.8 Consequences for Failure to Comply. Any attempt to make any pledge, mortgage, grant of a security interest or collateral assignment for which consent is required under Section 19.2 (Assignment by Seller) or Section 19.7 (Assignment By Company) (as applicable), without fulfilling the requirements of this Article 19 (Transfers, Assignments, and Facility Debt) shall be null and void and shall constitute an Event of Default pursuant to Article 15 (Events of Default).

ARTICLE 20
SALE OF ENERGY TO THIRD PARTIES

Seller shall not sell energy from the Facility to any Third Party.

ARTICLE 21
FORCE MAJEURE

21.1 Definition of Force Majeure. The term "Force Majeure", as used in this Agreement, means any occurrence that:

- (a) In whole or in part delays or prevents a Party's performance under this Agreement;
- (b) Is not the direct or indirect result of the fault or negligence of that Party;
- (c) Is not within the control of that Party notwithstanding such Party having taken all reasonable precautions and measures in order to prevent or avoid such event; and
- (d) The Party has been unable to overcome by the exercise of due diligence.

21.2 Events That Could Qualify as Force Majeure. Subject to the foregoing, events that could qualify as Force Majeure include, but are not limited to, the following:

- (a) acts of God, flooding, lightning, landslide, earthquake, fire, drought, explosion, epidemic, quarantine, storm, hurricane, tornado, volcano, other natural disaster or unusual or extreme adverse weather-related events;
- (b) war (declared or undeclared), riot or similar civil disturbance, acts of the public enemy (including acts of terrorism), sabotage, blockade, insurrection, revolution, expropriation or confiscation; or
- (c) except as set forth in Section 21.3(j) (Exclusions from Force Majeure), strikes, work stoppage or other labor disputes (in which case the affected Party shall have no obligation to settle the strike or labor dispute on terms it deems unreasonable).

21.3 Exclusions From Force Majeure. Force Majeure does not include:

- (a) any acts or omissions of any Third Party, including, without limitation, any vendor, materialman, customer, or supplier of Seller, unless such acts or omissions are themselves excused by reason of Force Majeure;

- (b) any full or partial reduction in the electric output of Facility that is caused by or arises from (i) a mechanical or equipment breakdown or (ii) other mishap or events or conditions attributable to normal wear and tear or defects, unless such mishap is caused by Force Majeure;
- (c) changes in market conditions that affect the cost of Seller's supplies, or that affect demand or price for any of Seller's products, or that otherwise render this Agreement uneconomic or unprofitable for Seller;
- (d) Seller's inability to obtain Governmental Approvals or Land Rights for the construction, ownership, operation and maintenance of Facility and the Company-Owned Interconnection Facilities, or Seller's loss of any such Governmental Approvals or Land Rights once obtained;
- (e) the lack of wind, sun or any other resource of an inherently intermittent nature;
- (f) Seller's inability to obtain sufficient fuel, power or materials to operate its Facility, except if Seller's inability to obtain sufficient fuel, power or materials is caused solely by an event of Force Majeure;
- (g) Seller's failure to obtain additional funds, including funds authorized by a state or the federal government or agencies thereof, to supplement the payments made by Company pursuant to this Agreement;
- (h) a Forced Outage except where such Forced Outage is caused by an event of Force Majeure;
- (i) litigation or administrative or judicial action pertaining to the Agreement, the Site, the Facility, the Land Rights, the acquisition, maintenance or renewal of financing or any Governmental Approvals, or the design, construction, ownership, operation or maintenance of the Facility, the Company-Owned Interconnection Facilities or the Company System;
- (j) a strike, work stoppage or labor dispute limited only to any one or more of the Indemnified Seller Parties

or any other third party employed by Seller to work on the Project; or

- (k) any full or partial reduction in the availability of the Facility to produce and deliver to the Point of Interconnection electric energy in response to Company Dispatch which is caused by any Third Party including, without limitation, any vendor or supplier of Seller or Company, except to the extent due to Force Majeure.

21.4 Satisfaction of Certain Conditions. Section 21.5 (Guaranteed Project Milestones Including Commercial Operations), Section 21.6 (Events of Default) and Section 21.7 (Effect of Force Majeure) defer or limit certain liabilities of a Party for delay and/or failure in performance to the extent such delay or failure is the result of conditions or events of Force Majeure; provided, however, that a Non-performing Party is only entitled to such limitations or deferrals of liabilities as and to the extent the following conditions are satisfied:

- (a) the Non-performing Party gives the other Party, within 48 hours after the Force Majeure condition or event begins, written notice stating that the Non-performing Party considers such condition or event to constitute Force Majeure and describing the particulars of such Force Majeure condition or event;
- (b) the Non-performing Party gives the other Party, within 14 Days after the Force Majeure condition or event begins, a written explanation of the Force Majeure condition or event and its effect on the Non-performing Party's performance, which explanation shall include evidence reasonably sufficient to establish that the occurrence constitutes Force Majeure;
- (c) the suspension of performance is of no greater scope and of no longer duration than is required by the condition or event of Force Majeure;
- (d) the Non-performing Party proceeds with reasonable diligence to remedy its inability to perform and provides written weekly progress reports to the other Party describing actions taken to end the Force Majeure; and

(e) when the condition or event of Force Majeure ends and the Non-performing Party is able to resume performance of its obligations under this Agreement, that Party shall give the other Party written notice to that effect.

21.5 Guaranteed Project Milestones Including Commercial Operations. A condition or event of Force Majeure affecting the achievement of a Guaranteed Project Milestone Date, including the Guaranteed Commercial Operations Date, if and for so long as the conditions of Section 21.4 (Satisfaction of Certain Conditions) are satisfied, shall have the following effect: i) Company shall have the right to collect and Seller shall have the obligation to pay Daily Delay Damages as and to the extent set forth in Section 13.4(a) (Daily Delay Damages); (ii) Company shall have the right to terminate this Agreement as and to the extent set forth in Section 13.4(b) (Termination and Termination Damages for Failure to Achieve Guaranteed Project Milestones Date); and (iii) notwithstanding any provision herein to the contrary, upon Company's termination of this Agreement pursuant to Section 13.4(b) (Termination and Termination Damages for Failure to Achieve Guaranteed Project Milestones Date) neither Party shall be liable for any damages (including Termination Damages) nor have any obligations to the other, except as provided in Section 29.24 (Survival of Obligations), other than as provided in Section 29.24(b).

21.6 Events of Default. If Force Majeure delays or prevents a Party's performance for more than three hundred sixty-five (365) Days from the occurrence or inception of the Force Majeure, as noticed pursuant to Section 21.4(a), and such delay or failure of performance constitutes an Event of Default under Article 15 (Event of Default), the other Party shall have the right to terminate this Agreement by written notice. Such notice shall designate the date such termination is to be effective, which date shall be no later than thirty (30) Days after such notice is deemed to be received by the Party whose performance has been delayed or prevented. In the event of termination pursuant to this Section 21.6 (Events of Default), neither Party shall be liable for any damages or have any obligations to the other, except as provided in Section 29.25 (Survival of Obligations) other than as provided in Section 29.25(b).

21.7 Effect of Force Majeure. Other than as provided in Section 21.5 (Guaranteed Project Milestones Including Commercial

Operations) and Section 21.6 (Events of Default), neither Party shall be responsible or liable for any delays or failures in its performance under this Agreement as and to the extent (i) such delays or failures are substantially caused by conditions or events of Force Majeure, and (ii) the conditions of Section 21.4 (Satisfaction of Certain Conditions) are satisfied.

21.8 No Relief of Other Obligations. Except as otherwise expressly provided for in this Agreement, the existence of a condition or event of Force Majeure shall not relieve the Parties of their obligations under this Agreement (including, but not limited to, payment obligations) to the extent that performance of such obligations is not precluded by the condition or event of Force Majeure.

21.9 No Extension of the Term. In no event will any delay or failure of performance caused by any conditions or events of Force Majeure extend this Agreement beyond its stated Term.

ARTICLE 22
WARRANTIES AND REPRESENTATIONS

22.1 By the Parties. Both Company and Seller represent, warrant, and covenant, as of the Execution Date and for the extent of the Term, respectively, that:

- (a) Each respective Party has all necessary right, power and authority to execute, deliver and perform this Agreement
- (b) The execution, delivery and performance of this Agreement by each respective Party will not result in a violation of any Laws, or conflict with, or result in a breach of, or cause a default under, any agreement or instrument to which such Party is also a party or by which it is bound. No consent of any person or entity not a Party to this Agreement, including any Governmental Authority (other than the PUC and other agencies whose approval is necessary for construction of Company-Owned Interconnection Facilities), is required for such execution, delivery and performance by either Party.

22.2 By Seller. Seller represents, warrants, and covenants, as of the Execution Date and for the extent of the Term, that:

- (a) It is an entity in good standing with the Hawai'i Department of Commerce and Consumer Affairs and shall provide Company with a certified copy of a certificate of good standing by the Execution Date.
- (b) **[DRAFTING NOTE: ADD STATEMENT OF SELLER'S EXPERIENCE CONSISTENT WITH STATEMENTS MADE IN SELLER'S PROPOSAL IF APPLICABLE.]**
- (c) As of the Execution Date, Seller has obtained all Land Rights necessary for the construction, ownership, operation and maintenance of the Facility during the Initial Term, and Seller shall maintain such Land Rights in effect throughout the Term.
- (d) As of the commencement of construction, Seller shall have obtained (i) all Land Rights and Governmental Approvals necessary for the construction, ownership, operation and maintenance of the Company-Owned Interconnection Facilities and (ii) all Governmental

Approvals necessary for the construction, ownership, operation and maintenance of the Facility.

- (e) As of the Commercial Operations Date, the Facility will be a qualified renewable resource under RPS in effect as of the Effective Date.

ARTICLE 23
PROCESS FOR ADDRESSING
REVISIONS TO PERFORMANCE STANDARDS

- 23.1 Revisions to Performance Standards. The Parties acknowledge that, during the Term, certain Performance Standards may be revised or added to facilitate necessary improvements in integrating intermittent renewable energy resources into the Company System and operations. In particular, the following Performance Standards in Attachment B (Facility Owned by Seller) to this Agreement may be revised: Section 3(c) (Ramp Rates); and Section 3(m) (Frequency Response). Such revisions or additions may be attributable to, without limitation, the following: changes in penetration levels of intermittent renewable resources on the Company System, changes to the state of commercially available technology, changes to Company-owned generation resources, changes in customer electrical usage (such as changes in average hourly load profiles), and changes in Laws (e.g., new environmental constraints, which may limit Company's ability to start/stop its generators in response to integration of intermittent generation, or constraints impacting the power quality standards for the Company System, such as constraints imposed by HERA or by the PUC under the HERA Law).
- 23.2 Performance Standards Information Request. If Company concludes that a Performance Standards Revision is necessary or important for the operation of the Company System and is capable of being complied with by Seller, Company shall have the right to issue to Seller a Performance Standards Information Request with respect to such Performance Standards Revision. Seller shall, within a reasonable period of time following Seller's receipt of such Performance Standards Information Request, but in no event more than 90 Days after Seller's receipt of such Request (or such other period of time as Company and Seller may agree in writing), submit to Company a Performance Standards Proposal responsive to the Performance Standards Revision proposed in such Performance Standards Information Request.
- 23.3 Performance Standards Proposal. Upon receipt of a Performance Standards Proposal submitted in response to a Performance Standards Information Request, Company will evaluate such Performance Standards Proposal and Seller shall assist Company in performing such evaluation as and to the extent reasonably requested by Company (including, but not limited to, providing such additional information as

Company may reasonably request and participating in meetings with Company as Company may reasonably request). Company shall have no obligation to evaluate a Performance Standards Proposal submitted at Seller's own initiative.

23.4 Performance Standards Revision Document. If, following Company's evaluation of a Performance Standards Proposal, Company desires to consider implementing the Performance Standards Revision addressed in such Proposal, Company shall provide Seller with written notice to that effect, such notice to be issued to Seller within 180 Days of receipt of the Performance Standards Proposal, and Company and Seller shall proceed to negotiate in good faith a Performance Standards Revision Document setting forth the specific changes to the Agreement that are necessary to implement such Performance Standards Revision. A decision by Company to initiate negotiations with Seller as aforesaid shall not constitute an acceptance by Company of any of the details set forth in Seller's Performance Standards Proposal for the Performance Standards Revision in question, including but not limited to the Performance Standards Modifications and the Performance Standards Pricing Impact. Any adjustment to the Contract Pricing pursuant to such Performance Standards Revision Document shall be limited to the Performance Standards Pricing Impact (other than with respect to the financial consequences of non-performance as to a Performance Standards Revision). The time periods set forth in such Performance Standards Revision Document as to the effective date for the Performance Standards Revision shall be measured from the date the PUC Performance Standards Revision Order becomes non-appealable as provided in Section 23.6 (PUC Performance Standards Revision Order).

23.5 Failure to Reach Agreement. If Company and Seller are unable to agree upon and execute a Performance Standards Revision Document within 180 Days of Company's written notice to Seller pursuant to Section 23.4 (Performance Standards Revision Document), Company shall have the option of declaring the failure to reach agreement on and execute such Performance Standards Revision Document to be a dispute and submit such dispute to an Independent Evaluator for the conduct of a determination pursuant to Section 23.10 (Dispute) of this Agreement. Any decision of the Independent Evaluator, rendered as a result of such dispute shall include a form of a Performance Standards Revision Document as described in Section 23.4 (Performance Standards Revision Document).

- 23.6 PUC Performance Standards Revision Order. No Performance Standards Revision Document shall constitute an amendment to the Agreement unless and until a PUC Performance Standards Revision Order issued with respect to such Document has become non-appealable. Once the condition of the preceding sentence has been satisfied, such Performance Standards Revision Document shall constitute an amendment to this Agreement. To be "non-appealable" under this Section 23.6 (PUC Performance Standards Revision Order), such PUC Performance Standards Revision Order shall be either (i) not subject to appeal to any Circuit Court of the State of Hawai'i or the Supreme Court of the State of Hawai'i, because the thirty (30) Day period (accounting for weekends and holidays as appropriate) permitted for such an appeal has passed without the filing of notice of such an appeal, or (ii) affirmed on appeal to any Circuit Court of the State of Hawai'i or the Supreme Court, or the Intermediate Appellate Court upon assignment by the Supreme Court, of the State of Hawai'i, or affirmed upon further appeal or appellate process, and is not subject to further appeal, because the jurisdictional time permitted for such an appeal (and/or further appellate process such as a motion for reconsideration or an application for writ of certiorari) has passed without the filing of notice of such an appeal (or the filing for further appellate process).
- 23.7 Company's Rights. The rights granted to Company under Section 23.4 (Performance Standards Revision Document) and Section 23.5 (Failure to Reach Agreement) above are exclusive to Company. Seller shall not have a right to initiate negotiations of a Performance Standards Revision Document or to initiate dispute resolution under Section 23.10 (Dispute), as a result of a failure to agree upon and execute any Performance Standards Revision Document.
- 23.8 Seller's Obligation. Notwithstanding any provision of this Article 23 (Process for Addressing Revisions to Performance Standards) to the contrary, Seller shall have no obligation to respond to more than one Performance Standards Information Request during any 12-month period.
- 23.9 Limited Purpose. This Article 23 (Process for Addressing Revisions to Performance Standards) is intended to specifically address necessary revisions to the Performance Standards to enhance integration of intermittent resources onto Company System, or to comply with future Laws which may be driven in part by higher integration of intermittent

resources, and is not intended for either Party to provide a means for renegotiating any other terms of this Agreement. Revisions to the Performance Standards in accordance with the provisions of this Article 23 (Process for Addressing Revisions to Performance Standards) are not intended to materially increase Seller's risk of non-performance or default.

23.10 Dispute. If Company decides to declare a dispute as a result of the failure to reach agreement and execute a Performance Standards Revision Document pursuant to Section 23.5 (Failure to Reach Agreement), it shall provide written notice to that effect to Seller. Within 20 Days of delivery of such notice Seller and Company shall agree upon an Independent Evaluator to resolve the dispute regarding a Performance Standards Revision Document. The Independent Evaluator shall be reasonably qualified and expert in renewable energy power generation, matters relating to the Performance Standards, financing, and power purchase agreements. If the Parties are unable to agree upon an Independent Evaluator within such 20-Day period, Company shall apply to the PUC for the appointment of an Independent Evaluator. If an Independent Observer retained under the Competitive Bidding Framework is qualified and willing and available to serve as Independent Evaluator, the PUC shall appoint one of the persons or entities qualified to serve as an Independent Observer to be the Independent Evaluator; if not, the PUC shall appoint another qualified person or entity to serve as Independent Evaluator. In its application, Company shall ask the PUC to appoint an Independent Evaluator within 30 Days of the application.

(a) Promptly upon appointment, the Independent Evaluator shall request the Parties to address the following matters within the next 15 Days:

- (1) The Performance Standard Revision(s);
- (2) The technical feasibility of complying with the Performance Standard Revision(s) and likelihood of compliance;
- (3) How Seller would comply with the Performance Standard Revision(s);

- (4) Reasonably expected net costs and/or lost revenues associated with the Performance Standards Revision(s);
 - (5) The appropriate level, if any, of Performance Standards Pricing Impact in light of the foregoing; and
 - (6) Contractual consequences for non-performance that are commercially reasonable under the circumstances.
- (b) Within 90 Days of appointment, the Independent Evaluator shall render a decision unless the Independent Evaluator determines it needs to have additional time, not to exceed 45 Days, to render a decision.
 - (c) The Parties shall assist the Independent Evaluator throughout the process of preparing its review, including making key personnel and records available to the Independent Evaluator, but neither Party shall be entitled to participate in any meetings with personnel of the other Party or review of the other Party's records. However, the Independent Evaluator will have the right to conduct meetings, hearings or oral arguments in which both Parties are represented. The Parties may meet with each other during the review process to explore means of resolving the matter on mutually acceptable terms.
 - (d) The following standards shall be applied by the Independent Evaluator in rendering his or her decision: (i) if it is not technically or operationally feasible for Seller to comply with a Performance Standard Revision, the Independent Evaluator shall determine that the Agreement shall not be amended to incorporate such Performance Standard Revision (unless the Parties agree otherwise); (ii) if it is technically or operationally feasible for Seller to comply with a Performance Standard Revision, the Independent Evaluator shall incorporate such Performance Standard Revision into a Performance Standards Revision Document including (aa) Seller's Performance Standards Modifications, (bb) pricing terms that incorporate the Performance Standards Pricing Impact, and (cc) contract terms and conditions

that are commercially reasonable under the circumstances, especially with respect to the consequences of non-performance by Seller as to Performance Standards Revision(s). In addition to the Performance Standards Revision Document, the Independent Evaluator shall render a decision which sets forth the positions of the Parties and Independent Evaluator's rationale for his or her decisions on disputed issues.

- (e) The fees and costs of the Independent Evaluator shall be paid by Company up to the first \$30,000 of such fees and costs; above those amounts, the Party that is not the prevailing Party shall be responsible for any such fees and costs; provided, if neither Party is the prevailing Party, then the fees and costs of the Independent Evaluator above \$30,000, shall be borne equally by the Parties. The Independent Evaluator in rendering his or her decision shall also state which Party prevailed over the other Party, or that neither Party prevailed over the other.

23.11 HERA Law. The provisions of this Article 23 (Process for Addressing Revisions to Performance Standards) are without limitation to the obligations of the Parties under the HERA Law and the reliability standards and interconnection requirements developed and adopted by the PUC pursuant to the HERA Law.

ARTICLE 24
FINANCIAL COMPLIANCE

- 24.1 Financial Compliance. Seller shall provide or cause to be provided to Company on a timely basis, as reasonably determined by Company, all information, including but not limited to information that may be obtained in any audit referred to below (the "Financial Compliance Information"), reasonably requested by Company for purposes of permitting Company and its parent company, HEI, to comply with the requirements (initial and on-going) of (i) the accounting principles of Financial Accounting Standards Board ("FASB") Accounting Standards Codification 810, Consolidation ("FASB ASC 810"), (ii) Section 404 of the Sarbanes-Oxley Act of 2002 ("SOX 404"), (iii) FASB ASC 840 Leases ("FASB ASC 840"), and (iv) all clarifications, interpretations and revisions of and regulations implementing FASB ASC 810, SOX 404 and FASB ASC 840, issued by the FASB, Securities and Exchange Commission, the Public Company Accounting Oversight Board, Emerging Issues Task Force or other Governmental Authorities. In addition, if required by Company in order to meet its compliance obligations, Seller shall allow Company or its independent auditor to audit, to the extent reasonably required, Seller's financial records, including its system of internal controls over financial reporting; provided, however, that Company shall be responsible for all costs associated with the foregoing, including but not limited to Seller's reasonable internal costs. Company shall limit access to such Financial Compliance Information to persons involved with such compliance matters and restrict persons involved in Company's monitoring, dispatch or scheduling of Seller and/or Facility, or the administration of this Agreement, from having access to such Financial Compliance Information (unless approved in writing in advance by Seller).
- 24.2 Confidentiality. Company shall, and shall cause HEI to, maintain the confidentiality of the Financial Compliance Information as provided in this Article 24 (Financial Compliance). Company may share the Information on a confidential basis with HEI and the independent auditors and attorneys for HEI. (Company, HEI, and their respective independent auditors and attorneys are collectively referred to in this Article 24 (Financial Compliance) as "Recipient".) If either Company or HEI, in the exercise of their respective reasonable judgments, concludes that consolidation or financial reporting with respect to Seller

and/or this Agreement is necessary, Company and HEI each shall have the right to disclose such of the Financial Compliance Information as Company or HEI, as applicable, reasonably determines is necessary to satisfy applicable disclosure and reporting or other requirements and give Seller prompt written notice thereof (in advance to the extent practicable under the circumstances). If Company or HEI disclose Financial Compliance Information pursuant to the preceding sentence, Company and HEI shall, without limitation to the generality of the preceding sentence, have the right to disclose Financial Compliance Information to the PUC and the Division of Consumer Advocacy of the Department of Commerce and Consumer Affairs of the State of Hawai'i ("Consumer Advocate") in connection with the PUC's rate making activities for Company and other HEI affiliated entities, provided that, if the scope or content of the Financial Compliance Information to be disclosed to the PUC exceeds or is more detailed than that disclosed pursuant to the preceding sentence, such Financial Compliance Information will not be disclosed until the PUC first issues a protective order to protect the confidentiality of such Financial Compliance Information. Neither Company nor HEI shall use the Financial Compliance Information for any purpose other than as permitted under this Article 24 (Financial Compliance).

- 24.3 Required Disclosure. In circumstances other than those addressed in Section 24.2 (Confidentiality), if any Recipient becomes legally compelled under applicable Laws or by legal process (e.g., deposition, interrogatory, request for documents, subpoena, civil investigative demand or similar process) to disclose all or a portion of the Financial Compliance Information, such Recipient shall undertake reasonable efforts to provide Seller with prompt notice of such legal requirement prior to disclosure so that Seller may seek a protective order or other appropriate remedy and/or waive compliance with the terms of this Article 24 (Financial Compliance). If such protective order or other remedy is not obtained, or if Seller waives compliance with the provisions at this Article 24 (Financial Compliance), Recipient shall furnish only that portion of the Financial Compliance Information which it is legally required to so furnish and to use reasonable efforts to obtain assurance that confidential treatment will be accorded to any disclosed material.

- 24.4 Exclusions from Confidentiality. The obligation of nondisclosure and restricted use imposed on each Recipient under this Article 24 (Financial Compliance) shall not extend to any portion(s) of the Financial Compliance Information which (i) was known to such Recipient prior to receipt, or (ii) without the fault of such Recipient is available or becomes available to the general public, or (iii) is received by such Recipient from a Third Party not bound by an obligation or duty of confidentiality.
- 24.5 Consolidation and Lease. Company does not want to be subject to consolidation and capital lease treatment as set forth in FASB ASC 810 and 840, respectively, as issued and amended from time to time by FASB. Company also does not want to be subject to lease treatment as set forth in FASB Accounting Standards Codification 842, Leases, effective January 1, 2019 ("FASB ASC 842").
- (a) Consolidation. Company represents that, as of the Execution Date, it is not required to consolidate Seller into its financial statements in accordance with FASB ASC 810. If for any reason, at any time during the Term, Company determines, in its sole but good faith discretion, that it is required to consolidate Seller into its financial statements in accordance with FASB ASC 810, then Seller shall immediately provide audited financial statements (including footnotes) in accordance with U.S. generally accepted accounting principles (and as of the reporting periods Company is required to report thereafter) in order for Company to consolidate and file its financial statements within the reporting deadlines of the Securities and Exchange Commission; provided, however, that if Seller does not normally prepare audited financial statements for the periods requested, Company shall reimburse Seller fifty percent (50%) of the reasonable costs of having necessary audits performed and preparation of the audited financial statement; provided, further that the foregoing reimbursement shall only apply if Seller normally prepares financial statements on an annual basis. Notwithstanding the foregoing requirement that Seller provide audited financial statements to Company, the Parties will take all commercially reasonable steps, which may include modification of this Agreement to eliminate the consolidation treatment, while preserving the economic "benefit of

the bargain" to both Parties, or, if the Parties are unable to eliminate the consolidation treatment by other means, effectuating a sale of the Facility to Company at (i) if the sale occurs before the end of the thirteenth (13th) Contract Year, the greater of the Make Whole Amount determined pursuant to Section 6 (Make Whole Amount) of Attachment P (Sale of Facility of Seller) or the fair market value determined pursuant to Section 3 (Procedure to Determine Fair Market Value of the Facility) of Attachment P (Sale of Facility by Seller), or (ii) if the sale occurs on or after the beginning of the fourteenth (14th) Contract Year, the fair market value determined pursuant to Section 3 (Procedure to Determine Fair Market Value of the Facility) of Attachment P (Sale of Facility by Seller), but not less than the Financial Termination Costs determined pursuant to Section 6 (Make Whole Amount) of Attachment P (Sale of Facility by Seller), in either case under a Purchase and Sale Agreement to be negotiated based on the terms and conditions set forth in Section 4 (Purchase and Sale Agreement) of Attachment P (Sale of Facility by Seller).

- (b) Capital Lease. Company represents that, as of the Execution Date, it is not required to treat this Agreement as a capital lease. If there is a change in circumstances during the Term that would trigger capital lease treatment as of the Execution Date, and such capital lease treatment is not attributable to Company's fault, then the Parties will take all commercially reasonable steps, which may include modification of the Agreement to eliminate the capital lease treatment, while preserving the economic "benefit of the bargain" to both Parties, or, if the Parties are unable to eliminate the capital lease treatment by other means, effectuating a sale of the Facility to Company at (i) if the sale occurs before the end of the thirteenth (13th) Contract Year, the greater of the Make Whole Amount determined pursuant to Section 6 (Make Whole Amount) of Attachment P (Sale of Facility of Seller) or the fair market value determined pursuant to Section 3 (Procedure to Determine Fair Market Value of the Facility) of Attachment P (Sale of Facility by Seller) or (ii) if the sale occurs on or after the beginning of the fourteenth (14th) Contract Year, the fair market value determined pursuant to Section 3 (Procedure to

Determine Fair Market Value of the Facility) of Attachment P (Sale of Facility by Seller), but not less than the Financial Termination Costs determined pursuant to Section 6 (Make Whole Amount) of Attachment P (Sale of Facility by Seller), in either case under a Purchase and Sale Agreement to be negotiated based on the terms and conditions set forth in Section 4 (Purchase and Sale Agreement) of Attachment P (Sale of Facility by Seller).

- (c) Lease. Under FASB ASC 842, finance and operating leases will be reflected on the Company's balance sheet. If there is a change in circumstances during the Term that would trigger lease treatment, and such lease treatment is not attributable to Company's fault, then the Parties will take all commercially reasonable steps, which may include modification of the Agreement, to eliminate the lease treatment, while preserving the economic "benefit of the bargain" to both Parties, or, if the Parties are unable to eliminate the lease treatment by other means, effectuating a sale of the Facility to Company at (i) if the sale occurs before the end of the thirteenth (13th) Contract Year, the greater of the Make Whole Amount determined pursuant to Section 6 (Make Whole Amount) of Attachment P (Sale of Facility of Seller) or the fair market value determined pursuant to Section 3 (Procedure to Determine Fair Market Value of the Facility) of Attachment P (Sale of Facility by Seller) or (ii) if the sale occurs on or after the beginning of the fourteenth (14th) Contract Year, the fair market value determined pursuant to Section 3 (Procedure to Determine Fair Market Value of the Facility) of Attachment P (Sale of Facility by Seller), but not less than the Financial Termination Costs determined pursuant to Section 6 (Make Whole Amount) of Attachment P (Sale of Facility by Seller), in either case under a Purchase and Sale Agreement to be negotiated based on the terms and conditions set forth in Section 4 (Purchase and Sale Agreement) of Attachment P (Sale of Facility by Seller).

ARTICLE 25
GOOD ENGINEERING AND OPERATING PRACTICES

- 25.1 General. Each Party agrees to install, operate and maintain its respective equipment and facility and to perform all obligations required to be performed by such Party under this Agreement in accordance with Good Engineering and Operating Practices and applicable Laws.
- 25.2 Specifications, Determinations and Approvals. Wherever in this Agreement Company has the right to give specifications, determinations or approvals, such specifications, determinations or approvals shall be given in accordance with Company's standard practices, policies and procedures and shall not be unreasonably withheld.
- 25.3 No Endorsement, Warranty or Waiver. Any such specifications, determinations, or approvals shall not be deemed to be an endorsement, warranty, or waiver of any right of Company.
- 25.4 Consultants List. Prior to the Commercial Operations Date, the Parties shall agree on a list of names of engineering firms to be attached as Attachment D (Consultants List) in accordance with Section 4 (Maintenance of Seller-Owned Interconnection Facilities) of Attachment B (Facility Owned By Seller).

ARTICLE 26
EQUAL EMPLOYMENT OPPORTUNITY

- 26.1 Equal Employment Opportunity. (Applicable to all contracts of \$10,000 or more in the whole or aggregate. 41 CFR 60-1.4 and 41 CFR 60-741.5.) Seller is aware of and is fully informed of Seller's responsibilities under Executive Order 11246 (reference to which include amendments and orders superseding in whole or in part) and shall be bound by and agrees to the applicable provisions as contained in Section 202 of said Executive Order and the Equal Opportunity Clause as set forth in 41 CFR 60-1.4 and 41 CFR 60-741.5(a), which clauses are hereby incorporated by reference.
- 26.2 Equal Opportunity For Disabled Veterans, Recently Separated Veterans, Other Protected Veterans and Armed Forces Service Medal Veterans. Applicable to (i) contracts of \$25,000 or more entered into before December 31, 2003 (41 CFR 60-250.4) or (ii) each federal government contract of \$100,000 or more, entered into or modified on or after December 31, 2003 (41 CFR 60-300.4) for the purchase, sale or use of personal property or nonpersonal services (including construction.) If applicable to Seller under this Agreement, Seller agrees that is, and shall remain, in compliance with the rules and regulations promulgated under The Vietnam Era Veterans Readjustment Assistance Act of 1974, as amended by the Jobs for Veterans Act of 2002, including the requirements of 41 CFC 60-250.5(a) (for orders/contracts entered into before December 31, 2003) and 41 CFR 60-300.5(a) (for orders/contracts entered into or modified on or after December 31, 2003) which are incorporated into this Agreement by reference.

ARTICLE 27
SET OFF

Company shall have the right to set off any payment due and owing by Seller, including but not limited to any payment under this Agreement and any payment due under any award made under Article 28 (Dispute Resolution), against Company's payments of subsequent monthly invoices as necessary.

ARTICLE 28
DISPUTE RESOLUTION

- 28.1 Good Faith Negotiations. Except as otherwise expressly set forth in this Agreement, before submitting any claims, controversies or disputes ("Dispute(s)") under this Agreement to the Dispute Resolution Procedures set forth in Section 28.2 (Dispute Resolution Procedures, Mediation), the presidents, vice presidents, or authorized delegates from both Seller and Company having full authority to settle the Dispute(s), shall personally meet in Hawai'i and attempt in good faith to resolve the Dispute(s) (the "Management Meeting").
- 28.2 Dispute Resolutions Procedures, Mediation. Except as otherwise expressly set forth in this Agreement and subject to Section 28.1 (Good Faith Negotiations), any and all Dispute(s) arising out of or relating to this Agreement, (i) which remain unresolved for a period of 20 Days after the Management Meeting takes place or (ii) for which the Parties fail to hold a Management Meeting within 60 Days of the date that a Management Meeting was requested by a Party, may upon the agreement of the Parties, first be submitted to confidential mediation in Honolulu, Hawai'i pursuant to the administration by, and in accordance with the Mediation Rules, Procedures and Protocols of, Dispute Prevention & Resolution, Inc. (or its successor) or, in their absence, the American Arbitration Association ("DPR") then in effect. If the Parties agree to submit the dispute to confidential mediation, the parties shall each pay 50% of the cost of the mediation (i.e., the fees and expenses charged by the mediator and DPR) and shall otherwise each bear their own mediation costs and attorneys' fees. If the Parties do not submit the Dispute(s) to mediation, or if they do submit the Dispute(s) to mediation but settlement of the Dispute(s) is not reached within 60 Days after commencement of the mediation, either Party may initiate legal proceedings in a court of competent jurisdiction in the State of Hawai'i.
- 28.3 Exclusions. The provisions of this Article 28 (Dispute Resolution) shall not apply to any disputes within the authority of any of (i) an Independent Evaluator under Article 23 (Process for Addressing Revisions to Performance Standards), (ii) an Independent AF Evaluator under Attachment T (Monthly Reporting and Dispute Resolution by Independent AF Evaluator) or (iii) an OEPR Evaluator under

Attachment U (Calculation and Adjustment of Net Energy Potential).

ARTICLE 29
MISCELLANEOUS

29.1 Amendments. Any amendment or modification of this Agreement or any part hereof shall not be valid unless in writing and signed via manual signature by the Parties. Any waiver hereunder shall not be valid unless in writing and signed via manual signature by the Party against whom waiver is asserted. Notwithstanding the foregoing, administrative changes mutually agreed by Company and Seller in writing, such as changes to settings shown in the Single-Line Drawing and Interface Block Diagram (Attachment E) and the Relay List and Trip Scheme (Attachment F) and changes to numerical values of Performance Standards in Section 3 (Performance Standards) of Attachment B (Facility Owned by Company) shall not be considered amendments to this Agreement requiring PUC approval.

29.2 Binding Effect. This Agreement shall be binding upon and inure to the benefit of the Parties hereto and their respective successors, legal representatives, and permitted assigns.

29.3 Notices.

- (a) All notices, consents and waivers under this Agreement shall be in writing and will be deemed to have been duly given when (i) delivered by hand, (ii) sent by electronic mail ("E-mail") (provided receipt thereof is confirmed via E-mail or in writing by recipient), (iii) sent by certified mail, return receipt requested, or (iv) when received by the addressee, if sent by a nationally recognized overnight delivery service (receipt requested), in each case to the appropriate addresses and E-mail Addresses set forth below (or to such other addresses and E-mail addresses as a Party may designate by notice to the other Party):

Company:

By Mail:

Hawaiian Electric Company, Inc.
P.O. Box 2750
Honolulu, Hawai'i 96840
Attn: Director Energy Procurement

Delivered By Hand or Overnight Delivery:

Hawaiian Electric Company, Inc.
Central Pacific Plaza
220 South King Street, Suite 2100
Honolulu, Hawai'i 96813
Attn: Director Energy Procurement

By facsimile-mail:

Hawaiian Electric Company, Inc.
Attn: Director Energy Procurement
Email: ppanotices@hawaiianelectric.com

With a copy to:

By Mail:

Hawaiian Electric Company, Inc.
Legal Department
P.O. Box 2750
Honolulu, Hawai'i 96840

By E-mail:

Hawaiian Electric Company, Inc.
Legal Department
Email: legalnotices@hawaiianelectric.com

Seller: The contact information listed in Attachment A (Description of Generation and Conversion Facility) hereto.

- (b) Notice sent by mail shall be deemed to have been given on the date of actual delivery or at the expiration of the fifth Day after the date of mailing, whichever is earlier. Any Party hereto may change its address for written notice by giving written notice of such change to the other Party hereto.
- (c) Any notice delivered by E-mail shall request a receipt thereof confirmed by E-mail or in writing by the recipient and followed by personal or mail delivery of such correspondence any attachments as may be requested by the recipient, and the effective date of such notice shall be the date of receipt, provided such receipt has been confirmed by the recipient.
- (d) The Parties may agree in writing upon additional means of providing notices, consents and waivers under this

Agreement in order to adapt to changing technology and commercial practices.

- 29.4 Effect of Section and Attachment Headings. The Table of Contents and paragraph headings of the various sections and attachments have been inserted in this Agreement as a matter of convenience for reference only and shall not modify, define or limit any of the terms or provisions hereof and shall not be used in the interpretation of any term or provision of this Agreement.
- 29.5 Non-Waiver. Except as otherwise provided in this Agreement, no delay or forbearance of Company or Seller in the exercise of any remedy or right will constitute a waiver thereof, and the exercise or partial exercise of a remedy or right shall not preclude further exercise of the same or any other remedy or right.
- 29.6 Relationship of the Parties. Nothing in this Agreement shall be deemed to constitute either Party hereto as partner, agent or representative of the other Party or to create any fiduciary relationship between the Parties. Seller does not hereby dedicate any part of Facility to serve Company, Company's customers or the public.
- 29.7 Entire Agreement. This Agreement (together with any confidentiality or non-disclosure agreements entered into by the Parties during the process of negotiating this Agreement and/or discussing the specifications of the Facility) constitutes the entire agreement between the Parties relating to the subject matter hereof, superseding all prior agreements, understandings or undertakings, oral or written. Each of the Parties confirms that in entering into this Agreement, it has not relied on any statement, warranty or other representations (other than those set out in this Agreement) made or information supplied by or on behalf of the other Party.
- 29.8 Governing Law, Jurisdiction and Venue. Interpretation and performance of this Agreement shall be in accordance with, and shall be controlled by, the laws of the State of Hawai'i, other than the laws thereof that would require reference to the laws of any other jurisdiction. By entering into this Agreement, Seller submits itself to the personal jurisdiction of the courts of the State of Hawai'i and agrees that the proper venue for any civil action

arising out of or relating to this Agreement shall be Honolulu, Hawai'i.

- 29.9 Limitations. Nothing in this Agreement shall limit Company's ability to exercise its rights as specified in Company's Tariff as filed with the PUC, or as specified in General Order No. 7 of the PUC's Standards for Electric Utility Service in the State of Hawai'i, as either may be amended from time to time.
- 29.10 Further Assurances. If either Party determines in its reasonable discretion that any further instruments, assurances or other things are necessary or desirable to carry out the terms of this Agreement, the other Party will execute and deliver all such instruments and assurances and do all things reasonably necessary or desirable to carry out the terms of this Agreement.
- 29.11 Electronic Signatures and Counterparts. The parties agree that this Agreement and any subsequent writings, including amendments, may be executed and delivered by exchange of executed copies via E-mail or other acceptable electronic means, and in electronic formats such as Adobe PDF or other formats mutually agreeable between the parties which preserve the final terms of this Agreement or such writing. A party's signature transmitted by facsimile, E-mail, or other acceptable electronic means shall be considered an "original" signature which is binding and effective for all purposes of this Agreement. This Agreement may be executed in counterparts, each of which shall be deemed an original, and all of which shall together constitute one and the same instrument binding all Parties notwithstanding that all of the Parties are not signatories to the same counterparts. For all purposes, duplicate unexecuted and unacknowledged pages of the counterparts may be discarded and the remaining pages assembled as one document.
- 29.12 Definitions. Capitalized terms used in this Agreement and not otherwise defined in the context in which they first appear are defined in the Definitions Section.
- 29.13 Severability. If any term or provision of this Agreement, or the application thereof to any person, entity or circumstances is to any extent invalid or unenforceable, the remainder of this Agreement, or the application of such term or provision to persons, entities or circumstances other than those as to which it is invalid or unenforceable, shall

not be affected thereby, and each term and provision of this Agreement shall be valid and enforceable to the fullest extent permitted by law, and the Parties will take all commercially reasonable steps, including modification of the Agreement, to preserve the economic "benefit of the bargain" to both Parties notwithstanding any such aforesaid invalidity or unenforceability.

- 29.14 Settlement of Disputes. Except as otherwise expressly provided, any dispute or difference arising out of this Agreement or concerning the performance or the non-performance by either Party of its obligations under this Agreement shall be determined in accordance with the dispute resolution procedures set forth in Article 28 (Dispute Resolution) of this Agreement.
- 29.15 Environmental Credits and RPS. To the extent not prohibited by law, Company shall have the sole and exclusive right to use the electric energy purchased hereunder to meet RPS and any Environmental Credit shall be the property of Company; provided, however, that such Environmental Credits shall be to the benefit of Company's ratepayers in that the value must be credited "above the line". Seller shall use all commercially reasonable efforts to ensure such Environmental Credits are vested in Company, and shall execute all documents, including, but not limited to, documents transferring such Environmental Credits, without further compensation; provided, however, that Company agrees to pay for all reasonable costs associated with such efforts and/or documentation.
- 29.16 Schedule of Defined Terms and Attachments. The Schedule of Defined Terms and each Attachment to this Agreement constitute essential and necessary parts of this Agreement.
- 29.17 Proprietary Rights. Seller agrees that in fulfilling its responsibilities under this Agreement, it will not use any process, program, design, device or material that infringes on any United States patent, trademark, copyright or trade secret ("Proprietary Rights"). Seller agrees to indemnify, defend and hold harmless the Indemnified Company Party from and against all losses, damages, claims, fees and costs, including but not limited to reasonable attorneys' fees and costs, arising from or incidental to any suit or proceeding brought against the Indemnified Company Party for infringement of Third Party Proprietary Rights arising out of Seller's performance under this Agreement, including but

not limited to patent infringement due to the use of technical features of the Facility to meet the Performance Standards specified in the Agreement.

29.18 Negotiated Terms. The Parties agree that the terms and conditions of this Agreement are the result of negotiations between the Parties and that this Agreement shall not be construed in favor of or against any Party by reason of the extent to which any Party or its professional advisors participated in the preparation of this Agreement.

29.19 Computation of Time. In computing any period of time prescribed or allowed under this Agreement, the Day of the act, event or default from which the designated period of time begins to run shall not be included. If the last Day of the period so computed is not a Business Day, then the period shall run until the end of the next Day which is a Business Day.

29.20 PUC Approval.

(a) PUC Approval Order. The term "PUC Approval Order" means an order from the PUC that does not contain terms and conditions deemed to be unacceptable by Company, and is in a form deemed to be reasonable by Company, in its sole, but nonarbitrary, discretion, ordering that:

- (1) this Agreement is approved;
- (2) Company is authorized to include the purchased energy costs (and related revenue taxes) that Company incurs under this Agreement in Company's Energy Cost Adjustment Clause, to the extent such costs are not included in Base Rates for the Term;
- (3) Company is authorized to include the Lump Sum Payment that Company incurs under this Agreement in Company's Purchase Power Adjustment Clause, to the extent such costs are not included in Base Rates for the Term;
- (4) the purchased energy costs and the Lump Sum Payment to be incurred by Company as a result of this Agreement are reasonable; and
- (5) Company's purchased power arrangements under this Agreement, pursuant to which Company will purchase

energy and Renewable Dispatchable Generation from Seller, are prudent and in the public interest.

- (b) Non-appealable PUC Approval Order. The term "Non-appealable PUC Approval Order" means a PUC Approval Order (i) that is not subject to appeal to any Circuit Court of the State of Hawai'i, Intermediate Court of Appeals of the State of Hawai'i, or the Supreme Court of the State of Hawai'i, because the period permitted for such an appeal (the "Appeal Period") has passed without the filing of notice of such an appeal, or (ii) that was affirmed on appeal to any Circuit Court of the State of Hawai'i, Intermediate Court of Appeals of the State of Hawai'i, or the Supreme Court of the State of Hawai'i, or was affirmed upon further appeal or appellate process, and that is not subject to further appeal, because the jurisdictional time permitted for such an appeal and/or further appellate process such as a motion for reconsideration or an application for writ of certiorari has passed without the filing of notice of such an appeal or the filing for further appellate process.
- (c) Company's Written Statement. Not later than thirty (30) Days after the issuance of a PUC order approving this Agreement, Company shall provide Seller with a copy of such order together with a written statement as to whether the conditions set forth in Section 29.20(a) (PUC Approval Order) have been met and the order constitutes a PUC Approval Order. If Company's written statement declares that the conditions set forth in Section 29.20(a) (PUC Approval Order) have been satisfied, the date of the issuance of the PUC Approval Order shall be the "PUC Approval Order Date".
- (d) Non-appealable PUC Approval Order Date. If Company provides the written statement referred to in Section 29.20(c) (Company's Written Statement) to the effect that the conditions referred to in Section 29.20(a) (PUC Approval Order) have been satisfied, the term "Non-appealable PUC Approval Order Date" shall be defined as follows:
- (1) If a PUC Approval Order is issued and is not made subject to a motion for reconsideration filed with the PUC or an appeal, the Non-appealable PUC Approval Order Date shall be the date one Day

after the expiration of Appeal Period following the issuance of the PUC Approval Order;

- (2) If the PUC Approval Order became subject to a motion for reconsideration, and the motion for reconsideration is denied or the PUC Approval Order is affirmed after reconsideration, and such order is not made subject to an appeal, the Non-appealable PUC Approval Order Date shall be deemed to be the date one Day after the expiration of the Appeal Period following the order denying reconsideration of or affirming the PUC Approval Order; or
- (3) If the PUC Approval Order, or an order denying reconsideration of the PUC Approval Order or affirming approval of the PUC Approval Order after reconsideration, becomes subject to an appeal, then the Non-appealable PUC Approval Order Date shall be the date upon which the PUC Approval Order becomes a non-appealable order within the meaning of the definition of a Non-Appealable PUC Approval Order in Section 29.20(b) (Non-appealable PUC Approval Order).

- (e) Unfavorable PUC Order. The term "Unfavorable PUC Order" means an order from the PUC concerning this Agreement that: (i) dismisses Company's application; (ii) denies Company's application; or (iii) approves Company's application but contains terms and conditions deemed unacceptable by Company in its sole discretion and therefore does not meet the definition of a PUC Approval Order as set forth in Section 29.20(a) (PUC Approval Order).

29.21 Community Outreach Plan. Seller has initiated, or has plans to initiate, discussions and/or informational sessions with community and neighborhood groups in and around the vicinity of the Facility to inform the neighboring public and community about the Facility and to gather information regarding neighboring public and community concerns regarding the Facility. Seller shall formulate and implement a community outreach plan no later than the PUC Submittal Date and provide a copy of such plan to Company upon its finalization and before implementation. The purpose and scope of such plan shall be in Seller's discretion, provided, however, that any such plan shall, at

a minimum, include provisions to inform the neighboring community, allay concerns, and implement, where commercially reasonable and possible, requests from the community to garner support for the Facility from the neighboring community.

29.22 Change in Standard System or Organization.

(a) Consistent With Original Intent. If, during the Term, any standard, system or organization referenced in this Agreement should be modified or replaced in the normal course of events, such modification or replacement shall from that point in time be used in this Agreement in place of the original standard, system or organization, but only to the extent such modification or replacement is generally consistent with the original spirit and intent of this Agreement.

(b) Eliminated or Inconsistent With Original Intent. If, during the Term, any standard system or organization referenced in this Agreement should be eliminated or cease to exist, or is modified or replaced and such modification or replacement is inconsistent with the original spirit and intent of this Agreement, then in such event the Parties will negotiate in good faith to amend this Agreement to a standard, system or organization that would be consistent with the original spirit and intent of this Agreement.

29.23 No Third Party Beneficiaries. Nothing expressed or referred to in this Agreement will be construed to give any person or entity other than the Parties any legal or equitable right, remedy, or claim under or with respect to this Agreement or any provision of this Agreement. This Agreement and all of its provisions and conditions are for the sole and exclusive benefit of the Parties and their successors and permitted assigns.

29.24 Hawai'i General Excise Tax. Seller shall, when making payments to Company under this Agreement, pay such additional amount as may be necessary to reimburse Company for the Hawai'i general excise tax on gross income and all other similar taxes imposed on Company by any Governmental Authority with respect to payments in the nature of gross receipts tax, sales tax, privilege tax or the like (including receipt of any payment made under this Section 29.24 (Hawai'i General Excise Tax)), but excluding federal

or state net income taxes. By way of example and not limitation, as of the Execution Date, all payments subject to the 4.5% Hawai'i general excise tax on O'ahu would include an additional 4.712% so that the underlying payment will be net of such tax liability.

29.25 Survival of Obligations. The rights and obligations that are intended to survive a termination of this Agreement are all of those rights and obligations that this Agreement expressly provides shall survive any such termination and those that arise from Seller's or Company's covenants, agreements, representations, and warranties applicable to, or to be performed, at or during any time prior to or as a result of the termination of this Agreement, including, without limitation:

- (a) The obligation to pay Daily Delay Damages under Section 13.4 (Damages and Termination);
- (b) The obligation to pay Termination Damages under Article 16 (Damages in the Event of Termination by Company);
- (c) The indemnity obligations under Article 17 (Indemnification) and Section 29.17 (Proprietary Rights);
- (d) The dispute resolution provisions of Article 28 (Dispute Resolution);
- (e) Section 29.3 (Notices), Section 29.5 (Non-Waiver), Section 29.8 (Governing Law, Jurisdiction and Venue), Section 29.9 (Limitations), Section 29.13 (Severability), Section 29.14 (Settlement of Disputes), Section 29.15 (Environmental Credits and RPS), Section 29.17 (Proprietary Rights), Section 29.19 (Computation of Time), Section 29.23 (No Third Party Beneficiaries), Section 29.24 (Hawai'i General Excise Tax), Section 29.25 (Survival of Obligations), Section 7 (Land Restoration) of Attachment G (Company-Owned Interconnection Facilities) and Section 1(d) (Right of First Refusal) and Section 2(d) (Right of First Refusal) of Attachment P (Sale of Facility by Seller); and
- (f) Seller's obligations under Section 3 (Seller Payment to Company for Company-Owned Interconnection

Facilities and Review of Facility) of Attachment G (Company-Owned Interconnection Facilities) to pay interconnection costs and Section 4 (Ongoing Operation and Maintenance Charges) of Attachment G (Company-Owned Interconnection Facilities) to pay operation and maintenance costs incurred up to the date of termination of the Agreement.

29.26 Certain Rules of Construction. For purposes of this Agreement:

- (a) "Including" and any other words or phrases of inclusion will not be construed as terms of limitation, so that references to "included" matters will be regarded as non-exclusive, non-characterizing illustrations.
- (b) "Copy" or "copies" means that the copy or copies of the material to which it relates are true, correct and complete.
- (c) When "Article," "Section," "Schedule," or "Attachment" is capitalized in this Agreement, it refers to an article, section, schedule or attachment to this Agreement.
- (d) "Will" has the same meaning as "shall" and, thus, connotes an obligation and an imperative and not a futurity.
- (e) Titles and captions of or in this Agreement, the cover sheet and table of contents of this Agreement, and language in parenthesis following Section references are inserted only as a matter of convenience and in no way define, limit, extend or describe the scope of this Agreement or the intent of any of its provisions.
- (f) Whenever the context requires, the singular includes the plural and plural includes the singular, and the gender of any pronoun includes the other genders.
- (g) Any reference to any statutory provision includes each successor provision and all applicable Laws as to that provision.

**[Signatures for PPA for Renewable Dispatchable Generation
appear on the following page]**

IN WITNESS WHEREOF, Company and Seller have executed this Agreement as of the day and year first above written.

By _____
Name:
Its:

By _____
Name:
Its:

("Company")

By _____
Name:
Its:

By _____
Name:
Its:

("Seller")

SCHEDULE OF DEFINED TERMS

For the purposes of this Agreement, the following capitalized terms shall have the meanings set forth below:

"Acceptance Test": A test conducted by Seller and witnessed by Company, within thirty (30) Days of completion of all Interconnection Facilities and in accordance with criteria and test procedures determined by Company and Seller as set forth in Section 2(f) (Acceptance Test Procedure) of Attachment G (Company-Owned Interconnection Facilities), to determine conformance with Article 3 (Facility Owned and/or Operated by Seller) and Attachment G (Company-Owned Interconnection Facilities) and Good Engineering and Operating Practices. Attachment N (Acceptance Test General Criteria) provides general criteria to be included in the written protocol for the Acceptance Test. Successful completion of the Acceptance Test shall be a condition precedent for the performance of the Control System Acceptance Test and the Commercial Operations Date.

"Active Power Control Interface": Shall have the meaning set forth in Section 1(g) (Active Power Control Interface) of Attachment B (Facility Owned by Seller) of this Agreement.

"Actual Output": The total quantity of electric energy (measured in kilowatt hours) produced by the Facility over a given time period and delivered to the Point of Interconnection, as measured by the revenue meter. "Actual Output" is the equivalent of "Net Energy."

"AF Disagreement": Shall have the meaning set forth in Section 2(a) (Notice of Disagreement With Monthly Report) of Attachment T (Monthly Reporting and Dispute Resolution by Independent AF Evaluator) to this Agreement.

"AF LD Assessment Date": For the last month of each LD Period, the Day following the expiration of the 10-Business Day period provided for Company to submit a written notice of MPR Disagreement pursuant to Section 2(a) (Notice of Disagreement With Monthly Report) of Attachment T (Monthly Reporting and Dispute Resolution by Independent AF Evaluator) to this Agreement.

"Agreement": Shall have the meaning set forth in the preamble to this Agreement.

"Allowed Capacity": Shall have the meaning set forth in Section 5(e) of Attachment A (Description of Generation and Conversion

Facility) to this Agreement.

"Appeal Period": Shall have the meaning set forth in Section 29.20(b) (Non-appealable PUC Approval Order) of this Agreement.

"Applicable Period Lump Sum Payment": For each applicable period, the total amount of Lump Sum Payment payable during such period, as such amount may be calculated and adjusted from time to time as set forth in Section 3 (Calculation of Lump Sum Payment) of Attachment J (Company Payments for Energy and Dispatchability) to this Agreement, including but not limited to any downward adjustment made pursuant to Section 3.iv of said Attachment J, but excluding any off-set of liquidated damages under Section 2.5(c) (Payment of Liquidated Damages for Failure to Achieve the Availability Benchmark) and Section 2.6(d) (Payment of Liquidated Damages for Failure to Achieve the GPR Benchmark) of this Agreement. For purposes of calculating liquidated damages under Section 2.5(b) (Availability Benchmark and Liquidated Damages), the "Applicable Period Lump Sum Payment" is the monthly Lump Sum Payment payable for the last calendar month of the LD Period in question. For purposes of calculating liquidated damages under Section 2.6(c) (GPR Benchmark and Liquidated Damages), the "Applicable Period Lump Sum Payment" is the monthly Lump Sum Payment payable for the last calendar month of the LD Period in question.

"Applicable NEP Verification Date": For the Initial OEPR, the Initial NEP Verification Date. For any Subsequent OEPR, the first day of the calendar month following the calendar month during which there occurs the first anniversary of the event (e.g., completion of equipment replacement) which occasioned the preparation of such Subsequent OEPR.

"Availability Benchmark": An Availability Factor of not less than 99%.

"Availability Factor": For each LD Period, the availability factor for the Facility calculated as provided in Section 2.5(a) (Calculation of Availability Factor) of this Agreement.

"Bill of Material": A list of equipment to be installed at the Facility including, but not necessarily limited to, items such as relays, breakers, and switches.

"Business Day": Any calendar day that is not a Saturday, a Sunday, or a federal or Hawai'i state holiday.

"Claim": Any claim, suit, action, demand or proceeding.

"Claiming Entity": Shall mean Seller and any direct or indirect owner of a membership interest in Seller which is eligible to claim a Refundable Tax Credit or Non-Refundable Tax Credit in a given year.

"COD Delay LD Period": Shall have the meaning set forth in Section 13.4(a)(2).

"Commercial Operations": Upon satisfaction of the following conditions, the Facility shall be considered to have achieved Commercial Operations on the Day specified in Seller's written notice described below: (i) the Acceptance Test has been passed, (ii) all generating units have passed Control System Acceptance Tests, (iii) the Transfer Date has occurred, (iv) Seller has (1) provided to Company the Required Models (as defined in Section 6(a) (Seller's Obligation to Provide Models) of Attachment B (Facility Owned by Seller)) in the form of Source Code, (2) placed the current version of the Source Code for the Required Models with the Source Code Escrow Agent as required in Section 6(b)(i)(A) (Establishment of Source Code Escrow) of Attachment B (Facility Owned by Seller), or (3) if Seller is unable to arrange for the placement of the appropriate Source Code into the Source Code Escrow account, placed the required funds with the Monetary Escrow Agent as required in Section 6(b)(ii)(A) (Establishment of Monetary Escrow) of Attachment B (Facility Owned by Seller), and (v) Seller provides Company with written notice that (aa) Seller is ready to declare the Commercial Operations Date and (bb) the Commercial Operations Date will occur within 24 hours (i.e., the next Day).

"Commercial Operations Date" (or "COD"): The date on which Facility first achieves Commercial Operations.

"Company": Shall have the meaning set forth in the preamble to this Agreement.

"Company-Designated NEP Estimate": The estimated Net Energy Potential of the Facility as designated by Company pursuant to Section 1(c) (NEP IE Estimate and Company-Designated NEP Estimate) of Attachment U (Calculation and Adjustment of Net energy Potential) this Agreement.

"Company Dispatch": Company's right, through supervisory equipment or otherwise, to direct or control both the capacity and the energy output of the Facility from its minimum output rating to

its maximum output rating consistent with this Agreement (including, without limitation, Good Engineering and Operating Practices and the requirements set forth in Attachment B (Facility Owned by Seller), Section 3 (Performance Standards) of this Agreement), which dispatch shall include real power, reactive power, voltage, frequency, the determination to cycle a unit off-line or to restart a unit, the droop control setting, the ramp rate setting, and other characteristics of such electric energy output whose parameters are normally controlled or accounted for in a utility dispatching system.

"Company-Owned Interconnection Facilities": Shall have the meaning set forth in Section 1(a) (Description of Company-Owned Interconnection Facilities) of Attachment G (Company-Owned Interconnection Facilities).

"Company System": The electric system owned and operated by Company (to include any non-utility owned facilities) consisting of power plants, transmission and distribution lines, and related equipment for the production and delivery of electric power to the public.

"Company System Operator": The authorized representative of Company who is responsible for carrying out Company dispatch and curtailment of electric energy generation interconnected to the Company System.

"Competitive Bidding Framework": The Framework for Competitive Bidding contained in Decision and Order No. 23121 issued by the Public Utilities Commission on December 8, 2006, and any subsequent orders providing for modifications from those set forth in Order No. 23121 issued December 8, 2006.

"Construction Delay LD Period": Shall have the meaning set forth in Section 13.4(a)(1).

"Construction Financing Closing Milestone": Shall have the meaning set forth in Attachment K (Guaranteed Project Milestones) and Attachment L (Reporting Milestones).

"Construction Milestones": The Reporting Milestones set forth in Attachment L (Reporting Milestones) and the Guaranteed Project Milestones set forth in Attachment K (Guaranteed Project Milestones).

"Construction Start Date Milestone": The date by which continuous construction of permanent structures shall begin at the Site in

accordance with Attachment L (Reporting Milestones). **[FOR WIND FACILITIES ADD: The Construction Start Date occurs when Seller begins pouring the foundation for the first Wind Turbine. FOR PV FACILITIES ADD: The Construction Start Date occurs when Seller begins installation of the mounting and racking components.]**

"Consumer Advocate": Shall have the meaning set forth in Section 24.2 (Confidentiality).

"Contract Capacity": Shall have the meaning set forth in Section 5(b) (Design and Capacity) of (Attachment A (Description of Generation and Conversion Facility) to this Agreement.

"Contract Pricing": The total of the Energy Payment and the Lump Sum Payment.

"Contract Year": A twelve (12) calendar month period commencing on either: (i) the Commercial Operations Date (if the Commercial Operations Date occurs on the first Day of a calendar month) and thereafter on each anniversary of the Commercial Operations Date; or (ii) the first Day of the calendar month following the month during which the Commercial Operations Date occurs, and thereafter on each anniversary of the first Day of such month; provided, however, that, in the latter case, the initial Contract Year shall also include the Days from the Commercial Operations Date to the first Day of the succeeding calendar month.

"Control System Acceptance Test(s)": A test or tests performed on the centralized and collective control systems and Active Power Control Interface of the Facility, which includes successful completion of the Control System RTU Points List, in accordance with procedures set forth in Section 1(h) (Control System Acceptance Test Procedures) of Attachment B (Facility Owned by Seller). Attachment O (Control System Acceptance Test Criteria) provides general criteria to be included in the written protocol for the Control System Acceptance Test.

"Control System RTU Points List" - The Control System RTU Points List includes, but is not limited to, all of the Facility's equipment and generation performance/quality parameters that will be monitored, alarmed and/or controlled by Company's Energy Management System (EMS) throughout the Term of this Agreement.

Examples of the Control System RTU Points List include:

- Seller's substation/equipment status - breaker open/closed status, equipment normal/alarm operating status, etc.
- Seller's generation data (analog values) - number of generators available/online, voltage, current, MW, MVAR, etc.
- Seller's generation performance (status and/or analog values) - ramp rate, generator frequency, etc.
- Curtailment control interface - curtailment MW setpoint, etc.
- Voltage control interface - voltage kV setpoint, etc.
- Power factor control interface - power factor setpoint, etc.

This Control System RTU Points List is necessary for the effective operation of the Company System and will be tested during the Control System Acceptance Test.

"Daily Delay Damages": Shall have the meaning set forth in Section 13.4(a) (Daily Delay Damages) of this Agreement.

"Day": A calendar day.

"Defaulting Party": The Party whose failure, action or breach of its obligations under this Agreement results in an Event of Default under Article 15 (Events of Default) of this Agreement.

"Development Period Security": An amount equal to \$50/kW of the Contract Capacity.

"Dispute": Shall have the meaning set forth in Section 28.1 (Good Faith Negotiations).

"DownTime": Shall have the meaning set forth in Section 2.5(a) (Calculation of the Availability Factor) of this Agreement.

"DPR": Shall have the meaning set forth in Section 28.2 (Dispute Resolution Procedures, Mediation).

"Effective Date": Shall mean the last to occur of (i) the Non-appealable PUC Approval Order Date and (ii) the date that the Interconnection Requirements Amendment (if required pursuant to Section 12.4(a) of this Agreement) is executed and delivered as such date is set forth in the Interconnection Requirements Amendment.

"Eligible Period": Shall have the meaning set forth in Section 1(b)(ii)(H)(i) of Attachment B (Facility Owned by Seller) to this Agreement.

"EMS" or "Energy Management System": The real-time, computer-based control system, or any successor thereto, used by Company to manage the supply and delivery of electric energy to its consumers. It provides the Company System Operator with an integrated set of manual and automatic functions necessary for the operation of the Company System under both normal and emergency conditions. The EMS provides the interfaces for the Company System Operator to perform real-time monitoring and control of the Company System, including but not limited to monitoring and control of the Facility for system balancing, supplemental frequency control and economic dispatch as prescribed in this Agreement.

"Energy Cost Adjustment Clause": The provision in Company's rate schedules that allows Company to pass through to its customers Company's costs of fuel and purchased power.

"Energy Payment": The amount that Company will pay Seller for electric energy delivered to Company in accordance with the terms and conditions of this Agreement on a monthly basis as set forth in Attachment J (Company Payments for Energy and Dispatchability) to this Agreement.

"Engineering and Design Work": Shall have the meaning set forth in Section 3(a) of Attachment G (Company-Owned Interconnection Facilities).

"Environmental Credits": Any environmental credit, offset, or other benefit allocated, assigned or otherwise awarded by any Governmental Authority, international agency, or non-governmental renewable energy certificate accounting and verification organization to Company or Seller based in whole or in part on the fact that the Facility is a non-fossil fuel facility. Such Environmental Credits shall include, without limitation, the non-energy attributes of renewable energy including, but not limited to, any avoided emissions of pollutants to the air, soil, or water such as sulfur dioxide, nitrogen oxides, carbon monoxide, particulate matter, and hazardous air pollutants; any other pollutant that is now or may in the future be regulated under the pollution control laws of the United States; and avoided emissions of carbon dioxide and any other greenhouse gas, along with the renewable energy certificate reporting rights to these avoided emissions, but in all cases shall not mean tax credits.

"Escrow Agent": Shall have the meaning set forth in Section 14.9 (L/C Proceeds Escrow).

"Evaluation Period": Shall have the meaning set forth in Section 1(b)(iii)(H)(i) of Attachment B (Facility Owned by Seller) to this Agreement.

"Event of Default": Shall have the meaning set forth in Article 15 (Events of Default) of this Agreement.

"Excess Energy Conditions": An operating condition on the Company System that may occur when Company has more energy available than is required to meet the load on the Company System at any point in time and the generating assets interconnected with the Company System are operating at or near their minimum levels, taking into consideration factors such as the need to maintain system reliability and stability under changing system conditions and configurations, the need for downward regulating reserves, the terms and conditions of power purchase agreements for base-loaded firm capacity or scheduled energy, and the normal minimum loading levels of such units.

"ExcludedTime": Shall have the meaning set forth in Section 2.5(a) (Calculation of the Availability Factor) of this Agreement.

"Execution Date": The date designated as such on the first page of this Agreement or, if no date is so designated, the date the Parties exchanged executed signature pages to this Agreement.

"Extended Term": Shall have the meaning set forth in Section 12.1 (Term) of this Agreement.

"Facility": Seller's renewable electric energy facility that is the subject of this Agreement, including all Seller-Owned Interconnection Facilities and all other equipment, devices, associated appurtenances owned, controlled, operated and managed by Seller in connection with, or to facilitate, the production, generation, transmission, delivery or furnishing of electric energy by Seller to Company and required to interconnect with the Company System.

"Facility Debt": The obligations of Seller to any lender pursuant to the Financing Documents, including without limitation, principal of, premium and interest on indebtedness, fees, expenses or penalties, amounts due upon acceleration, prepayment or

restructuring, swap or interest rate hedging breakage costs and any claims or interest due with respect to any of the foregoing.

"Facility Lender": Any lender(s) providing any Facility Debt and any successor(s) or assigns thereto, collectively.

"FASB": Shall have the meaning set forth in Section 24.1 (Financial Compliance).

"FASB ASC 810": Shall have the meaning set forth in Section 24.1 (Financial Compliance).

"FASB ASC 842": Shall have the meaning set forth in Section 24.5 (Consolidation and Lease).

"Financial Compliance Information": Shall have the meaning set forth in Section 24.1 (Financial Compliance).

"Financial Termination Costs": Shall have the meaning set forth in Section 6 (Make Whole Amount) of Attachment P (Sale of Facility by Seller).

"Financing Documents": The loan and credit agreements, notes, bonds, indentures, security agreements, lease financing agreements, mortgages, deeds of trust, interest rate exchanges, swap agreements and other documents relating to the development, bridge, construction and/or permanent debt financing for the Facility, including any credit enhancement, credit support, working capital financing, tax equity financing or refinancing documents, and any and all amendments, modifications, or supplements to the foregoing that may be entered into from time to time at the discretion of Seller in connection with development, construction, ownership, leasing, operation or maintenance of the Facility.

"First Benchmark Period": The period commencing on the Commercial Operations Date and ending on the last Day of the calendar month during which an OEPR Evaluator issues the Initial OEPR. During the First Benchmark Period, the First NEP Benchmark shall be the estimate of Net Energy Potential that is used to calculate the Lump Sum Payment as provided in Section 3.i (Lump Sum Payment During First Benchmark Period) of Attachment J (Company Payments for Energy and Dispatchability) to this Agreement.

"First NEP Benchmark": The estimate of Net Energy Potential that is used to calculate the Lump Sum Payment during the First Benchmark Period as provided in Section 3.i (Lump Sum Payment

During First Benchmark Period) of Attachment J (Company Payments for Energy and Dispatchability) to this Agreement. The "First NEP Benchmark" shall consist of whichever of the following is applicable as of the Commercial Operation Date, as more fully provided in Section 1(c) (NEP IE Estimate and Company-Designated NEP Estimate) and Section 1(d) (NEP IE Estimate, Liquidated Damages and Seller's Null and Void Right) of Attachment U (Calculation and Adjustment of Net Energy Potential) to this Agreement: (i) NEP RFP Projection, (ii) NEP IE Estimate, (iii) Company-Designated NEP Estimate or (iv) such other amount as the Parties may agree in writing.

"Force Majeure": An event that satisfies the requirements of Section 21.1 (Definition of Force Majeure), Section 21.2 (Events That Could Qualify as Force Majeure) and Section 21.3 (Exclusions From Force Majeure).

"Forced Outage": An unplanned unit shutdown caused by factors such as automatic or programmed protective trips and trips due to equipment malfunction, and which terminates when Company determines according to Good Engineering and Operating Practices that it is safe to bring the Facility back onto the Company System.

"Full Dispatch": A time period during which all inverters are available and the Facility's set point is not less than the Allowed Capacity.

"Good Engineering and Operating Practices": The practices, methods and acts engaged in or approved by a significant portion of the electric utility industry for similarly situated U.S. facilities, considering Company's isolated island setting, that at a particular time, in the exercise of reasonable judgment in light of the facts known or that reasonably should be known at the time a decision is made, would be expected to accomplish the desired result in a manner consistent with law, regulation, reliability for an island system, safety, environmental protection, economy and expedition. With respect to the Facility, Good Engineering and Operating Practices include, but are not limited to, taking reasonable steps to ensure that:

- (a) Adequate materials, resources and supplies, including fuel, are available to meet the Facility's needs under normal conditions and reasonably foreseeable abnormal conditions.

- (b) Sufficient operating personnel are available and are adequately experienced and trained to operate the Facility properly, efficiently and within manufacturer's guidelines and specifications and are capable of responding to emergency conditions.
- (c) Preventive, routine and non-routine maintenance and repairs are performed on a basis that ensures reliable long-term and safe operation, and are performed by knowledgeable, trained and experienced personnel utilizing proper equipment, tools, and procedures.
- (d) Appropriate monitoring and testing is done to ensure equipment is functioning as designed and to provide assurance that equipment will function properly under both normal and reasonably foreseeable abnormal conditions.
- (e) Equipment is operated in a manner safe to workers, the general public and the environment and in accordance with equipment manufacturer's specifications, including, without limitation, defined limitations such as steam pressure, temperature, moisture content, chemical content, quality of make-up water, operating voltage, current, frequency, rotational speed, polarity, synchronization, control system limits, etc.

"Governmental Approvals": All permits, licenses, approvals, certificates, entitlements and other authorizations issued by Governmental Authorities, as well as any agreements with Governmental Authorities, required for the construction, ownership, operation and maintenance of the Facility and the Company-Owned Interconnection Facilities, and all amendments, modifications, supplements, general conditions and addenda thereto.

"Governmental Authority": Any federal, state, local or municipal governmental body; any governmental, quasi-governmental, regulatory or administrative agency, commission, body or other authority exercising or entitled to exercise any administrative, executive, judicial, legislative, policy, regulatory or taxing authority or power; or any court or governmental tribunal.

"GPR Benchmark": The minimum Measured Performance Ratio that the Facility is required to achieve in order to avoid assessment of liquidated damages under Section 2.6(c) (GPR Benchmark and Liquidated Damages) of this Agreement. The GPR Benchmark shall be

determined and, from time to time, redetermined as provided in Section 2.6(b) (Determination of GPR Benchmark) of this Agreement.

"GPR Benchmark Disagreement": Shall have the meaning set forth in Section 2(b) (Notice of Disagreement With GPR Benchmark Determination) of Attachment T (Monthly Reporting and Dispute Resolution by Independent AF Evaluator) to this Agreement.

"Guaranteed Commercial Operations Date": The date specified as such in Attachment K (Guaranteed Project Milestones) of this Agreement, by which Seller guarantees that it will achieve the Commercial Operations Date.

"Guaranteed 180-Day Milestone Date": The date that is 180 Days following the Effective Date, as specified in Attachment K (Guaranteed Project Milestones).

"Guaranteed Procurement Payment Date": The earlier of (i) date that is 30 Days following the Effective Date or (ii) **[INSERT CALENDAR DATE BY WHICH EQUIPMENT MUST BE ORDERED TO MEET CONSTRUCTION SCHEDULE]**.

"Guaranteed Project Milestone": Each of (i) the Procurement Payment Milestone, (ii) the 180-Day Milestone, (iii) Commercial Operations and (iv) any other of the milestone events identified as a "Guaranteed Project Milestone" in Attachment K (Guaranteed Project Milestones) of this Agreement.

"Guaranteed Project Milestone Date": Each of (i) the Guaranteed Procurement Payment Date, (ii) the Guaranteed 180-Day Milestone Date, (iii) the Guaranteed Commercial Operations Date, and (iv) any other milestone dates identified as a "Guaranteed Project Milestone Date" in Attachment K (Guaranteed Project Milestones) of this Agreement.

"Hawai'i Investment Tax Credit": Shall mean a credit against Hawai'i source income for which Seller is eligible on the Commercial Operations Date or thereafter because of investment in renewable energy technologies incorporated into the Facility.

"Hawai'i Production Tax Credit": Shall mean a credit against Hawai'i source income for which Seller is eligible on the Commercial Operations Date or thereafter because of the energy produced by the Facility.

"HEI": Hawaiian Electric Industries, Inc.

"HERA": The Hawai'i Electricity Reliability Administrator.

"HERA Law": Act 166 (Haw. Leg. 2012), which was passed by the 27th Hawai'i Legislature in the form of S.B. No. 2787, S.D. 2, H.D.2, C.D.1 on May 2, 2012 and signed by the Governor on June 27, 2012. The effective date for the law is July 1, 2012. The HERA Law authorizes (i) the PUC to develop, adopt, and enforce reliability standards and interconnection requirements, (ii) the PUC to contract for the performance of related duties with a party that will serve as the HERA, and (iii) the collection of a Hawai'i electricity reliability surcharge to be collected by Hawai'i's electric utilities and used by the HERA. Reliability standards and interconnection requirements adopted by the PUC pursuant to the HERA Law will apply to any electric utility and any user, owner, or operator of the Hawai'i electric system. The PUC also is provided with the authority to monitor and compel the production of data, files, maps, reports, or any other information concerning any electric utility, any user, owner or operator of the Hawai'i electric system, or other person, business, or entity, considered by the commission to be necessary for exercising jurisdiction over interconnection to the Hawai'i electric system, or for administering the process for interconnection to the Hawai'i electric system.

"IE Energy Assessment Report": The bankable energy assessment report (including but not limited to an assessment of the Facility's Net Energy Potential) prepared for the Facility Lender by an independent engineer as part of the Facility Lender's due diligence leading up to the Facility Lender's legally binding commitment to provide a specific amount of financing for the Project as evidenced by the Facility Lender's execution of the Financing Documents.

"Indemnified Company Party": Shall have the meaning set forth in Section 17.1(a) (Indemnification Against Third Party Claims) of this Agreement.

"Indemnified Seller Party": Shall have the meaning set forth in Section 17.2(a) (Indemnification Against Third Party Claims) of this Agreement.

"Independent Evaluator": A person empowered, pursuant to Section 23.5 (Failure to Reach Agreement) and Section 23.10 (Dispute) of this Agreement, to resolve disputes due to failure of the Parties to agree on a Performance Standards Revision Document.

"Independent AF Evaluator": A person empowered, pursuant to Section 2(e) (Appointment of Independent AF Evaluator) of Attachment T (Monthly Reporting and Dispute Resolution by Independent AF Evaluator) to resolve disagreements due to failure of the Parties to resolve a Monthly Report Disagreement or a GPR Benchmark Disagreement.

"Initial NEP OEPR Estimate": The NEP OEPR Estimate set forth in or derived from the Initial OEPR, as more fully set forth in Section 4(e) (Terms of Engagement) of Attachment U (Calculation and Adjustment of Net Energy Potential) to this Agreement.

"Initial NEP Verification Date": The first Day of the calendar month following the calendar month during which there occurs the first anniversary of the Commercial Operations Date.

"Initial OEPR": The OEPR to be prepared pursuant in Section 2 (Initial OEPR) of Attachment U (Calculation and Adjustment of Net Energy Potential) to this Agreement.

"Initial Term": Shall have the meaning set forth in Section 12.1 (Term).

"Interconnection Facilities": The equipment and devices required to permit the Facility to operate in parallel with, and deliver electric energy to, the Company System and provide reliable and safe operation of, and power quality on, the Company System (in accordance with applicable provisions of the PUC's General Order No. 7, Company tariffs, operational practices, interconnection requirements studies, and planning criteria), such as, but not limited to, transmission and distribution lines, transformers, switches, and circuit breakers.

"Interconnection Requirements Amendment": Shall have the meaning set forth in Section 12.4(a) of this Agreement.

"Interconnection Requirements Study" or "IRS": A study, performed in accordance with the terms of the IRS Letter Agreement to determine, among other things, (a) the system requirements and equipment requirements to interconnect the Facility with the Company System, (b) the Performance Standards for the Facility, and (c) an estimate of interconnection costs and project schedule for interconnection of the Facility.

"Interconnection Requirements Study Letter Agreement" or "IRS Letter Agreement": The letter agreement and any written, signed amendments thereto, between Company and Seller that describes the

scope, schedule, and payment arrangements for the Interconnection Requirements Study.

"Interface Block Diagram": The visual representation of the signals between Seller and Company, including but not limited to, RTU points, digital fault recorder settings, telecommunications and protection signals.

"kV": Kilovolt.

"kW": Kilowatt. Unless expressly provided otherwise, all kW values stated in this Agreement are alternating current values and not direct current values.

"Land Rights": All easements, rights of way, licenses, leases, surface use agreements and other interests or rights in real estate.

"Laws": All federal, state and local laws, rules, regulations, orders, ordinances, permit conditions and other governmental actions.

"L/C Proceeds": Shall have the meaning set forth in Section 14.8 (Failure to Renew or Extend Letter of Credit).

"LD Period": A rolling period of twelve (12) calendar months each. At the end of each calendar month, the LD Period rolls forward to include the next calendar month. The initial "LD Period" shall consist of the 12 full calendar months of the initial Contract Year.

"Losses": Any and all direct, indirect or consequential damages, fines, penalties, deficiencies, losses, liabilities (including settlements and judgments), costs, expenses (including reasonable attorneys' fees and court costs) and disbursements.

"Lump Sum Payment": The payment to be made by Company to Seller in exchange for Seller making the Net Energy Potential of the Facility available for dispatch by Company. When necessary to account for the availability of some but not all inverters, the amount of the monthly Lump Sum Payment is to be allocated pro rata to each inverter and shall be calculated and adjusted as provided in Section 3 (Calculation of Lump Sum Payment) of Attachment J (Company Payments for Energy and Dispatchability) to this Agreement.

"Make Whole Amount": Shall have the meaning set forth in Section 6 (Make Whole Amount) of Attachment P (Sale of Facility by Seller).

"Malware": means computer software, code or instructions that: (a) intentionally, and with malice intent by a third party, adversely affect the operation, security or integrity of a computing, telecommunications or other digital operating or processing system or environment, including without limitation, other programs, data, databases, computer libraries and computer and communications equipment, by altering, destroying, disrupting or inhibiting such operation, security or integrity; (b) without functional purpose, self-replicate without manual intervention; (c) purport to perform a useful function but which actually performs either a destructive or harmful function, or perform no useful function other than utilize substantial computer, telecommunications or memory resources with the intent of causing harm; or (d) without authorization collect and/or transmit to third parties any information or data; including such software, code or instructions commonly known as viruses, Trojans, logic bombs, worms, adware and spyware.

"Management Meeting": Shall have the meaning set forth in Section 28.1 (Good Faith Negotiations).

"Measured Performance Ratio": Shall have the meaning set forth in Section 2.6(a) (Calculation of Measured Performance Ratio ("MPR")) of this Agreement.

"Measured Wind Speed": The arithmetic mean, over any given period of time, of the wind speed readings from each of the Facility's MMS anemometers, taken or sampled every two (2) seconds by the Facility's monitoring equipment, in miles per hour (mph).

"MMS": Meteorological monitoring station.

"Monetary Authorized Use": Shall have the meaning set forth in Section 6(b)(ii)(h) (Authorized Use) of Attachment B (Facility Owned by Seller) of this Agreement.

"Monetary Escrow Agent": Shall mean [] or such other escrow agent approved by Company.

"Monetary Escrow Agreement": Shall mean a three party escrow agreement between Seller, Company and the Monetary Escrow Agent naming Company as beneficiary thereunder, which agreement shall be acceptable in form and substance to Company.

"Monitoring and Communication Equipment": Shall have the meaning set forth in Section 6.2 (Monitoring and Communication Equipment) of this Agreement.

"Monthly Progress Report": Shall have the meaning set forth in Section 13.7 (Monthly Progress Report).

"Monthly Report": The report of the data (both for the calendar month and the LD Period ending with such calendar month) necessary for the calculation of the Availability Factor and the Measured Performance Ratio to be provided by Seller to Company as set forth in Section 1 (Monthly Report) of Attachment T (Monthly Reporting and Dispute Resolution by Independent AF Evaluator) to this Agreement.

"Monthly Report Disagreement:" Any disagreement (e.g., an AF Disagreement and/or a MPR Disagreement) arising out of the same Monthly Report.

"Most Recent Prior NEP Benchmark": In the event a Subsequent OEPR is prepared for an OEPR Period of Record ending on or after the commencement of the fourth (4th) Contract Year, the "Most Recent Prior NEP Benchmark" shall be (i) for the first such Subsequent OEPR, the Second NEP Benchmark that was used to calculate the Lump Sum Payment for the last month of the Second Benchmark Period pursuant to Section 3.iii.a of Attachment J (Company Payments for Energy Dispatchability) to this Agreement and (ii) for all Subsequent OEPRs prepared after the aforementioned first Subsequent OEPR, the NEP OEPR Estimate obtained from the immediately preceding Subsequent OEPR.

"MPR Disagreement": Shall have the meaning set forth in Section 2(a) (Notice of Disagreement With Monthly Report) of Attachment T (Monthly Reporting and Dispute Resolution by Independent AF Evaluator) to this Agreement.

"MPR LD Assessment Date": For the last month of each LD Period, the Day following the expiration of the 10-Business Day period provided for Company to submit a written notice of MPR Disagreement pursuant to Section 2(a) (Notice of Disagreement With Monthly Report) of Attachment T (Monthly Reporting and Dispute Resolution by Independent AF Evaluator) to this Agreement.

"MW": Megawatt. Unless expressly provided otherwise, all MW values stated in this Agreement are alternating current values and not direct current values.

"NEP IE Estimate": The estimated Net Energy Potential of the Facility to which the IE Energy Assessment Report assigns a P-Value of 95 for a ten-year period.

"NEP OEPR Estimate": For each OEPR, the estimated Net Energy Potential of the Facility to which such OEPR assigns a P-Value of 95 for a ten-year period.

"NEP RFP Projection": The Net Energy Potential of the Facility to which the Seller in Seller's [Response to RFP] assigns a P-Value of 95 for a ten-year period.

"Net Energy": The total quantity of electric energy (measured in kilowatt hours) produced by the Facility over a given time period and delivered to the Point of Interconnection, as measured by the revenue meter. "Net Energy" the equivalent of "Actual Output."

"Net Energy Potential": The estimated single number with a P-Value of 95 for the annual Net Energy that could be produced by the Facility based on the estimated long-term monthly and annual total of such production over a ten-year period. The Net Energy Potential is subject to adjustment as provided in Attachment U (Calculation and Adjustment of Net Energy Potential) to this Agreement, but in no circumstances shall the Net Energy Potential exceed the NEP RFP Projection.

"Non-appealable PUC Approval Order": Shall have the meaning set forth in Section 29.20(b) (Non-appealable PUC Approval Order) of this Agreement.

"Non-appealable PUC Approval Order Date": Shall have the meaning set forth in Section 29.20(d) (Non-appealable PUC Approval Order Date) of this Agreement.

"Non-defaulting Party": Shall have the meaning set forth in Section 15.4 (Rights of Non-Defaulting Party; Forward Contract) of this Agreement.

"Non-performing Party": The Party who is in breach of, or is otherwise failing to perform, its obligations under this Agreement.

"Non-Refundable Tax Credit": Shall mean any U.S. federal tax credit and State of Hawai'i tax credit (including both a Hawai'i Investment Tax Credit and a Hawai'i Production Tax Credit) for which the federal government or State of Hawai'i is not required to refund any tax credit which exceeds the tax payments due to the

federal government or State of Hawai'i by the Claiming Entity or to provide a cash rebate in lieu of such credit to the Claiming Entity.

"Notice of AF Disagreement": The written notice of an AF Disagreement submitted by Company within the 10-Day period set forth in Section 2(a) (Notice of Disagreement With Monthly Report) of Attachment T (Monthly Reporting and Dispute Resolution by Independent AF Evaluator).

"Notice of Disagreement": Any of a Notice of AF Disagreement, a Notice of GPR Benchmark Disagreement and a Notice of MPR Disagreement.

"Notice of GPR Benchmark Disagreement": The written notice of GPR Benchmark Disagreement submitted by Seller within the 30-Day period set forth in Section 2(b) (Notice of Disagreement With GPR Benchmark Determination) of Attachment T (Monthly Reporting and Dispute Resolution by Independent AF Evaluator) to this Agreement.

"Notice of MPR Disagreement": The written notice of MPR Disagreement submitted by Company within the 10-Business Day period set forth in Section 2(a) (Notice of Disagreement With Monthly Report) of Attachment T (Monthly Reporting and Dispute Resolution by Independent AF Evaluator) to this Agreement.

"180-Day Milestone": All of the events identified as constituting the "180-Day Milestone" in Attachment K (Guaranteed Project Milestones).

"OEPR": An Operational Energy Production Report, including the Initial OEPR and each Subsequent OEPR.

"OEPR Consultants List": The engineering firms listed in Section 4(h) (Acceptable Persons and Entities) of Attachment U (Calculation and Adjustment of Net Energy Potential) to this Agreement, as such list may be expanded or contracted by the Parties as provided in Section 4(b) (Eligibility for Appointment as OEPR Evaluator) of said Attachment U or Section 2(f) (Eligibility for Appointment as Independent AF Evaluator) of Attachment T (Monthly Reporting and Dispute Resolution by Independent AF Evaluator) to this Agreement.

"OEPR Evaluator": Shall have the meaning set forth in Section 4(a) (Selection of OEPR Evaluator) of Attachment U (Calculation and Adjustment of Net Energy Potential) of this Agreement.

"OEPR Period of Record": For each OEPR, the twelve-month period preceding the Applicable NEP Verification Date for such OEPR.

"Operating Period Security": Shall have the meaning set forth in Section 14.4 (Operating Period Security).

"Ownership Control": Shall have the meaning set forth in Section 1(b)(ii) of Attachment P (Sale of Facility by Seller) to this Agreement.

"Ownership Interest": Shall have the meaning set forth in Section 1(b)(i) of Attachment P (Sale of Facility by Seller) to this Agreement.

"P-Value": The probability of exceedance.

"Parties": Seller and Company, collectively.

"Party": Each of Seller or Company.

"Performance Standards": The various performance standards for the operation of the Facility and the delivery of electric energy from the Facility to Company specified in Section 3 (Performance Standards) of Attachment B (Facility Owned by Seller), as such standards may be revised from time to time pursuant to Article 23 (Process for Addressing Revisions to Performance Standards) of this Agreement.

"Performance Standards Information Request": A written notice from Company to Seller proposing revisions to one or more of the Performance Standards then in effect and requesting information from Seller concerning such proposed revision(s).

"Performance Standards Modifications": For each Performance Standards Revision, any capital improvements, additions, enhancements, replacements, repairs or other operational modifications to the Facility and/or to changes in Seller's operations or maintenance practices necessary to enable the Facility to achieve the performance requirements of such Performance Standards Revision.

"Performance Standards Pricing Impact": Any adjustment in Contract Pricing necessary to specifically reflect the recovery of the net costs and/or net lost revenues specifically attributable to any Performance Standards Modification necessary to comply with a Performance Standard Revision, which shall consist of the following: (i) recovery of, and return on, any capital investment

(aa) made over a cost recovery period starting after the Performance Standards Revision is made effective following a PUC Performance Standards Revision Order through the end of the Initial Term and (bb) based on a proposed capital structure that is commercially reasonable for such an investment and the return on investment is at market rates for such an investment or similar investment); (ii) recovery of reasonably expected net additional operating and maintenance costs; and (iii) an adjustment in pricing necessary to compensate Seller for reasonably expected reductions, if any, in the delivery of electric energy to Company under this Agreement, which shall consist of (yy) an increase in payments necessary to compensate Seller for expected reduced electric energy payments under this Agreement; and (zz) to the extent applicable, an increase in payments necessary to compensate Seller for reasonably expected reductions in receipt of production tax credits (pursuant to Section 45 of the Internal Revenue Code) calculated on an after-tax basis.

"Performance Standards Proposal": A written communication from Seller to Company detailing the following with respect to a proposed Performance Standards Revision: (i) a statement as to whether Seller believes that it is technically feasible to comply with the Performance Standards Revision and the basis therefor; (ii) the Performance Standards Modifications proposed by Seller to comply with the Performance Standards Revision; (iii) the capital and incremental operating costs of any necessary technical improvements, and any other incremental net operating or maintenance costs associated with any necessary operational changes, and any expected lost revenues associated with expected reductions in electric energy delivered to Company; (iv) the Performance Standards Pricing Impact of such costs and/or lost revenues; (v) information regarding the effectiveness of such technical improvements or operational modifications; (vi) proposed contractual consequences for failure to comply with the Performance Standard Revision that would be commercially reasonable under the circumstances; and (vii) such other information as may be reasonably required by Company to evaluate Seller's proposals. A Performance Standards Proposal may be issued either in response to a Performance Standards Information Request or on Seller's own initiative.

"Performance Standards Revision": A revision, as specified in a Performance Standards Information Request or a Seller-initiated Performance Standards Proposal, to the Performance Standards in effect as of the date of such Request or Proposal.

"Performance Standards Revision Document": A document specifying one or more Performance Standards Revisions and setting forth the changes to the Agreement necessary to implement such Performance Standards Revision(s). A Performance Standards Revision Document may be either a written agreement executed by Company and Seller or as directed by the Independent Evaluator pursuant to Section 23.10 (Dispute) of this Agreement, in the absence of such written agreement.

"Permit Application Filing Date Milestone": The date by which Seller shall file all applications for Government Approvals required for the ownership, construction, operation and maintenance of the Facility as set forth in Attachment K (Guaranteed Project Milestones).

"Point of Interconnection": The point of delivery of electric energy and/or capacity supplied by Seller to Company, where the Facility owned by the Seller interconnects with the Company System. The Seller shall own and maintain the facilities from the Facility to the Point of Interconnection, excluding any Company-Owned Interconnection Facilities located on the Site. The Company shall own and maintain the facilities from the Point of Interconnection to the Company's system. The Point of Interconnection will be identified in the IRS and set forth on the Single-Line Drawing and Interface Block Diagram in Attachment E (Single Line Drawing and Interface Block Diagram).

"Power Possible": The calculated power production of the Facility reported every two seconds in kilowatts ("kW") at the Point of Interconnection taking into account (i) equipment availability during the period (for example, self-curtailed units, derated units and units that are otherwise unavailable to produce electric energy), (ii) electric energy consumed by the Facility and electric losses from the solar panels to the Point of Interconnection and (iii) meteorological conditions. For purposes of performing the evaluations under Section 1(b)(iii)(H) of Attachment B (Facility Owned by Seller), Power Possible is the 15-minute average of the Power Possible values reported as aforesaid.

"Power Possible Discrepancy Period": Any Evaluation Period that satisfies the conditions of a Power Possible Discrepancy Period under Section 1(b)(iii)(H)(ii) of Attachment B (Facility Owned by Seller) to this Agreement.

"PPA Amendment Deadline": The 60th Day following the date the completed IRS is provided to Seller, or such later date as Company and Seller may agree to by written agreement.

"Prime Rate": The "prime rate" of interest, as published from time to time by The Wall Street Journal in the "Money Rates" section of its Western Edition Newspaper (or the average prime rate if a high and a low prime rate are therein reported). The Prime Rate shall change without notice with each change in the prime rate reported by The Wall Street Journal, as of the date such change is reported. Any such rate is a general reference rate of interest, may not be related to any other rate, may not be the lowest or best rate actually charged by any lender to any customer or a favored rate and may not correspond with future increases or decreases in interest rates charged by lenders or market rates in general.

"Procurement Payment Milestone": The payment in full by Seller to Company of the amount required under Section 3(b)(iii) (Balance of Company-owned Interconnection Facilities Prepayment) of Attachment G (Company-Owned Interconnection Facilities).

"Project": The Facility as described in Attachment A (Description of Generation and Conversion Facility).

"Project Documents": This Agreement, any ground lease or other agreement or instrument in respect of the Site and/or the Land Rights, all construction contracts to which Seller is or becomes a party thereto, operation and maintenance agreements, and all other agreements, documents and instruments to which Seller is or becomes a party thereto in respect of the Facility, other than the Financing Documents, as the same may be modified or amended from time to time in accordance with the terms thereof.

"Proprietary Rights": Shall have the meaning set forth in Section 29.17 (Proprietary Rights) of this Agreement.

"PUC": Shall have the meaning set forth in the Recitals.

"PUC Approval Order": Shall have the meaning set forth in Section 29.20(a) (PUC Approval Order) of this Agreement.

"PUC Approval Order Date": Shall have the meaning set forth in Section 29.20(c) (Company's Written Statement) of this Agreement.

"PUC Approval Time Period": Shall have the meaning set forth in Section 12.6(b) (Time Period for PUC Approval).

"PUC Performance Standards Revision Order": The decision and order of the PUC approving the application or motion by the Parties

seeking (i) approval of the Performance Standards Revision in question and the associated Performance Standards Revision Document, (ii) finding that the impact of the changes to the Contract Pricing on Company's revenue requirements is reasonable, and (iii) approval to include the costs arising out of pricing changes in Company's Energy Cost Adjustment Clause (or equivalent).

"PUC Submittal Date": The date of the submittal of Company's complete application or motion for a satisfactory PUC Approval Order pursuant to Section 12.3 (PUC Approval) of this Agreement.

"PUC's Standards": Standards for Small Power Production and Cogeneration in the State of Hawai'i, issued by the Public Utilities Commission of the State of Hawai'i, Chapter 74 of Title 6, Hawai'i Administrative Rules, currently in effect and as may be amended from time to time.

"PURPA": Public Utility Regulatory Policies Act of 1978 (P.L. 95-617) as amended from time to time and as applied in Hawai'i by the PUC.

"Qualifying Facility": As defined in the Public Utility Regulatory Policies Act of 1978 and the regulations issued thereunder.

"Recipient": Shall have the meaning set forth in Section 24.2 (Confidentiality).

"Refundable Tax Credit": Shall mean any U.S. federal tax credit or State of Hawai'i tax credit (including both a Hawai'i Investment Tax Credit and a Hawai'i Production Tax Credit) for which the federal government or State of Hawai'i is required to refund any tax credit which exceeds the tax payments due to the federal government or State of Hawai'i by the Claiming Entity or to provide a cash rebate in lieu of such credit to the Claiming Entity.

"Renewable Portfolio Standards" or "RPS": The Hawai'i law that mandates that Company and its subsidiaries generate or purchase certain amounts of their net electricity sales over time from qualified renewable resources. The RPS requirements in Hawai'i are currently codified as Hawai'i Revised Statutes (HRS) 269-91 through 269-95.

"Renewable Resource Baseline": The estimated renewable resource potential of the Site for a typical meteorological year. For avoidance of doubt, the purpose of this term is to provide a

short-hand characterization of the nature of the renewable resource risk assumed by the Seller under this Agreement in making its Site selection.

"Renewable Resource Variability": The variations, above and below the Renewable Resource Baseline, of the renewable resource actually available at the Site on a moment-to-moment basis. For avoidance of doubt, the purpose of this term is to provide a short-hand characterization of the nature of the renewable resource risk assumed by the Company under this Agreement in agreeing to make fixed payments in an amount calculated on the basis of the Facility's capability to deliver the Net Energy Potential regardless of whether or not sufficient renewable resource is in fact available at any particular moment.

"Required Model" or "Required Models": Shall have the meaning set forth in Section 6(a) (Seller's Obligation to Provide Models) of Attachment B (Facility Owned by Seller) of this Agreement.

"Reporting Milestones": Each of the milestones identified as such in Attachment L (Reporting Milestones).

"Revenue Metering Package": The revenue meter, revenue metering PTs and CTs, and secondary wiring

"RPS Amendment": Any amendment to the RPS subsequent to Effective Date that revises the definition of "renewable electric energy" under the RPS such that the electric energy delivered from the Facility no longer comes within such revised definition.

"RPS Modifications": Any capital improvements, additions, enhancements, replacements, repairs or other operational modifications to the Facility and/or to changes in Seller's operations or maintenance practices necessary to enable the electric energy delivered from the Facility to come within the revised definition of "renewable electrical energy" resulting from a RPS Amendment.

"RPS Modifications Document": Shall have the meaning set forth in Section 3.4(c) (RPS Modifications Document).

"RPS Pricing Impact": Any adjustment in Contract Pricing necessary to specifically reflect the recovery of the net costs and/or net lost revenues specifically attributable to any RPS Modification, which shall consist of the following: (i) recovery of, and return on, any capital investment (aa) made over a cost recovery period starting after the RPS Modification is made effective following a

PUC RPS Order through the end of the Initial Term and (bb) based on a proposed capital structure that is commercially reasonable for such an investment and the return on investment is at market rates for such an investment or similar investment); (ii) recovery of reasonably expected net additional operating and maintenance costs; and (iii) an adjustment in pricing necessary to compensate Seller for reasonably expected reductions, if any, in the delivery of electric energy to Company under this Agreement, which shall consist of (aa) an increase in payments necessary to compensate Seller for expected reduced electric energy payments under this Agreement; and (bb) to the extent applicable, an increase in payments necessary to compensate Seller for reasonably expected reductions in receipt of production tax credits (pursuant to Section 45 of the Internal Revenue Code) calculated on an after-tax basis.

"RTU" or "Remote Terminal Unit" The interface between Company's EMS and the physical equipment at the Facility.

"SCADA" or "Supervisory Control And Data Acquisition" The Company system that provides remote control and monitoring of Company's transmission and sub-transmission systems and enables Company to perform real-time control of equipment in the field and to monitor the conditions and status of the Company System.

"Second Benchmark Period": The period commencing on the first Day of the calendar month following the month during which an OEPR Evaluator issues the Initial OEPR and ending with the expiration of the third (3rd) Contract Year. For avoidance of doubt, the effect of the foregoing definition is that the Second Benchmark Period will follow immediately upon the expiration of the First Benchmark Period.

"Second NEP Benchmark": For each calendar month during the Second Benchmark Period, the estimate of Net Energy Potential to be used during such calendar month to calculate the Lump Sum Payment pursuant to Section 3.ii.a of Attachment J (Company Payments for Energy and Dispatchability) to this Agreement. For avoidance of doubt, the Second NEP Benchmark may vary during the Second Benchmark Period as and to the extent provided in said Section 3.ii.a.

"Security Funds": Shall have the meaning set forth in Section 14.6 (Security Funds).

"Seller": Shall have the meaning set forth in the preamble to this Agreement.

"Seller-Attributable Non-Generation": Time periods during which the inverter in question (or the Facility as a whole) is not dispatched or is derated or shutdown (or the Facility is disconnected) because of any of the following:

- (i) The Facility's failure to comply with any of the Performance Standards, Good Engineering and Operating Practices, Government Approvals, applicable Laws or Seller's other obligations under this Agreement;
- (ii) Seller-Attributable System Conditions;
- (iii) Conditions at or on either side of the Point of Interconnection arising from the acts or omissions of Seller or any vendor, materialmen, customer or supplier of Seller, unless such acts or omissions are themselves excused by reasons of Force Majeure pursuant to Article 21 (Force Majeure) of this Agreement;
- (iv) A disconnection initiated by the Company pursuant to Article 9 (Personnel and System Safety) of this Agreement);
- (v) The Company has decided that it is inadvisable for such inverter (or the Facility as a whole) to continue normal operations without a further Control System Acceptance Test as provided in Section 7(a) (Testing Requirements) of Attachment B (Facility Owned by Seller); or
- (vi) The Facility is deemed to be in Seller-Attributable Non-Generation status under Section 1(b)(iii)(H)(iv) of Attachment B (Facility Owned by Seller).

"Seller-Attributable System Conditions": Conditions on the Company System:

- (i) that result from either (aa) the Facility's generation and delivery of electric power to the Company System or (bb) any condition arising from the acts or omissions of Seller or any vendor, materialmen, customer or supplier or Seller, unless such acts or omissions are themselves excused by reasons of Force Majeure pursuant to Article 21 (Force Majeure) of this Agreement; and
- (ii) that Company reasonably determines to either (xx) be inconsistent with Good Engineering and Operating

Practices on the Company System or (yy) jeopardize the safety, reliability or stability of the Company System.

For avoidance of doubt, the Company's inability to dispatch the Facility due to the existence of Excess Energy Conditions on the Company System shall not constitute Seller-Attributable System Conditions.

"Seller-Owned Interconnection Facilities": The Interconnection Facilities constructed and owned by Seller.

"Seller's RPS Modifications Proposal": Shall have the meaning set forth in Section 3.4(a) (Renewable Portfolio Standards).

"Site": The parcel of real property on which the Facility will be constructed and located, together with any Land Rights reasonably necessary for the construction, ownership, operation and maintenance of the Facility. The Site is identified in Attachment A (Description of Generation and Conversion Facility) to this Agreement.

"Source Code": Shall mean the human readable source code of the Required Models which: (i) will be narrated documentation related to the compilation, linking, packaging and platform requirements and any other materials or software sufficient to enable a reasonably skilled programmer to build, modify and use the code within a commercially reasonable period of time for the purposes of a Source Code Authorized Use; and (ii) can reasonably be compiled by a computer for execution.

"Source Code Authorized Use": Shall have the meaning set forth in Section 6(b)(i)(E) (Authorized Use) of Attachment B (Facility Owned by Seller) of this Agreement.

"Source Code Escrow": Shall mean the escrow established with the Source Code Escrow Agent under the terms of the Source Code Escrow Agreement under which Source Code shall be confidentially deposited by a Source Code Owner for safekeeping and, upon the satisfaction of certain conditions, release to the Company.

"Source Code Escrow Agent": Shall mean Iron Mountain Intellectual Property Management, Inc. or such other similar escrow agent approved by Company.

"Source Code Escrow Agreement": Shall mean a multi-party escrow agreement between Company, Source Code Escrow Agent and any and all Source Code Owners depositing Source Code into the Source Code Escrow which, among other matters, names Company as beneficiary

thereunder, and is otherwise acceptable in form and substance to Company.

"Source Code Owner": Shall mean the developer and/or owner of the Required Models utilizing Source Code authorized to deposit the Source Code with the Source Code Escrow Agent upon the terms of the Source Code Escrow Agreement.

"SOX 404": Shall have the meaning set forth in Section 24.1 (Financial Compliance).

"Submission Notice": The notice issued pursuant to Section 2(c) (Submission of Monthly Report Disagreement to Independent AF Evaluator) or Section 2(d) (Submission of GPR Benchmark Disagreement to Independent AF Evaluator) of Attachment T (Monthly Reporting and Dispute Resolution by Independent AF Evaluator) to this Agreement.

"Subsequent NEP OEPR Estimate": For each Subsequent OEPR, the NEP OEPR Estimate derived from such Subsequent OEPR.

"Subsequent OEPR": Any OEPR prepared pursuant to Section 3 (Subsequent OEPRs) of Attachment U (Calculation and Adjustment of Net Energy Potential) to this Agreement.

"Term": Shall mean, collectively, the Initial Term and the Extended Term (if any).

"Termination Damages": Shall have the meaning set forth in Section 15.4 (Rights of the Non-Defaulting Party; Forward Contract) and shall be calculated in accordance with Article 16 (Damages in the Event of Termination by Company) of this Agreement.

"Termination Deadline": The 14th Day following the date the completed IRS is provided to Seller, or such later date as Company and Seller may agree to by a written agreement.

"Third Party": Any person or entity other than Company or Seller, and includes, but is not limited to, any subsidiary or affiliate of Seller.

"Tier 1 Bandwidth": Shall have the meaning set forth in Section 2.6(c) (GPR Benchmark and Liquidated Damages) of this Agreement.

"Tier 2 Bandwidth": Shall have the meaning set forth in Section 2.6(c) (GPR Benchmark and Liquidated Damages) of this Agreement.

"Total Actual Interconnection Cost": Actual costs for the Interconnection Facilities, to be designed, engineered and constructed by Company, as provided in Attachment G (Company-Owned Interconnection Facilities).

"Total Actual Relocation Cost": Shall have the meaning set forth in Section 5(b) of Attachment G (Company-Owned Interconnection Facilities).

"Total Estimated Interconnection Cost": Estimated costs for the Interconnection Facilities, to be designed, engineered and constructed by Company, as provided in Attachment G (Company-Owned Interconnection Facilities).

"Total Estimated Relocation Cost": Shall have the meaning set forth in Section 5(a) of Attachment G (Company-Owned Interconnection Facilities).

"Total Time": Shall have the meaning set forth in Section 2.5(a) (Calculation of the Availability Factor) of this Agreement.

"Transfer Date": The date, prior to the Commercial Operations Date, upon which Seller transfers to Company all right, title and interest in and to Company-Owned Interconnection Facilities to the extent, if any, that such facilities were constructed by Seller and/or its contractors.

"Unfavorable PUC Order": Shall have the meaning set forth in Section 29.20(e) (Unfavorable PUC Order).

"Unit Price": \$ [REDACTED] per [REDACTED] kWh of Net Energy Potential annually.
[TO BE CALCULATED FROM RESPONSE TO RFP.]

ATTACHMENT A
DESCRIPTION OF GENERATION AND CONVERSION FACILITY

1. Name of Facility: _____
 - (a) Location: _____ (TMK No. _____)
 - (b) Telephone number (for system emergencies):
_____-_____
_____-_____
 - (c) E-mail Address: _____
 - (d) Contact Information for notices pursuant to Section 29.3 (Notices) of the Agreement:
Mailing Address: _____
Address for Delivery by Hand or Overnight
Delivery: _____
E-Mail Address: _____

2. Owner (If different from Seller):

If Seller is not the owner, Seller shall provide Company with a certified copy of a certificate warranting that the owner is a corporation, partnership or limited liability company in good standing with the Hawai'i Department of Commerce and Consumer Affairs which shall be attached hereto as Exhibit A-1 (Good Standing Certificates).

3. Operator: _____

4. Name of person to whom payments are to be made:

 - (a) Mailing address: _____

 - (b) Hawai'i Gross Excise Tax License number: _____

5. Equipment:
 - (a) Type of facility and conversion equipment:

[For example: Small power production facility designated as a Qualifying Facility that produces electric energy using _____.]

(b) Design and capacity

Total Facility Capacity ("Contract Capacity"):
_____ kW

Total Number of Generators:

[number and size of each generator. e.g. one (1) Brand X, 200 kW; one (1) Brand Y, 300 kW]

Description of Equipment:

[For example: Describe the type of energy conversion equipment, capacity, and any special features.]

Individual unit: **[if more than one generator, list information for each generator]**

	kW	kVAR Consumed	kVAR Produced
<u>Full load</u>			
<u>Startup</u>			

Generator:

Type _____

Rated Power _____ kW

Voltage _____ V, _____ phase

Frequency _____ HZ

Class of Protection _____

Number of Poles _____

Rated Speed _____ rpm

Rated Current _____ A

Rated Power Factor See Exhibit B-2

(c) Single or 3 phase: _____ phase

(d) Name of manufacturer:

- (e) The "Allowed Capacity" of this Agreement shall be the lower of (i) Contract Capacity or (ii) the net nameplate capacity (net for export) of the Facility installed by the Commercial Operations Date.
- (f) Seller may propose revisions to this Section 5 (Equipment) of Attachment A (Description of Generation and Conversion Facility) ("Section 5") for Company's approval prior to commencement of construction, provided, however, that (i) no such revision to this Section 5 shall change the type of Facility or conversion equipment deployed at the Facility from a solar energy conversion facility using photovoltaic equipment; (ii) Seller shall be in compliance with all other terms and conditions of this Agreement; and (iii) such revision(s) shall not change the characteristics of the Facility equipment or the specifications used in the IRS. Any revision to this Section 5 complying with items (i) through (iii) above shall be subject to Company's prior approval, which approval shall not be unreasonably withheld. If Seller's proposed revision(s) to this Section 5 otherwise satisfies items (i) and (ii) above but not item (iii) such that Company, in its reasonable discretion, determines that a re-study or revision to all or any part of the IRS is required to accommodate Seller's proposed revision(s), Company may, in its sole and absolute discretion, conditionally approve such revision(s) subject to a satisfactory re-study or revision to the IRS and Seller's payment and continued obligation to be liable and responsible for all costs and expenses of re-studying or revising such portions of the IRS and for modifying and paying for all costs and expenses of modification to the Facility, the Company-Owned Interconnection Facilities based on the results of the re-studies or revisions to the IRS. Any changes made to this Attachment A (Description of Generation and Conversion Facility) or the Agreement as a result of this Section 5(f) of Attachment A (Description of Generation and Conversion Facility) shall be reflected in a written amendment to the Agreement.

Seller understands and acknowledges that Company's review and approval of Seller's proposed revisions

to this Section 5 and any necessary re-studies or revisions to the IRS shall be subject to Company's then-existing time and personnel constraints. Company agrees to use commercially reasonable efforts, under such time and personnel constraints, to complete any necessary reviews, approvals and/or re-studies or revisions to the IRS.

Any delay in completing, or failure by Seller to meet, any subsequent Seller milestones under Article 13 (Guaranteed Project Milestones Including Commercial Operations) as a result of any revision pursuant to this Section 5 by Seller (whether requiring a re-study or revision to the IRS or not) shall be borne entirely by Seller and Company shall not be responsible or liable for any delay or failure to meet any such milestones by Seller.

6. Insurance carrier(s): **[SELLER TO PROVIDE INFORMATION]**
7. If Seller is not the operator, Seller shall provide a copy of the agreement between Seller and the operator which requires the operator to operate the Facility and which establishes the scope of operations by the operator and the respective rights of Seller and the operator with respect to the sale of electric energy from Facility no later than the Commercial Operations Date. In addition, Seller shall provide a certified copy of a certificate warranting that the operator is a corporation, partnership or limited liability company in good standing with the Hawai'i Department of Commerce and Consumer Affairs no later than the Commercial Operations Date.
8. Seller shall provide a certified copy of a certificate warranting that Seller is a corporation, partnership or limited liability company in good standing with the Hawai'i Department of Commerce and Consumer Affairs which shall be attached hereto as Exhibit A-1 (Good Standing Certificates).
9. Seller, owner and operator shall provide Company a certificate and/or description of their ownership structures which shall be attached hereto as Exhibit A-2 (Ownership Structure).
10. In the event of a change in ownership or identity of Seller, owner or operator, such entity shall provide within 30 Days thereof, a certified copy of a new certificate and a revised ownership structure.

EXHIBIT A-1
GOOD STANDING CERTIFICATES

EXHIBIT A-2
OWNERSHIP STRUCTURE

**[ATTACHMENT B WILL BE REVISED TO REFLECT
THE RESULTS OF IRS]**

ATTACHMENT B
FACILITY OWNED BY SELLER

1. The Facility.

(a) Drawings, Diagrams, Lists, Settings and As-Builts.

- (i) Single-Line Drawing, Interface Block Diagram, Relay List, Relay Settings and Trip Scheme. A preliminary single-line drawing (including notes), Interface Block Diagram, relay list, relay settings, and trip scheme of the Facility shall, after Seller has obtained prior written consent from Company, be attached to this Agreement on the Execution Date as Attachment E (Single-Line Drawing and Interface Block Diagram) and Attachment F (Relay List and Trip Scheme). A final single-line drawing (including notes), Interface Block Diagram, relay list and trip scheme of the Facility shall, after having obtained prior written consent from Company, be labeled "Final" Single-Line Drawing, the "Final" Interface Block Diagram and "Final" Relay List and Trip Scheme and shall supersede Attachment E (Single-Line Drawing and Interface Block Diagram) and Attachment F (Relay List and Trip Scheme) to this Agreement and shall be made a part hereof on the Commercial Operations Date. After the Commercial Operations Date, no changes shall be made to the "Final" Single-Line Drawing, the "Final" Interface Block Diagram and the "Final" Relay List and Trip Scheme without the prior written consent of Seller and Company. The single-line drawing shall expressly identify the Point of Interconnection of Facility to Company System.
- (ii) As-Builts. Seller shall provide final as-built drawings of the Seller-Owned Interconnection Facilities within 30 Days of the successful completion of the Acceptance Test.
- (iii) No Material Changes. Seller agrees that no material changes or additions to Facility as

reflected in the "Final" Single-Line Drawing (including notes), the "Final" Interface Block Diagram and the "Final" Relay List and Trip Scheme, shall be made without Seller first having obtained prior written consent from Company. The foregoing are subject to changes and additions as part of any Performance Standards Modifications. If Company directs any changes in or additions to the Facility, records and operating procedures that are not part of any Performance Standards Modifications, Company shall specify such changes or additions to Seller in writing, and, except in the case of an emergency, Seller shall have the opportunity to review and comment upon any such changes or additions in advance.

(b) Certain Specifications for the Facility.

(i) Seller shall furnish, install, operate and maintain the Facility including breakers, relays, switches, synchronizing equipment, monitoring equipment and control and protective devices approved by Company as suitable for parallel operation of the Facility with Company System. The Facility shall be accessible at all times to authorized Company personnel.

(ii) The Facility shall include:

[LIST OF THE FACILITY

Examples may include, but not limited to:

- **Seller-Owned Interconnection Facilities**
- **Substation**
- **Control and monitoring facilities**
- **Transformers**
- **Generators (as described in Attachment A)**
- **"lockable" cabinets or housings suitable for the installation of the Company-Owned Interconnection Facilities located on the Site**
- **relays and other protective devices**
- **leased telephone line and/or equipment to facilitate microwave communication]**

- (iii) The Facility shall comply with the following **[includes excerpts of language that may be requested by Company]**:
- A. Seller shall install a _____ kV disconnect switch and all other items for its switching station (relaying, control power transformers, high voltage circuit breaker). Bus connection shall be made to a manually and automatically (via protective relays) operated high-voltage circuit breaker. The high-voltage circuit breaker shall be fitted with bushing style current transformers for metering and relaying. Downstream of the high-voltage circuit breaker, a structure shall be provided for metering transformers. From the high-voltage circuit breaker, another bus connection shall be made to another pole mounted disconnect switch, with surge protection.
 - B. Seller shall provide within the Seller-Owned Interconnection Facilities a separate, fenced area with separate access for Company. Seller shall provide all conduits, structures and accessories necessary for Company to install the Revenue Metering Package. Seller shall also provide within such area, space for Company to install its communications, supervisory control and data acquisition ("SCADA") remote terminal unit ("RTU") and certain relaying if necessary for the interconnection. Seller shall also provide AC and DC source lines as specified later by Company. Seller shall provide a telephone line for Company-owned meters. Seller shall work with Company to determine an acceptable location and size of the fenced-in area. Seller shall provide an acceptable demarcation cabinet on its side of the fence where Seller and Company wiring will connect/interface.
 - C. Seller shall ensure that the Seller-Owned Interconnection Facilities has a lockable

cabinet for switching station relaying equipment. Seller shall select and install relaying equipment acceptable to Company. At a minimum the relaying equipment will provide over and under frequency (81) negative phase sequence (46), under voltage (27), over voltage (59), ground over voltage (59G), over current functions (50/51) and direct transfer trip. Seller shall install protective relays that operate a lockout relay, which in turn will trip the main circuit breaker.

- D. Seller shall configure the relay protection system to provide overpower protection to enable Facility to comply with the Allowed Capacity limitation.
- E. Seller's equipment also shall provide at a minimum:
 - (i) Interface with Company's RTU to provide telemetry of electrical quantities such as total Facility net MW, MVar, power factor, voltages, currents, and other quantities as identified by the Company;
 - (ii) Interface with Company's RTU to provide status for circuit breakers, reactive devices, switches, and other equipment as identified by the Company;
 - (iii) Interface with Company's RTU to provide control to incrementally raise and lower the voltage target at the point of regulation operating in automatic voltage regulation control. If Company's RTU is unavailable, due to loss of communication link, RTU failure, or other event resulting in loss of the remote control by Company, provision

must be made for Seller to be able to institute via local controls, within 30 minutes (or such other period as Company accepts in writing) of the verbal directive by the Company System Operator, such change in voltage regulation target as directed by the Company System Operator;

(iv) Interface with Company's RTU to provide active power control to incrementally limit net real power export from the Facility and to incrementally remove the limit of the net real power export of the Facility. The incremental size will be determined as part of the Interconnection Requirements Study taking into account the size of the Facility and the dynamic system frequency bias; and

(v) For PV Facilities: Interface with Company's RTU to provide telemetry of inverter availability and meteorological and production data required under Section 8 (Data and Forecasting) of this Attachment B (Facility Owned by Seller) and the Facility's Power Possible.

F. If Seller adds, deletes and/or changes any of its equipment, or changes its design in a manner that would change the characteristics of the equipment and specifications used in the IRS, Seller shall be required to obtain Company's prior written approval. If an analysis to revise parts of the IRS is required, Seller shall be responsible for the cost of revising those parts of the IRS, and modifying and paying for the cost of the

modifications to the Facility and/or the Company-Owned Interconnection Facilities based on the revisions to the IRS.

G. Critical Infrastructure Protection.

(i) Documentation. Seller shall submit documentation describing the approach, methodology and design to provide physical and cyber security with its submittal of the design drawings pursuant to Section 1(c) (Design Drawings, Bill of Materials, Relay Settings and Fuse Selection) of Attachment B (Facility Owned by Seller) which shall be at least sixty (60) Days prior to the Acceptance Test.

- The design shall meet industry standards and best practices, as indicated by NERC CIP guidelines and requirements for critical generation facilities. The system shall be designed with the criteria to meet applicable industry standards and guidelines (at the time of this writing, NERC CIP, or any future standard adopted by the industry in its place) compliance requirements and identify areas that are not consistent with NERC CIP guidelines and requirements.
- The cyber-security documentation shall include a block diagram of the control system with all external connections clearly described.
- Seller shall provide such additional information as Company may reasonably request as part of a security posture assessment.
- Company shall be notified in advance when there is any condition

that would compromise physical or cyber security, or if any breaches in security, or security incidents are detected.

- (ii) Malware. Seller shall (consistent with the following sentence) ensure that no malware or similar items are coded or introduced into any aspect of the Facility, Interconnection Facilities, the Company Systems interfacing with the Facility and Interconnection Facilities, and any of Seller's critical control systems or processes used by Seller to provide energy, including the information, data and other materials delivered by or on behalf of Seller to Company, (collectively, the "Environment"). Seller will continue to review, analyze and implement improvements to and upgrades of its Malware prevention and correction programs and processes that are commercially reasonable and consistent with the then current technology industry's standards and, in any case, not less robust than the programs and processes implemented by Seller with respect to its own information systems. If Malware is found to have been introduced into the Environment, Seller will promptly notify Company and Seller shall take immediate action to eliminate and remediate the effects of the Malware, at Seller's expense. Seller shall not modify or otherwise take corrective action with respect to the Company Systems except at Company's request. Seller will promptly report to Company the nature and status of all Malware elimination and remediation efforts.

- (iii) Security Breach. In the event that Seller discovers or is notified of a breach, potential breach of security, or security incident at Seller's Facility or of Seller's systems, Seller shall immediately (i) notify Company of such potential, suspected or actual security breach, whether or not such breach has compromised any of Company's confidential information, (ii) investigate and promptly remediate the effects of the breach, whether or not the breach was caused by Seller, (iii) cooperate with Company with respect to any such breach or unauthorized access or use; (iv) comply with all applicable privacy and data protection laws governing Company's or any other individual's or entity's data; and (v) to the extent such breach was caused by Seller, provide Company with reasonable assurances satisfactory to Company that such breach, potential breach, or security incident shall not recur. Seller shall provide documentation to Company evidencing the length and impact of the breach. Any remediation of any such breach will be at Seller's sole expense.
- (iv) Monitoring and Audit. Seller's shall provide information on available audit logs and reports relating to cyber and physical and security. Company may audit Seller's records to ensure Seller's compliance with the terms of this Section 1(b)(iii)G (Critical Infrastructure Protection) of this Attachment B (Facility Owned by Seller), provided that Company has provided reasonable notice to Seller and any such records of Seller's

will be treated by Company as confidential.

H. Because a reliable Power Possible value under Section 1(b)(iii)(E)(v) of this Attachment B (Facility Owned by Seller) is necessary throughout the Term in order for Company to effectively optimize the benefits of its right of Company Dispatch, it is the expectation of the Parties that the model and data inputs used by the Seller to calculate Power Possible will be validated during the Evaluation Periods described below as more fully set forth below.

(i) The relationship between the 15-minute averaged Power Possible value and the Facility's 15-minute averaged actual power production at the Point of Interconnection shall be evaluated in 15-minute intervals for periods described below. The periods eligible for such evaluation (each such period an "Eligible Period") are periods during which both of the following conditions continuously apply for a duration of not less than 60 consecutive minutes: (aa) the Facility is in unconstrained operations; and (bb) the plane of array irradiance is not less than 600 W/m^2 . For avoidance of doubt, the aforementioned 60-minute minimum is not a cap on the duration of an Eligible Period, which shall continue for as long as the two conditions set forth in the preceding sentence continuously apply. Each period for which the relationship between the 15-minute averaged Power Possible value and the 15-minute averaged actual power

production will be evaluated (each such period an "Evaluation Period") shall commence upon the satisfaction of one or the other of the following two conditions: (i) if an Eligible Period commences because the plane of array irradiance equals or exceeds 600 W/m^2 (i.e., the Facility was already in unconstrained operations at the time the irradiance threshold is reached), such Evaluation Period shall commence when the plane of array threshold is reached and shall consist of all of the consecutive 15-minute intervals that are encompassed within such Eligible Period; and (ii) if an Eligible Period commences because the Facility's set point is increased to not less than the Allowed Capacity, such Evaluation Period shall commence 15 minutes after such change in set point and shall consist of all of the consecutive 15-minute intervals that are encompassed within the balance of such Eligible Period;

- (ii) An Evaluation Period shall constitute a Power Possible Discrepancy Period if, for any one or more 15-minute intervals during such Evaluation Period, the 15-minute averaged Power Possible value for such interval is outside of a band of plus or minus 4% of the 15-minute averaged actual power production at the Point of Interconnection for that same interval.

- (iii) Upon the occurrence of a Power Possible Discrepancy Period, Seller shall promptly investigate the reason why the bandwidth was exceeded, take such action as may be necessary to improve Seller's model and data inputs for calculating Power Possible with the objective of avoiding future Power Possible Discrepancy Periods, and provide to Company, within thirty (30) Days of the occurrence of the Power Possible Discrepancy Period in question, a written report of both the results of such investigation and the action taken by Seller.
- (iv) If, at any time during the Term, four consecutive Evaluation Periods each constitute a Power Possible Discrepancy Period: (aa) the model and data inputs used by Seller to calculate Power Possible shall be considered to be invalidated and the Parties shall promptly commission a study to be performed by one of the engineering firms then included on the OEPR Consultants List to evaluate the cause of the Power Possible Discrepancy Periods and to make recommendations with the objective of avoiding future Power Possible Discrepancy Periods ("Study"); and (bb) if the Company decides that its ability to effectively optimize the benefits of its right of Company Dispatch to dispatch the Facility's Net Energy Potential is materially

impaired by the lack of a validated Power Possible model and data inputs, the Company shall have the right to derate the Facility and the Facility shall be deemed to be in Seller-Attributable Non-Generation status until the Study has been completed and the Study's recommendations have been implemented by Seller to Company's reasonable satisfaction. Seller shall pay for the cost of the Study. The Study shall be completed within ninety (90) days from such fourth consecutive Power Possible Discrepancy Period, unless otherwise agreed to in writing by Seller and Company. The Consultant shall send the Study to Company and Seller. Seller (and/or its Third-Party consultants and contractors), at Seller's expense, shall take such action as the Study shall recommend (e.g., modifications to the model, modifications and/or additions to the data inputs used in the model, modifications to the procedures for maintaining and/or recalibrating the Monitoring and Communication Equipment used to provide data inputs, replacement of such Monitoring and Communication Equipment, modifications of procedures for Facility operations) with the objective of avoiding future Power Possible Discrepancy Periods. Such recommendations shall be implemented by Seller to Company's reasonable satisfaction no later than forty-five (45) Days from the Day the completed Study is

issued by the consultant,
unless otherwise agreed to in
writing by Company.

- I. Seller shall reserve space within the Site for possible future installation of Company-owned meteorological equipment (such as SODAR and irradiance monitors) and AC and DC source lines for such equipment. In the event Company decides to install such meteorological equipment: (i) Seller shall work with Company to determine an acceptable location for such equipment and any associated wiring, interface or other components; and (ii) Company shall pay for the needed equipment, and installation of such equipment, unless otherwise agreed to by the Parties. Company and Seller shall use commercially reasonable efforts to facilitate installation and minimize interference with the operation of the Facility.
- J. The Facility shall, at a minimum, satisfy the wind load and seismic load requirements of the International Building Code and any more stringent requirements imposed under applicable Laws.
- (c) Design Drawings, Bill of Materials, Relay Settings and Fuse Selection. Seller shall provide to Company for its review the design drawings, Bill of Material, relay settings and fuse selection for the Facility and Company shall have the right, but not the obligation, to specify the type of electrical equipment, the interconnection wiring, the type of protective relaying equipment, including, but not limited to, the control circuits connected to it and the disconnecting devices, and the settings that affect the reliability and safety of operation of Company's and Seller's interconnected system. Seller shall provide the relay settings, fuse selection, and AC/DC Schematic Trip Scheme (part of design drawings) for the Facility to Company at least sixty (60) Days prior to the Acceptance Test. Company, at its

option, may, with reasonable frequency, witness Seller's operation of control, synchronizing, and protection schemes and shall have the right to periodically re-specify the settings. Seller shall utilize relay settings prescribed by Company, which may be changed over time as Company System requirements change.

- (d) Disconnect Device. Seller shall provide a manually operated disconnect device which provides a visible break to separate Facility from Company System. Such disconnect device shall be lockable in the OPEN position and be readily accessible to Company personnel at all times.
- (e) Other Equipment. Seller shall install, own and maintain the infrastructure associated with the Revenue Metering Package, including but not limited to all enclosures (meter cabinets, meter pedestals, meter sockets, pull boxes, and junction boxes, along with their grounding/bonding connections), CT/PT mounting structures, conduits and ductlines, enclosure support structures, ground buses, pads, test switches, terminal blocks, isolation relays, telephone surge suppressors, and analog phone lines (one per meter), subject to Company's review and approval. **[COMPANY TO REVISE THIS SECTION 1(E) PRIOR TO EXECUTION FOR SPECIFICS OF THE PROJECT.]**
- (f) Maintenance Plan. Seller shall maintain Seller-Owned Interconnection Facilities in accordance with the following maintenance plan:

Transmission line: [REDACTED]

[REDACTED] kV Facility switching station:
[REDACTED]

Relay protection equipment: [REDACTED]

Other equipment as identified: [REDACTED]

Seller shall furnish to Company a copy of records documenting such maintenance, within thirty (30) Days of completion of such maintenance work.

- (g) Active Power Control Interface.

- (i) Seller shall provide and maintain in good working order all equipment, computers and software associated with the control system (the "Active Power Control Interface") necessary to interface the Facility active power controls with the Company System Operations Control Center for real power control of the Facility by the Company System Operator. The Active Power Control Interface will be used to control the maximum level of the net real power export from the Facility when required under this Attachment B (Facility Owned by Seller). The implementation of the Active Power Control Interface will allow Company System Operator to initiate the active power limiting, vary the level of limiting, and remove the limiting remotely from Company System Operations Control Center through control signals from Company's SCADA and EMS systems.
- (ii) Company shall review and provide prior written approval of the design for the Active Power Control Interface to ensure compatibility with Company's SCADA and EMS systems. In order to ensure such continued compatibility, Seller shall not materially change the approved design without Company's prior review and prior written approval.
- (iii) The Active Power Control Interface shall include, but not be limited to, a demarcation cabinet, ancillary equipment and software necessary for Seller to connect to Company's RTU, located in Company's portion of the Facility switching station which shall provide the control signals to the Facility and send feedback status to the Company System Operations Control Center. The control type shall be analog output (set point) controls.
- (iv) The Active Power Control Interface shall also include provision for feedback points from the Facility indicating when active power limiting is in effect and the analog value of the MW limit(s). The Facility shall provide the feedback to the Company SCADA system

within 2 seconds of receiving the respective control signal from the Company.

- (v) Seller shall provide an analog input to the RTU for the MW output of the individual generating units, and an analog signal for the total MW output at the Point of Interconnection.
- (vi) The Active Power Control Interface shall provide for remote control of the real-power output of the Facility by the Company at all times. If the Active Power Control Interface is unavailable or disabled, the Facility shall not export electric energy to Company, unless the Company, in its sole discretion, agrees to accept electric energy and Seller and Company agree on an alternate means of dispatch. Notwithstanding the foregoing, if Seller fails to provide such remote control features (whether temporarily or throughout the Term) and fails to discontinue exporting electric energy to Company as required by this Section 1(g)(vi), then, notwithstanding any other provision of this Attachment B (Facility Owned by Seller), Company shall have the right to derate or disconnect the entire Facility during those periods that such control features are not provided.
- If all local and remote active power controls become unavailable or fail, the Facility shall immediately disconnect from the Company's System.
 - If the direct transfer trip is unavailable due to loss of communication link, RTU failure, or other event resulting in the loss of the remote control by the Company, provision must be made for the Seller to trip the main circuit breaker.
- (vii) The rate at which the Facility changes net real power export shall not exceed the ramp rate specified in Section 3(c) (Ramp Rate) of Attachment B (Facility Owned by Seller). The Facility's Active Power Control Interface

will control the rate at which electric energy is changed to achieve the active power limit. The Facility will respond to the active power control request immediately.

[THESE REQUIREMENTS MAY BE CHANGED BY COMPANY FOLLOWING COMPLETION OF THE IRS]

- (viii) The Active Power Control Interface shall accept the following active power control(s) from the Company SCADA and EMS systems:
- **Maximum Power Limit:** The Facility is not allowed to exceed this setting under any circumstances. The frequency response control specified in Section 3(m) (Frequency Response) of Attachment B (Facility Owned by Seller) is not allowed to increase the Facility's net real power export above this limit. When the Maximum Power Limit is set to zero, the Facility inverters must be shutdown. **subject to Company review].**
 - **Power Reference Limit:** The Facility is not allowed to exceed this setting when system frequency is at 60 Hz. When system frequency is not 60 Hz, the Facility's net real power export is allowed to exceed this setting or be further reduced below this setting when commanded by the frequency response control specified in Section 3(m) of Attachment B (Facility Owned by Seller).
- (ix) Seller shall not override Company's active power controls without first obtaining specific approval to do so from the Company System Operator.
- (x) The requirements of the Active Power Control Interface may be modified as mutually agreed upon in writing by the Parties.
- (h) Control System Acceptance Test Procedures.
- (i) Conditions Precedent. The following conditions precedent must be satisfied prior to the conduct of the Control System Acceptance Test:

- Successful Completion of the Acceptance Test.
 - Facility has been successfully energized.
 - All of the Facility's generators have been fully commissioned.
 - The control system computer has been programmed for normal operations.
 - All equipment that is relied upon for normal operations (including ancillary devices such as capacitors/inductors, energy storage device, statcom, etc.) shall have been commissioned and be operating within normal parameters.
- (ii) Facility Generators. Unless all of the Facility's generators are available for the duration of the Control System Acceptance Test, the Control System Acceptance Test will have to be re-run from the beginning unless Seller demonstrates to the satisfaction of the Company that the test results attained with less than all of the Facility's generators are consistent with the results that would have been attained if all of the Facility's generators had been available for the duration of the test.
- (iii) Procedures. The Control System Acceptance Test will be conducted on Business Days during normal working hours on a mutually agreed upon schedule. No Control System Acceptance Test will be scheduled during the final 21 Days of a calendar year. No later than thirty (30) Days prior to conducting the Control System Acceptance Test, Company and Seller shall agree on a written protocol setting out the detailed procedure and criteria for passing the Control System Acceptance Test. Attachment O (Control System Acceptance Test Criteria) provides general criteria to be included in the written protocol for the Control System Acceptance Test. Within fifteen (15) Business Days of completion of the Control System Acceptance Test, Company shall notify Seller in writing whether the Control System Acceptance Test(s) has been passed and, if so, the date upon which such Control System Acceptance Test(s) was passed. If any changes have been made to the technical specifications of the Facility or the design of

the Facility in accordance with Section 5(f) of Attachment A (Description of Generation and Conversion Facility), such changes shall be reflected in an amendment to this Agreement, and the written protocol for the Control Systems Acceptance Test shall be based on the Facility as modified. Such Amendment shall be executed prior to conducting the Control System Acceptance Test and Company shall have no obligation for any delay in performing the Control Systems Acceptance Test due to the need to complete and execute such amendment.

- (i) Facility Security and Maintenance. Seller is responsible for securing the Facility. Seller shall have personnel available to respond to all calls related to security incidents and shall take commercially reasonable efforts to prevent any security incidents. Seller is also responsible for maintaining the Facility, including vegetation management, to prevent security breaches. Seller shall comply with all commercially reasonable requests of Company to update security and/or maintenance if required to prevent security breaches.
- (j) Demonstration of Facility. Company shall have the right at any time, other than during maintenance or other special conditions communicated by Seller, to notify Seller in writing of Seller's failure, as observed by Company and set forth in such written notice, to meet the operational and performance requirements specified in Section 1(g) (Active Power Control Interface) and Section 3 (Performance Standards) of this Attachment B (Facility Owned by Seller), and to require documentation or testing to verify compliance with such requirements. Upon receipt of such notice, Seller shall promptly investigate the matter, implement corrective action and provide to Company, within thirty (30) Days of such notice, a written report of both the results of such investigation and the corrective action taken by Seller. If the Seller's report does not resolve the issues to Company's reasonable satisfaction, the Parties shall promptly commission a study to be performed by one of the engineering firms then included on the OEPR Consultants List to evaluate the cause of the non-compliance and to make recommendations to remedy such non-compliance.

Seller shall pay for the cost of the study. The study shall be completed within ninety (90) days, unless otherwise agreed to in writing by Seller and Company. The consultant shall send the study to Company and Seller. Seller (and/or its Third-Party consultants and contractors), at Seller's expense, shall take such action as the study shall recommend with the objective of resolving the non-compliance. Such recommendations shall be implemented by Seller to Company's reasonable satisfaction no later than forty-five (45) Days from the Day the completed study is issued by the consultant, unless otherwise agreed to in writing by Company. Failure to implement such recommendations within this period shall constitute a material breach of this Agreement.

2. Operating Procedures. **[NOTE: NUMERICAL SPECIFICATIONS IN THIS SECTION 2 MAY VARY DEPENDING ON THE SPECIFIC PROJECT AND THE RESULTS OF THE PROJECT SPECIFIC INTERCONNECTION REQUIREMENT STUDY.]**

- (a) Reviews of the Facility. Company may require periodic reviews of the Facility, maintenance records, available operating procedures and policies, and relay settings, and Seller shall implement changes Company deems necessary for parallel operation or to protect the Company System from damages resulting from the parallel operation of the Facility with the Company System.
- (b) Separation. Seller must separate from Company System whenever requested to do so by the Company System Operator pursuant to Article 8 (Company Dispatch) and Article 9 (Personnel and System Safety) of the Agreement.
- (c) Seller Logs. Logs shall be kept by Seller for information on unit availability including reasons for planned and forced outages; circuit breaker trip operations, relay operations, including target initiation and other unusual events. Company shall have the right to review these logs, especially in analyzing system disturbances. Seller shall maintain such records for a period of not less than six (6) years.
- (d) Reclosing. Under no circumstances shall Seller, when separated from the Company System for any reason,

reclose into the Company System without first obtaining specific approval to do so from the Company System Operator.

- (e) Reserved.
- (f) Reserved.
- (g) Critical Infrastructure Protection. Seller shall comply with the critical infrastructure protection requirements set forth in Section 1(b)(iii)G of this Attachment B (Facility Owned by Seller).
- (h) Allowed Operations. Facility shall be allowed to export energy to the Company System only when the [_____] circuit is in normal operating configuration served by breaker [_____] at [_____] Substation. **[TO BE DETERMINED BY COMPANY BASED ON THE RESULTS AND REQUIREMENTS OF THE IRS]**

3. Performance Standards.

(a) Reactive Power Control. Seller shall control its reactive power by automatic voltage regulation control. Seller shall automatically regulate voltage at a point, the point of regulation, between the Seller's generator terminal and the Point of Interconnection to be specified by Company, to within 0.5% of a voltage specified by the Company System Operator to the extent allowed by the Facility reactive power capabilities as defined in Section 3(b)(Reactive Amount) of this Attachment B (Facility Owned by Seller). **[FOR FACILITIES CONNECTED TO THE DISTRIBUTION SYSTEM, THESE REQUIREMENTS MAY BE CHANGED BY COMPANY UPON COMPLETION OF THE IRS.]**

(b) Reactive Amount. **[THESE REQUIREMENTS MAY BE CHANGED BY COMPANY UPON COMPLETION OF THE IRS.]**

- (i) Seller shall install sufficient equipment so that each [REDACTED] kVA **inverter** online at the Facility will have the ability to deliver or receive, at its terminal, reactive power as illustrated in the **[generator capability]** curve[s] attached to this Agreement as Exhibit B-2 (Generator Capability Curve(s)). **[NOTE: THE IRS WILL DETERMINE IF ANY ADDITIONAL REACTIVE POWER RESOURCES WILL BE REQUIRED.]**

- (ii) The Facility shall contain equipment able to continuously and actively control the output of reactive power under automatic voltage regulation control reacting to system voltage fluctuations. The automatic voltage regulation response speed at the point of regulation shall be such that at least 90% of the initial voltage correction needed to reach the voltage control target will be achieved within 1 second following a step change.
- (iii) If the Facility does not operate in accordance with Section 3(b)(i) of this Attachment B (Facility Owned by Seller), Company may disconnect all or a part of Facility from Company System until Seller corrects its operation (such as by installing capacitors at Seller's expense).
- (c) Ramp Rates.
- (i) Seller shall ensure that the ramp rate of the Facility is less than the following limits for all conditions including start up, normal operations, Seller adjusting the Facility Actual Output, changes in the **solar** resource, and shut down (including high wind speed shut down in the case of wind facilities) for the following periods as calculated in accordance with Attachment C (Methods and Formulas For Measuring Performance Standards).
- Maximum Ramp Rate Upward of [] MW/minute for all periods. **[TO BE DETERMINED FOLLOWING IRS.]**
 - Maximum Ramp Rate Downward of 2 MW/minute for all periods other than periods for which such maximum is not operationally possible because of rapid loss of **solar** resource.
- (ii) Upon receiving a command from the Company active power limit control(s) described in Section 1(g)(viii) of this Attachment B (Facility Owned by Seller), Seller shall adjust the Facility's net real power export at a ramp rate, as calculated in accordance with Attachment C (Methods and Formulas for Measuring Performance Standards), to be specified by the Company to the extent allowed by the **solar** resource without exceeding such ramp rate

and without intentional delay. Such ramp rate shall be in the range of [redacted] MW/min to [redacted] MW/min.

(iii) The Facility is allowed to exceed the maximum ramp rate limits in Section 3(c) (Ramp Rates) of this Attachment B (Facility Owned by Seller) when Facility output is changed by the frequency response control described in Section 3(m) (Frequency Response) of this Attachment B (Facility Owned by Seller).

(d) Reserved.

(e) Undervoltage Ride-Through.

The Facility, as a whole, will meet the following undervoltage ride-through requirements during low voltage affecting one or more of the three voltage phases ("V" is the voltage of any three voltage phases at the Point of Interconnection). **[THESE VALUES MAY BE CHANGED BY COMPANY UPON COMPLETION OF THE IRS. WITHOUT LIMITATION, FOR A DISTRIBUTION-CONNECTED FACILITY, UPON COMPLETION OF THE IRS THE COMPANY MAY SPECIFY REQUIREMENTS FOR A MANDATORY DISCONNECTION FROM THE COMPANY SYSTEM.]**:

$0.88 \text{ pu} \leq V \leq 1.00 \text{ pu}$	The Facility remains connected to the Company System.
$0.70 \text{ pu} \leq V < 0.88 \text{ pu}$	The Facility may initiate disconnection from the Company System if the voltage remains in this range for more than 20 seconds.
$0.50 \text{ pu} \leq V < 0.70 \text{ pu}$	The Facility may initiate disconnection from the Company System if the voltage remains in this range for more than 10 seconds.
$0.00 \text{ pu} \leq V < 0.50 \text{ pu}$	The Facility may disconnection from the Company System if voltage remains in this range for more than 600 milliseconds.

Seller shall have sufficient capacity to fulfill the above mentioned requirements to ride-through the following sequences or combinations thereof **[THE ACTUAL CLEARING TIMES WILL BE DETERMINED BY COMPANY IN CONNECTION WITH THE IRS]**:

- Normally cleared 138 kV transmission faults cleared after 5 cycles with one reclose attempt, cleared in 5 cycles, 30 cycles after the initial fault was cleared. The voltage at the Point of Interconnection will recover above the 0.80 p.u. level for the 30 cycles between the initial clearing time and the reclosing time.
- Normally cleared 46kV subtransmission faults cleared in 7 cycles with one reclose attempt, cleared in 7 cycles, 23 cycles after the initial fault was cleared. The voltage at the Point of Interconnection will recover above the 0.80 p.u. level for the 23 cycles between the initial clearing time and the reclosing time.

(f) Over Voltage Ride-Through.

The overvoltage protection equipment at the Facility shall be set so that the Facility will meet the following overvoltage ride-through requirements during high voltage affecting one or more of the three voltage phases (as described below) ("V" is the voltage of any of the three voltage phases at the Point of Interconnection). **[THESE VALUES MAY BE CHANGED BY THE COMPANY UPON COMPLETION OF THE IRS. WITHOUT LIMITATION, FOR A DISTRIBUTION-CONNECTED FACILITY, UPON COMPLETION OF THE IRS THE COMPANY MAY SPECIFY REQUIREMENTS FOR A MANDATORY DISCONNECTION FROM THE COMPANY SYSTEM AT $V > 1.2$ pu. RIDE-THROUGH REQUIREMENTS FOR OTHER SYSTEMS WILL BE DETERMINED IN THE IRS.]**:

1.00 pu < V ≤ 1.10 pu The Facility remains connected to the Company System.

1.10 pu < V ≤ 1.20 pu The Facility may initiate disconnection from the Company System if voltage remains in this range for more 0.92 seconds.

$V > 1.2 \text{ pu}$

The Facility may initiate disconnection from the Company System immediately.

(g) [RESERVED]

(h) Fault Ride Through.

For fault-related voltage dips at the Point of Interconnection that stay within the limits of the under voltage ride-through requirements in Section 3(e) (Undervoltage Ride Through) of this Attachment B (Facility Owned by Seller), upon clearing of the fault, Seller shall within 1 second of restoration, provide at least 90% of the real power output at the Point of Interconnection immediately before the fault without regard to the ramp rate requirements of Section 3(c) (Ramp Rates) of this Attachment B (Facility Owned by Seller) to the extent allowed by the availability of the **solar** resource. The fault ride through requirement does not apply if the Facility is operating at less than five percent (5%) of the Facility's nameplate capacity.

(i) Underfrequency ride-through.

The Facility shall meet the following underfrequency ride-through requirements during an underfrequency disturbance ("f" is the Company System frequency at the Point of Interconnection):

$57.0 \text{ Hz} \leq f \leq 60.0 \text{ Hz}$

The Facility remains connected to the Company System.

$56.0 \text{ Hz} \leq f \leq 57.0 \text{ Hz}$

The Facility may initiate disconnection from the Company System if frequency remains in this range for more than 20 seconds.

$f < 56.0 \text{ Hz}$

The Facility may initiate disconnection from the Company System immediately.

(j) Overfrequency ride-through.

The Facility will behave as specified below for overfrequency conditions ("f" is the Company System frequency at the Point of Interconnection):

60.0 Hz \leq f \leq 63.0 Hz The Facility remains connected to the Company System.

63.0 Hz \leq f \leq 64.0 Hz The Facility shall initiate disconnection from the Company System if frequency remains in this range for more than 20 seconds.

f > 64.0 Hz The Facility shall initiate disconnection from the Company System immediately.

(k) Voltage Flicker.

Any voltage flicker on the Company System caused by the Facility shall not exceed the limits stated in IEEE Standard 1453-2011, or latest version "Recommended Practice - Adoption of IEC 61000-4-15:2010, Electromagnetic compatibility (EMC) - Testing and measurement techniques - Flickermeter - Functional and design specifications".

(l) Harmonics.

Harmonic distortion at the Point of Interconnection caused by the Facility shall not exceed the limits stated in IEEE Standard 519-1992, or latest version "Recommended Practices and Requirements for Harmonic Control in Electrical Power Systems". Seller shall be responsible for the installation of any necessary controls or hardware to limit the voltage and current harmonics generated from the Facility to defined levels.

(m) Frequency Response.

Seller Facility shall provide a primary frequency response with a frequency droop characteristic reacting to system frequency fluctuations at the Point of Interconnection in both the overfrequency and underfrequency directions except to the extent such response is not operationally possible because of the level of available **solar** resource.

- (i) The Facility frequency response control shall adjust, without intentional delay and without regard to the ramp rate limits in Section 3(c) (Ramp Rates) of this Attachment B (Facility Owned by Seller), the Facility's net real power export when system frequency is not 60 Hz based on frequency deadband and frequency droop settings specified by the Company.
- (ii) The Facility frequency response control shall be allowed to increase the net real power export above the Power Reference Limit set under Section 1(g)(viii) of this Attachment B (Facility Owned by Seller) or further decrease the net real power export from the Power Reference Limit in its operations.
- (iii) The frequency deadband shall be settable in the range from +/-0.01 Hz to +/- 0.10 Hz and the frequency droop shall be settable in the range of 0.1% to 10%.
- (iv) The Facility frequency response control shall be in continuous operation when the Facility is exporting energy to the Company unless directed otherwise by the Company.

(n) Inertia Constant.

Synchronous Generator(s) must have an inertia constant (H) between 4 to 6 seconds. **[TO BE REVIEWED BY COMPANY FOLLOWING THE IRS]**

4. Maintenance of Seller-Owned Interconnection Facilities.

- (a) Seller must address any Disconnection (as defined below) according to the requirements of this Section 4 (Maintenance of Seller-Owned Interconnection Facilities) of Attachment B (Facility Owned by Seller). For this purpose, a Disconnection is a disconnection from Company System of at least MW **[TO BE DETERMINED BY COMPANY FOLLOWING THE IRS]** from the Facility over a "rolling 120-second period", if such disconnection is due to a defect in or a failure of Seller-Owned Interconnection Facilities. A "rolling 120-second period" means a period that is comprised of 120 seconds and such rolling period will change as each new one (1) second elapses. With the elapse of each new one (1) second, the newest

one (1) second would be added to the 120-second period, and the oldest one (1) second would no longer be included in the rolling 120-second period.

- (b) For every disconnection from the Company System of at least [REDACTED] MW **[TO BE DETERMINED BY THE COMPANY UPON COMPLETION OF THE IRS]** from Facility over a rolling 120-second period ("Disconnection Event"), Seller shall investigate the cause of the Disconnection Event, and determine if it is a Disconnection as defined in Section 4(a) of this Attachment B (Facility Owned by Seller). Within three (3) Business Days of the Disconnection Event, Seller shall provide, in writing to Company, an incident report that summarizes the sequence of events and probable cause of the Disconnection Event, and states whether the Seller believes the Disconnection Event is a Disconnection.
- (c) Within forty-five (45) Days of a Disconnection, Seller shall provide, in writing to Company, Seller's findings, data relied upon for such findings, and proposed actions to prevent reoccurrence of a Disconnection ("Proposed Actions"). Company may assist Seller in determining the causes of and recommendations to remedy or prevent a Disconnection ("Company's Recommendations"). Seller shall implement such Proposed Actions (as modified to incorporate the Company's Recommendations, if any) and Company's Recommendations (if any) in accordance with the time period agreed to by the Parties.
- (d) In the event Seller and Company disagree as to (i) whether a Disconnection Event occurred, (ii) the sequence of events and/or probable cause of the Disconnection Event, (iii) whether the Disconnection Event is a Disconnection, (iv) the Proposed Actions, (v) Company's Recommendations, and/or (vi) the time period to implement the Proposed Actions and/or Company's Recommendations, then the Parties shall follow the procedure set forth in Section 5 (Expedited Dispute Resolution) of this Attachment B (Facility Owned by Seller).
- (e) Upon the fourth (4th) Disconnection (and each subsequent Disconnection) within any Contract Year, the Parties shall follow the procedures set forth in Section 4(a) and Section 4(d) of Attachment B (Facility Owned by Seller), to the extent applicable. If after following the procedures set forth in this Section 4 (Maintenance

of Seller-Owned Interconnection Facilities) of Attachment B (Facility Owned by Seller), Seller and Company continue to have a disagreement as to (1) the probable cause of the Disconnection, (2) the Proposed Actions, (3) the Company's Recommendations, and/or (4) the time period to implement the Proposed Actions and/or the Company's Recommendations, then the Parties shall commission a study to be performed by a qualified independent Third-Party consultant ("Qualified Consultant") chosen from the Qualified Independent Third-Party Consultants List ("Consultants List") attached to the Agreement as Attachment D (Consultants List). Such study shall review the design of, review the operating and maintenance procedures dealing with, recommend modifications to, and determine the type of maintenance that should be performed on Seller-Owned Interconnection Facilities ("Study"). Seller and Company shall each pay for one-half of the total cost of the Study. The Study shall be completed within ninety (90) Days from such fourth Disconnection (and each subsequent Disconnection) within any Contract Year, unless otherwise agreed to in writing by Seller and Company. The Qualified Consultant shall send the Study to Company and Seller. Seller (and/or its Third-Party consultants and contractors), at Seller's expense, shall change the design of, change the operating and maintenance procedures dealing with, implement modifications to, and/or perform the maintenance on Seller-Owned Interconnection Facilities recommended by the Study. Such design changes, operating and maintenance procedure changes, modifications, and/or maintenance shall be completed no later than forty-five (45) Days from the Day the completed Study is issued by the Qualified Consultant, unless otherwise agreed to in writing by Company. In the event the time requirement for the (i) commissioning of the Study, (ii) completion of the Study, or (iii) completion of the design change, operating and maintenance procedure change, modifications, and/or maintenance recommended by the Study is not achieved, Company may limit the total Allowed Capacity to a level that maintains reliable operations in accordance with Good Engineering and Operating Practices for the period that such requirement has not been achieved. Nothing in this provision shall affect Company's right to dispatch the Facility as provided for in this Agreement.

(f) The Consultants List attached hereto as Attachment D (Consultants List) contains the names of engineering firms which both Parties agree are fully qualified to perform the Study. At any time, except when a Study is being conducted, either Party may remove a particular consultant from the Consultants List by giving written notice of such removal to the other Party. However, neither Party may remove a name or names from the Consultants List without approval of the other Party if such removal would leave the list without any names. Intended deletions shall be effective upon receipt of notice by the other Party, provided that such deletions do not leave the Consultants List without any names. Proposed additions to the Consultants List shall automatically become effective thirty (30) Days after notice is received by the other Party unless written objection is made by such other Party within said thirty (30) Day period. By mutual agreement between the Parties, a new name or names may be added to the Consultants List at any time.

5. Expedited Dispute Resolution.

If there is a disagreement between Company and Seller regarding (i) Seller's compliance with the standards set forth in Section 3 (Performance Standards) of this Attachment B (Facility Owned by Seller), and/or (ii) Section 4 (Maintenance of Seller-Owned Interconnection Facilities) of this Attachment B (Facility Owned by Seller) such as (aa) whether a Disconnection Event occurred, (bb) the sequence of events and/or probable cause of the Disconnection Event, (cc) whether the Disconnection Event is a Disconnection, (dd) the Proposed Actions, (ee) the Company's Recommendations, and (ff) the time period to implement the Proposed Actions and/or the Company's Recommendations, then authorized representatives from Company and Seller, having full authority to settle the disagreement, shall meet in Hawai'i (or by telephone conference) and attempt in good faith to settle the disagreement. Unless otherwise agreed in writing by the Parties, the Parties shall devote no more than five (5) Business Days to settle the disagreement in good faith. In the event the Parties are unable to settle the disagreement after the expiration of the time period, then either Party may pursue the dispute resolution procedure set forth in Article 28 (Dispute Resolution) of this Agreement.

6. Modeling.

(a) Seller's Obligation to Provide Models. Within 30 Days of Company's written request, but no later than the Commercial Operations Date, Seller shall provide detailed data regarding the design and location of the Facility, in a form reasonably satisfactory to Company, to allow the modeling of the inverters and any other equipment within the Facility identified in the IRS which utilizes Source Code (such as energy storage system, STATCOM or DVAR equipment), including, but not limited to, integrated and validated power flow and transient stability models (such as PSS/E models), a short circuit model (such as an ASPEN model), and an electromagnetic transient model (such as a PSCAD model) of the inverters and any additional equipment identified in the IRS as set forth above, applied assumptions, and pertinent data sets (each a "Required Model" and collectively, the "Required Models"). Thereafter, during the Term, Seller shall provide working updates of any Required Model within 30 Days of (i) Company's written request, or (ii) Seller obtaining knowledge or notice that any Required Model has been modified, updated or superseded by the Source Code Owner.

(b) Escrow Establishment. If, pursuant to Section 6(a) (Seller's Obligation to Provide Models) of this Attachment B (Facility Owned by Seller), the Required Models are provided to the Company in a form other than Source Code, Seller shall arrange for and ensure that the Source Code for the relevant Required Model is deposited into the Source Code Escrow as set forth below in Section 6(b)(i) (Source Code Escrow) no later than the time periods set forth in Section 6(a) (Seller's Obligation to Provide Models) for delivery of the Required Models. Seller shall be responsible for all costs associated with establishing and maintaining the Source Code Escrow. If, however, Seller is unable to deposit the required Source Code into the Source Code Escrow within the time periods set forth in Section 6(a) (Seller's Obligation to Provide Models), Seller shall, no later than such time periods, instead establish a monetary escrow as set forth below in Section 6(b)(ii) (Monetary Escrow) of this Attachment B (Facility Owned by Seller).

(i) Source Code Escrow.

(A) Establishment of Source Code Escrow. If the Required Models are not provided to the Company in the form of Source Code pursuant to Section 6(a) of this Attachment B (Facility Owned by Seller), Seller shall: (a)

arrange for and ensure the deposit of a copy of the current version of the Source Code and relevant documentation for all Required Models with the Source Code Escrow Agent under the terms and conditions of the Source Code Escrow Agreement, and (b) arrange for and ensure the update of the deposited Source Code and relevant documentation for Major Releases and Minor Releases of the Required Models as soon as reasonably possible after they are made generally available.

(B) Release Conditions. Company shall have the right to obtain from the Source Code Escrow Agent one copy of the escrowed Source Code for the Required Models, under the following conditions upon Company's request:

(i) A receiver, trustee, or similar officer is appointed, pursuant to federal, state or applicable foreign law, for the Source Code Owner;

(ii) Any voluntary or involuntary petition or proceeding is instituted, under (x) U.S. bankruptcy laws or (y) any other bankruptcy, insolvency or similar proceeding outside of the United States, by or against the Source Code Owner; or

(iii) Failure of the Source Code Owner to function as a going concern or operate in the ordinary course; or

(iv) Seller and the Source Code Owner fail to provide to Company the Required Models or updated Required Models within the time periods set forth in Section 6(a) (Seller's Obligation to Provide Models) of this Attachment B (Facility Owned by Seller), Company gives written notice of such failure to Seller and the Source Code Owner, and Seller and Source Code Owner fail to remedy such breach within five (5) Days following receipt of such notice.

(C) Remedies. If Company has the right to obtain from the Source Code Escrow Agent one copy of the escrowed Source Code for the Required Models pursuant to Section 6(b)(i)(B) (Release Conditions) of Attachment B (Facility Owned by Seller), and Company finds that Seller failed to arrange for and ensure the update the Source Code Escrow with the modified and/or updated Source Code and relevant documentation for Major Releases and Minor Releases of the Required Models as provided in Section 6(b)(i) (Establishment of Source Code Escrow) of Attachment B (Facility Owned by Seller) or that the Source Code for the

Required Models is incomplete or otherwise unusable, Seller shall be liable to Company for liquidated damages in the amount of \$500 per day for each day Seller fails to provide such Source Code to Company or such update to the Source Code to Company from the date such Major Release or Minor Release was first made available by the Source Code Owner to customers of the Source Code Owner. Failure to provide the updated Source Code of the Required Models within 30 Days' notice from Company of a breach of Section 6(b)(i)(A) (Establishment of Source Code Escrow) of Attachment B (Facility Owned by Seller) shall constitute an Event of Default pursuant to Section 15.2(F) (Events of Default by a Party) under the Agreement.

(D) Certification. The Source Code Escrow Agent shall release the Source Code of the Required Models to Company upon receipt of a signed statement by a representative of Company that reads substantially as follows:

The undersigned hereby certifies that (i) I am duly authorized to execute this document on behalf of Hawaiian Electric Company, Inc. ("Hawaiian Electric"), and (ii) Hawaiian Electric is entitled to a copy of the Source Code of the Required Models Pursuant to Section 6(b)(i)(B) (Release Conditions) of Attachment B (Facility Owned by Seller) of the Power Purchase Agreement dated as of _____, between _____, and Hawaiian Electric.

(E) Authorized Use. If Company becomes entitled to a release of the Source Code of the Required Models from escrow, Company may thereafter correct, modify, update and enhance the Required Models for the sole purpose of providing itself the support and maintenance it otherwise would have been entitled to if it had been provided the Required Models by Seller under Section 6(a) (Seller's Obligation to Provide Models) of this Attachment B (Facility Owned By Seller) (the "Source Code Authorized Use").

(F) Confidentiality Obligations. Company shall keep the Source Code of the Required Models confidential pursuant to the confidentiality obligations of the Source Code Escrow Agreement. Company shall restrict access to the Source Code of the Required Models to those employees, independent contractors and consultants of Company

who have agreed in writing to be bound by confidentiality and use obligations consistent with those specified in the Escrow Agreement, and who have a need to access the Source Code of the Required Models on behalf of Company to carry out their duties for the Authorized Use. Promptly upon Seller's request, Company shall provide Seller with the names and contact information of all individuals who have accessed the Source Code of the Required Models, and shall take all reasonable actions required to recover any such Source Code in the event of loss or misappropriation, or to otherwise prevent their unauthorized disclosure or use.

(ii) Monetary Escrow.

(A) Establishment of Monetary Escrow. If the Required Models and their relevant Source Code are not provided to the Company in the form of Source Code pursuant to Section 6(a) (Seller's Obligation to Provide Models) of this Attachment B (Facility Owned by Seller) and if the Seller is unable to arrange for and ensure the deposit of the Source Code into the Source Code Escrow established for the benefit of the Company pursuant to Section 6(b)(i) (Source Code Escrow) of this Attachment B (Facility Owned by Seller) then, no later than the time periods set forth in Section 6(a) (Seller's Obligation to Provide Models) of this Attachment B (Facility Owned by Seller) for delivery of the Required Models and Source Code, Seller shall provide an irrevocable standby letter of credit with no documentation requirement in the amount of Two Hundred Fifty Thousand Dollars (\$250,000) per Required Model (and its relevant Source Code) substantially in the form attached to this Agreement as Attachment M (Form of Letter of Credit) from a bank or other financial institution located in the United States with a credit rating of "A-" or better . Such letter of credit shall be issued for a minimum term of one (1) year. Furthermore, at the end of each year the security shall be renewed for an additional one (1) year term so that at the time of such renewal, the remaining term of any such security shall not be less than one (1) year. The letter of credit shall include a provision for at least thirty (30) Days advance notice to Company of any expiration or earlier termination of the letter of credit so as to allow Company sufficient time to exercise its rights under said security if Seller fails to extend or replace the security. In all cases, the reasonable costs and expenses of establishing, renewing, substituting, canceling, increasing, reducing, or

otherwise administering the letter of credit shall be borne by Seller.

(B) Release Conditions. Company shall have the right to draw on the letter of credit the funds necessary to develop and recreate the Required Model or Required Models upon Company's request if Seller fails to provide the Company the Required Models or updated Required Models within the time periods set forth in Section 6(a) (Seller's Obligation to Provide Models) of this Attachment B (Facility Owned by Seller), Company gives written notice of such failure to Seller, and Seller fails to remedy such breach within five (5) days following receipt of such notice.

(C) Extend Letter of Credit. If the letter of credit is not renewed or extended no later than thirty (30) Days prior to its expiration or earlier termination, Company shall have the right to draw immediately upon the full amount of the letter of credit and to place the proceeds of such draw (the "Proceeds"), at Seller's cost, in an escrow account in accordance with Section 6(b)(ii)(D) (Proceeds Escrow), until and unless Seller provides a substitute form of letter of credit meeting the requirements of this Section 6(b)(ii) (Monetary Escrow) of this Attachment B (Facility Owned by Seller).

(D) Proceeds Escrow. If Company draws on the letter of credit pursuant to Section 6(b)(ii)(C) (Extend Letter of Credit) of this Attachment B (Facility Owned by Seller), Company shall, in order to avoid comingling the Proceeds, have the right but not the obligation to place the Proceeds in an escrow account as provided in this Section 6(b)(ii)(D) (Proceeds Escrow) of this Attachment B (Facility Owned by Seller) with a reputable escrow agent acceptable to Company ("Escrow Agent"). Without limitation to the generality of the foregoing, a federally-insured bank shall be deemed to be a "reputable escrow agent." Company shall have the right to apply the Proceeds as necessary to recover amounts Company is owed pursuant to this Section 6 (Modeling) of this Attachment B (Facility Owned by Seller). To that end, the documentation governing such escrow account shall be in form and content satisfactory to Company and shall give Company the sole authority to draw from the account. Seller shall not be a party to such documentation and shall have no rights to the Proceeds. Upon full satisfaction of Seller's obligations under Section 6 (Modeling) of this Attachment B (Facility Owned by Seller), Company shall instruct the Escrow

Agent to remit to the bank that issued the letter of credit that was the source of the Proceeds the remaining balance (if any) of the Proceeds. If there is more than one escrow account with Proceeds, Company may, in its sole discretion, draw on such accounts in any sequence Company may select. Any failure to draw upon the Proceeds for any damages or other amounts due Company shall not prejudice Company's rights to recover such damages or amounts in any other manner.

(E) Seller's Obligation. If the letter of credit is not sufficient to cover Company's associated consultant fees, costs and expenses to develop and recreate the Required Models, Seller shall pay to Company the difference within ten (10) Days of Company's written notice to Seller.

(F) Model Verification. Seller shall work with the Company to validate the new Required Models developed by or on behalf of Company within sixty (60) Days of receiving such new Required Models. Seller shall also arrange for and ensure that Company may obtain new Required Models directly from the Source Code Owner in the event that Seller ceases to operate as a going concern or is subject to voluntary or involuntary bankruptcy and is unable or unwilling to obtain the new Required Models from the Source Code Owner.

(G) Certification. The terms of the letter of credit shall provide for a release of the funds, or in the event the funds have been placed into a Proceeds Escrow, the Escrow Agent shall release the necessary funds to Company upon receipt of a signed statement by a representative of Company that reads substantially as follows:

The undersigned hereby certifies that (i) I am duly authorized to execute this document on behalf of Hawaiian Electric Company, Inc. ("Hawaiian Electric"), and (ii) Hawaiian Electric is entitled to \$ _____, pursuant to Section 6(b)(ii)(B) (Release Conditions) of Attachment B (Facility Owned by Seller) of the Power Purchase Agreement dated as of _____, between _____, and Hawaiian Electric.

(H) Authorized Use. If Company becomes entitled to a release of funds from escrow, Company may thereafter use such funds to develop, recreate, correct, modify, update and enhance the Required Models for the sole purpose of providing itself the support and maintenance it otherwise would have been entitled to if it had been provided the Required Models by Seller under Section 6(a) (Seller's Obligation to Provide Models) of this Attachment B (Facility Owned by Seller) (the "Monetary Authorized Use").

(iii) Supplementary Agreement. The parties stipulate and agree that the escrow provisions in this Attachment B (Facility Owned By Seller), Section 6(b) (Escrow Establishment) and the Source Code Escrow Agreement and Monetary Escrow Agreement are "supplementary agreements" as contemplated in Section 365(n)(1)(B) of the Code. In any voluntary or involuntary bankruptcy proceeding involving Seller, failure by Company to assert its rights to "retain its rights" to the intellectual property encompassed by the Source Code or the funds in the monetary escrow, pursuant to Section 365(n)(1)(B) of the Code, under an executory contract rejected in a bankruptcy proceeding, shall not be construed as an election to terminate the contract by Company under Section 365(n)(1)(A) of the Code.

7. Testing Requirements.

(a) Testing Requirements. Once the Control System Acceptance Test has been successfully passed, Seller shall not replace and/or change the configuration of the Facility Control, **inverter control settings** and/or ancillary device controls, without prior written notice to Company. In the event of any such replacement and/or change, the relevant test(s) of the Control System Acceptance Test shall be redone and must be successfully passed before the replacement or altered equipment is allowed to be placed in normal operations. In the event that Company reasonably determines that such replacement and/or change of controls makes it inadvisable for the Facility to continue in normal operations without a further Control Systems Acceptance Test, the Facility shall be deemed to be in Seller-Attributable Non-Generation status until the new relevant tests of the Control System Acceptance Test have been successfully passed.

(b) Periodic Testing. Seller shall coordinate periodic testing of the Facility with Company to ensure that the

Facility is meeting the performance standards specified under this Agreement.

8. Data and Forecasting.

Seller shall provide Site, meteorological and production data in accordance with the terms of Article 6 (Forecasting) of this Agreement and the following requirements:

(i) Physical Site Data: Seller shall provide Company with an accurate description of the physical Site, including but not limited to the following, which may not be changed during the Term without Company's prior written consent:

- A. Location Facility Map showing the layout of the Facility (coverage area or footprint) and the coordinates (latitude and longitude), elevation (above ground), orientation angle and direction (north-east-south-west plane) of arrays/concentrators.
- B. Location (latitude and longitude) and elevation (above ground) of each MMS and each field measurement device located on such MMS.
- C. Inverter type, power rating, array configuration to inverters and DC rating of the Facility at the following standard test conditions: irradiance of 1000 W/m², air mass 1.5, and cell temperature 25° C.
- D. Solar generation technology employed at the Facility with temperature dependence, mounting and module type.

(ii) Meteorological and Production Data:

- A. Seller shall install and maintain a minimum of one MMS for facilities with a Contract Capacity of less than 5 MW and a coverage area of not more than one square kilometer.
- B. Seller shall install and maintain a minimum of two MMS for facilities that have either (i) a DC rating of the Facility of 5 MW or greater or (ii) a coverage area greater than one square kilometer.

- C. Placement of each MMS should account for the microclimate of the area and Facility coverage area and shall be oriented with respect to the primary wind direction.
- D. For purposes of calculating the Measured Performance Ratio, the Seller shall provide (i) Plane of Array irradiance, (ii) back of panel temperature at array height, and (iii) the power production at the transducer on the Seller's side of the Point of Interconnection.
- E. Seller shall provide to Company, via SCADA communication and protocol acceptable to Company to support operations and forecasting needs at a continuous scan, all meteorological and production data required under this Agreement updated every 2 seconds.
- F. For facilities with a Contract Capacity greater than 1 MW, Seller shall arrange for a dedicated 12 kV line to provide separate service from Company, or for such other independent, backup power source as approved by Company in writing, to temporarily store and record the meteorological data from the field measuring devices at the MMSs. Any such backup power source must be capable of providing power for the field measurement devices for a reasonable period of time until primary power is restored. The same backup power source can serve multiple MMSs as needed by the Facility.

(iii) Units and Accuracy:

- A. The Table below shows minimum required solar irradiance measurements for various types of solar generation technology. **[DRAFTING NOTE:** This value may not be derived.

Solar Technology	Direct Normal Irradiance	Global Irradiance (GHI)	Plane of Array Irradiance (POA)
Flat Plate (fixed)		X	X

horizontal, fixed angle, tracking, roof mounted)			
Flat Panel Solar Thermal (fixed angle, roof mounted, tracking)	X		X
Concentrated PV (flat, trough, tracking)	X	X	X

- B. Units and accuracy of measured parameters to be provided to Company in real time shall be as shown in the Table below. These represent the minimum required accuracies.

Table of Units and Accuracy of Meteorological and Production Data (PV)

Parameter	Measurement Device (typical)	Unit	Range	Accuracy
Global Horizontal Irradiance at MMS	Pyranometer or equivalent	W/m ²	0 to 1500 W/m ²	Secondary standard per ISO 9060 or <= 3% from 100 W/m ² to 1500 W/m ² if using a PV Reference Cell
Plane of Array Irradiance on same axis as array	Pyranometer or equivalent	W/m ²	0 to 1500 W/m ²	Secondary standard per ISO 9060 or <= 3% from 100 W/m ² to 1500 W/m ² if using a PV Reference Cell
Back of Panel temperature at array height	Temperature probe	°C	-20 to +50 °C	+/-1 °C
Ambient air temperature at MMS	Temperature probe	°C	-20 to +50 °C	+/-1 °C
Ambient air pressure at MMS	Piezoresistive transducer or equivalent	mbar	150 to 1150 mbar	+/-60 mbar (0 to +50°C)
Wind speed at MMS	Anemometer, sonic device or equivalent	mph	0 to 134 mph	+/-1 mph
Wind direction at MMS	Vane, sonic device or equivalent	Degrees (from True North)	360°	+/-5°
Set point for each inverter	Reported by Seller	MW	0 to inverter name plate	Not applicable

Power production of Facility	Measured at Facility's analog transducer on Seller's side of POI	MW	Up to Allowed Capacity	The lesser of the tolerances of the /telemetry equipment or 2% of measurement
Facility power production ratio	Ratio of Facility's power production (MW)/Allowed Capacity (MW)	%	0 to 100%	+/-0.1 %
Inverters Available	NA	NA	Up to the number installed inverters	
Facility Inverter Availability	Ratio of inverters online/number of inverters	%	0 to 100%	
Power Possible	Seller's Model	MW	0 to Allowed Capacity	+/-4%

(iv) Status of Inverters for Purposes of Calculating Facility Availability:

For each inverter, Seller shall, unless agreed otherwise by Company and Seller in writing, provide to Company, via SCADA communication and protocol acceptable to Company at a continuous scan updated not less frequently than every 2 seconds, a signal as to whether such inverter is available or unavailable.

9. Technology Specific Requirements.

(a) Three-Phase Synchronous Generators.

The generating facility circuit breakers shall be 3-phase devices with electronic or electromechanical control. The Seller shall be responsible for properly synchronizing its generating facility with the Company System by means of either a manual or automatic synchronizing function. Automatic synchronizing is required for all synchronous generators which have an short circuit current rating ("SCCR") greater than 5%.

For a generating facility whose SCCR exceeds 5%, the Facility shall provide protective equipment suitable for detecting loss of synchronism and automatically disconnecting the generating facility from the Company System. Unless otherwise agreed to between the Company and Seller, synchronous generators shall automatically regulate power factor, not voltage, while operating in parallel with the Company System.

(b) Induction Generators.

- (i) Induction generators may be connected and brought up to synchronous speed (as an induction motor) if it can be demonstrated that the initial voltage drop measured at the Point of Interconnection is within the visible flicker limits as defined by IEEE 519-1992 (or latest version). The same requirements also apply to induction generation connected at or near synchronous speed because a similar voltage dip is present due to an inrush magnetizing current. The Facility shall submit number of starts per specific time period and maximum starting kVA draw data for the utility to verify that the voltage dip due to starting is within the visible flicker limits and does not degrade the normal voltage provided by the utility.
- (ii) Induction generators do not require separate synchronizing equipment. Starting or rapid load fluctuations on induction generators can adversely impact the Company System voltage. Corrective step-switched capacitors or other techniques may be necessary if the voltage fluctuations measured at the Point of Interconnection are not within the visible flicker limits as defined by IEEE 519-1992 (or latest version). These measures can, in turn, cause ferroresonance. If these measures (additional capacitors) are installed on Seller's side of the Point of Interconnection, the Company will review these measures and may require Seller to install additional protective relaying equipment. Company will determine whether additional equipment is required to protect the Company System.

(c) Inverter Systems.

- (i) Direct current generators and non-power (i.e. other than 60 Hertz) alternating current generators can only be installed in parallel with the Company System using a non-islanding synchronous inverter. The design shall comply with the requirements of IEEE Std 1547-2003 (or latest version), except as described in Section 3 (Performance Standards) of this Attachment B (Facility Owned by Seller).
- (ii) Self-commutated inverters of the Company-interactive type shall synchronize to the Company System. Line-commutated, thyristor-based inverters are not recommended and will require additional technical study to determine harmonic and reactive power requirements. All interconnected inverter systems shall comply with the harmonic current limits of IEEE Std 519-1992 (or latest version).

EXHIBIT B-1
REQUIRED MODELS

PSS/E

ASPEN

PSCAD

EXHIBIT B-2
GENERATOR CAPABILITY CURVE(S)

**[ATTACHMENT C WILL BE REVISED TO REFLECT
THE RESULTS OF IRS]**

ATTACHMENT C
METHODS AND FORMULAS FOR MEASURING PERFORMANCE STANDARDS

1. Performance Standards as defined below shall be used, in part, to govern actions by Company to limit the Actual Output of the Facility for purposes of maintaining power quality on Company System. Specific standards are defined for:

- Ramp Rate (RR)

2. Formulas for measuring the performance standards are presented below, and assume that the power fluctuations will be monitored on the Company's SCADA and EMS systems. These formulas are based on the periodicity at which analog data is retrieved from the RTU. This periodicity is called the "scan rate". Company presently uses a two-second analog scan rate. The formulas below are based on the two-second scans. The two-second scan rate, characteristics of transducers and RTU reporting, and SCADA method of calculation, were considered and included in the proposed values for the performance standards.

3. Ramp Rate Calculation:

$$RR = MW_s - MW_{s-30}$$

Where:

RR = Ramp Rate, may be calculated once every scan

MW_{s-30} = The instantaneous MW analog value 30 scans (60 seconds) prior the present scan

MW_s = The instantaneous MW analog value for the present scan

ATTACHMENT D
CONSULTANTS LIST

ATTACHMENT E
SINGLE-LINE DRAWING AND INTERFACE BLOCK DIAGRAM

(To be attached as per Section 1(a) of Attachment B)

ATTACHMENT F
RELAY LIST AND TRIP SCHEME

(To be attached as per Section 1(a) of Attachment B.)

**[ATTACHMENT G SHALL BE REVISED TO REFLECT
THE RESULTS OF IRS]**

ATTACHMENT G
COMPANY-OWNED INTERCONNECTION FACILITIES

1. Description of Company-Owned Interconnection Facilities.

- (a) General. Company shall furnish or construct (or may have Seller furnish or construct, in whole or in part), own, operate and maintain all Interconnection Facilities required to interconnect Company System with Facility at [REDACTED] volts, up to the Point of Interconnection (collectively, the "Company-Owned Interconnection Facilities").
- (b) Site. Where any Company-Owned Interconnection Facilities are to be located on the Site, Seller shall provide, at no expense to Company, a location and access acceptable to Company for all such Company-Owned Interconnection Facilities, as well as an easement, license or right of entry to access such Company-Owned Interconnection Facilities. If power sources (120/240VAC) are required, Seller shall provide such sources, at no expense to Company.
- (c) IRS. An IRS addressing Facility requirements was completed for the Project in accordance with the IRS Letter Agreement, and the results have been incorporated in Attachment B (Facility Owned by Seller) and this Attachment G (Company-Owned Interconnection Facilities) as appropriate.
- (d) Seller's Payment Obligations. Company-Owned Interconnection Facilities, for which Seller has agreed to pay, whether designed, engineered and constructed by Seller or Company, include **[ADD LIST OF COMPANY-OWNED INTERCONNECTION FACILITIES THAT ARE REQUIRED PURSUANT TO THE RESULTS OF THE IRS. THE FOLLOWING IS AN EXAMPLE OF THE TYPES OF FACILITIES THAT COULD BE LISTED]:**
- (i) **[Line extension];**
- (ii) A manually operated, lockable, group operated switch located on a pole prior to the Facility

- switching station. Company will install a ___ kV drop into Seller-provided deadend structure.
- (iii) Substation additions and/or modifications of Company's existing structures as necessary. This would include but not be limited to protective relaying and setting changes;
 - (iv) Supervisory control and communications equipment (including but not limited to, SCADA/RTU, microwave, satellite, dedicated phone line(s) and/or any other acceptable communications means (determined by Company), fiber optics, copper cabling, installation of batteries and charger system, etc.);
 - (v) Revenue Metering Package as provided in Section 10.1 (Meters of the Agreement);
 - (vi) Any additional Interconnection Facilities needed to be installed as a result of final determination of Facility switching station site, final design of Facility to enable Company to complete the Interconnection Facilities and be compatible with Good Engineering and Operating Practices.
 - (vii) If equipment that is not standard to Company is utilized, Seller shall, at the discretion of Company, provide adequate spares.
- (e) Revisions to Costs. The list of Company-Owned Interconnection Facilities, and engineering and testing costs for Company-Owned Interconnection Facilities, for which Seller agrees to pay in accordance with this Attachment G (Company-Owned Interconnection Facilities), are subject to revision if (i) before approving this Agreement, the PUC approves a power purchase agreement for another non-Company owned electric generating facility ("Second NUG Contract") to supply electric energy to Company using the same line to which Facility is to be connected or (ii) the line to which Facility is to be connected and/or the related transformer(s) need(s) to be upgraded and/or replaced as a result of this Agreement and a Second NUG Contract, and the PUC, in approving this Agreement, determines that Seller should pay for all or part of the cost of such upgrade and/or replacement.

(f) Review of the Listing and Costs. If the Commercial Operations Date is not achieved within twelve (12) months of the Effective Date or thirty (30) months from the Execution Date, whichever is less, the listing of the Company-Owned Interconnection Facilities required in this Agreement and the cost-estimates for such Company-Owned Interconnection Facilities are subject to review and revision. Such revision may include, but not be limited to, such items as reconductoring an existing transmission or distribution line, construction of a new line, increase transformer capacity, and alternative relay specifications. In addition, such review and revision may require that the Company re-perform or update the IRS at the Seller's expense.

(g) Responsibility of Seller and Company. The general responsibilities of Seller and Company for the design, procurement, installation, programming/testing, and maintenance/ownership of equipment at the Facility and the Company-Owned Interconnection Facilities is specified in Matrix G-1 (Substation Responsibilities) and Matrix G-2 (Telecom Responsibilities). **[DRAFTING NOTE: MATRIXES WILL BE UPDATED FOLLOWING COMPLETION OF IRS.]**

[DRAFTING NOTE: THE TYPICAL TIMEFRAMES ON O'AHU FOR COMPANY TO ENGINEER, PROCURE AND CONSTRUCT THE COMPANY-OWNED INTERCONNECTION FACILITIES, FOLLOWING THE COMPLETION OF: 1) THE IRS; 2) SELLER'S SINGLE LINE FOLLOWS:

(i) 36 MONTHS FOR 138 kV FACILITIES.

(ii) 30 MONTHS FOR 46 kV FACILITIES WITH MINOR INFRASTRUCTURE IMPROVEMENTS.] [DRAFTING NOTE: FOR OTHER ISLANDS.]

2. Construction and Support Services By Seller.

(a) Construction and Support Services By Seller.

(i) Seller (and/or its Third Party consultants or contractors (collectively, "Contractors")) will design, engineer, construct, test and place in service, at Seller's expense:

- A. The items identified in Matrix G-1 (Substation Responsibilities) and Matrix G-2 (Telecom Responsibilities) as being the responsibility of Seller to construct; and
- B. **[ANY OTHER COMPANY-OWNED INTERCONNECTION FACILITIES TO BE CONSTRUCTED BY SELLER].
[NOTE: SUBPARTS "A" AND "B" BETWEEN THEM SHOULD GENERALLY INCLUDE A SUBSET OF THE LIST IN SECTION 1(d) ABOVE]**

All design, engineering and construction performed by Seller (and/or its Contractors) shall, without limitation, satisfy the wind load and seismic load requirements of the International Building Code and any more stringent requirements imposed under applicable Laws.

- (ii) Seller shall provide the necessary support for the Company's [REDACTED] kV overhead line extension work, which may include, but not limited to:
 - A. Furnish surveyed topographical drawing including contour lines of project areas and beyond as needed in State Plane coordinates with overlay of the Facility and Company pole line route(s) indicating pole locations and anchors in CADD format acceptable to Company.
 - B. Staking of Company proposed poles and anchors by surveyor.
 - C. Graded access roads including gravel if required by Company to provide sufficient vehicle access to Company poles and anchors by Company trucks and cranes.
 - D. Graded level pads to provide vehicle working areas around all Company poles and anchors.
 - E. Grading of the areas beneath the Company's overhead lines as needed to provide required ground clearance.
 - F. Grubbing and clearing of vegetation within Company's easement area or as required.

- (b) Coordination of Construction. Prior to Seller engaging the Contractors, Seller shall obtain Company's written

approval, which approval shall not be unreasonably withheld. Prior to Seller and/or its Contractors first starting to work on the construction plans for Company-Owned Interconnection Facilities to be constructed by Seller (and/or its Contractors), such as the civil, structural, and construction drawings, specifications to vendors, vendor approved final drawings and materials lists (collectively, the "Plans"), Seller and/or its Contractors shall meet with Company to discuss the construction of such Company-Owned Interconnection Facilities, including but not limited to subjects concerning coordination of construction milestone dates, agreement on areas of interface design, and Company's design/drawing layout and symbols standards, equipment specifications and construction specifications and standards. Company will provide the design and specifications information so Seller can incorporate such information in its bid documents.

- (c) Plans. No later than sixty (60) Days before Seller and/or its Contractors first start to order materials and equipment for Company-Owned Interconnection Facilities to be constructed by Seller and/or its Contractors, Seller shall provide Company with the Plans. The Plans for Company-Owned Interconnection Facilities to be constructed by Seller (and/or its Contractors) shall comply with (i) all applicable Laws; (ii) Company's design/drawing layout and symbol standards, equipment specifications, and construction specifications and standards; and (iii) Good Engineering and Operating Practices (collectively, the "Standards").
- (d) Company's Review of the Plans. Unless otherwise agreed to by the Parties, Company shall have thirty (30) Days following receipt of the Plans for it to review and comment on the Plans, and verify in writing to Seller that the Plans comply with the Standards, which verification shall not be unreasonably withheld. If Company reasonably determines that the Plans are not in accordance with the Standards, then it may request in writing a response from Seller to its comments and Seller shall respond in writing within thirty (30) Days of such request by providing (i) its justification for why its Plans conform to the Standards or (ii) changes in the Plans responsive to Company's comments and in accordance with the Standards.

- (e) Company Inspection. Construction work will be subject to Company inspections to ensure that construction is done in accordance with the Standards. Company inspectors will be allowed access to the construction sites for inspections and to monitor construction work. The inspector shall have the authority to work with the appropriate construction supervisor to stop any work that does not meet the Standards. All equipment and materials used in Company-Owned Interconnection Facilities to be constructed by Seller and/or its Contractors shall meet the Standards.
- (f) Acceptance Test Procedures.
- (i) The following conditions precedent must be satisfied prior to the conduct of the Acceptance Test:
- Final Single-Line Drawing, and notes, has received Company's written consent pursuant to Section 1(a)(i) (Single Line Drawing, Interface Block Diagram, Relay List, Relay Settings and Trip Scheme) of Attachment B (Facility Owned by Seller) to this Agreement.
 - Final Relay List and Trip Scheme have received Company's written consent pursuant to Section 1(a)(i) of Attachment B (Facility Owned by Seller) to this Agreement.
 - Final Interface Block Diagram has received Company consent pursuant to Section 1(a)(i) of Attachment B (Facility Owned by Seller) to this Agreement.
 - Final Control **System RTU** Points List has received Company consent. **[DRAFTING NOTE FOR HELCO, REPLACE HIGHLIGHTED TEXT WITH "Telemetry and Control."]**
 - Final **digital fault recorder settings** have received Company consent. **[DRAFTING NOTE FOR HELCO, REPLACE HIGHLIGHTED TEXT WITH "phasor measurement unit (PMU) devices."]**
 - No later than 14 Days prior to commencement of the Acceptance Test:
 - Seller shall have certified to Company that Seller-Owned Interconnection

Facilities have been installed and commissioned and such certification has not, prior to the commencement of the Acceptance Test, been subsequently challenged by Company on the basis of on-site observations made by the Company's representatives following the walk-through to be conducted pursuant to Section 2(f)(ii) of this Attachment G (Company-Owned Interconnection Facilities).

- Seller shall have certified to Company that any Company-Owned Interconnection Facilities built by Seller (and/or its Contractors) have been installed and commissioned and such certification has not, prior to the commencement of the Acceptance Test, been subsequently challenged by Company on the basis of on-site observations made by the Company's representatives following the walk-through to be conducted pursuant to Section 2(f)(ii) of this Attachment G (Company-Owned Interconnection Facilities).
- Any Company-Owned Interconnection Facilities not built by or on behalf of Seller have been installed and commissioned.
- No later than 7 Days prior to the commencement of the Acceptance Test, Seller and Company shall have participated in walk-through of fully constructed Interconnection Facilities.
- Redlined as-built drawings of the Seller-Owned Interconnection Facilities and any of the Company-Owned Interconnection Facilities built by Seller (and/or its Contractors) shall have been provided to Company.
- Continuous power is being supplied to Company's protection and SCADA equipment.
- Not less than four (4) weeks prior to the commencement of the Acceptance Test, the high speed communication lines required under this Agreement have been commissioned and are ready for use.

- Not less than two (2) weeks prior to the commencement of the Acceptance Test, Seller and Company have participated in an on-Site Acceptance Test coordination meeting.
- (ii) Seller shall provide Company with at least fourteen (14) Days advance written notice of the commencement of the Acceptance Test. The Acceptance Test will be conducted on Business Days during normal business hours and may take a minimum of 30 Days to complete. No electric energy will be delivered from Seller to Company during the Acceptance Test. No later than thirty (30) Days prior to conducting the Acceptance Test, Company and Seller shall agree on a written protocol setting out the detailed procedure and criteria for passing the Acceptance Test. Attachment N (Acceptance Test General Criteria) provides general criteria to be included in the written protocol for the Acceptance Test. At the time that Seller provides its 14-Day notice of the Acceptance Test to Company, Seller shall concurrently schedule a site walk-through of the Facility with Company to occur no later than seven (7) Days prior to the Acceptance Test. Seller's 14-Day notice to Company of the Acceptance Test shall constitute its certification that (i) the completion of the installation and commissioning of the Seller-Owned Interconnection Facilities and the Company-Owned Interconnection Facilities built by Seller (and/or its Contractors) and (ii) a walk-through by Company shall demonstrate, to Company's reasonable satisfaction, Seller's readiness to commence with the Acceptance Test. If, after the site walk-through, Company representatives reasonably determine that Seller is not ready to commence with the Acceptance Test, Seller shall remediate the deficiencies identified by Company and, upon completion, re-submit its 14-Day written notice of the Acceptance Test, and the process described in this Section 1(f) (Acceptance Test Procedures), shall commence again until Seller's readiness for the Acceptance Test is demonstrated to Company's reasonable satisfaction. Successful completion of the Acceptance Test requires successful completion of

each of the individual tests that comprise the Acceptance Test. Retesting of any individual test constitutes as restart of the Acceptance Test if such retesting is required because of a prior failure of such individual test or because of a prior test could not be completed because of a problem with the Facility. Within fifteen (15) Business Days of completion of the Acceptance Test and Company's receipt of the final report setting forth the results of the Acceptance Test, Company shall notify Seller in writing whether the Acceptance Test has been passed and, if so, the date upon which the Acceptance Test was passed.

(iii) Company will be present when the Acceptance Test is conducted, and Seller shall promptly correct any deficiencies identified during the Acceptance Test. Seller will be responsible for the cost of Company personnel (and/or Company contractors) performing the duties (such as reviewing the Plans and reviewing the construction) necessary for Company-Owned Interconnection Facilities to be constructed by Seller (and/or its Contractors). If Company (i) does not make any inspection or test, (ii) does not discover defective workmanship, materials or equipment, or (iii) accepts Company-Owned Interconnection Facilities (that were constructed by Seller and or its Contractors), such action or inaction shall not relieve Seller from its obligation to do and complete the work in accordance with the Plans approved by Company.

(g) As-Built Drawings. Within thirty (30) Days of the successful completion of the Acceptance Test, Seller shall provide for Company review a set of the proposed as-built drawings for the Company-Owned Interconnection Facilities constructed by Seller (and/or its Contractors). Within thirty (30) Days of Company's receipt of the proposed as-built drawings, Company shall provide Seller with either (i) its comments on the proposed as-built drawings or (ii) notice of acceptance of the proposed as-built drawings as final as-built drawings. If Company provides comments on the proposed as-built drawings, Seller shall incorporate such comments into a final set of as-built drawings and provide such

final as-built drawings to Company within twenty (20) Days of Seller's receipt of Company's comments.

3. Seller Payment To Company for Company-Owned Interconnection Facilities and Review Of Facility.

(a) Seller Payment to Company.

(i) Seller shall pay the Total Estimated Interconnection Cost which is comprised of the estimated costs of (aa) acquiring, constructing and installing the Company-Owned Interconnection Facilities to be designed, engineered and constructed by Company, (bb) the engineering and design work (including but not limited to Company, affiliated Company and contracted engineering and design work) associated with (i) the application process for the PUC Approval Order, (ii) developing such Company-Owned Interconnection Facilities and (iii) reviewing and specifying those portions of Facility which allow interconnected operations as such are described in Attachment B(Facility Owned by Seller) (collectively, the "Engineering and Design Work"), and (cc) conducting the Acceptance Test and Control System Acceptance Test. The Total Actual Interconnection Cost (the actual cost of items (aa) through (cc)) are the "Total Interconnection Cost".

(ii) Summary List of Company-Owned Interconnection Facilities and Related Services to be designed, engineered and constructed by Company:

[THIS LIST SHOULD GENERALLY INCORPORATE A SUBSET OF THE LIST IN ATTACHMENT G, SECTION 1(d), PLUS TESTING.]

(i) The following summarizes the Total Estimated Interconnection Cost of the Company-Owned Interconnection Facilities to be designed, engineered and constructed by Company:

[THIS LIST SHOULD INCLUDE ESTIMATED COSTS FOR THE ITEMS LISTED IN ATTACHMENT G, SECTION 3(a)(ii).]

The Total Estimated Interconnection Cost is \$.

- (b) Total Estimated Interconnection Costs. The Total Estimated Interconnection Cost, which, except as otherwise provided herein, is non-refundable, shall be paid in accordance with the following schedule:
- (i) Initial Payment: Prior to the Execution Date, Seller has paid \$ [REDACTED],000.00 to Company;
 - (ii) Company-Owned Interconnection Facilities Prepayment: Thirty (30) Days after the Execution Date, the total estimated costs related to the Engineering and Design Work are due and payable by Seller to Company;
 - A. Company shall not be obligated to perform any Engineering and Design Work or procure and construct Company-Owned Interconnection Facilities until Seller pays the amounts in Section 3(b)(i) and Section 3(b)(ii) of this Attachment G (Company-Owned Interconnection Facilities), and receipt of such payment shall constitute Seller's irrevocable authorization to Company to perform such engineering and design work.
 - (iii) Balance of Company-owned Interconnection Facilities Prepayment: Upon the earlier of (aa) 30 Days after the Effective Date or (bb) [**INSERT CALENDAR DATE BY WHICH EQUIPMENT MUST BE ORDERED TO MEET CONSTRUCTION SCHEDULE**], the difference between the portion of the Total Estimated Interconnection Cost paid to date and the Total Estimated Interconnection Cost is due and payable by Seller to Company.
 - A. Company shall not be obligated to perform any Engineering and Design Work or procure and construct Company-Owned Interconnection Facilities until Seller pays the amount in this Section 3(b)(iii) of this Attachment G (Company-Owned Interconnection Facilities), and receipt of such payment shall constitute Seller's irrevocable authorization to Company to perform such procurement and construction work.
- (c) True-Up. The final accounting shall take place within one hundred twenty (120) Days of the first to occur of

(i) the Commercial Operations Date, (ii) the date this Agreement is declared null and void under either Section 12.5 (Prior to Effective Date) or Section 12.6 (Time Periods for PUC Submittal Date and PUC Approval), or (iii) the date this Agreement is terminated, whichever occurs first. Company shall be entitled to an extension for a commercially reasonable amount of time to complete the final accounting if a delay in such completion is caused by Seller's delay or failure to respond to any Company request for information needed to complete the final accounting or take any action necessary for Company to complete the final accounting. Upon completion of the final accounting, Company shall deliver to Seller an invoice for payment of the amount, if any, of the difference between the Total Estimated Interconnection Cost paid to date and the Total Actual Interconnection Cost, which is the final accounting of the Total Interconnection Costs. Payment of such invoice shall be made within thirty (30) Days of receipt of such invoice from Company. If the Total Actual Interconnection Cost is less than the payments received by Company as the Total Estimated Interconnection Cost, Company shall repay the difference to Seller within thirty (30) Days of the final accounting.

(d) Audit Rights. Seller shall have the right for a period of one (1) year following receipt of the invoice: (i) upon reasonable prior notice, to audit the books and records of Company to the limited extent reasonably necessary to verify the basis for the amount (if any) by which the Total Actual Interconnection Cost invoiced to Seller exceeds the Total Estimated Interconnection Cost, and (ii) to dispute the amount of any such excess. Seller shall not have the right to audit any other financial records of Company. Company shall make such information available during normal business hours at its offices in Hawai'i. Seller shall pay Company's reasonable actual, verifiable costs for such audits, including allocated overhead.

(e) Ownership. All Company-Owned Interconnection Facilities including those portions, if any, provided, or provided and constructed, by Seller shall be the property of Company.

4. Ongoing Operation and Maintenance Charges.

- (a) Prior to the Transfer Date. Seller shall operate and maintain, at its sole cost and expense, Company-Owned Interconnection Facilities that it or its Contractors constructed, if any, prior to the Transfer Date.
 - (b) On or After the Transfer Date. On and after the Transfer Date, Company shall own, operate and maintain Company-Owned Interconnection Facilities.
 - (c) Monthly Bill. Company shall bill Seller monthly for any costs incurred in operating, maintaining and replacing (to the extent not covered by insurance) Company-Owned Interconnection Facilities. Company's costs will be determined on the basis of, but not limited to, direct payroll, material costs, applicable overhead at the time incurred, consulting fees and applicable taxes. Seller shall, within thirty (30) Days after the billing date, reimburse Company for such monthly billed operation and maintenance charges.
5. Relocation of Company-Owned Interconnection Facilities.
- (a) In the event that the Land Rights include a relocation clause and such clause is exercised or if Company-Owned Interconnection Facilities must be relocated for any other reason not caused by Company, Seller shall bear the cost of such relocation. Prior to the relocation of the Company-Owned Interconnection Facilities Company shall invoice Seller for the total estimated cost of relocating the Company-Owned Interconnection Facilities (the "Total Estimated Relocation Cost"). Seller shall, within thirty (30) Days after the invoice date, pay to Company the Total Estimated Relocation Cost.
 - (b) Once the relocation of the Company-Owned Interconnection Facilities is complete, Company shall conduct a final accounting of all costs related thereto. Within thirty (30) Days of the final accounting, which shall take place within one hundred and twenty (120) Days of completion of the relocation of Company-Owned Interconnection Facilities, Seller shall remit to Company the difference between the Estimated Relocation Cost paid to date and the total actual relocation cost incurred by Company (the "Total Actual Relocation Cost"). If the Total Actual Relocation Cost is less than the payments received by Company as the Total Estimated Relocation Cost, Company shall repay the

difference to Seller within thirty (30) Days of the final accounting.

6. Guarantee for Interconnection Costs.

- (a) Standby Letter of Credit. To ensure payment by Seller of all costs and expenses incurred by Company (i) in excess of the Total Estimated Interconnection Cost paid in connection with the Company-Owned Interconnection Facilities to be provided and/or constructed by Company described in Section 3 (Seller Payment to Company for Company-Owned Interconnection Facilities and Review of Facility) of this Attachment G (Company-Owned Interconnection Facilities), and (ii) if applicable, in excess of the Total Estimated Relocation Costs paid in connection with the relocation of the Company-Owned Interconnection Facilities as provided in Section 5 (Relocation of Company-Owned Interconnection Facilities), Seller shall obtain an Irrevocable Standby Letter of Credit with no Documentary Requirement ("Standby Letter of Credit") in accordance with the requirements of Section 6(b) (Requirements of the Standby Letter of Credit) of this Attachment G (Company-Owned Interconnection Facilities), wherein Company shall receive payment from the bank upon request by Company.
- (b) Requirements of the Standby Letter of Credit. The Standby Letter of Credit shall be (i) in an amount not less than twenty-five percent (25%) of the Total Estimated Interconnection Cost or Total Estimated Relocation Cost, as applicable, and (ii) in substantially in the form attached to this Agreement as Attachment M (Form of Letter of Credit) from a bank or other financial institution located in the United States with a credit rating of "A-" or better. If the rating (as measured by Standard & Poors) of the bank or financial institution issuing the Standby Letter of Credit falls below A-, Company may require Seller to replace the Standby Letter of Credit with a Standby Letter of Credit from another bank or financial institution located in the United States with a credit rating of "A-" or better. In connection with the construction of the Company-Owned Interconnection Facilities, the Standby Letter of Credit shall be effective from the earlier of (aa) thirty (30) Days following the Effective Date, or (bb) the date that Seller requests Company to order equipment or commence

construction on Company-Owned Interconnection Facilities. In connection with the relocation of the Company-Owned Interconnection Facilities, if applicable, the Standby Letter of Credit shall be effective within thirty (30) Days after Seller receives the invoice from Company for the Total Estimated Relocation Cost as set forth in Section 5 (Relocation of Company-Owned Interconnection Facilities) of this Attachment G (Company-Owned Interconnection Facilities). The Standby Letter of Credit shall be in effect through the earlier of forty-five (45) Days after the final accounting or seventy-five (75) Days after the Agreement is terminated. Seller shall provide to Company within fourteen (14) Days of the date the Standby Letter of Credit is to be effective as aforesaid, a document from the bank which indicates that such a Standby Letter of Credit has been established.

- (c) Other Form of Security. Notwithstanding the foregoing, in lieu of a Standby Letter of Credit, Company may, at its sole discretion, agree in writing to accept such other form of security as Company deems to provide Company with protection equivalent to a Standby Letter of Credit.

7. Land Restoration.

- (a) Definition of "Land". For the purposes of this Attachment G (Company-Owned Interconnection Facilities), "Land" means any portion of the Site and any other real property where any Company-Owned Interconnection Facilities are located.
- (b) Removal of Interconnection Facilities. After termination of this Agreement or in the event this Agreement is declared null and void under either Section 12.5 (Prior to Effective Date) or Section 12.6 (Time Periods for PUC Submittal Date and PUC Approval), if requested by Company, Seller shall, at its sole cost and expense, remove (i) the Company-Owned Interconnection Facilities from the Land and (ii) the Seller-Owned Interconnection Facilities from the Land, and, in conjunction with such removal, shall develop and implement a program to recycle, to the fullest extent possible, or to otherwise properly dispose of, all such removed infrastructure; provided, however, that, Company may elect to remove all or part of the Company-Owned Interconnection Facilities

and/or Seller-Owned Interconnection Facilities from the Land because of operational concerns over the removal of such Interconnection Facilities, in which case Seller shall reimburse Company for its costs to remove such Company-Owned Interconnection Facilities and/or Seller-Owned Interconnection Facilities. To the extent Seller is obligated to remove Company-Owned Interconnection Facilities and/or Seller-Owned Interconnection Facilities, Seller shall complete such removal within ninety (90) Days of termination of this Agreement (or declaration that the Agreement is null and void under either Section 12.5 (Prior to Effective Date) or Section 12.6 (Time Periods for PUC Submittal Date and PUC Approval), or as otherwise agreed to by both Parties in writing.

- (c) Restoration of the Land. After the termination of this Agreement (or declaration that the Agreement is null and void under either Section 12.5 (Prior to Effective Date) or Section 12.6 (Time Periods for PUC Submittal Date and PUC Approval)) and removal of the Company-Owned Interconnection Facilities and/or Seller-Owned Interconnection Facilities, as the case may be, Seller shall, at its sole cost and expense, restore the Land to its condition prior to construction of such Company-Owned Interconnection Facilities and/or Seller-Owned Interconnection Facilities, as applicable. Land restoration shall be completed within ninety (90) Days of termination of this Agreement (or declaration that the Agreement is null and void under either Section 12.5 (Prior to Effective Date) or Section 12.6 (Time Periods for PUC Submittal Date and PUC Approval)), or as otherwise agreed to by both Parties in writing.

8. Transfer of Ownership/Title.

- (a) Transfer of Ownership and Title. On the Transfer Date, Seller shall transfer to Company all right, title and interest in and to Company-Owned Interconnection Facilities to the extent such facilities were designed and constructed by Seller and/or its Contractors together with (i) all applicable manufacturers' or Contractors' warranties which are assignable and (ii) all Land Rights necessary to operate and maintain Company-Owned Interconnection Facilities on and after the Transfer Date. Seller shall provide a written list of the manufacturers' and Contractors' warranties which

will be assigned to Company and the expiration dates of such warranties no later than thirty (30) Days before the Transfer Date.

- (b) No Liens or Encumbrances. Company's title to and ownership of Company-Owned Interconnection Facilities that were designed and constructed by Seller and/or its Contractors shall be free and clear of liens and encumbrances.
 - (c) Form of Documents. The transfers to be made to Company pursuant to this Section 8 (Transfer of Ownership/Title) of Attachment G (Company-Owned Interconnection Facilities) shall not require any further payment by Company. The form of the document to be used to convey title to the Company-Owned Interconnection Facilities that were designed and constructed by or on behalf of Seller shall be substantially in the form set forth in Attachment H (Form of Bill of Sale and Assignment). The form of the document(s) to be used to assign leases shall be substantially in the form set forth in Attachment I (Form of Assignment of Lease and Assumption). To the extent Land Rights other than leases are transferred to Company, appropriate modifications will be made to Attachment I (Form of Assignment of Lease and Assumption) to effectuate the transfer of such Land Rights.
9. Governmental Approvals for Any Company-Owned Interconnection Facilities Constructed by Seller.

Seller shall obtain at its sole cost and expense all Governmental Approvals necessary to the construction, ownership, operation and maintenance of the Company-Owned Interconnection Facilities. For Company-Owned Interconnection Facilities to be constructed by Company, Seller shall provide all Governmental Approvals necessary to the construction of such Company-Owned Interconnection Facilities prior to the commencement of construction by Company. For all other Governmental Approvals for Company-Owned Interconnection Facilities, Seller shall provide these prior to the Transfer Date. On or before the Transfer Date, Seller shall provide Company with (i) copies of all such Governmental Approvals obtained by Seller regarding the construction, ownership, operation and maintenance of Company-Owned Interconnection Facilities that Seller and/or its Contractors constructed and (ii) documentation regarding

the satisfaction of any condition or requirement set forth in any Governmental Approvals for Company-Owned Interconnection Facilities or that such Governmental Approvals have otherwise have been closed with the issuing Governmental Authority.

10. Land Rights.

Seller shall obtain at its sole cost and expense all Land Rights that are required to construct, own, operate and maintain the Company-Owned Interconnection Facilities. Without limitation to the preceding sentence, Seller shall pay all surveying and mapping costs, appraisal fees, document preparation fees, recording fees or other costs. Seller shall use commercially reasonable efforts to obtain on behalf of the Company perpetual Land Rights for the Company-Owned Interconnection Facilities. Such Land Rights shall contain terms and conditions which are acceptable to Company and the documents setting forth the Land Rights shall be provided in advance of execution to Company for its review and approval and shall be recorded if required by Company. Following the Execution Date, Seller shall provide as part of the Monthly Progress Report the status of negotiations with landowner(s) regarding the Land Rights. Notwithstanding the foregoing, Company shall have the right in its sole discretion, at any time upon notice to Seller, to communicate directly with the landowner(s) and/or participate in the negotiations with landowner(s) for the Land Rights. For so long as Seller has the right under this Agreement to sell electric energy to Company, Seller shall pay for any rents and other payments due under such Land Rights that are associated with Company-Owned Interconnection Facilities.

11. Contracts for Company-Owned Interconnection Facilities.

For all contracts entered into by or on behalf of Seller for Company-Owned Interconnection Facilities to be designed, engineered and constructed, in whole or in part, by or on behalf of Seller, the following shall apply: (i) Company shall be made an intended third-party beneficiary of such contracts; and (ii) Company shall be provided with copies of such executed contracts, including the commercial terms.

[MATRIX TO BE INSERTED]

ATTACHMENT H
BILL OF SALE AND ASSIGNMENT

THIS BILL OF SALE AND ASSIGNMENT ("Bill of Sale"), made as of the ____ day of _____, 20____, by _____ ("Transferor") and _____ ("Transferee").

W I T N E S S E T H:

1. Bill of Sale. In consideration of the mutual covenants and agreements of Transferor and Transferee under the Power Purchase Agreement for Renewable Dispatchable Generation between Transferor and Transferee dated _____, 20__ ("PPA") and other good and valuable consideration, the receipt and sufficiency of which are hereby acknowledged, Transferor does hereby sell, assign and transfer over to Transferee all of Transferor's right, title and interest, in and to (i) all the tangible personal property and fixtures (including but not limited to the items set forth in Schedule H-1 (Description of Tangible Personal Property and Fixtures) attached hereto and incorporated herein), that constitutes what is referred to as the "Company-Owned Interconnection Facilities to be installed by or on behalf of Seller" (or words to similar effect) as set forth in Attachment G (Company-Owned Interconnection Facilities) to the PPA between [**Transferor and Transferee**] and (ii) the intangible personal property (including but not limited to the intangible personal property set forth in Schedule H-2 (Description of Intangible Personal Property) attached hereto and incorporated herein) owned by Transferor and used or to be used in the ownership, operation and maintenance of the aforesaid tangible personal property, to the extent assignable by Transferor, including without limitation, certificates of occupancy, permits, licenses, transferable warranties and guaranties, instruments, documents of title, and general intangibles pertaining to the aforesaid intangible personal property.

2. Warranty of Title. Transferor hereby warrants to Transferee that Transferor is the legal owner of the aforesaid tangible personal property and the aforesaid intangible personal property (including but not limited to the property set forth in Schedule H-1 (Description of Tangible Personal Property and Fixtures) and Schedule H-2 (Description of Intangible Personal Property)), and that said property is being sold, assigned and transferred to Transferee free and clear of all liens and encumbrances.

3. Governing Law. This Bill of Sale shall be governed by, and construed and interpreted in accordance with, the laws of the State of Hawai'i.

**[Signatures for Bill of Sale and Assignment
Appear on the Following Page]**

IN WITNESS WHEREOF, Transferor and Transferee have executed this instrument on the day and year first above written.

_____,
a _____

By _____
Its _____

"Transferor"

_____,
a Hawai'i corporation

By _____
Its _____

By _____
Its _____

"Transferee"

SCHEDULE H-1

**DESCRIPTION OF
TANGIBLE PERSONAL PROPERTY AND FIXTURES**

SCHEDULE H-2

DESCRIPTION OF INTANGIBLE PERSONAL PROPERTY

LAND COURT SYSTEM

REGULAR SYSTEM

Return by Mail () Pickup () To:

Tax Map Key Nos.:

Total pages: _____

ATTACHMENT I
ASSIGNMENT OF LEASE AND ASSUMPTION

THIS ASSIGNMENT is made as of this _____ day of _____, 20____, by _____, a _____, whose principal place of business and post office address is _____, hereinafter called the "Assignor," and _____, a Hawai'i corporation, whose principal place of business and post office address is _____, Honolulu, HI 968____, hereinafter called the "Assignee",

W I T N E S S E T H:

THAT the Assignor, for and in consideration of the sum of TEN DOLLARS (\$10.00) and other good and valuable consideration to it paid by the Assignee, the receipt and sufficiency of which are hereby acknowledged, and of the covenants and agreements of the Assignee hereinafter contained and on the part of the Assignee to be faithfully kept and performed, does hereby sell, assign, delegate, transfer, set over and deliver unto the Assignee, and its successors and assigns, all of Assignor's right, title and interest in and to the lease described in Schedule 1 (the "Lease"); together with

all interests thereto appertaining, and together with the personal property located on the land thereby demised.

And all of the estate, right, title and interest of the Assignor in and to the land thereby demised, and all buildings, improvements, rights, easements, privileges and appurtenances thereunto belonging or appertaining or used, occupied and enjoyed in connection with said Lease and the land thereby demised.

TO HAVE AND TO HOLD the same unto Assignee and its successors and assigns, for and during the respective unexpired term of said Lease, and as to said personal property (if any) absolutely and forever.

AND, in consideration of the premises, the Assignor does hereby covenant with the Assignee that the Assignor is the lawful owner of the herein described real property; that said Lease is in full force and effect and is not in default; that said real property is free and clear of and from all liens and encumbrances, except for the lien of real property taxes not yet by law required to be paid; that the Assignor is the lawful owner of said personal property (if any) and that Assignor's title thereto is free and clear of and from all liens and encumbrances, that the Assignor has good right to sell and assign said real property and personal property (if any) as aforesaid; and, that the Assignor will WARRANT AND DEFEND the same unto the Assignee against the lawful claims and demands of all persons, except as aforesaid.

AND, in consideration of the foregoing, the Assignee does hereby promise, covenant and agree to and with the Assignor and to and with said Lessor, that the Assignee will, effective as of and from the date of the execution and delivery of this instrument and during the residue of the term of said Lease, pay the rents thereby reserved as and when the same become due and payable pursuant to the provisions of said Lease, and will also faithfully observe and perform all of the covenants and conditions contained in said Lease which from and after the date hereof are or ought to be observed and performed by the lessee therein named, and will at all times hereafter indemnify and save harmless the Assignor from and against the nonpayment of said rent and the nonobservance or nonperformance of said covenants and conditions and each of them.

The terms "Assignor" and "Assignee", as and when used herein, or any pronouns used in place thereof, shall mean and

include the masculine, feminine or neuter, the singular or plural number, individuals, partnerships, trustees or corporations and their and each of their respective successors, heirs, personal representatives, successors in trust and assigns, according to the context hereof. All covenants and obligations undertaken by two or more persons shall be deemed to be joint and several unless a contrary intention is clearly expressed elsewhere herein. The term "Lease", as and when used herein, means the lease or sublease demising the leasehold estate described in Schedule 1, together with all recorded amendments thereof, if any, whether or not listed in Schedule 1. The term "rent", as and when used herein, means and includes all rents, taxes, assessments and any other sums charged pursuant to the Lease.

This instrument may be executed in any number of counterparts, each of which shall be deemed an original, but all of which shall constitute one instrument binding on all the Parties hereto, notwithstanding that all the Parties are not signatory to the original or the same counterpart.

[Signatures for Assignment of Lease and Assumption are on following page.]

IN WITNESS WHEREOF, Company and Assignor have executed
this instrument as of the date first above written.

By _____
Name:
Title:

By _____
Name:
Title:

"Assignor"

By _____
Name:
Title:

By _____
Name:
Title:

"Assignee"

STATE OF HAWAI'I)
) SS:
CITY AND COUNTY OF HONOLULU)

On this ____ day of _____, 200__, before me personally appeared _____ and _____, to me known to be the persons described in and who executed the foregoing instrument, and acknowledged that such persons executed such instrument as the free act and deed of such persons and if applicable in the capacity shown, having been duly authorized to execute such instrument in such capacity.

(Official Stamp or Seal)

Signature: _____
Print Name: _____
Notary Public, State of Hawai'i

My commission expires: _____

NOTARY CERTIFICATION STATEMENT

Document Identification or
Description: _____

Doc. Date _____ No. of Pages: _____

Jurisdiction: _____ Circuit
(in which notarial act is performed)

(Official Stamp or Seal)

Signature of Notary _____ Date of Notarization and
Certification Statement

Printed Name of Notary _____

STATE OF HAWAI'I)
) SS:
CITY AND COUNTY OF HONOLULU)

On this ____ day of _____, 200__, before me personally appeared _____ and _____, to me known to be the persons described in and who executed the foregoing instrument, and acknowledged that such persons executed such instrument as the free act and deed of such persons and if applicable in the capacity shown, having been duly authorized to execute such instrument in such capacity.

(Official Stamp or Seal)

Signature: _____
Print Name: _____
Notary Public, State of Hawai'i

My commission expires: _____

NOTARY CERTIFICATION STATEMENT

Document Identification or
Description: _____

Doc. Date _____ No. of Pages: _____

Jurisdiction: _____ Circuit
(in which notarial act is performed)

(Official Stamp or Seal)

Signature of Notary _____ Date of Notarization and
Certification Statement

Printed Name of Notary _____

SCHEDULE 1

- Description of Lease
- To Be Attached

ATTACHMENT J
COMPANY PAYMENTS FOR ENERGY AND DISPATCHABILITY

1. Price for Purchase of Electric Energy. Commencing on the Commercial Operations Date, Company shall pay Seller for electric energy delivered to the Point of Interconnection in response to Company Dispatch in accordance with this Agreement at the rate of \$[]/kWh.
2. Lump Sum Payment for Purchase of Dispatchability. Commencing on the Commercial Operations Date, Company shall pay Seller for the availability of the Facility's Net Energy Potential, subject to the Renewable Resource Variability, to respond to Company Dispatch in accordance with this Agreement, a monthly Lump Sum Payment as calculated and adjusted as set forth in Section 3 (Calculation of Lump Sum Payment) of this Attachment J (Company Payments for Energy and Dispatchability). The monthly Lump Sum Payment shall be calculated and adjusted to reflect changes in the estimate of the Facility's Net Energy Potential as such estimate is revised from time to time as more fully set forth in Attachment U (Calculation and Adjustment of Net Energy Potential) to this Agreement.
3. Calculation of Lump Sum Payment. The monthly Lump Sum Payment shall be calculated and adjusted as follows:
 - i. Lump Sum Payment During First Benchmark Period. During the First Benchmark Period, the monthly Lump Sum Payment shall be equal to one-twelfth (1/12th) of the product (rounded to the nearest cent) obtained by multiplying the Unit Price by the First NEP Benchmark.
 - ii. Lump Sum Payment During Second Benchmark Period.
 - a. One purpose of the Second Benchmark Period is to provide the Seller, in the event that the Initial NEP OEPR Estimate is less than NEP RFP Projection, with a limited period during which Seller will have an opportunity, by having a Subsequent OEPR prepared pursuant to Section 3(b) (Voluntary Subsequent OEPR) of Attachment U (Calculation Adjustment of Net Energy Potential) to this Agreement, to obtain an adjustment to the NEP OEPR Estimate

used to calculate the Lump Sum Payment, subject to (i) the cap on any upward adjustment imposed by the limitation that the estimate of Net Energy Potential that is used to calculate the Lump Sum Payment shall not exceed the NEP RFP Projection and (ii) the risk that any Subsequent OEPR might result in a downward adjustment to the NEP OEPR Estimate used to calculate the Lump Sum Payment. Accordingly, for each calendar month during the Second Benchmark Period, the monthly Lump Sum Payment shall be equal to one-twelfth ($1/12^{\text{th}}$) of the product (rounded to the nearest cent) obtained by multiplying the Unit Price by the lesser of the (w) the NEP RFP Projection or (x) the NEP OEPR Estimate of the OEPR that is most recent as of the first day of such calendar month. For avoidance of doubt:

1. On the first Day of the Second Benchmark Period, the most recent OEPR will be the Initial OEPR;
2. If no Subsequent OEPR is issued under Section 3 (Subsequent OEPRs) of Attachment U (Calculation and Adjustment of Net Energy Potential) to this Agreement for an OEPR Period of Record ending prior to the end of the third (3^{rd}) Contract Year, the "most recent OEPR" during the entirety of the Second Benchmark Period will be the Initial OEPR;
3. If any Subsequent OEPR is prepared for an OEPR Period of Record ending prior to the commencement of the fourth (4^{th}) Contract Year, the monthly Lump Sum Payment shall, for the period commencing on the first Day of the calendar month following the month during which an OEPR Evaluator issues such Subsequent OEPR, be equal to one-twelfth ($1/12^{\text{th}}$) of the product (rounded to the nearest cent) obtained by multiplying the Unit Price by the lesser of (w) the NEP OEPR

Estimate obtained from such Subsequent OEPR or (x) the NEP RFP Projection. The monthly Lump Sum Payment calculated as aforesaid shall remain in effect through the first to occur of (y) the end of the Term or (z) the end of the calendar month during which an OEPR Evaluator issues the next Subsequent OEPR (if any) that is required or permitted under Section 4 (Subsequent OPERs) of Attachment U (Calculation and Adjustment of Net Energy Potential) to this Agreement.

iii. Lump Sum Payment Following Second Benchmark Period.

- a. As of the first Day of the fourth (4th) Contract Year, the estimate of Net Energy Potential that was used to calculate the Lump Sum Payment for the last calendar month of the Second Benchmark Period shall continue in effect as the estimate of Net Energy Potential that is used to calculate the Lump Sum Payment until the end of the calendar month during which an OEPR Evaluator issues the first Subsequent OEPR for an OEPR Period of Record ending on or after the commencement of the fourth (4th) Contract Year and, effective at the end of such calendar month, the Second NEP Benchmark that was in effect immediately prior to the issuance of such Subsequent OEPR shall constitute the "Most Recent Prior NEP Benchmark" under clause (i) of the definition of that term set forth in this Agreement. For avoidance of doubt, if no Subsequent OEPR is issued for an OEPR Period of Record ending on or after the commencement of the fourth (4th) Contract Year, the Second NEP Benchmark that was used to calculate the Lump Sum Payment for the last calendar month of the Second Benchmark Period shall continue in effect for the balance of the Term as the estimate of Net Energy Potential that is used to calculate the Lump Sum Payment.

- b. In order to facilitate planning for the Company System, no increase in Net Energy Potential (and hence in the monthly Lump Sum Payment) shall be permitted under this Agreement as a consequence of any Subsequent OEPR that is prepared for an OEPR Period of Record ending on or after the expiration of the Second Benchmark Period. Accordingly, if any such Subsequent OEPR is prepared, the monthly Lump Payment shall, for the period commencing on the first Day of the calendar month following the month during which an OEPR Evaluator issues such Subsequent OEPR, be equal to one-twelfth ($1/12^{\text{th}}$) of the product (rounded to the nearest cent) obtained by multiplying the Unit Price by the lesser of (w) the NEP OEPR Estimate obtained from such Subsequent OEPR or (x) the Most Recent Prior NEP Benchmark. The monthly Lump Sum Payment calculated as aforesaid shall remain in effect through the first to occur of (y) the end of the Term or (z) the end of the calendar month during which an OEPR Evaluator issues the next following Subsequent OEPR (if any) that is required or permitted under Section 3 (Subsequent OEPRs) of Attachment U (Calculation and Adjustment of Net Energy Potential) to this Agreement. If any such next following Subsequent OEPR is issued, the monthly Lump Sum Payment shall, for the period commencing on the first Day of the calendar month following the calendar month during which an OEPR Evaluator issues such Subsequent OEPR, be re-calculated and adjusted as provided in this Section 3.iii.b of this Attachment J (Company Payments for Energy and Dispatchability) and shall continue in effect for the period provided in the preceding sentence.
- iv. Under the Company's previous forms of as-available power purchase agreements for renewable energy, the independent power producer was compensated for the production and delivery of electrical energy and assumed the risk of non-payment for events such as Force Majeure that prevented such production and delivery. Although under this

Agreement most of Seller's compensation will be in the form of a Lump Sum Payment rather than for the production and delivery of electrical energy, it is not the intent of the Parties that Seller should be entitled to unrestricted compensation in circumstances in which an independent power producer would not have been able to earn compensation under the Company's prior form of power purchase agreements (i.e., if the Facility or any portion thereof is unable to produce and deliver electric energy). Although the liquidated damages that are payable if the Availability Factor fails to achieve the Availability Benchmark addresses this issue when the Facility or a portion thereof is unable to generate electric energy because it is included in the Downtime classification under Section 2.5(a) (Calculation of the Availability Factor) of this Agreement, the Availability Factor does not account for events of Force Majeure because such events are included in the ExcludedTime classification under Section 2.5(a) (Calculation of the Availability Factor) of this Agreement. Accordingly, and without limitation to the generality of the foregoing provisions of this Section 3 (Calculation of Lump Sum Payment) of this Attachment J (Company Payments for Energy and Dispatchability), the monthly Lump Sum Payment shall be adjusted downward pro rata for each Day or portion thereof during the calendar month in question that the Facility or a portion thereof was not available to respond to Company Dispatch because of a Force Majeure condition (i) affecting the Facility or any portion thereof or (ii) that otherwise delays or prevents the Seller from making the Facility or a portion thereof available for Company Dispatch. For example, if a Facility has ten inverter(s) and, during the month of May (which has 31 calendar days), one inverter is not available to respond to Company Dispatch for a period of 15 Days due to a Force Majeure condition as aforesaid, the monetary amount of the resulting downward adjustment to the monthly Lump Sum Payment for the month of May would be calculated as follows:

$$\text{Monetary Amount of Downward Adjustment} = (\text{MLSP} \times 1/10) \times 15/31$$

where:

MLSP = The monthly Lump Sum Payment that would be payable but for the downward adjustment.

For purposes of determining the monetary amount of the foregoing downward adjustment, the product obtained by multiplying a monetary value by a fraction shall be rounded to the nearest cent.

4. Test Energy. Company shall use reasonable efforts to accept test energy that is delivered as part of the normal testing for generators (such as energy delivered to Company during the Control System Acceptance Test but not during the Acceptance Test), provided Seller shall use reasonable efforts to coordinate such normal testing with Company so as to minimize adverse impacts on the Company System and operations. Company shall not compensate Seller for test energy.
5. Tax Credits. Company acknowledges and agrees that the Refundable Tax Credit and Non-Refundable Tax Credit shall inure to the benefit of the Claiming Entity; provided, however, that Seller acknowledges and expressly agrees that the Refundable Tax Credit and Non-Refundable Tax Credit, with regard to Seller's Facility, have been calculated into the Contract Pricing based on the maximization of such credits. In the event that Seller's Facility does not gain the benefit of the Refundable Tax Credit and/or the Non-Refundable Tax Credit, Seller expressly acknowledges and agrees that it shall not seek to amend the Contract Pricing.

**[ATTACHMENT K WILL BE REVISED TO REFLECT
THE RESULTS OF IRS]**

ATTACHMENT K
GUARANTEED PROJECT MILESTONES

Guaranteed Project Milestone Date	Description of Each Guaranteed Project Milestone
The earlier of (i) date that is 30 Days following the Effective Date or (ii) [INSERT DATE BY WHICH EQUIPMENT MUST BE ORDERED TO MEET CONSTRUCTION SCHEDULE] ("Guaranteed Procurement Payment Date")	<u>Procurement Payment Milestone</u> : Seller shall make payment to Company of amount required under <u>Section 3(b)(iii)</u> (Balance of Company-Owned Interconnection Facilities Prepayment) of <u>Attachment G</u> (Company-Owned Interconnection Facilities).
[SPECIFY DATE CERTAIN]	<u>Permit Application Filing Milestone</u> : Provide Company with documentation reasonably satisfactory to Company evidencing the filing by or on behalf of Seller of the following applications for Governmental Approvals required for the ownership, construction, operation and maintenance of the Facility: [INSERT LIST OF GOVERNMENTAL APPROVALS]
[SPECIFY DATE CERTAIN]	<u>Construction Financing Milestone</u> : Provide Company with documentation reasonably satisfactory to Company evidencing (i) the closing on financing for the Facility or (ii) the financial capability to construct the Facility
[SPECIFY DATE CERTAIN]	<u>Guaranteed Commercial Operations Date</u> .

**[ATTACHMENT L WILL BE REVISED TO REFLECT
THE RESULTS OF IRS]**

ATTACHMENT L
REPORTING MILESTONES

Reporting Milestone Date	Description of Each Reporting Milestone
[Date]	Seller shall provide Company with a copy of the executed Facility equipment, engineering, procurement and construction (" <u>EPC</u> "), or other general contractor, agreements.
[Date]	Seller shall provide Company with copies of executed purchase orders/contracts for the delivery and installation of Facility turbine(s)/generator(s) and the step-up transformer(s).
[Date]	Seller shall provide Company with copies, as applicable, of executed Facility operating agreements, [electric transmission and/or interconnection agreements (?).]
[Date]	Construction Start Date (as defined in the Definitions section of the Agreement).
[Date]	Seller shall have laid the foundation for all Facility buildings, generating facilities and step-up transformer facilities.
[Date]	The turbine(s)/inverter(s) shall have been installed at the Site.
[Date]	The step-up transformer shall have been installed at the Site.
[Date]	Seller shall have constructed Seller's Interconnection Facilities and such facilities are capable of being

energized.

[Date]

The Acceptance Test of the Facility
commences.

ATTACHMENT M
FORM OF LETTER OF CREDIT

Page 1 of 2

[Bank Letterhead]

[Date]

Beneficiary: **[Hawaiian Electric Company, HELCO or MECO, as appropriate]**

[Address]

[Bank's Name]

[Bank's Address]

Re: **[Irrevocable Standby Letter of Credit Number]**

Ladies and Gentlemen:

We hereby establish, in your favor, our irrevocable standby Letter of Credit Number _____ (this "Letter of Credit") for the account of **[Applicant's Name]** and **[Applicant's Address]** in the initial amount of \$ _____ **[dollar value]** and authorize you, Hawaiian Electric Company **[HELCO or MECO, as appropriate]** ("Beneficiary"), to draw at sight on **[Bank's Name]**.

Subject to the terms and conditions hereof, this Letter of Credit secures **[Project Entity Name]**'s certain obligations to Beneficiary under the Power Purchase Agreement dated as of _____ between **[Project Entity Name]** and Beneficiary.

This Letter of Credit is issued with respect to the following obligations:_____.

This Letter of Credit may be drawn upon under the terms and conditions set forth herein, including any documentation that must be delivered with any drawing request.

Partial draws of this Letter of Credit are permitted. This Letter of Credit is not transferable. Drafts on us at sight shall be accompanied by a Beneficiary's signed statement signed by a representative of Beneficiary substantially as follows:

The undersigned hereby certifies that (i) I am duly authorized to execute this document on behalf of Hawaiian

Electric Company [**HELCO or MECO, as appropriate**], and [(ii) the amount of the draft accompanying this certification is due and owing to Hawaiian Electric Company [**or HELCO or MECO, as appropriate**] under the terms of the Power Purchase Agreement dated as of _____, between _____, and Hawaiian Electric Company [**or HELCO or MECO, as appropriate**]] [(ii) the Letter of Credit will expire in less than thirty (30) days, it has not been replaced or extended and collateral is still required under Section _____ of the Power Purchase Agreement*].

Such drafts must bear the clause "**Drawn under [Bank's Name and Letter of Credit Number _____ and date of Letter of Credit.]**"

All demands for payment shall be made by presentation of originals or copies of documents, or by facsimile transmission of documents to [**Bank Fax Number**] or other such number as specified from time to time by the bank. If presentation is made by facsimile transmission, you may contact us at [**Bank Phone Number**] to confirm our receipt of the transmission. Your failure to seek such a telephone confirmation does not affect our obligation to honor such a presentation. If presented by facsimile, original documents are not required.

This letter of credit shall expire one year from the date hereof. Notwithstanding the foregoing, however, this letter of credit shall be automatically extended (without amendment of any other term and without the need for any action on the part of the undersigned or Beneficiary) for one year from the initial expiration date and each future expiration date unless we notify you in writing at least thirty (30) days prior to any such expiration date that this letter of credit will not be so extended. Any such notice shall be delivered by registered or certified mail, or by FedEx, both to [**revise for HELCO or MECO, as appropriate**]:

Manager, Renewable Acquisition
Hawaiian Electric Company, Inc.
220 South King Street, 21st Floor
Honolulu, Hawai'i 96813

and to

SVP & Chief Financial Officer

* For draw relating to lapse of Letter of Credit while credit support is still required pursuant to the Power Purchase Agreement.

February 2018 RDG (PV) (2/1/18)

Hawaiian Electric Company, Inc.
900 Richards Street, 4th Floor
Honolulu, Hawai'i 96813

We hereby agree with drawers that drafts and documents as specified above will be duly honored upon presentation to **[Bank's Name]** and **[Bank's Address]** if presented on or before the then-current expiration date hereof.

Payment of any amount under this Letter of Credit by **[Bank]** shall be made as the Beneficiary shall instruct on the next Business Day after the date the **[Bank]** receives all documentation required hereunder, in immediately available funds on such date. As used in this Letter of Credit, the term "Business Day" shall mean any day other than a Saturday or Sunday or any other day on which banks in the State of Hawai'i are authorized or required by law to be closed.

Unless otherwise expressly stated herein, this irrevocable standby letter of credit is issued subject to the rules of the International Standby Practices, International Chamber of Commerce publication no. 590 ("ISP98").

[Bank's Name]:

By: _____
[Authorized Signature]

ATTACHMENT N
ACCEPTANCE TEST GENERAL CRITERIA

**[THIS ATTACHMENT WILL NEED TO BE MODIFIED
BASED ON THE TYPE AND DESIGN OF THE FACILITY]**

Upon final completion of Company review of the Facility's drawings, final test criteria and procedures shall be agreed upon by Company and Seller no later than thirty (30) Days prior to conducting the Acceptance Test in accordance with the Agreement. The Acceptance Test may include the following:

1. Interconnection:

- (a) Based on manufacturer's specification, test the local operation of the Facility's [REDACTED] kV breakers, which connect the Facility to Company System - must open and close locally using the local controls. Test and ensure that the status shown on the Energy Management System (EMS) is the same as the actual physical status in the field.
- (b) Remotely test the operation of the Facility's [REDACTED] kV breakers which connect the Facility to Company System - must open and close remotely from Company's EMS. Test and ensure that the status shown on the EMS is the same as the actual physical status in the field.
- (c) Relay test engineers to connect equipment and simulate certain inputs to test and ensure that the protection schemes such as any under/over frequency and under/over voltage protection or the Direct Transfer Trip operate as designed. (For example, a fault condition may be simulated to confirm that the breaker opens to sufficiently clear the fault. Additional scenarios may be tested and would be outlined in the final test criteria and procedures.) Seller to also test the synchronizing mechanisms to which the Facility would be synchronizing and closing into the Company System to ensure correct operation. Other relaying also to be tested as specified in the protection review of the IRS and on the single line diagram, Attachment E (Single-Line Drawing and Interface Block Diagram) for the Facility.

- (d) All [REDACTED] kV breaker disconnects and other high voltage switches will be inspected to ensure they are properly aligned and operated manually or automatically (if designed).
- (e) Switching Station inspections - The Switching Station may be inspected to test and ensure that the equipment that Seller has installed is installed and operating correctly based upon agreed-to design. Wiring may be field verified on a sample basis against the wiring diagrams to ensure that the installed equipment is wired properly. The grounding mat at the Switching Station may be tested to make sure there is adequate grounding of equipment.
- (f) Communication testing - Communication System testing to occur to ensure correct operation. Detailed scope of testing will be agreed by Company and Seller to reflect installed systems and communication paths to tie the Facility to Company's communications system.
- (g) Various contingency scenarios to be tested to ensure adequate operation, including testing contingencies such as loss of communications, and fault simulations to ensure that the Facility's [REDACTED] kV breakers open as they are designed to open. (Back up relay testing)

2. Witness of Facility protection scheme testing:

- (a) Company may have a representative on-site when Seller performs any testing dealing with Seller's protection schemes such as any under/over voltage or under/over frequency protection schemes to ensure they meet the performance requirements of this Agreement and the IRS.

3. Telephone Communication:

- (a) Test to confirm Company has a direct line to the Facility control room at all times and that it is programmed correctly.
- (b) Test to confirm that the Facility operators can sufficiently reach Company System Operator.

If agreed by the Parties in writing, some requirements may be postponed to the Control Systems Acceptance Test.

ATTACHMENT O
CONTROL SYSTEM ACCEPTANCE TEST CRITERIA

**[THIS ATTACHMENT WILL NEED TO BE MODIFIED
BASED ON THE TYPE AND DESIGN OF THE FACILITY]**

Final test criteria and procedures shall be agreed upon by Company and Seller no later than thirty (30) Days prior to conducting the Control System Acceptance Test ("CSAT") in accordance with Good Engineering and Operating Practices and with the terms of this Agreement. The Control System RTU Points List is necessary for the effective operation of the Company System and will be tested during the Control System Acceptance Test.

The Control System Acceptance Test is comprised of two parts, a set of onsite (at Facility) specific tests and a monitoring performance test. These tests may include the following:

On-site Tests:

1. SCADA Test to verify the status and analog telemetry, and if the remote controls between the Company's EMS and the Facility are working properly end-to-end.
2. Dispatch Test to verify if the Facility's active power limit controls and the Active Power Control Interface with the Company's EMS are working properly. The Test is generally conducted by setting different active power setpoints and limits and observing the proper dispatch of the appropriate ramp rate of the Facility's real power output.
3. Control Test for Voltage Regulation to verify the Facility can properly perform automatic voltage regulation as defined in this Agreement. Test is generally conducted by making small adjustments of the voltage setpoint and verifying by observation that the Facility regulates the voltage at the point of regulation to the setpoint by delivering/receiving reactive power to/from the Company System to maintain the applicable setpoint according to the reactive power control and the reactive amount requirements of Sections 3(a) (Reactive Power Control) and Section 3(b) (Reactive Amount) of Attachment B (Facility Owned by Seller) to this Agreement.
[DRAFTING NOTE: NEEDS TO BE REVISED FOR MECO FOR TESTING POWER FACTOR.]

4. Frequency Regulation Control Test to verify the Facility provides a frequency droop response as defined in this Agreement. Test is generally conducted by making adjustments of the frequency reference setting and verifying by observation that the Facility responds per droop and deadband settings.
5. Loss-of-Communication Test to verify the Facility will properly shutdown upon the failure of the direct-transfer-trip communication system. Test is generally conducted by simulating a communications failure and observing the proper shutdown of the Facility.

Monitoring Test:

- a) The monitoring test requires the Facility to operate as it would in normal operations.
- b) To ensure useful and valid test data is collected, the monitoring test shall end when one of the following criteria is met:
 - A. The Facility's power production is greater than 85% of its Allowed Capacity, for at least four (4) hours in any continuous 24-hour CSAT period.
 - B. The recorded renewable energy resource at the Facility is above **[600 W/m²] [a Measured Wind Speed of 9 meters per second]** for at least eight (8) hours in any continuous 48-hour CSAT period.
 - C. 14 continuous Days from the start of the CSAT.
- c) At the end of the test, an evaluation period is selected based on the criteria that triggered the end of the test.
- d) The performance of the Facility during the period of a successfully completed monitoring test is evaluated for, e.g., voltage regulation, frequency response, dispatch control, operating limits and ramp rate performance, to verify the performance meets the requirements of this Agreement. The Facility is considered to have complied with a requirement if the Facility was compliant with the requirement at least 99.0% of the time during the evaluation period and the Facility does not grossly violate the requirement when the Facility was in violation. The Parties understand and agree that these compliance conditions are limited only to determining whether the Facility successfully completes the CSAT monitoring test and are not for use in determining compliance during Commercial Operations, shall not be considered a waiver of any of the performance

standards of Seller, all of which are hereby reserved, and shall not alleviate Seller from any of its obligations under the Agreement.

ATTACHMENT P
SALE OF FACILITY BY SELLER

1. Company's Right of First Negotiation Prior to End of the Term.
 - (a) Right of First Negotiation. Should Seller ever desire to dispose of its right, title, or interest in the Facility, in whole or in part, other than the sale and leaseback of the Facility to provide financing for the Facility, it shall first offer to sell such interest at the fair market value to Company. Seller shall not solicit any offers for the sale of the Facility with any other entity without first negotiating with Company for at least six (6) months. The Parties may agree in writing to extend this period for negotiations. (Such 6-month period, as extended as aforesaid, is referred to herein as the "Right of First Negotiation Period".) During the Right of First Negotiation Period, the Parties shall negotiate in good faith concerning a purchase by Company unless, during that period, Company gives written notice that such negotiations are terminated. If, at the conclusion of the Right of First Negotiation Period, the Parties have not reached an agreement on the sale of the Facility to Company because the Parties cannot agree on the fair market value of the Facility, the fair market value of the Facility shall be determined in accordance with Section 3 (Procedure to Determine Fair Market Value of the Facility) of this Attachment P (Sale of Facility by Seller).
 - (b) Change in Ownership Interests and Control. Disposition of an interest in the Facility described in Section 1(a) (Right of First Negotiation) of this Attachment P (Sale of Facility by Seller) shall include and be deemed to include and occur upon:
 - (i) The disposition, sale, assignment or transfer, directly or indirectly, by merger, consolidation, reorganization, operation of law, or otherwise, of (A) any interest in Seller, and (B) any interest in any entity which holds a legal, beneficial or other interest in Seller, whether directly or through one or more intermediary entities (collectively, an "Ownership Interest"); or
 - (ii) The creation or issuance of ownership interests (whether shares, partnership interests, membership

interests, or other equity) which dilutes or reduces the existing ownership interests of any such entities, and (B) any change in the voting power or right to manage such entities (collectively, "Ownership Control"); provided, however, that Ownership Interest and Ownership Control shall not apply to an entity that is publicly traded on an established exchange.

Company's rights set forth in Section 1(a) (Right of First Negotiation) of this Attachment P (Sale of Facility by Seller) shall apply if in a single transaction or a series of related or unrelated transactions there is or will occur (A) a change of 50% or more in the Ownership Interest, or (B) any change in Ownership Control; provided, however, a sale or transfer of any interest in Seller or the Facility to one or more companies directly or indirectly controlling, controlled by or under common control with the Seller shall not trigger a right of first negotiation under Section 1(a) (Right of First Negotiation) of this Attachment P (Sale of Facility by Seller).

- (c) Purchase and Sale Agreement and PUC Approval. In the event that Company does exercise its right to purchase such interest in the Facility under Section 1(a) (Right of First Negotiation) of this Attachment P (Sale of Facility by Seller) and the Parties conclude a purchase and sale agreement, such agreement shall contain, at a minimum, the terms set forth in Section 4 (Purchase and Sale Agreement) of this Attachment P (Sale of Facility by Seller), and such agreement shall be subject to PUC approval as provided in Section 5 (PUC Approval) of this Attachment P (Sale of Facility by Seller).
- (d) Right of First Refusal. In the event the Parties fail to agree upon a sale of the Facility to Company (i) prior to the expiration of the Right of First Negotiation Period, or (ii) within thirty (30) Days of the determination of the Appraised Fair Market Value of the Facility as provided in Section 3 (Procedure to Determine Fair Market Value of the Facility) of this Attachment P (Sale of Facility by Seller), the provisions of this Section 1(d) (Right of First Refusal) shall apply if (aa) Seller thereafter offers to sell the Facility to a third party for less than (as applicable) the final amount Company had offered to purchase the Facility or the Appraised Fair Market Value or (bb) an

Ownership Interest that could result in a change of Ownership Control is offered for sale to a third party that is less than the proportionate share of (as applicable) the final amount Company had offered to purchase the Facility or the Appraised Fair Market Value. (By way of example, if the final amount offered by Company to purchase the Facility was \$100, and the Ownership Interest being offered for sale is 75%, the "proportionate share" is \$75, such that an offer to sell such Ownership Interest for less than \$75 would trigger this Section 1.1(d) (Right of First Refusal). Seller shall notify Company in writing of an offer that triggers this Section 1(d) (Right of First Refusal) and Company shall have the right to purchase the Facility for the amount of such offer on similar terms and conditions; provided that Company shall have three (3) months in which to notify Seller of its intent to exercise this right. If the offer of which Seller notifies Company as aforesaid is an offer to sell the Facility, Company shall have the right to purchase the Facility for the amount of such offer on similar terms and conditions. If the offer of which Seller notifies Company as aforesaid is an offer to sell an Ownership Interest that could result in a change in Ownership Control, Company shall have the right to purchase the Facility by a price that is proportionate to the amount at which such Ownership Interest was offered on the terms and conditions to be negotiated by the Parties on the basis of Section 4 (Purchase and Sale Agreement). (By way of example, if a 75% Ownership Interest is being offered for sale at \$75, the proportionate amount at which Company shall have the right to purchase the Facility would be \$100.)

- (e) Seller's Right to Transfer. In the event that Company does not exercise its right to purchase such interest in the Facility under Section 1(a) (Right of First Negotiation) of this Attachment P (Sale of Facility by Seller), Seller shall have the right to transfer or sell such interest to any person or entity which proposes to acquire the Facility with the intent to continue the operation of the Facility in accordance with the provisions of this Agreement pursuant to an assignment of this Agreement, subject to the prior written consent of Company, which consent shall not be unreasonably withheld, conditioned or delayed. Company will consent to the assignment of this Agreement to the purchaser

upon being reasonably satisfied that the assignee (i) has the qualifications or has contracted with an entity having the qualifications to operate the Facility in a manner consistent with the terms and conditions of this Agreement and (ii) has provided Company with evidence satisfactory to Company of its creditworthiness and ability to perform its financial obligations hereunder (including such guarantees as Company deems appropriate) in a manner consistent with the terms and conditions of this Agreement.

2. Company's Right of First Negotiation to Purchase at End of Term.

- (a) Option of Exclusive Negotiation Period. Company shall have the option of an exclusive negotiation period to negotiate a purchase of the Facility on the last Day of the Term, and all rights of Seller therein or relating thereto. Company shall indicate its preliminary interest in exercising the option for exclusive negotiation by delivering to Seller a notice of its preliminary interest not less than two (2) years prior to the last Day of the Term. If Company fails to deliver such notice by such date, Company's option shall terminate.
- (b) Negotiations. Once Company has given such notice of preliminary interest to Seller, for a period not to exceed three months, Company shall have the exclusive right to negotiate in good faith with Seller the terms of a purchase and sale agreement pursuant to which Company may purchase the Facility, which purchase and sale agreement shall include, without limitation, the terms set forth in Section 4 (Purchase and Sale Agreement) of this Attachment P (Sale of Facility by Seller). The Parties may agree in writing to extend this period for negotiations. (Such period, as extended as aforesaid, is referred to herein as the "Exclusive Negotiation Period.") Seller shall not solicit any offers or negotiate the terms for the sale of the Facility with any other entity during the Exclusive Negotiation Period, unless, during the Exclusive Negotiation Period, Company gives written notice that such negotiations are terminated. If, at the conclusion of the Exclusive Negotiation Period, the Parties have not reached an agreement on the sale of the Facility to Company because the Parties cannot agree on the fair market value of the Facility, the fair market value of

the Facility shall be determined in accordance with Section 3 (Procedure to Determine Fair Market Value of the Facility) of this Attachment P (Sale of Facility by Seller).

- (c) Purchase and Sale Agreement and PUC Approval. In the event that Company exercises its right of exclusive negotiation under Section 2(a) (Option of Exclusive Negotiation Period) of this Attachment P (Sale of Facility by Seller) and the Parties conclude a purchase and sale agreement pursuant to Section 2(b) (Negotiations) of this Attachment P (Sale of Facility by Seller), such agreement shall contain, at a minimum, the terms set forth in Section 4 (Purchase and Sale Agreement) of this Attachment P (Sale of Facility by Seller), and such agreement shall be subject to PUC approval as provided in Section 5 (PUC Approval) of this Attachment P (Sale of Facility by Seller).
- (d) Right of First Refusal. In the event the Parties fail to agree upon a sale of the Facility to Company
- (i) prior to the expiration of the Exclusive Negotiation Period provided in Section 2(b) (Negotiations) of this Attachment P (Sale of Facility by Seller), or
- (ii) within thirty (30) Days of the determination of the Appraised Fair Market Value of the Facility as provided in Section 3 (Procedure to Determine Fair Market Value of the Facility) of this Attachment P (Sale of Facility by Seller), and Seller thereafter offers to sell the Facility to a third party for less than the final amount Company had offered to purchase the Facility or the Appraised Fair Market Value (as applicable), Seller shall notify Company in writing of such offer and Company shall have the right to purchase the Facility for the amount of such offer and on no less favorable terms and conditions; provided, however, that Company shall have three (3) months in which to notify Seller of its intent to exercise this right.
3. Procedure to Determine Fair Market Value of the Facility.
- (a) If, at the conclusion of the Right of First Negotiation Period or the Exclusive Negotiation Period, or if the Parties have agreed to effectuate a sale of the Facility pursuant to Section 24.5 (Consolidation and Lease) and are unable to agree on the fair market value of the Facility, the Parties have not reached an agreement on the sale of the Facility to Company because the Parties

cannot agree on the fair market value of the Facility, each of Company and Seller shall engage the services of an independent appraiser experienced in appraising power generation assets similar to the Facility to determine separately the fair market value of the Facility. Subject to the appraisers' execution and delivery to Seller of a suitable confidentiality agreement in form reasonably acceptable to Seller, Seller shall provide both appraisers full access to the books, records and other information related to the Facility required to conduct such appraisal. Company shall pay all reasonable fees and costs of both appraisers, subject to Section 3(c) of this Attachment P (Sale of Facility by Seller). Each of Company and Seller shall use reasonable efforts to cause its appraisal to be completed within two (2) months following the engagement of the independent appraisers. If for any reason (other than failure by Seller to provide full access to Company's appraiser) one of the appraisals is not completed within such two (2) month period, the results of the other, completed appraisal shall be deemed to be the Appraised Fair Market Value of the Facility. Each Party may provide to both appraisers (with copies to each other) a list of factors which the Parties suggest be taken into consideration when the appraisers generate their appraisals.

- (b) Company and Seller shall exchange the results of their respective appraisals when completed and, in connection therewith, the Parties and their appraisers shall confer in an attempt to agree upon the fair market value of the Facility.
- (c) If, within thirty (30) Days after completion of both appraisals, the Parties cannot agree on a fair market value for the Facility, within ten (10) Days thereafter the first two appraisers shall by mutual consent choose a third independent appraiser. If the first two appraisers fail to agree upon a third appraiser, such appointment shall be made by DPR upon application of either Party. The Parties shall direct the third appraiser (i) to select one of the appraisals generated by the first two appraisers as the Appraised Fair Market Value of the Facility (without compromise, aka "baseball" arbitration), and (ii) to complete his or her work within one month following his or her retention. If the third appraiser selects the appraisal originally

generated by Seller's appraiser, Company shall pay the fees and costs of the third appraiser. If the third appraiser selects the appraisal originally generated by Company's appraiser, Seller shall pay the fees and costs of the third appraiser and shall pay or reimburse Company for the costs of Seller's original appraiser.

(d) The "Appraised Fair Market Value of the Facility" means the fair market value determined pursuant to Section 3(a) or Section 3(c) of this Attachment P (Sale of Facility by Seller) as applicable.

4. Purchase and Sale Agreement. The purchase and sale agreement concluded by the Parties pursuant to Section 1(a) (Right of First Negotiation) and Section 2(b) (Negotiations) of this Attachment P (Sale of Facility by Seller) (as applicable) shall contain, among other provisions, the following:

- (a) Seller shall, as of the closing of the sale, convey good and marketable title to the Facility and Site, including all rights of Seller in the Facility or relating thereto, free and clear of all liens, claims, encumbrances, or rights of others, except as approved by Company in writing;
- (b) Seller shall assign or otherwise make available to Company all of Seller's interest in all Project Documents and Governmental Approvals that are then in effect and that are utilized for the operation or maintenance of the Facility;
- (c) Seller shall execute and deliver to Company such deeds, bills of sale, assignments and other documentation as Company may request to convey good and marketable title to the Facility free from all liens, claims, encumbrances, or rights of others;
- (d) Seller shall cause all liens on the Facility for monies owed (including liens arising from Financing Documents), and any liens in favor of Seller's affiliates, to be released prior to closing on the sale of the Facility to Company;
- (e) Seller shall warrant, as of the date of the closing of the sale of the Facility to Company, good and marketable title to the Facility, free and clear of all other liens, claims, encumbrances and rights of others, except as approved by Company in writing;

- (f) Company shall have no liability for damages (including without limitation, any development and/or investment losses, liabilities or damages, and other liabilities to third parties) incurred by Seller on account of Company's purchase of the Facility, nor any other obligation to Seller except for the purchase price, and Seller shall indemnify Company against any such losses, liabilities or damages;
- (g) Company shall assume all of Seller's obligations with respect to the Facility accruing from and after the date of closing on the sale of the Facility to Company, including (i) to the extent assignable, all Permits held by, for, or related to the Facility, and (ii) all of Seller's agreements with respect to the Facility provided to and approved by Company at least [__] Days prior to the date of closing on the sale of the Facility to Company, except for such agreements Company has elected to terminate, in which case any related termination expenses shall be, at Company's option, paid directly by Company and deducted from the purchase price;
- (h) Seller shall indemnify Company against all of Seller's obligations with respect to the Facility accruing through the date of closing the sale of the Facility to Company;
- (i) Seller shall warrant that the Facility is in good operating order and repair, ordinary wear and tear excepted, in condition to perform in accordance with past practice, with no major maintenance items deferred, except as disclosed to and approved by Company in writing at least [__] Days prior to the date of closing on the sale of the Facility to Company;
- (j) Seller shall warrant that, except as disclosed to and approved by Company in writing at least [__] Days prior to the date of closing on the sale of the Facility to Company, the Facility conforms and has been operated by Seller in conformity with all Laws;
- (k) Seller shall warrant that Seller provided full access to Company and each appraiser in connection with the procedure to determine fair market value provided in Section 3 (Procedure to Determine Fair Market Value of the Facility); and

- (1) If applicable, Seller's lease of the Site from Company will terminate and Seller will relinquish all rights, privileges and obligations relating to such lease.
5. PUC Approval. Any purchase and sale agreement related to the Facility entered into by the Parties is subject to approval by the PUC and the Parties' respective obligations thereunder are conditioned upon receipt of such approval, except as specifically provided otherwise therein.
- (a) Company shall submit the purchase and sale agreement to the PUC for approval promptly after execution by both Parties, but Company does not extend any assurances that PUC approval will be obtained. Seller will provide reasonable cooperation to expedite obtaining an Approval Order from the PUC, including providing information requested by the PUC and parties to the PUC proceeding in which approval is being sought. Seller understands that lack of cooperation may result in Company's inability to file an application with the PUC and/or failure to receive PUC approval. For the avoidance of doubt, Company has no obligation to seek reconsideration, appeal, or other administrative or judicial review of any unfavorable PUC order. The Parties agree that neither Party has control over whether or not a PUC approval order will be issued and each Party hereby assumes any and all risk arising from, or relating in any way to, the inability to obtain a satisfactory PUC order and hereby releases the other Party from any and all claims relating thereto.
 - (b) Seller shall seek participation without intervention in the PUC docket for approval of the purchase and sale agreement pursuant to applicable rules and orders of the PUC. The scope of Seller's participation shall be determined by the PUC. However, Seller expressly agrees to seek participation for the limited purpose and only to the extent necessary to assist the PUC in making an informed decision regarding the approval of the purchase and sale agreement. If the Seller chooses not to seek participation in the docket, then Seller expressly agrees and knowingly waives the right to claim, before the PUC, in any court, arbitration or other proceeding, that the information submitted and the application requesting the PUC approval are insufficient to meet Company's burden of justifying that the terms of the purchase and sale agreement are just and reasonable and in the public interest, or otherwise deficient in any

manner for purposes of supporting the PUC's approval of the purchase and sale agreement. Seller shall not seek in the docket and Company shall not disclose any confidential information to Seller that would provide Seller with an unfair business advantage or would otherwise harm the position of others with respect to their ability to compete on equal and fair terms.

- (c) In order to constitute an Approval Order from the PUC under this Section 5 (PUC Approval) of this Attachment P (Sale of Facility by Seller), the order must approve the purchase and sale agreement, Company's funding arrangements and Company's acquisition of the Facility, shall not contain any terms and conditions deemed to be unacceptable by Company, and be in a form deemed reasonable by Company in its sole, but non-arbitrary, discretion.
- (d) The Final Non-Appealable Order from the PUC must be obtained within eighteen (18) months of the submission of the purchase and sale agreement to the PUC, or any extension of such period as agreed by the Parties in writing. The term "Final Non-appealable Order from the PUC" means an Approval Order from the PUC (i) that is not subject to appeal to any Circuit Court of the State of Hawai'i, Intermediate Court of Appeals of the State of Hawai'i, or the Supreme Court of the State of Hawai'i, because the period permitted for such an appeal has passed without the filing of notice of such an appeal, or (ii) that was affirmed on appeal to any Circuit Court of the State of Hawai'i, Intermediate Court of Appeals of the State of Hawai'i, or the Supreme Court of the State of Hawai'i, or was affirmed upon further appeal or appellate process, and that is not subject to further appeal, because the jurisdictional time permitted for such an appeal and/or further appellate process such as a motion for reconsideration or an application for writ of certiorari has passed without the filing of notice of such an appeal or the filing for further appellate process.
- (e) If a Final Non-Appealable Order from the PUC has not been obtained prior to the deadline provided in Section 5(b) of this Attachment P (Sale of Facility by Seller), either Party may give written notice to the other Party that it does not wish to proceed further with a sale of the Facility to Company.

- (f) If the Final Non-appealable Order from the PUC does not satisfy the conditions set forth in Section 5(a) of this Attachment P (Sale of Facility by Seller), either (i) Parties may agree to renegotiate and submit a revised purchase and sale agreement to the PUC, or (ii) either Party may give written notice to the other Party that it does not wish to proceed further with a sale of the Facility to Company.
6. Make Whole Amount. For purposes of Section 24.5 (Consolidation and Lease) the "Make Whole Amount" shall be equal to the sum of the following: (a) Seller's book value (including depreciation on a twenty-five (25) year straight line basis) of all actual verifiable costs of studies, designs, engineering, and construction of the Facility and all Interconnection Facilities (including any Company-Owned Interconnection Facilities paid for by Seller), including cancellation charges and other costs of unwinding construction and demobilization if the determination is made prior to the Commercial Operation Date, (b) Seller's book value of all actual verifiable costs and expenses acquiring real estate rights for the Facility and Interconnection Facilities, (c) Seller's book value of all actual verifiable costs and expenses incurred in obtaining Governmental Approvals, (d) Seller's book value of all actual verifiable costs of financing the Facility and the Interconnection Facility, including fees and expenses of bankers, consultants and counsel, and any discounts or premiums paid in connection with any financing, (e) any actual verifiable costs of repaying any financing in connection with a sale, including prepayment penalties or premiums, make whole payments, minimum interest payments, breakage fees, payments on account of taxes, duties and other costs, and other costs of unwinding swaps or other hedges, (f) other breakage, make whole or indemnity payments arising as the result of Company's purchase of the Facility, (g) tax costs, including recapture of federal or state tax credits and payment of transfer taxes, and (h) interest on the foregoing amounts at annual rate equal to the Prime Rate plus two percent (2%) as in effect from time to time from the date incurred through the date of payment, with all such costs being demonstrated by Seller with support and verified by Company. The items described in clauses (e), (f) and (g) (and clause (h) to the extent applicable to clauses (e), (f) and/or (g)) are referred to as the "Financial Termination Costs".

ATTACHMENT Q
[RESERVED]

ATTACHMENT R
REQUIRED INSURANCE

(See also Article 18 (Insurance))

1. Worker's Compensation and Employers' Liability. This coverage shall include Worker's Compensation, Temporary Disability and other similar insurance required by applicable State or U.S. federal laws. If exposure exists, coverage required by the Longshore and Harbor Worker's Compensation Act (33 U.S.C. §688) shall be included. Employers' Liability coverage limits shall be no less than:

Bodily Injury by Accident - \$1,000,000 each Accident
Bodily Injury by Disease - \$1,000,000 each Employee
Bodily Injury by Disease - \$1,000,000 policy limit

2. General Liability Insurance.

(i) This coverage shall include Commercial General Liability Insurance or the reasonable equivalent thereof, covering all operations by or on behalf of Seller. Such coverage shall provide insurance for bodily injury and property damage liability for the minimum limits of liability indicated below and shall include coverage for:

- (a) Premises, operations, and mobile equipment,
- (b) Products and completed operations,
- (c) Claims resulting from alleged damage to the environment and damage or injury caused by hazardous conditions or hazardous materials to the extent such coverage is appropriate and available at a commercially reasonable cost,
- (d) Blanket contractual liability,
- (e) Broad form property damage (including completed operations),
- (f) Explosion, collapse and underground hazard,
- (g) Personal injury liability, and
- (h) Failure to supply liability.

- (ii) Limits of liability for Bodily Injury & Property Damage shall be:
 - \$10,000,000 combined single limit per occurrence and;
 - \$20,000,000 aggregate annually
 - (iii) If coverage is written on a claims-made basis, the Seller warrants that any retroactive date applicable to coverage under the policy precedes the Execution Date; and that continuous coverage will be maintained or an extended discovery period will be exercised for a period of three (3) years beginning from the end of Term.
 - (iv) Coverage limits may be satisfied using Umbrella and/or Excess Liability insurance policies.
3. Automobile Liability Insurance. This insurance shall include coverage for owned, leased and non-owned automobiles. The minimum limits of liability shall be a combined single limit for bodily injury and property damage of Two Million Dollars (\$2,000,000) for each occurrence and in the aggregate annually. The policy shall be endorsed to include Transportation Pollution Liability insurance, covering hazardous materials to be transported by Seller, as appropriate.
4. Builders All Risk Insurance. This insurance shall include but not be limited to coverage for wind including named windstorm, earthquake, flood, perils, property in transit (excluding ocean transit), off-site storage - property in temporary storage or assembly away from the project site, testing, covering all materials, equipment, machinery and supplies of any nature whatsoever, the property of the Seller or of others for which the Seller may have assumed responsibility, used or to be used in or incidental to the site preparation, demolition of existing structures, erection and/or fabrication and/or reconstruction and/or repair of the project insured, including temporary works (all scaffolding, formworks, fences, shoring, hoarding, false work and temporary buildings and all incidental to the project) from the start of construction through the earlier of the Commercial Operations Date or the effective date of the policy coverage set forth in Section 5 (All Risk Property/Comprehensive Boiler and Machinery Insurance (Upon Completion of Construction)). The amount of coverage shall be purchased on a full replacement cost basis, except for earthquake and flood perils which shall be no less than Twenty Million Dollars (\$20,000,000), if such insurance

amounts are appropriate and available on commercially reasonable terms. The coverage shall be written on an "All Risks" completed value form and may allow for reasonable other sublimits for transit and for incidental offsite storage. Coverage shall be extended to include testing. Such policies shall be endorsed to require that the coverage afforded shall not be canceled (except for nonpayment of premiums) or reduced without at least thirty (30) Days' prior written notice to Seller and Company; provided, however, that such endorsement shall provide (i) that the insurer may not cancel the coverage for non-payment of premium without giving Seller and Company ten (10) Days' notice that Seller has failed to make timely payment thereof, and (ii) that, subject to the consent of the Facility Lender, Seller or Company shall thereupon have the right to pay such premium directly to the insurer.

5. All Risk Property/Comprehensive Boiler and Machinery Insurance (Upon Completion of Construction). This insurance shall provide All Risk Property Coverage (including the perils of wind including named windstorm, earthquake, and flood) and Comprehensive Boiler and Machinery Coverage against damage to the Facility. The amount of coverage shall be purchased on a full replacement cost basis (no coinsurance shall apply) except for earthquake and flood perils which shall be no less than Twenty Million Dollars (\$20,000,000), if such insurance amounts are appropriate and available on commercially reasonable terms. Such coverage may allow for other reasonable sublimits. Such policies shall be endorsed to require that the coverage afforded shall not be canceled (except for nonpayment of premiums) or reduced without at least thirty (30) Days' prior written notice to Seller and Company; provided, however, that such endorsement shall provide (i) that the insurer may not cancel the coverage for non-payment of premium without giving Seller and Company ten (10) Days' notice that Seller has failed to make timely payment thereof, and (ii) that, subject to the consent of the Facility Lender, Seller or Company shall thereupon have the right to pay such premium directly to the insurer.

6. Business Interruption Insurance (Upon Completion of Construction). This insurance shall provide coverage for all of Seller's costs to the extent that they would not be eliminated or reduced by the failure of the Facility to operate for a period of at least twelve (12) months following a covered physical damage loss deductible period or reasonable dollar deductible.

7. Project Liability Errors and Omissions. Seller shall obtain adequate protection against project liability errors and omissions on account of negligent actions or inactions of architects, engineers, contractors and subcontractors involved in the design and/or construction of the Facility. This protection may be provided through any one or more of the following mechanisms: (i) construction contract(s) with the above parties who have sufficient financial creditworthiness to cover project liability errors and omissions; (ii) other agreement(s) with the above parties; or (iii) reserve account(s) which may be used to correct material deficiencies associated with the Facility as a result of negligent actions or inactions of the above parties.

8. Ocean Transit. Seller shall take reasonable action to ensure that the risk of loss or damage to any material items of equipment which are subject to ocean transit is adequately protected against by the terms of delivery from contractors or suppliers of such equipment or Seller's own insurance coverage.

ATTACHMENT S
FORM OF MONTHLY PROGRESS REPORT

1. Instructions

Any capitalized terms used in this report which are not defined herein shall have the meaning ascribed to them in the Power Purchase Agreement for Renewable As-Available Energy by and between _____, a **[Delaware limited liability company]** ("Seller"), and **[HECO/HELCO/MECO, as appropriate]**, a Hawai'i corporation, dated _____, (the "Agreement").

In addition to the remedial action plan requirement set forth in Article 13 of the Agreement, Seller shall review the status of each Construction Milestone of the construction schedule (the "Schedule") for the Facility and identify such matters referenced in clauses (i)-(v) below as known to Seller and which in Seller's reasonable judgment are expected to adversely affect the Schedule, and with respect to any such matters, shall state the actions which Seller intends to take to ensure that the Construction Milestones will be attained by their required dates. Such matters may include, but shall not be limited to:

(i) Any material matter or issue arising in connection with a Government Approval, or compliance therewith, with respect to which there is an actual or threatened dispute over the interpretation of a law, actual or threatened opposition to the granting of a necessary Governmental Approvals, any organized public opposition, any action or expenditure required for compliance or obtaining approval that Seller is unwilling to take or make, or in each case which could reasonably be expected to materially threaten or prevent financing of the Facility, attaining any Construction Milestone, or obtaining any contemplated agreements with other parties which are necessary for attaining any Construction Milestone or which otherwise reasonably could be expected to materially threaten Seller's ability to attain any Construction Milestone.

(ii) Any development or event in the financial markets or the independent power industry, any change in taxation or accounting standards or practices or in Seller's business or prospects which reasonably could be expected to materially threaten financing of the Facility, attainment of any Construction Milestone or materially threaten any contemplated agreements with other parties which are necessary for attaining any Construction Milestone or could otherwise reasonably be expected to materially threaten Seller's ability to attain any Construction Milestone;

(iii) A change in, or discovery by Seller of, any legal or regulatory requirement which would reasonably be expected to materially threaten Seller's ability to attain any Construction Milestone;

(iv) Any material change in the Seller's schedule for initiating or completing any material aspect of the Facility;

(v) The status of any matter or issue identified as outstanding in any prior Monthly Progress Report and any material change in the Seller's proposed actions to remedy or overcome such matter or issue.

For the purpose of this report, "EPC Contractor" means the contractor responsible for engineering, procurement and construction of the Facility, including Seller if acting as contractor, and including all subcontractors.

2. Executive Summary

2.1 Major activities completed

Please provide a cumulative summary of the major activities completed for each of the following aspects of the Facility (provide details in subsequent sections of this report):

- 2.1.1 **[Insert Construction Milestones from Attachment K and Attachment L, if needed]**
- 2.1.2 Financing
- 2.1.3 Governmental Approvals for Development
- 2.1.4 Site Control
- 2.1.5 Land Rights for Company-Owned Interconnection Facilities
- 2.1.6 Design and Engineering
- 2.1.7 Major Equipment Procurement
- 2.1.8 Construction
- 2.1.9 Interconnection

2.1.10 Startup Testing and Commissioning

2.2. Major activities recently performed

Please provide a summary of the major activities performed for each of the following aspects of the Facility since the previous report (provide details in subsequent sections of this report):

- 2.2.1 [Insert Construction Milestones from Attachment K and Attachment L, if needed]**
- 2.2.2 Financing
- 2.2.3 Development Permits
- 2.2.4 Site Control
- 2.2.5 Land Rights for Company-Owned Interconnection Facilities
- 2.2.6 Design and Engineering
- 2.2.7 Major Equipment Procurement
- 2.2.8 Construction
- 2.2.9 Interconnection
- 2.2.10 Startup Testing and Commissioning

2.3 Major activities planned but not completed

Please provide a summary of the major activities that were planned to be performed since the previous report but not completed as scheduled, including the reasons for not completing the activities, for each of the following aspects of the Facility:

- 2.3.1 [Insert Construction Milestones from Attachment K and Attachment L, if needed]**
- 2.3.2 Financing
- 2.3.3 Governmental Approvals for Development
- 2.3.4 Site Control

- 2.3.5 Land Rights for Company-Owned Interconnection Facilities
- 2.3.6 Design and Engineering
- 2.3.7 Major Equipment procurement
- 2.3.8 Construction
- 2.3.9 Interconnection
- 2.3.10 Startup Testing and Commissioning

2.4 Major activities expected during the current month

Please provide a summary of the major activities to be performed during the current month for each of the following aspects of the Facility (provide details in subsequent sections of this report):

- 2.4.1 Construction Milestones
- 2.4.2 Financing
- 2.4.3 Governmental Approvals
- 2.4.4 Site Control
- 2.4.5 Land Rights for Company-Owned Interconnection Facilities
- 2.4.6 Design and Engineering
- 2.4.7 Major Equipment procurement
- 2.4.8 Construction
- 2.4.9 Interconnection
- 2.4.10 Startup Testing and Commissioning

3. Milestones

3.1 Milestone schedule

Please list all Construction Milestones specified in Attachment K and Attachment L and state the current status of each.

Construction Milestone	Milestone Date Specified in the Agreement	Status (e.g., on schedule, delayed due to [<i>specify reason</i>]; current expected completion date)
-----------------------------------	--	--

3.2 Remedial Action Plan (if applicable)

Provide a detailed description of Seller's course of action and plan to achieve the missed Construction Milestones and all subsequent Construction Milestones by the Guaranteed Commercial Operation Date using the outline provided below.

- 3.2.1 Identify Missed Construction Milestone
- 3.2.2 Explain plans to achieve missed Construction Milestone
- 3.2.3 Explain plans to achieve subsequent Construction Milestones
- 3.2.4 Identify and discuss (a) delays in engineering schedule, equipment procurement, and construction and interconnection schedule and (b) plans to remedy delays as a result of the missed Construction Milestones

4. Financing

Please provide the schedule Seller intends to follow to obtain financing for the Facility. Include information about each stage of financing.

Activity (e.g., obtain \$xx for yy stage from zz)	Completion Date
	__/__/____ (expected / actual)
	__/__/____ (expected / actual)

5. Project Schedule

Please provide a copy of the current version of the overall Facility schedule (e.g., Work Breakdown Structure, Gantt chart, MS Project report, etc.). Include all major activities for Governmental Approvals for Development, design and engineering, procurement, construction, interconnection and testing.

6. Governmental Approvals

6.1 Environmental Impact Review

Please provide information about the primary environmental impact review for the Facility. Indicate whether dates are expected or actual.

Agency

Date of application/submission

__/__/____
(expected /
actual)

Date application/submission deemed complete by agency

__/__/____
(expected /
actual)

Date of initial study (if applicable)

__/__/____
(expected /
actual)

Process (e.g., Notice of Exemption, Negative Declaration, Mitigated Negative Declaration, Environmental Impact Report)

Date of Notice of Preparation

__/__/____
(expected /
actual)

Date of Draft ND/MND/EIR

___/___/_____
(expected /
actual)

**Date Notice of Determination filed at
OPR or County Clerk**

___/___/_____
(expected /
actual)

Governmental Approvals

Please describe each of the Governmental Approvals to be obtained by Seller and the status of each:

Status Summary

e.g., dates of application / hearing / notice / etc. (note whether dates are anticipated or actual); major activities (indicate whether planned, in progress and/or completed); primary reasons for possible delay, etc.

Agency / Approval

6.3 Governmental Approval activities recently performed

Please list all Governmental Approval activities that occurred since the previous report.

6.4 Governmental Approval activities expected during the current month

Please list all Governmental Approval activities that are expected to occur during the current month.

6.5 Governmental Approval Notices received from EPC Contractor

Please attach to this Monthly Progress Report copies of any notices related to Governmental Approval activities received since the previous report, whether from EPC Contractor or directly from Governmental Authorities.

7. Site Control

7.1 Table of Site Control schedule

If not obtained prior to execution of the Agreement, please provide the schedule Seller intends to follow to obtain control of the Site (e.g., purchase, lease).

Activity	Completion Date
	__/__/____ (expected / actual)
	__/__/____ (expected / actual)

7.2 Site Control activities recently performed

Please explain in detail the property acquisition activities that were performed since the previous report.

7.3 Site Control activities expected during the current month

Please explain in detail the site control activities that are expected to be performed during the current month.

8. Land Rights for the Company-Owned Interconnection Facilities

8.1 Table of Land Rights schedule for Company-Owned Interconnection Facilities

If not obtained prior to execution of the Agreement, please provide the schedule Seller intends to follow to obtain control of the Land for the Company-Owned Interconnection Facilities (e.g., purchase, lease).

Activity	Completion Date
	__/__/____ (expected / actual)
	__/__/____ (expected / actual)

8.2 Land Control activities recently performed

Please explain in detail the property acquisition activities that were performed since the previous report.

8.3 Land Control activities expected during the current month

Please explain in detail the Land control activities that are expected to be performed during the current month.

9. Design and Engineering

9.1 Design and engineering schedule

Please provide the name of the EPC Contractor, the date of execution of the EPC Contract, and the date of issuance of a full notice to proceed (or equivalent).

Please list all major design and engineering activities, both planned and completed, to be performed by Seller and the EPC Contractor.

Name of EPC Contractor / Subcontractor	Activity	Completion Date
		__/__/____ (expected / actual)
		__/__/____ (expected / actual)

9.2 Design and engineering activities recently performed

Please explain in detail the design and engineering activities that were performed since the previous report.

9.3 Design and engineering activities expected during the current month

Please explain in detail the design and engineering activities that are expected to be performed during the current month.

10. Major Equipment Procurement

10.1 Major equipment to be procured

Please list all major equipment to be procured by Seller or the EPC Contractor:

Equipment Description	Manufacturer	Delivery Date (indicate whether expected or actual)	Installation Date (indicate whether expected or actual)
		___/___/___ (expected / actual)	___/___/___ (expected / actual)
		___/___/___ (expected / actual)	___/___/___ (expected / actual)

Equipment Description	No. Ordered	No. Made	No. On-Site	No. Installed	No. Tested

10.2 Major Equipment procurement activities recently performed

Please explain in detail the major equipment procurement activities that were performed since the previous report.

10.3 Major Equipment procurement activities expected during the current month

Please explain in detail the major equipment procurement activities that are expected to be performed during the current month.

11. Construction

11.1 Construction activities

Please list all major construction activities, both planned and completed, to be performed by Seller or the EPC Contractor.

Activity	EPC Contractor / Subcontractor	Completion Date
		___/___/_____ (expected / actual)
		___/___/_____ (expected / actual)

11.2 Construction activities recently performed

Please explain in detail the construction activities that were performed since the previous report.

11.3 Construction activities expected during the current month

Please explain in detail the construction activities are expected to be performed during the current month.

11.4 EPC Contractor Monthly Construction Progress Report

Please attach a copy of the Monthly Progress Reports received since the previous report from the EPC Contractor pursuant to the construction contract between Seller and EPC Contractor, certified by the EPC Contractor as being true and correct as of the date issued.

12. Interconnection

12.1 Interconnection activities

Please list all major interconnection activities, both planned and completed, to be performed by Seller or the EPC Contractor.

Activity	Name of EPC Contractor / Subcontractor	Completion Date
		___/___/_____ (expected / actual)
		___/___/_____ (expected / actual)

12.2 Interconnection activities recently performed

Please explain in detail the interconnection activities that were performed since the previous report.

12.3 Interconnection activities expected during the current month

Please explain in detail the interconnection activities that are expected to be performed during the current month.

13. Startup Testing and Commissioning

13.1 Startup testing and commissioning activities

Please list all major startup testing and commissioning activities, both planned and completed, to be performed by Seller or the EPC Contractor.

Activity	Name of EPC Contractor / Subcontractor	Completion Date
		__/__/____ (expected / actual)
		__/__/____ (expected / actual)

13.2 Startup testing and commissioning activities recently performed

Please explain in detail the startup testing and commissioning activities that were performed since the previous report.

13.3 Startup testing and commissioning activities expected during the current month

Please explain in detail the startup testing and commissioning activities that are expected to be performed during the current month.

14. Safety and Health Reports

14.1 Accidents

Please describe all Facility-related accidents reported since the previous report.

14.2 Work stoppages

Please describe all Facility-related work stoppages from that occurred since the previous report.

Please describe the effect of work stoppages on the Facility schedule.

15. Certification

I, _____, on behalf of and as an authorized representative of [_____], do hereby certify that any and all information contained in this Seller's Monthly Progress Report is true and accurate, and reflects, to the best of my knowledge, the current status of the construction of the Facility as of the date specified below.

By: _____

Name: _____

Title: _____

Date: _____

ATTACHMENT T
MONTHLY REPORTING AND DISPUTE
RESOLUTION BY INDEPENDENT AF EVALUATOR

1. Monthly Report. Commencing with the month during which the Commercial Operations Date is achieved, and for each calendar month thereafter during the Term, Seller shall provide to Company a Monthly Report in Excel, Lotus or such other format as Company may require, which Monthly Report shall include (i) the data for the calendar month in question populated into the form of "Monthly Report" below and (ii) Seller's calculations of the performance metrics and any liquidated damages assessments for the LD Period ending with such calendar month as set forth below. Seller shall deliver such Monthly Report to Company by the fifth (5th) Business Day following the close of the calendar month in question. Seller shall deliver the Monthly Report electronically to the address provided by the Company. Company shall have the right to verify all data set forth in the Monthly Report by inspecting measurement instruments and reviewing Facility operating records. Upon Company's request, Seller shall promptly provide to Company any additional data and supporting documentation necessary for Company to audit and verify any matters in the Monthly Report.

Monthly Report

NAME OF IPP FACILITY: [Facility Name]

MONTHLY REPORT PERIOD: [Month Day, Year] to [Month Day, Year]

DOWNTIME DURING MONTHLY REPORT PERIOD

DownTime Event No.	Event Date	Start Time	End Time	Number of Seconds for Event	Number of Inverters Unavailable for Event	DownTime for Event (# of Unavailable Inverters X # of Seconds for Event)

Total number of inverters installed at Facility: _____

Total number of seconds in monthly report period: _____

Total number of inverter-seconds (i.e., 1 installed inverter for 1 second) in monthly report period: _____

Total number of inverter-seconds of DownTime in monthly report period (sum of "DownTime for Event" column): _____

Monthly Report (continued)

EXCLUDEDTIME DURING MONTHLY REPORT PERIOD

ExcludedTime Event No.	Event Date	Start Time	End Time	Number of Seconds for Event	Number of Inverters Unavailable for Event	ExcludedTime for Event (# of Unavailable Inverters X # of Seconds for Event)	Reason for ExcludedTime Event

Total number of inverter-seconds of ExcludedTime in monthly report period
(sum of "ExcludedTime for Event" column): _____

**PERFORMANCE METRICS FOR LD PERIOD (i.e., 12-month period ending with
month covered by Monthly Report)**

Availability Factor

Total number of inverter-seconds for the 11 months prior to
month covered by Monthly Report: _____

Total number of inverter-seconds of DownTime for the
11 months prior to month covered by Monthly Report: _____

Total number of inverter-seconds of ExcludedTime for the
11 months prior to month covered by Monthly Report: _____

Availability Factor for LD Period: _____

Amount (if any) by which Availability Factor for LD Period
falls below Availability Benchmark: _____

Liquidated Damages (if any) assessed for falling below
Availability Benchmark: _____

Lump Sum Payment due for month covered by Monthly Report: _____

GPR Benchmark

GPR Benchmark for LD Period: _____

GPR Benchmark as adjusted for applicable degradation factor: _____

95% of adjusted GPR Benchmark to establish threshold for
LD assessment: _____

Measured Performance Ratio ("MPR") for LD Period: _____

Amount (if any) by which MPR for LD Period falls below
threshold for LD assessment set forth above: _____

Liquidated Damages (if any) assessed for falling below
LD threshold: _____

Lump Sum Payment due for month covered by Monthly Report: _____

2. Disagreements Concerning Availability Factor, GPR Benchmark and Measured Production Ratio.

- (a) Notice of Disagreement With Monthly Report. Within five (5) Business Days following the close of the calendar month in question, Seller shall provide to Company the Monthly Report for such calendar month and the LD Period ending with such calendar month, as provided in Section 1 (Monthly Report) of this Attachment T (Monthly Reporting and Dispute Resolution by Independent AF Evaluator). Within ten (10) Business Days after Company's receipt of a Monthly Report, Company shall provide written notice to Seller of any disagreement with any matter concerning such Monthly Report, including the data for the calendar month covered by such Monthly Report, Seller's calculation of the Availability Factor for the LD Period ending with such calendar month ("AF Disagreement") or Seller's calculation of Measured Performance Ratio for the LD Period ending with such calendar month ("MPR Disagreement"). Together with any such notice of disagreement ("Notice of Disagreement"), the Company shall include its own calculations and other support for its position. If Company fails to provide a Notice of AF Disagreement or a Notice of MPR Disagreement within said 10-Business Day period, the Monthly Report provided by Seller shall be deemed to be accepted by Company and shall no longer be subject to dispute by Company or Seller.
- (b) Notice of Disagreement With GPR Benchmark Determination. If Seller disagrees with either (i) the GPR Benchmark derived by Company pursuant to Section 2.6(b) (Determination of GPR Benchmark) of this Agreement or (ii) Company's claim that it is unable to reasonably derive such GPR Benchmark, Seller shall, within thirty (30) Days after receipt of Company's written notice of the GPR Benchmark pursuant to Section 2.6(b) (Determination of GPR Benchmark), provide written notice to Company of Seller's disagreement with either (i) the GPR Benchmark derived by Company as aforesaid or (ii) Company's claim that it is unable to reasonably derive a GPR Benchmark ("GPR Benchmark Disagreement"). Together with such notice of disagreement ("Notice of GPR Benchmark

Disagreement"), the Seller shall include its own calculation and other support for its position. If Seller fails to provide such notice within such 30-Day period, the GPR Benchmark designated in Company's written notice shall be deemed to be accepted by Seller and shall no longer be subject to dispute by Company or Seller. For avoidance of doubt, if Company claims that it is unable to reasonably derive a GPR Benchmark from, as applicable, the IE Energy Assessment Report and supporting data on plane of array irradiance and corresponding power output or any written clarification of an Initial OEPR or Subsequent OEPR issued by an OEPR Evaluator, Company shall be deemed to have designated a GPR Benchmark of **0.9**.

- (c) Submission of Monthly Report Disagreement to Independent AF Evaluator. Upon issuance of a Notice of Disagreement, the Parties shall review the contents of the Monthly Report(s) together with such Notice of Disagreement and attempt to resolve such Monthly Report Disagreement. If the Parties are able to agree on a resolution of any Monthly Disagreement, the resulting corrected Monthly Report(s) in question shall be set forth in a writing executed by both Parties, following which (i) such corrected Monthly Reports shall no longer be subject to dispute by either Party and (ii) to the extent such resolution of such Monthly Report Disagreement affects future Monthly Reports, such future Monthly Reports shall be prepared, and the Availability Factor and Measured Performance Ratio in such future Monthly Reports shall be calculated, in a manner consistent with such resolution. If the Parties are unable to resolve such Monthly Report Disagreement within thirty (30) Days after Company's issuance of such Notice of Monthly Report Disagreement, either Party may, within five (5) Business Days after the end of such 30-Day period, submit the unresolved Monthly Report Disagreement to an Independent AF Evaluator for resolution.
- (d) Submission of GPR Benchmark Disagreement to Independent AF Evaluator. Upon issuance of a notice of GPR Benchmark Disagreement, the Parties shall review, as applicable, the IE Energy Assessment Report and the supporting data on plane of array irradiance

and corresponding power output, the Initial OEPR, the supporting data on plane of array irradiance and corresponding power output and any written clarification of the Initial OEPR issued by the OEPR Evaluator who prepared the Initial OEPR, and any Subsequent OEPR, the supporting data on plane of array irradiance and corresponding power output and any written clarification of such Subsequent OEPR issued by the OEPR Evaluator who prepared the Subsequent OEPR, together with such Notice of GPR Benchmark Disagreement, and attempt to resolve such GPR Benchmark Disagreement. If the Parties are able to agree on a resolution of any GPR Benchmark Disagreement, the resulting corrected GPR Benchmark shall be set forth in writing executed by both Parties, following which such corrected GPR Benchmark shall constitute the GPR Benchmark for the period in question. If the Parties are unable to resolve such GPR Benchmark Disagreement within thirty (30) Days after Seller's issuance of such Notice of GPR Benchmark Disagreement, either Party may, within five (5) Business Days after the end of such 30-Day period, submit the unresolved GPR Benchmark Disagreement to an Independent AF Evaluator for resolution. The authority of the Independent AF shall be limited to deciding the following issues:

- i. If Company derived a GPR Benchmark from, as applicable, (i) the IE Energy Assessment and the supporting data on plane of array irradiance and corresponding power output, (ii) the Initial OEPR, the supporting data on plane of array irradiance and corresponding power output and/or any written clarification issued by the OEPR Evaluator who prepared the Initial OEPR, or (iii) a Subsequent OEPR, the supporting data on plane of array irradiance and corresponding power output and/or any written clarification issued by the OEPR Evaluator who prepared such Subsequent OEPR, the authority of the Independent AF Evaluator shall be limited to deciding:

- (aa) Is the GPR Benchmark derived by Company reasonably supported by the document and data set from which it was derived as aforesaid?; and
 - (bb) If not, what is the GPR Benchmark that is best supported by such document and data set?
- ii. If Company claimed that is was unable to reasonably derive a GPR Benchmark, the authority of the Independent AF Evaluator shall be limited to deciding:
- (aa) Was Company correct in claiming that a GPR Benchmark cannot be reasonably derived from the document and data set in question?; and
 - (bb) If Company was not correct, what is the GPR Benchmark that is best supported by such document and data set?

For avoidance of doubt, because **0.9** is the GPR Benchmark that shall apply to any period for which a GPR Benchmark cannot be reasonably be derived from the applicable document as aforesaid, the Independent AF Evaluator shall not have the authority to resolve a GPR Benchmark Dispute by performing an independent evaluation of the Facility to estimate, among other things, its performance ratio, in order to arrive at an independent determination of an GPR Benchmark.

- (e) Appointment of Independent AF Evaluator. If either Party decides to submit an unresolved AF Disagreement, an unresolved GPR Benchmark Disagreement or an unresolved MPR Disagreement to an Independent AF Evaluator, it shall provide written notice to that effect (the "Submission Notice") to the other Party, which notice shall designate which of the engineering firms on the OEPR Consultants List is to act as the Independent AF Evaluator for purposes of resolving such dispute; provided, however, for purposes of

facilitating consistency in the resolution of Monthly Report Disagreements, all Monthly Report Disagreements arising out of any one or more of the twelve (12) Monthly Reports issued for a given Contract Year shall be submitted to the same Independent AF Evaluator unless such Independent AF Evaluator declines to accept any such submission(s). A Submission Notice must be provided within the 5-Business Day period provided in Section 2(c) (Submission of Monthly Report Disagreement to Independent AF Evaluator). The Parties shall each pay fifty percent (50%) of the fees and expenses charged by the Independent AF Evaluator.

- (f) Eligibility for Appointment as Independent AF Evaluator. Both Parties agree that the engineering firms listed in Section 4(h) of Attachment U (Calculation and Adjustment of Net Energy Potential) are fully qualified to serve as Independent AF Evaluator. Prior to the end of any Contract Year, either Party may remove a particular consultant from the OEPR Consultants List by giving written notice of such removal to the other Party, which removal (i) will have effect as of January 31st of the immediately following Contract Year but (ii) will not divest such Independent AF Evaluator of its authority to decide any disagreements submitted to such Independent AF Evaluator on or before such January 31st. However, neither Party may remove a name or names from the OEPR Consultants List without approval of the other Party if such removal would leave the list without any names. Proposed additions to the OEPR Consultants List shall automatically become effective thirty (30) Days after notice is received by the other Party unless written objection is made by such other Party within said thirty (30) Day period. By written agreement between the Parties, a new name or names may be added to the OEPR Consultants List at any time.
- (g) Participation of Parties. Promptly following the issuance of a Submission Notice as provided in Section 2(e) (Appointment of Independent AF Evaluator) of this Attachment T (Monthly Reporting and Dispute Resolution by Independent AF Evaluator), Seller and Company shall provide the Independent AF Evaluator which such data as they consider to be material to the resolution of the disputed issue(s). Seller and

Company shall also provide such additional data and information as the Independent AF Evaluator may reasonably request. The Parties shall assist the Independent AF Evaluator throughout the process of resolving such dispute, including making key personnel and records available to the Independent AF Evaluator, but neither Party shall be entitled to participate in any meetings with personnel of the other Party or review of the other Party's records. However, the Independent AF Evaluator will have the right to conduct meetings, hearing or oral arguments in which both Parties are represented.

- (h) Written Decision of Independent AF Evaluator. The terms of engagement with the Independent AF Evaluator shall require the Independent AF Evaluator to issue its written decision resolving the disputed issues submitted to it within the applicable time period set forth below, which time periods are subject to any tolling that may be applicable pursuant to Section 2(i) (Sequence to Resolving Inter-related Disagreements) of this Attachment T (Monthly Reporting and Dispute Resolution by Independent AF Evaluator):
- (i) 30 Days as measured from the issuance of the Submission Notice; or
 - (ii) such other time period as the Parties may agree in writing.

Unless otherwise agreed by the Parties in writing: (i) for an AF Disagreement, the written decision of the Independent AF Evaluator shall set forth (aa) for the calendar month in question, the correct TotalTime, the correct DownTime and the correct ExcludedTime as determined by such Independent AF Evaluator if any such was in dispute and (bb) for the LD Period ending with the calendar month in question the Availability Factor for such LD Period as determined by such Independent AF Evaluator if such Availability Factor was in dispute; (ii) for a MPR Disagreement, the written decision of the Independent AF Evaluator shall set forth the Measured Performance Ratio for the applicable LD Period as determined by such Independent AF Evaluator; and (iii) for a GPR Benchmark Disagreement, the written decision of the Independent

AF Evaluator shall: (aa) confirm that the GPR Benchmark derived by the Company was reasonably derived and state that such percentage constitutes the GPR Benchmark; or (bb) confirm the Company's conclusion that it is unable to reasonably derive a GPR Benchmark and state that **0.9** is the GPR Benchmark; or (cc) disagree with the Company's conclusion that it is unable to reasonably derive a GPR Benchmark, state the percentage that is the best-supported GPR Benchmark, and state that such percentage constitutes the GPR Benchmark.

(i) Sequence for Resolving Interrelated Disagreements.

- (i) If at the time AF Disagreement is submitted to an Independent AF Evaluator pursuant to Section 2(e) (Appointment of Independent AF Evaluator) of this Attachment T (Monthly Reporting and Dispute Resolution by Independent AF Evaluator) there are one or more other unresolved AF Disagreements concerning the same LD Period that are pending before a different Independent AF Evaluator, and the resolution of such other AF Disagreement(s) is necessary to the resolution of the AF Disagreement that has been newly submitted to a new Independent AF Evaluator as aforesaid, the time period for such new Independent AF Evaluator to issue its written decision resolving such newly submitted AF Disagreement shall be tolled until such pending AF Disagreement(s) have been resolved. For avoidance of doubt, it is the intent of the Parties that disagreements over availability data and calculations for a given calendar month shall (i) not be subject to resolution twice and (ii) once resolved, shall not be reopened.
- (ii) If a GPR Benchmark Disagreement is unresolved at the time a MPR

Disagreement is submitted to an Independent AF Evaluator pursuant to Section 2(e) (Appointment of Independent AF Evaluator) of this Attachment T (Monthly Reporting and Dispute Resolution by Independent AF Evaluator), and the resolution of such GPR Disagreement is necessary to the resolution of such MPR Disagreement, the time period for an Independent AF Evaluator to issue its written decision resolving such MPR Disagreement shall be tolled until the resolution of such GPR Benchmark Disagreement pursuant to either Section 2(d) (Submission of GPR Benchmark Disagreement to Independent AF Evaluator) or Section 2(h) (Written Decision of Independent AF Evaluator) of this Attachment T (Monthly Reporting and Dispute Resolution by Independent AF Evaluator).

- (iii) If at the time MPR Disagreement is submitted to an Independent AF Evaluator pursuant to Section 2(e) (Appointment of Independent AF Evaluator) of this Attachment T (Monthly Reporting and Dispute Resolution by Independent AF Evaluator) there are one or more other unresolved MPR Disagreements concerning the same LD Period that are pending before a different Independent AF Evaluator, and the resolution of such other MPR Disagreement(s) is necessary to the resolution of the MPR Disagreement that has been newly submitted to a new Independent AF Evaluator as aforesaid, the time period for such new Independent AF Evaluator to issue its written decision resolving such newly submitted MPR Disagreement shall be tolled until such pending MPR Disagreement(s) have been resolved. For avoidance of doubt, it is the

intent of the Parties that disagreements over performance ratio data and calculations for a given calendar month shall (i) not be subject to resolution twice and (ii) once resolved, shall not be reopened.

- (j) Final, Conclusive and Binding. The Parties acknowledge the inherent uncertainty in calculating the Availability Factor and the Measured Performance Ratio, and hereby assume the risk of such uncertainty and waive any right to dispute the qualification of the person or entity appointed as the Independent AF Evaluator pursuant to Section 2(e) (Appointment of Independent AF Evaluator) of this Attachment T (Monthly Reporting and Dispute Resolution by Independent AF Evaluator) and/or the appropriateness of the methodology used by Independent AF Evaluator in resolving such AF Disagreement or MPR Disagreement. Without limitation to the generality of the preceding sentence, the decision of the Independent AF Evaluator as to each AF Disagreement and each MPR Disagreement submitted to an Independent AF Evaluator shall be final, conclusive and binding upon Company and Seller and shall not be subject to further dispute under Article 28 (Dispute Resolution) of the Agreement.
3. Periodic Review of Method of Calculating and Reporting Availability and Measured Performance Ratio. At least once per Contract Year, Company shall review the method of calculating and reporting availability and the Measured Performance Ratio under this Agreement method to determine if other variables should be incorporated into such calculations.
4. Future Changes in Reporting Requirements. Seller shall reasonably cooperate with any Company requested revisions to the Monthly Report to include additional data that may be necessary from time to time to enable Company to comply with any new reporting requirements directed by the PUC or otherwise imposed under applicable Laws.

ATTACHMENT U
CALCULATION AND ADJUSTMENT OF NET ENERGY POTENTIAL

1. Net Energy Potential.

(a) Net Energy Potential and the Intent of the Parties. The essence of this Agreement is that Company is paying to Seller a Lump Sum Payment in exchange for Company's right to dispatch, subject to Renewable Resource Variability, the Facility's Net Energy Potential. Under this Agreement, "Net Energy Potential": (i) constitutes an estimated single number with a P-Value of 95 for annual Net Energy that could be produced by the Facility based on the estimated long-term monthly and annual total of such production over a period of ten years; (ii) is subject to adjustment from time to time as provided in this Attachment U (Calculation and Adjustment of Net Energy Potential); and (iii) as so adjusted, provides a basis for calculating and adjusting the Lump Sum Payment, as provided in Section 3 (Calculation of Lump Sum Payment) of Attachment J (Company Payments for Energy and Dispatchability) to this Agreement. It is the intent of the Parties that the estimate of Net Energy Potential, as calculated and adjusted as foresaid, should reflect the following risk allocation between the Parties under this Agreement:

(i) Seller has assumed the risk of downward adjustment to the Net Energy Potential (and hence the Lump Sum Payment) to account for any of the following circumstances:

(aa) if the Renewable Resource Baseline (as estimated on the basis of the typical meteorological year as derived from the Site's measured meteorological data) is lower than Seller had assumed when it submitted its **[Response to RFP]**;

(bb) if the as-built design and construction of the Facility is not as efficient in generating electrical energy and delivering such electric energy to the Point of Interconnection as Seller had assumed when it submitted its **[Response to RFP]**; and

- (cc) if the Facility's level of operational efficiency is below the standard of comparable facilities;
- (ii) Company has assumed the risk of the following (i.e., the following are to be disregarded for purposes of estimating Net Energy Potential (and hence the Lump Sum Payment)):
 - (aa) Renewable Resource Variability; and
 - (bb) the possibility that, at any given moment, Company does not need to dispatch any or all of the electric energy that the Facility is then capable of generating and delivering to the Point of Interconnection.

The foregoing is not intended as an exhaustive list of the risks assumed by either Party under this Agreement or as a limitation on the circumstances that an OEPR Evaluator, in its professional judgment, may decide to take into account in preparing its OEPR under Section 4(e) (Terms of Engagement) of this Attachment U (Calculation and Adjustment of Net Energy Potential).

- (b) NEP RFP Projection. In its response to RFP, the Seller projected that the Facility would have a Net Energy Potential (as defined in this Agreement) of MWh [REDACTED] **[VALUE TO BE INSERTED]** and provided the plane of array irradiance data used in arriving at the NEP RFP Projection, and Company relied on Seller's NEP RFP Projection in deciding to contract with Seller in lieu of other developers. Among the fundamentals of the bargain evidenced in this Agreement is that there will be consequences to Seller if (i) the IE Energy Assessment does not support the NEP RFP Projection and/or (ii) the operational performance of the Facility indicates a Net Energy Potential that is below the applicable thresholds set forth in this Attachment U (Calculation and Adjustment of Net Energy Potential).
- (c) NEP IE Estimate and Company-Designated NEP Estimate. The Seller shall require the Facility Lender to provide Company with a copy of the IE Energy Assessment Report and the data on plane of array irradiance and corresponding power output used in arriving at the NEP IE Estimate. Notwithstanding any other provision of this Agreement to the contrary, Company shall have no obligation to co-

operate with the Facility Lender or execute any documents in connection with the Financing Documents unless (i) Company has received a copy of the IE Energy Assessment Report and the data on plane of array of irradiance and corresponding power output used in arriving at the NEP IE Estimate and (ii) the Facility Lender represents to Company that the IE Energy Assessment Report is the latest energy assessment prepared for the Facility Lender as part of the Facility Lender's due diligence leading up to the Facility Lender's legally binding commitment to provide a specific amount of financing for the Project as evidenced by the Facility Lender's execution of the Financing Documents. If the two conditions set forth in the preceding sentence are not satisfied, or if the IE Energy Assessment Report fails to provide a NEP IE Estimate that is consistent with the requirements of this Agreement, or if the data on plane of array of irradiance and corresponding power output used in arriving at the NEP IE Estimate is not provided, Company shall have the option, exercisable by written notice to Seller issued no later than **[30]** Days, or such longer period as the Parties may agree in writing, following the first to occur of Company's receipt of (i) the IE Energy Assessment Report or (ii) notice that Company will not be provided with a copy of the IE Energy Assessment Report and the data on plane of array of irradiance and corresponding power output used in arriving at the NEP IE Estimate, to (aa) designate such Company-Designated NEP Estimate as Company, in its sole discretion, determines to be reasonable in light of the information then available to Company or (bb) declare this Agreement null and void. In connection with Company's decision as to whether to designate a Company-Designated NEP Estimate, Company shall have the right to require Seller to pay for an energy assessment to be performed by an independent engineer selected by Company. In such case, the aforesaid 30-Day period for Company's decision to designate a Company-Designated NEP Estimate or to declare this Agreement null and void shall be tolled for the time necessary to prepare such assessment. If Company fails, within the aforesaid 30-Day period as such period may be tolled as provided in the preceding sentence, to either designate a Company-Designated NEP Estimate or to declare this Agreement null and void, the NEP RFP Projection shall constitute the First NEP Benchmark, unless the Parties agree in writing on a lower First NEP Benchmark.

- (d) NEP IE Estimate, Liquidated Damages and Seller's Null and Void Right. If the NEP IE Estimate is higher than the NEP RFP Projection, the NEP RFP Projection shall constitute the First NEP Benchmark. In any other case, Seller shall have the option to declare this Agreement null and void by written notice to Company as follows:
- (i) if (aa) the NEP IE Estimate is lower than the NEP RFP Projection and (bb) Seller issues its null and void notice to Company not later than **[30]** Days after issuance of the IE Energy Assessment Report; or
 - (ii) if (aa) Company exercises its right to designate a Company-Designated NEP Estimate under Section 1(c) of this Attachment U (Calculation and Adjustment of Net Energy Potential), (bb) such Company-Designated NEP Estimate is lower than the NEP RFP Projection, and (cc) Seller issues its null and void notice to Company not later than **[30]** Days after Company's notice of the Company-Designated NEP Estimate.

If Seller fails to declare this Agreement null and void under the conditions set forth in either clause (i) or clause (ii) above, then: (x) the NEP IE Estimate or the Company-Designated NEP Estimate, as applicable, shall thereafter constitute the First NEP Benchmark and (y) Seller shall, within five (5) Business Days following the expiration of the applicable 30-Day period for the issuance of Seller's null and void notice, pay liquidated damages equal to **[\$10]** for every MWh by which the NEP RFP Projection exceeds the First NEP Benchmark.

2. Initial OEPR. Following the first Day of the calendar month following the calendar month during which there occurs the first anniversary of the Commercial Operations Date, the Initial OEPR shall be prepared pursuant to the process set forth in Section 4 (Preparation of OEPR) of this Attachment U (Calculation and Adjustment of Net Energy Potential) and the Initial NEP OEPR Estimate shall be as set forth in or derived from the Initial OEPR, as more fully set forth in Section 4(e) (Terms of Engagement) of this Attachment U (Calculation and Adjustment of Net Energy Potential). If the Initial NEP OEPR Estimate differs from the First NEP Benchmark, the Lump Sum Payment shall be recalculated and adjusted as provided in Section 3.ii (Lump Sum Payment During Second Benchmark Period) of Attachment J (Company Payments for Energy and Dispatchability) to this Agreement.

3. Subsequent OEPRs.

- (a) Required Subsequent OEPR. If Seller makes any changes to the Facility that involve (i) replacing any step-up transformer(s) or (ii) making any other changes (e.g., changing the characteristics of the Facility equipment or the specifications used in the IRS) that Company reasonably determines require an updated IRS, then Seller shall also be required to have a subsequent OEPR prepared as of the first Day of the calendar month following the second anniversary of the date such change to the Facility was completed.
- (b) Voluntary Subsequent OEPR. Without limitation to the generality of Section 3(a) (Required Subsequent OEPR) of this Attachment U (Calculation and Adjustment of Net Energy Potential), if the Seller makes any changes to the Facility (e.g., replacing original equipment) that does not trigger a required Subsequent OEPR but which changes Seller has reasonable grounds to believe will improve the Facility's Net Energy Potential, Seller shall have a one-time option, exercisable by written notice to Company issued not less than [120] Days prior to the Applicable NEP Verification Date, of having a subsequent OEPR prepared as of a date no sooner than 12 months following completion of the then most recent OEPR.
- (c) Subsequent OEPR and Adjustment to Lump Sum Payment. If the Subsequent NEP OEPR Estimate differs from the Most Recent Prior NEP Benchmark, the Lump Sum Payment shall be recalculated and adjusted as provided in Section 3.iii (Lump Sum Payment Following Second Benchmark Period) of Attachment J (Company Payment for Energy and Dispatchability) to this Agreement.

4. Preparation of OEPR. The following provisions apply to the Initial OEPR and any Subsequent OEPR:

- (a) Selection of OEPR Evaluator. No later than [90] Days prior to the Applicable NEP Verification Date, Company shall select from the engineering firms listed on the OEPR Consultants List an independent engineer (the "OEPR Evaluator") to prepare an operational energy production report ("OEPR").
- (b) Eligibility for Appointment as OEPR Evaluator. Both Parties agree that the engineering firms listed in Section

4(h) of this Attachment U (Calculation and Adjustment of Net Energy Potential) are fully qualified to prepare the OEPR. Prior to the end of any Contract Year, either Party may remove a particular consultant from the OEPR Consultants List by giving written notice of such removal to the other Party, which removal (i) will have effect as of January 31st of the immediately following Contract Year but (ii) will not divest such OEPR Evaluator of its authority to prepare any OEPR for which it was selected on or before such January 31st. However, neither Party may remove a name or names from the OEPR Consultants List without approval of the other Party if such removal would leave the list without any names. Proposed additions to the OEPR Consultants List shall automatically become effective thirty (30) Days after notice is received by the other Party unless written objection is made by such other Party within said thirty (30) Day period. By written agreement between the Parties, a new name or names may be added to the OEPR Consultants List at any time.

- (c) OEPR Period of Record. It is the intent of the Parties that the OEPR shall be prepared using measured meteorological and production data from the OEPR Period of Record. However, although the OEPR Period of Record is a twelve-month period, the Parties acknowledge that, in certain circumstances (e.g., Force Majeure), there may not be twelve months of data available for the OEPR Period of Record. In such case, (i) it is the intent of the Parties that the OEPR be prepared using such measured meteorological and production data that is available from the OEPR Period of Record and (ii) Parties may, by written agreement, direct the OEPR Evaluator to use such additional data outside of the OEPR Period of Record as the Parties may agree. The preceding sentence does not constitute a limitation on the professional judgment of the OEPR Evaluator as to the appropriateness of using measured meteorological and/or production from outside of the OEPR Period of Record.
- (d) Participation of Parties. Promptly following the Applicable NEP Verification Date, Seller and Company shall provide the OEPR Evaluator which such data from the OEPR Period of Record as they consider to be material to the preparation of the OEPR. Seller and Company shall also provide such additional data and information as the OEPR Evaluator may reasonably request. The Parties shall assist the OEPR Evaluator throughout the process of

preparing the OEPR, including making key personnel and records available to the OEPR Evaluator, but neither Party shall be entitled to participate in any meetings with personnel of the other Party or review of the other Party's records. However, the OEPR Evaluator will have the right to conduct meetings, hearing or oral arguments in which both Parties are represented.

- (e) Terms of Engagement. The terms of engagement with the OEPR Evaluator must be acceptable to Company and shall, among other things, require the OEPR to provide (i) an estimated single number with a P-Value of 95 for annual Net Energy that could be produced by the Facility based on the estimated long-term monthly and annual total of such production over a period of ten years and (ii) the data on plane of array of irradiance and corresponding power output used in arriving at the aforementioned estimated annual Net Energy for purposes of allowing the Parties to determine the GPR Benchmark as provided in Section 2.6(b)(ii) (Commencing With Initial OEPR) or Section 2.6(b)(iii) (Commencing With First Subsequent OEPR and Thereafter) of this Agreement, as applicable. The provisions of this Attachment U (Calculation and Adjustment of Net Energy Potential) do not impose a limit on the OEPR's professional judgment as to what other estimates (if any) to include in the OEPR. Without limiting the professional judgment of the OEPR Evaluator in estimating the Net Energy Potential and GPR Benchmark, the following is a general description of how the Parties anticipate that the OEPR Evaluator will proceed:

The purpose of an OEPR is to implement the intent of the Parties as set forth in Section 1(a) (Net Energy Potential and the Intent of the Parties) of this Attachment U (Calculation and Adjustment of Net Energy Potential) by evaluating (i) whether, when the Renewable Resource Baseline (as estimated by the OEPR Evaluator on the basis of the typical meteorological year as derived from the Site's measured meteorological data) is present and the Facility is in Full Dispatch, the Facility is capable of doing what the Parties expected the Facility to do: i.e., generating and delivering to the Point of Interconnection electric energy in an

amount consistent with the then applicable Net Energy Potential of the Facility (i.e., the estimate of Net Energy Potential then being used to calculate the monthly Lump Sum Payment pursuant to Section 3 (Calculation of Lump Sum Payment) of Attachment J (Company Payments for Energy and Dispatchability to this Agreement); and (ii) if the Facility is not doing what the parties expected in this regard, identifying a new estimated single number with a P-Value of 95 for annual Net Energy that could be generated and delivered by the Facility based on the estimated long-term monthly and annual total of such production over a period of the next ten years.

At a high level, the analysis relies on reported Actual Output during the OEPR Period of Record to estimate Facility performance over a future evaluation period of ten years. The data from the OEPR Period of Record are first quality screened and evaluated. One-time events are assessed and removed from the record where appropriate. Values for potential energy are then calculated from the reported energy production measured at the Point of Interconnection by adjusting for 100% availability and undispached energy. Suitable long-term reference data sets are then identified by analyzing the reference for irradiance and the normalized values for potential energy production at the Point of Interconnection over the OEPR Period of Record. Relationships between selected long-term reference irradiance data sets and normalized values for potential energy production at the Point of Interconnection are used to calculate long-term values for such on a monthly and annual basis. Finally, estimates of future Facility availability (taking into account anticipated maintenance) and losses (such as system degradation and balance of plant losses) are applied in order to calculate

the Net Energy Potential. For this purpose, no reductions are made for future estimates of energy that Company may choose not to dispatch. If a copy of the IE Energy Assessment Report is available to the OEPR Evaluator, the OEPR Evaluator should review such Report before commencing preparation of the OEPR and evaluate whether it is appropriate for the OEPR Evaluator to take into account any of the work reflected in the IE Energy Assessment Report.

- (f) Timeline and Fees. The terms of engagement with the OEPR Evaluator shall require the OEPR Evaluator to issue the OEPR with 30 Days following the NEP Applicable Verification Date. The Parties shall each pay fifty percent (50%) of the fees and expenses charged by the OEPR Evaluator in connection with the Initial OEPR. Seller shall pay all of the fees and expenses charged by the OEPR Evaluator in connection with any Subsequent OEPR.
- (g) Final, Binding and Conclusive. The Parties acknowledge the inherent uncertainty in estimating the Net Energy Potential and hereby assume the risk of such uncertainty and waive any right to dispute any of the qualification of the person or entity appointed as the OEPR Evaluator pursuant to Section 4(a) (Selection of OEPR Evaluator) and Section 4(b) (Eligibility for Appointment as OEPR Evaluator) of this Attachment U (Calculation and Adjustment of Net Energy Potential) of this Agreement, the appropriateness of the methodology used by OEPR Evaluator in preparing the OEPR, and/or the NEP OEPR Estimate. Without limitation to the generality of the preceding sentence, the determination of the NEP OEPR Estimate in the OEPR or (as more fully set forth in the definition of NEP OEPR Estimate) on the basis of the OEPR, shall be final, conclusive and binding upon Company and Seller and shall not be subject to further dispute under Article 28 (Dispute Resolution) of the Agreement.
- (h) Acceptable Persons and Entities. The following are acceptable as an OEPR Evaluator, subject to such additions or deletions effectuated by the Parties as provided in Section 2(f) (Eligibility for Appointment as Independent AF Evaluator) of Attachment T (Monthly Reporting and Dispute Resolution by Independent AF Evaluator) to this

Agreement and Section 4(b) (Eligibility for Appointment as
OEPR Evaluator) of this Attachment U (Calculation and
Adjustment of Net Energy Potential):

DNV GL

AWS Truepower

Black & Veatch

Leidos Engineering

ATTACHMENT V
**SUMMARY OF MAINTENANCE AND INSPECTION PERFORMED
IN PRIOR CALENDAR YEAR**

(See Article 5)

DATE WORK ORDER SUBMITTED: 06/28/96
WO#: 11451
EQUIPMENT #: 1CCF-TNK-1
EQUIPMENT DESCRIPTION: AMMONIA STORAGE TANK 1
PROBLEM DESCRIPTION: PURCHASE EMERGENCY ADAPTER FITTINGS FOR
UNLOADING GASPRO TANKS TO STORAGE TANK

WORK PERFORMED: PURCHASED THE NEW ADAPTERS AND VERIFIED THEIR
OPERATION.

COMPLETION DATE: 06/28/96
WORK ORDER COMPLETED BY: AA

-----END OF CURRENT WORK ORDER-----

DATE WORK ORDER SUBMITTED: 05/19/96
WO#: 11136
EQUIPMENT #: 1WSA-BV-12
EQUIPMENT DESCRIPTION: MAKE-UP PI ISOLATION
PROGRAM DESCRIPTION: 'D' MAKE-UP PUMP PI ISOLATION FITTING LEAKING ON
SPOOL SIDE

WORK PERFORMED: REMOVED AND REPLACED FITTINGS AND FLANGES WITH
STAINLESS STEEL. THIS WORK WAS DONE DURING PUMP OVERHAUL ON WO 1374. JH

COMPLETION DATE: 06/28/96
WORK ORDER COMPLETED BY: BB

-----END OF CURRENT WORK ORDER-----

ARTICLE 1 PARALLEL OPERATION..... 3
ARTICLE 2 PURCHASE AND SALE OF ENERGY AND DISPATCHABILITY; RATE
FOR PURCHASE AND SALE; BILLING AND PAYMENT..... 4
ARTICLE 3 FACILITY OWNED AND/OR OPERATED BY SELLER..... 22
ARTICLE 4 COMPANY-OWNED INTERCONNECTION FACILITIES..... 28
ARTICLE 5 MAINTENANCE RECORDS AND SCHEDULING..... 29
ARTICLE 6 FORECASTING..... 33
ARTICLE 7 SELLER PAYMENTS..... 37
ARTICLE 8 COMPANY DISPATCH..... 38
ARTICLE 9 PERSONNEL AND SYSTEM SAFETY..... 40
ARTICLE 10 METERING..... 41
ARTICLE 11 GOVERNMENT APPROVALS, LAND RIGHTS AND COMPLIANCE
WITH LAWS..... 43
ARTICLE 12 TERM OF AGREEMENT AND COMPANY'S OPTION TO PURCHASE
AT END OF TERM..... 44
ARTICLE 13 GUARANTEED PROJECT MILESTONES INCLUDING COMMERCIAL
OPERATIONS..... 50
ARTICLE 14 CREDIT ASSURANCE AND SECURITY..... 55
ARTICLE 15 EVENTS OF DEFAULT..... 59
ARTICLE 16 DAMAGES IN THE EVENT OF TERMINATION BY COMPANY..... 65
ARTICLE 17 INDEMNIFICATION..... 67
ARTICLE 18 INSURANCE..... 71
ARTICLE 19 TRANSFERS, ASSIGNMENTS, AND FACILITY DEBT..... 74
ARTICLE 20 SALE OF ENERGY TO THIRD PARTIES..... 77
ARTICLE 21 FORCE MAJEURE..... 78
ARTICLE 22 WARRANTIES AND REPRESENTATIONS..... 83
ARTICLE 23 PROCESS FOR ADDRESSING REVISIONS TO PERFORMANCE
STANDARDS..... 85
ARTICLE 24 FINANCIAL COMPLIANCE..... 91
ARTICLE 25 GOOD ENGINEERING AND OPERATING PRACTICES..... 96
ARTICLE 26 EQUAL EMPLOYMENT OPPORTUNITY..... 97
ARTICLE 27 SET OFF..... 98
ARTICLE 28 DISPUTE RESOLUTION..... 99
ARTICLE 29 MISCELLANEOUS..... 101
SCHEDULE OF DEFINED TERMS..... SCHEDULE-1
ATTACHMENT A DESCRIPTION OF GENERATION AND CONVERSION FACILITY... A-1
ATTACHMENT B FACILITY OWNED BY SELLER..... B-1
ATTACHMENT C METHODS AND FORMULAS FOR MEASURING PERFORMANCE
STANDARDS..... C-1
ATTACHMENT D CONSULTANTS LIST..... D-1
ATTACHMENT E SINGLE-LINE DRAWING AND INTERFACE BLOCK DIAGRAM.... E-1
ATTACHMENT F RELAY LIST AND TRIP SCHEME..... F-1
ATTACHMENT G COMPANY-OWNED INTERCONNECTION FACILITIES..... G-1
ATTACHMENT H BILL OF SALE AND ASSIGNMENT..... H-1
ATTACHMENT I ASSIGNMENT OF LEASE AND ASSUMPTION..... I-1
ATTACHMENT J COMPANY PAYMENTS FOR ENERGY AND DISPATCHABILITY.... J-1

ATTACHMENT K GUARANTEED PROJECT MILESTONES..... K-1
ATTACHMENT L REPORTING MILESTONES..... L-1
ATTACHMENT M FORM OF LETTER OF CREDIT..... M-1
ATTACHMENT N ACCEPTANCE TEST GENERAL CRITERIA..... N-1
ATTACHMENT O CONTROL SYSTEM ACCEPTANCE TEST CRITERIA..... O-1
ATTACHMENT P SALE OF FACILITY BY SELLER..... P-1
ATTACHMENT Q [RESERVED]..... Q-1
ATTACHMENT R REQUIRED INSURANCE..... R-1
ATTACHMENT S FORM OF MONTHLY PROGRESS REPORT..... S-1
ATTACHMENT T MONTHLY REPORTING AND DISPUTE RESOLUTION BY
INDEPENDENT AF EVALUATOR.....T-1
ATTACHMENT U CALCULATION AND ADJUSTMENT OF NET ENERGY POTENTIAL..U-1
ATTACHMENT V SUMMARY OF MAINTENANCE & INSPECTION PERFORMED IN
PRIOR CALENDAR YEAR.....V-1

DRAFT REQUEST FOR PROPOSALS
FOR
VARIABLE RENEWABLE DISPATCHABLE GENERATION

ISLAND OF O‘AHU

FEBRUARY 2, 2018

Docket No. 2017-0352

Appendix C2 – Model Wind RDG PPA



**Hawaiian
Electric**

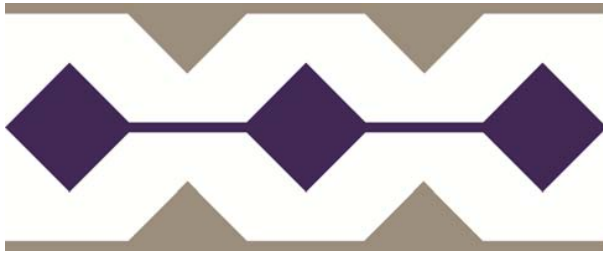

**Hawaiian
Electric**

Model
Power Purchase Agreement
For
Renewable Dispatchable Generation
(Wind)

February 2018

Drafting Note: This document has been prepared for Hawaiian Electric Company, Inc. projects. It will be adapted for use for by Hawaii Electric Light Company Inc. and Maui Electric Company, Limited by (1) changing the entity designated as "the Company," (2) modifying the Company's address for notices at Section 29.3(a), (3) modifying the Hawaii general excise tax rate at Section 29.24, (4) revising the Company's signature Block and (5) substituting the form of Attachment B (Facility Owned Seller) appropriate to the designated Company entity. For Maui Electric, if the project is located at Maui Electric's Waena site, the PPA will be cross-defaulted to the ground lease. For Hawaii Electric Light, the forms of Attachment N (Acceptance Test General Criteria) and Attachment O (Control System Acceptance Test Criteria) will also be modified, as will the defined terms to the extent necessary to conform to Hawaii Electric Light's Attachments B, N and O.

This document indicates, for information purposes only, the terms and conditions that may be negotiated in a contract for the sale of renewable dispatchable generation to be executed by Hawaiian Electric. The terms and conditions that may be offered by Hawaiian Electric in a renewable dispatchable generation power purchase agreement may be modified to reflect factors such as different renewable technologies, project specifics, changes in applicable rules, guidance from the Public Utilities Commission in proceedings concerning the approval or negotiation of such power purchase agreements, results of an interconnection requirements study and other negotiated terms and conditions.

[NOTE: TEXT WITHIN THIS DOCUMENT THAT APPEARS IN BOLD AND/OR BRACKETS INDICATES A PROVISION THAT MAY REQUIRE REVISION TO CONFORM TO A SPECIFIC PROJECT.]

POWER PURCHASE AGREEMENT FOR RENEWABLE DISPATCHABLE GENERATION)

THIS POWER PURCHASE AGREEMENT FOR RENEWABLE DISPATCHABLE GENERATION ("Agreement") is made this ____ day of _____, 20__ (the "Execution Date"), by and between **Hawaiian Electric Company, Inc.**, a Hawai'i corporation (hereinafter called the "Company") and _____ (hereinafter called the "Seller").

WHEREAS, Company is an operating electric public utility on the Island of O'ahu, subject to the Hawai'i Public Utilities Law (Hawai'i Revised Statutes, Chapter 269) and the rules and regulations of the Hawai'i Public Utilities Commission (hereinafter called the "PUC"); and

WHEREAS, the Company System is operated as an independent power grid and must both maximize system reliability for its customers by ensuring that sufficient generation is available and meet the requirements for voltage stability, frequency stability, and reliability standards; and

WHEREAS, Company desires to minimize fluctuations in its purchased energy costs by acquiring renewable dispatchable generation at a fixed Unit Price; and

WHEREAS, Seller desires to build, own, and operate a renewable energy facility that is classified as an eligible resource under Hawai'i's Renewable Portfolio Standards Statute (codified as Hawai'i Revised Statutes (HRS) 269-91 through 269-95); and

WHEREAS, Seller understands the need to use all commercially reasonable efforts to maximize the overall reliability of the Company System; and

WHEREAS, Facility will be located at _____, State of Hawai'i and is more fully described in Attachment A (Description of Generation and Conversion Facility) and Attachment B (Facility Owned by Seller) attached hereto and made a part hereof; and

WHEREAS, Seller desires to sell to Company, and Company agrees to purchase upon the terms and conditions set forth herein, (i) the electric energy generated by the Facility and (ii) the availability, at a fixed Unit Price for the duration of the Initial Term, of the Facility's Net Energy Potential to respond, subject to the Renewable Resource Variability, to Company's dispatch.

NOW, THEREFORE, in consideration of the premises and the respective promises herein, Company and Seller hereby agree as follows:

DEFINITIONS

When the capitalized terms set forth in the Schedule of Defined Terms are used in this Agreement, such terms shall have the meanings set forth in such Schedule.

ARTICLE 1
PARALLEL OPERATION

Company agrees to allow Seller to interconnect and operate the Facility to provide renewable dispatchable generation and energy in parallel with the Company System; provided, however, that such interconnection and operation shall not: (i) adversely affect Company's property or the operations of its customers and customers' property; (ii) present safety hazards to the Company System, Company's property or employees or Company's customers or the customers' property or employees; or (iii) otherwise fail to comply with this Agreement. Such parallel operation shall be contingent upon the satisfactory completion, as determined solely by Company, of the Acceptance Test and, to the extent applicable, the Control System Acceptance Test, in accordance with Good Engineering and Operating Practices.

ARTICLE 2
PURCHASE AND SALE OF ENERGY AND DISPATCHABILITY;
RATE FOR PURCHASE AND SALE; BILLING AND PAYMENT

- 2.1 Purchase and Sale of Electric Energy and Dispatchability of Facility. Subject to the other provisions of this Agreement: (i) Company shall, by an Energy Payment, pay for the Actual Output produced by the Facility and delivered to the Point of Interconnection in response to Company Dispatch of the Facility; and (ii) Company shall, by a Lump Sum Payment, pay for the availability of the Facility's Net Energy Potential to respond, subject to the Renewable Resource Variability, to Company Dispatch in accordance with this Agreement. Included in such purchase and sale of electric energy and such purchase and sale of dispatchability are all of the Environmental Credits associated with the electric energy. Company will not reimburse Seller for any taxes or fees imposed on Seller including, but not limited to, State of Hawai'i general excise tax.
- 2.2 Payment for Electric Energy. Commencing on the Commercial Operations Date, in exchange for the electric energy delivered to the Point of Interconnection in response to Company Dispatch, Seller will be paid an Energy Payment on a monthly basis as provided in Section 1 (Price for Purchase of Electric Energy) of Attachment J (Company Payments for Energy and Dispatchability) to this Agreement.
- 2.3 Lump Sum Payment for Dispatchability. Commencing on the Commercial Operations Date, in exchange for the availability of the Facility's Net Energy Potential to respond, subject to the Renewable Resource Variability, to Company's dispatch in accordance with this Agreement, Company shall pay to Seller a monthly Lump Sum Payment as provided in Section 2 (Lump Sum Payment for Dispatchability) of Attachment J (Company Payments for Energy and Dispatchability) to this Agreement. As more fully set forth in Section 3 (Calculation of Lump Sum Payment) of said Attachment J, the monthly Lump Sum Payment shall be calculated and adjusted to reflect changes in the estimate of the Facility's Net Energy Potential as such estimate is revised from time to time as more fully set forth in Attachment U (Calculation and Adjustment of Net Energy Potential) to this Agreement. For purposes of calculating the monthly Lump Sum Payment to be made to Seller for making the Facility's Net Energy Potential available for Company Dispatch, the monthly Lump

Payment shall be adjusted downward to account for WTGS(s) that are not available for Company Dispatch because of a Force Majeure condition (i) at the Facility or (ii) that otherwise delays or prevents the Seller from making the WTGS(s) in question available for Company Dispatch, as more fully set forth in Section 3.iv of Attachment J (Company Payments for Energy and Dispatchability) to this Agreement.

2.4 Assurance of Capability of Facility to Deliver Net Energy Potential.

- (a) Design, Operation and Maintenance to Achieve PBAF Benchmark and BOP Benchmark. In order to provide Company with reasonable assurance that, subject to the Renewable Resource Variability, the Facility's Net Energy Potential will be available for Company Dispatch: (i) the Facility PBAF shall be used to evaluate the availability of the Facility for dispatch by Company and (ii) the BOP Efficiency Ratio shall be used to evaluate the capability of the Facility to deliver to the Point of Interconnection, without unreasonable reduction due to electrical losses, the electric energy produced by the WTGS(s). Seller shall design, operate and maintain the Facility in a manner consistent with the standard of care reasonably expected of an experienced owner/operator with the desire and financial resources necessary to design, operate and maintain the Facility to achieve the PBAF Benchmark and the BOP Benchmark. The foregoing is without limitation to Seller's other obligations under this Agreement, including the obligation to operate the Facility in accordance with Good Engineering and Operating Practices.
- (b) Acknowledgment of Uncertainties. The Parties acknowledge the inherent uncertainty in the measurement of the Applicable Power Curve and the calculation of Potential Production, both of which are necessary to the calculation of the Facility PBAF. The Parties also acknowledge the inherent uncertainty in the calculation of the efficiency of the BOP in delivering to the Point of Interconnection the energy produced by the WTGS(s). Both Parties hereby assume the risk of such uncertainties and hereby waive any right to dispute:
- (i) the appropriateness of any of the Facility PBAF, the PBAF Benchmark or the methodology specified in this Agreement for the determination of the

Applicable Power Curve, Potential Production, Actual Production, Lost Production and the Facility PBAF; and

- (ii) the appropriateness of any of the BOP Benchmark, the BOP Efficiency Ratio or the methodology specified in this Agreement for the determination of the BOP Benchmark or the BOP Efficiency Ratio.

2.5 Facility PBAF; Liquidated Damages; Termination Rights.

- (a) Calculation of Facility PBAF. Following the end of each PBAF LD Period, Company shall calculate the Facility PBAF for such PBAF LD Period as follows:

$$\text{Facility PBAF} = 1 - \frac{\text{Facility Lost Production}}{\text{Facility Full Dispatch Production} + \text{Facility Lost Production}}$$

Facility Lost Production and Facility Actual Production shall be calculated as provided in Section 4 of (Population of Information Categories of Modified Information Model) of Attachment T (Calculation and Reporting of Production Based Availability and Dispute Resolution by Independent Evaluator of Production-Based Availability) to this Agreement.

- (b) PBAF Benchmark and Liquidated Damages. For each PBAF LD Period, Seller shall achieve a Facility PBAF, as calculated as provided in Section 2.5(a) (Calculation of Facility PBAF) of this Agreement, of not less than the PBAF Benchmark. If the PBAF for a PBAF LD Period is less than the PBAF Benchmark, Seller shall pay, and Company shall accept, as liquidated damages for Seller's failure to achieve the PBAF Benchmark for such PBAF LD Period, an amount calculated in accordance with the following formula:

<u>Facility PBAF</u>	<u>Amount of Liquidated Damages Per Calendar Month</u>
----------------------	--

94.9% to 90%	For each one-tenth of one percent (0.001) by which the Facility PBAF for such PBAF LD Period falls below the PBAF Benchmark up to and including a Facility PBAF of 90% , an amount equal to one-tenth of one
---------------------	---

percent (0.001) of the Applicable Period Lump Sum Payment for such calendar month; plus

89.9% to 80% For each one-tenth of one percent (0.001) by which the Facility PBAF for such PBAF LD Period falls below **90%** up to and including a Facility PBAF of **80%**, an amount equal to two-tenths of one percent (0.002) of the Applicable Period Lump Sum Payment for such calendar month; plus

79.9% and below For each one-tenth of one percent (0.001) by which the Facility PBAF for such PBAF LD Period falls below **80%**, an amount equal to four-tenths of one percent (0.004) of the Applicable Period Lump Sum Payment for such calendar month.

For purposes of determining liquidated damages under the preceding formula, the amount by which the Facility PBAF for the PBAF LD Period in question falls below the applicable threshold shall be rounded to the nearest one-tenth of one percent (0.001). For avoidance of doubt, because the PBAF is calculated over a PBAF LD Period of 12 calendar months, the first month for which liquidated damages may be assessed under this Section 2.5(b) (Facility PBAF; Liquidated Damages; Termination Rights) would be the last calendar month of the initial Contract Year. Each Party agrees and acknowledges that (i) the damages that Company would incur if the Seller fails to achieve the PBAF Benchmark for a PBAF LD Period would be difficult or impossible to calculate with certainty and (ii) the aforesaid liquidated damages are an appropriate approximation of such damages.

- (c) Payment of Liquidated Damages for Failure to Achieve the PBAF Benchmark. With respect to the liquidated damages for a calendar month payable under Section 2.5(b) (PBAF Benchmark and Liquidated Damages), Company shall have the right, at any time on or after the PBAF LD Assessment Date for such liquidated damages, at Company's option, to off-set such liquidated damages from the amounts to be paid to Seller under Section 2.3

(Lump Sum Payment for Dispatchability) of this Agreement or to draw such liquidated damages from the Operating Period Security, as follows:

- (i) if the PBA Report for a given calendar month shows a Facility PBAF for the PBAF LD Period in question for which liquidated damages are payable under Section 2.5(b) (PBAF Benchmark and Liquidated Damages) and Company does not submit a Notice of PBA Disagreement with respect to such PBA Report, the Company shall have the right to off-set or draw the amount of liquidated damages for such calendar month as calculated on the basis of such Facility PBAF; and
- (ii) in all cases in which Company submits a Notice of Disagreement for a given PBA Report, Company shall have the right to off-set or draw all or any portion of the amount of liquidated damages for calendar month in question as calculated on the basis of the Facility PBAF for the PBAF LD Period in question, as shown in such Notice of Disagreement; provided, however, that:
 - (aa) if the amount off-set or drawn by the Company exceeds the amount of liquidated damages for such calendar month that are eventually found to be payable pursuant to the Facility PBAF for the PBAF LD Period in question as determined under either Section 7(e) (Submission of PBA Disagreement to Independent PBA Evaluator) or Section 7(j) (Written Decision of Independent PBA Evaluator) of Attachment T (Calculation and Reporting of Production-Based Availability and Dispute Resolution by Independent PBA Evaluator) to this Agreement, Company shall promptly repay such excess to Seller together with, unless the Parties otherwise agree in writing, interest from the date of Company's off-set or draw until the date that such excess is repaid to Seller at the average Prime Rate for such period; and
 - (bb) if Company does not exercise its rights to set-off or draw liquidated damages for such

calendar month, or does not set-off or draw the full amount of the liquidated damages for such calendar month that are eventually found to be payable pursuant to the determination of the Facility PBAF for the PBAF LD Period in question as determined under either Section 7(e) (Submission of PBA Disagreement to Independent PBA Evaluator) or Section 7(j) (Written Decision of Independent PBA Evaluator) of Attachment T (Calculation and Reporting of Production-Based Availability and Dispute Resolution by Independent PBA Evaluator) to this Agreement, Seller shall promptly, upon determination of such Facility PBAF as aforesaid, pay to Company the amount of liquidated damages that are found to be owing together with, unless otherwise agreed by the Parties in writing, interest on the amount of such liquidated damages that went unpaid from the PBAF LD Assessment Date for such liquidated damages until the date such liquidated damages are paid to Company in full at the average Prime Rate for such period, and Company shall have the right, at its option, to off-set such interest for the amounts to be paid to Seller under Section 2.3 (Lump Sum Payment for Dispatchability) of this Agreement or to draw from the Operating Period Security.

Any delay by Company in exercising its rights to off-set liquidated damages and/or interest from the amounts to be paid to Seller under Section 2.3 (Lump Sum Payment for Dispatchability) of this Agreement or to draw such liquidated damages and/or interest from the Operating Period Security shall not constitute a waiver by Company of its right to do so.

- (d) Facility PBAF Termination Rights. The Parties acknowledge that, although the intent of the liquidated damages payable under Section 2.5(b) (PBAF Benchmark and Liquidated Damages) is to compensate Company for the damages that Company would incur if the Seller fails to achieve the PBAF Benchmark for a PBAF LD Period, such liquidated damages are not intended to compensate Company for the damages that Company would incur if a pattern of underperformance establishes a reasonable

expectation that the Facility is likely to continue to substantially underperform the PBAF Benchmark. Accordingly, and without limitation to Company's rights under said Section 2.5(b) (PBAF Benchmark and Liquidated Damages) for those PBAF LD Periods during which the Seller failed to achieve the PBAF Benchmark, the failure of the Facility to achieve a Facility PBAF of not less than **80%** for each of three consecutive Contract Years shall constitute an Event of Default under Section 15.1(b) of this Agreement for which Company shall have the rights (including but not limited to the termination rights) set forth in Article 15 (Event of Default) and Article 16 (Damages in the Event of Termination by Company).

2.6 BOP Efficiency Ratio; Liquidated Damages; Termination Rights.

- (a) Calculation of Annual BOP Efficiency Ratio. Following the end of each Contract Year, Company shall calculate the BOP Efficiency Ratio for such Contract Year as follows:

$$\text{BOP Efficiency Ratio} = \frac{\text{Actual Output for such Contract Year}}{\text{Facility Actual Production for such Contract Year}}$$

- (b) Determination of BOP Benchmark.

- (i) First Two Contract Years. If a copy of the IE Energy Assessment Report is not provided to Company, the BOP Benchmark for the first two Contract Years shall be **97%**. If a copy of the IE Energy Assessment Report is provided to Company, the BOP Benchmark shall be derived from the IE Energy Assessment Report on the basis of the estimated electrical losses for the BOP used in the IE Energy Assessment Report in arriving at the NEP IE Estimate. Within 30 Days of Company's receipt of the IE Energy Assessment Report, Company shall provide written notice to Seller of either (aa) the BOP Benchmark derived from the IE Energy Assessment Report or (bb) Company's inability to reasonably derive a BOP Benchmark from the IE Energy Assessment, in which case the BOP Benchmark shall

be **97%**.

- (ii) Commencing With Third Contract Year. For the third Contract Year through the end of the Contract Year preceding the Contract Year during which the first Subsequent OEPR is issued, the BOP Benchmark shall be derived from the Initial OEPR on the basis of the estimated electrical losses for the BOP used in the Initial OEPR in arriving at the Initial OEPR's NEP OEPR Estimate. Within 30 Days of Company's receipt of the Initial OEPR, Company shall either (i) provide written notice to Seller of the BOP Benchmark derived from the Initial OEPR or (ii) if Company is unable to reasonably derive a BOP Benchmark from the Initial OEPR, deliver a written request to the OEPR Evaluator (with a copy to Seller) that such OEPR Evaluator issue, within 30 Days, a written clarification of the Initial OEPR specifying the BOP Benchmark. If such request for clarification is made to the OEPR Evaluator, within 10 Business Days following the expiration of the 30-Day period provided for receipt of such OEPR Evaluator's reply, Company shall provide written notice to Seller of either (i) the BOP Benchmark derived from such written clarification by the OEPR Evaluator or (ii) the designation of **97%** as the BOP Benchmark due to either the failure of the OEPR Evaluator to issue a written clarification or, if a written clarification was issued, the inability of Company to reasonably derive a BOP Benchmark on the basis of such written clarification.
- (iii) Commencing With the First Subsequent OEPR and Thereafter. For any Contract Year during which a Subsequent OEPR is issued through the end of the Contract Year preceding the Contract Year during which the next Subsequent OEPR is issued, the BOP Benchmark shall be derived from the first of the two Subsequent OEPRs referenced in this sentence on the basis of the estimated electrical losses for the BOP used in such Subsequent OEPR in arriving at such Subsequent OEPR's NEP Estimate. Within 30 Days of Company's receipt of such Subsequent OEPR, Company shall either (i) provide written notice to Seller of the BOP Benchmark derived from such Subsequent OEPR or (ii) if Company's is unable to

reasonably derive a BOP Benchmark from such Subsequent OEPR, deliver a written request to the OEPR Evaluator (with a copy to Seller) that such OEPR Evaluator issue, within 30 Days, a written clarification of such Subsequent OEPR specifying the BOP Benchmark. If such request for clarification is made to the OEPR Evaluator, within 10 Business Days following the expiration of the 30-Day period provided for the receipt of such OEPR Evaluator reply, Company shall provide written notice to Seller of either (i) the BOP Benchmark derived from such written clarification by the OEPR Evaluator or (ii) the designation of **97%** as the BOP Benchmark due to either the failure of the OEPR Evaluator to issue a written clarification or, if a written clarification was issued, the inability of Company to reasonably derive a BOP Benchmark on the basis of such written clarification.

(iv) Disagreement Over Determination of BOP Benchmark. Any disagreement over the determination of the BOP Benchmark shall be resolved as set forth in Section 7 (Disagreements Concerning Historical Power Curve, Production-Based Availability and BOP Benchmark) of Attachment T (Calculation and Reporting of Production-Based Availability and Dispute Resolution by PBA Evaluator) to this Agreement.

(c) BOP Benchmark and Liquidated Damages. For each Contract Year, Seller shall achieve a BOP Efficiency Ratio, as calculated as provided in Section 2.6(a) (Calculation of Annual BOP Efficiency Ratio) of this Agreement, of not less than the BOP Benchmark. If the BOP Efficiency Ratio for a Contract Year is less than the BOP Benchmark, Seller shall pay, and Company shall accept, as liquidated damages for Seller's failure to achieve the BOP Benchmark for such Contract Year, an amount calculated in accordance with the following formula:

Amount of Liquidated Damages Per
Contract Year

For each one-tenth of one percent (0.001) by which the BOP Efficiency

Ratio for such Contract Year falls below the BOP Benchmark up to and including a BOP Efficiency Ratio of three percentage points below the BOP Benchmark ("BOP Benchmark Minus 3"), one-tenth of one percent (0.001) of the Applicable Period Lump Sum Payment for such Contract Year; plus

For each one-tenth of one percent (0.001) by which the BOP Efficiency Ratio for such Contract Year falls below BOP Benchmark Minus 3 up to and including a BOP Efficiency Ratio of six percentage points below the BOP Benchmark ("BOP Benchmark Minus 6", two-tenths of one percent (0.002) of the Applicable Period Lump Sum Payment for such Contract Year; plus

For each one-tenth of one percent (0.001) by which the BOP Efficiency Ratio for such Contract Year falls below BOP Benchmark Minus 6, four-tenths of one percent (0.004) of the Applicable Period Lump Sum Payment for such Contract Year.

For purposes of determining liquidated damages under the preceding formula, the amount by which the BOP Efficiency Ratio for the Contract Year in question falls below the applicable threshold shall be rounded to the nearest one-tenth of one percent (0.001). Each Party agrees and acknowledges that (i) the damages that Company would incur if the Seller fails to achieve the BOP Benchmark for a Contract Year would be difficult or impossible to calculate with certainty and (ii) the aforesaid liquidated damages are an appropriate approximation of such damages.

- (d) Payment of Liquidated Damages for Failure to Achieve BOP Benchmark. For each Contract Year for which liquidated damages are payable under Section 2.6(c) (BOP Benchmark and Liquidated Damages), Company shall, within 30 Days following the end of such Contract Year, issue to Seller a BOP LD Assessment Notice setting forth the BOP Benchmark, the BOP Efficiency Ratio and the calculation

of the liquidated damages. Company shall have the right, at any time on or after the BOP LD Assessment Date for such liquidated damages, at Company's option, to off-set such liquidated damages from the amounts to be paid to Seller under Section 2.3 (Lump Sum Payment for Dispatchable Availability) of this Agreement or to draw from the Operating Period Security as follows:

- (i) if the BOP Benchmark used in the calculation of such liquidated damages is not then subject to an unresolved BOP Benchmark Disagreement, the Company shall have the right to off-set or draw the amount of liquidated damages for such Contract Year set forth in such BOP LD Assessment Notice; and
- (ii) if the BOP Benchmark used in the calculation of such liquidated damages is then subject to an unresolved BOP Benchmark Disagreement, Company shall have the right to off-set or draw all or any portion of the liquidated damages set forth in such BOP LD Assessment Notice; provided, however, that:
 - (aa) if the amount off-set or drawn by the Company exceeds the amount of liquidated damages for such Contract Year that are eventually determined to be payable for such Contract Year once the BOP Benchmark Disagreement is resolved pursuant to either Section 7(f) (Submission of BOP Benchmark Disagreement to Independent PBA Evaluator) or Section 7(j) (Written Decision of Independent PBA Evaluator) of Attachment T (Calculation and Reporting of Production-Based Availability and Dispute Resolution by Independent PBA Evaluator) to this Agreement, Company shall promptly repay such excess to Seller together with, unless the Parties otherwise agree in writing, interest from the date of Company's off-set or draw until the date such excess is repaid to Seller at the average Prime Rate for such period; and
 - (bb) if Company does not exercise its rights to set-off or draw liquidated damages for such Contract year, or does not set-off or draw the full amount of the liquidated damages for such Contract Year that are eventually determined to be payable on the basis of the BOP Benchmark that is determined pursuant to

either Section 7(f) (Submission of BOP Benchmark Disagreement to Independent PBA Evaluator) or Section 7(j) (Written Decision of Independent PBA Evaluator) of Attachment T (Calculation and Reporting of Production-Based Availability and Dispute Resolution by Independent PBA Evaluator) to this Agreement, Seller shall promptly, upon the determination of such BOP Benchmark as aforesaid, pay to Company the amount of liquidated damages that are then determined to be owing together with, unless otherwise agreed by the Parties in writing, interest on the amount of such liquidated damages that went unpaid from the BOP LD Assessment Date for such liquidated damages until the date such liquidated damages are paid to Company in full at the average Prime Rate for such period, and Company shall have the right, at its option, to off-set such interest from the amounts to be paid to Seller under Section 2.3 (Lump Sum Payment for Dispatchability) of this Agreement or to draw from the Operating Period Security.

Any delay by Company in exercising its rights to off-set liquidated damages and/or interest from the amounts to be paid to Seller under Section 2.3 (Lump Sum Payment for Dispatchability) of this Agreement or to draw such liquidated damages and/or interest from the Operating Period Security shall not constitute a waiver by Company of its right to do so.

- (e) BOP Efficiency Ratio Termination Rights. The Parties acknowledge that, although the intent of the liquidated damages payable under Section 2.6(c) (BOP Benchmark and Liquidated Damages) is to compensate Company for the damages that Company would incur if Seller fails to achieve the BOP Benchmark for a Contract Year, such liquidated damages are not intended to compensate Company for the damages that Company would incur if a pattern of underperformance establishes a reasonable expectation that the Facility is likely to continue to substantially underperform the BOP Benchmark. Accordingly, and without limitation to Company's rights under said Section 2.6(c) (BOP Benchmark and Liquidated Damages) for those Contract Years during which the Seller failed to achieve the BOP Benchmark, the failure of the Facility to achieve a BOP Efficiency Ratio of not

less than BOP Benchmark Minus 6 for each of three consecutive Contract Years shall constitute an Event of Default under Section 15.1(c) of this Agreement for which Company shall have the rights (including but not limited to the termination rights) set forth in Article 15 (Events of Default) and Article 16 (Damages in the Event of Termination by Company).

- 2.7 No Payments Prior to Commercial Operations Date. Prior to the Commercial Operations Date, Company shall not be obligated to accept or pay for any electric energy delivered by Seller. Company shall not, and shall not be obligated to, make any payment for the availability of the Facility prior to the Commercial Operations Date.
- 2.8 Sales of Electric Energy By Company to Seller. Sales of electric energy by Company to Seller shall be governed by an applicable rate schedule filed with the PUC and not by this Agreement, except with respect to the reactive amount adjustment (if any) referred to in Attachment B (Facility Owned by Seller).
- 2.9 Company's Obligation to Provide Certain Data. By the fifth (5th) Business Day of each calendar month, Company shall provide Seller or its designated agent with the appropriate data for Seller to compute the amount to be paid for the electric energy purchased by Company in the preceding calendar month as determined in accordance with this Agreement.
- 2.10 Seller's Preparation of the Monthly Invoice. By the tenth (10th) Business Day of each calendar month, Seller shall submit to Company an invoice that separately states the following for the preceding month: (i) the Actual Output during this period; (ii) the charge for electric energy purchased by Company, as set forth in Attachment J (Company Payments for Energy and Dispatchability) of this Agreement; (iii) the monthly Lump Sum Payment for this period; and (iv) the monthly metering charge as set forth in Article 7 (Seller Payments) of this Agreement.
- 2.11 Payment Procedures. By the twentieth (20th) Business Day of each calendar month (but, except as otherwise provided in the following sentence, no later than the last Business Day of that month if there are less than twenty Business Days in that month), Company shall, subject to Company's right to off-set liquidated damages as provided in Section 2.5(c)

(Payment of Liquidated Damages for Failure to Achieve the PBAF Benchmark) and Section 2.6(d) (Payment of Liquidated Damages for Failure to Achieve the BOP Benchmark) of this Agreement, make payment on such invoice, or provide to Seller an itemized statement of its objections to all or any portion of such invoice and pay any undisputed amount. Notwithstanding the foregoing, the Day by which the Company shall make payment to Seller hereunder shall be increased by one (1) day for each Day that Seller is delinquent in providing to the Company either: (i) the PBA Report for the calendar month in question pursuant to Section 6 (PBA Report) of Attachment T (Calculation and Reporting of Production-Based Availability and Dispute Resolution by Independent PBA Evaluator) to this Agreement; or (ii) the information required under Section 2.10 (Seller's Preparation of the Monthly Invoice) of this Agreement. However, if Company is not timely in providing data required in Section 2.9 (Company's Obligation to Provide Certain Data) and this directly causes Seller to be unable to deliver its invoice in accordance with the time frame set forth in Section 2.10 (Seller's Preparation of the Monthly Invoice), then Company shall still meet the twentieth (20th) Business Day payment date. If Seller is unable to provide a complete invoice for the reasons set forth in the preceding sentence, an estimated payment, subject to reconciliation with the complete invoice, may be made by Company as an interim provision until a complete invoice can be prepared by Seller and received by Company.

- 2.12 Late Payments. Notwithstanding all or any portion of such invoice in dispute, and subject to the provisions of Section 2.5(c)(ii) and Section 2.6(d)(ii) of this Agreement (to the extent applicable), interest shall accrue on any invoiced amount that remains unpaid following the twentieth (20th) Business Day of each calendar month (or the last Business Day of that month if there are less than twenty Business Days in that month), or following the due date for such payment if extended pursuant to Section 2.11 (Payment Procedures), at the average daily Prime Rate for the period commencing on the Day following the Day such payment is due such until the invoiced amounts (or amounts due to Seller if determined to be less than the invoiced amounts) are paid in full. Partial payments shall be applied first to outstanding interest and then to outstanding invoice amounts.

- 2.13 Adjustments to Invoices After Payment. In the event adjustments are required to correct inaccuracies in an invoice after payment, the Party requesting adjustment shall recompute and include in the Party's request the principal amounts due during the period of the inaccuracy together with the amount of interest from the date that such invoice was payable until the date that such recomputed amount is paid at the average daily Prime Rate for the period. The difference between the amount paid and that recomputed for the invoice, along with the allowable amount of interest, shall either be (i) paid to Seller or set-off by Company, as appropriate, in the next invoice payment to Seller, or (ii) objected to by the Party responsible for such payment within thirty (30) Days following its receipt of such request. If the Party responsible for such payment objects to the request, then the Parties shall work together in good faith to resolve the objection. If the Parties are unable to resolve the objection, the matter shall, except to the extent otherwise provided in Section 28.3 (Exclusions), be resolved pursuant to Article 28 (Dispute Resolution). All claims for adjustments shall be waived for any amounts that were paid or should have been payable more than thirty-six (36) months preceding the date of receipt of any such request.
- 2.14 Company's Billing Records. Seller, after giving reasonable advance written notice to Company, shall have the right to review all billing, metering and related records necessary to verify the accuracy of the data provided by Company pursuant to Section 2.9 (Company's Obligation to Provide Certain Data) and payments relating to the Facility during Company's normal working hours on Business Days. Company shall maintain such records for a period of not less than thirty-six (36) months.

ARTICLE 3
FACILITY OWNED AND/OR OPERATED BY SELLER

- 3.1 The Facility. Seller agrees to furnish, install, operate, and maintain the Facility in accordance with the provisions of this Agreement, including, without limitation, the operating procedures and performance standards as more fully described in Attachment B (Facility Owned by Seller) and Attachment C (Methods and Formulas for Measuring Performance Standards). After the Commercial Operations Date, Seller agrees that no changes or additions to the Facility shall be made without prior written approval by Company and amendment to the Agreement unless such changes or additions to the Facility could not reasonably be expected to have a material effect on the assumptions used in performing the IRS.
- 3.2 Allowed Capacity. The net instantaneous MW output from Facility may not exceed the Allowed Capacity. Company may take appropriate action to limit the Actual Output pursuant to, but not limited to, Article 8 (Company Dispatch), Article 9 (Personnel and System Safety), Article 25 (Good Engineering and Operating Practices), and Attachment B (Facility Owned by Seller).
- 3.3 Point of Interconnection. The Point of Interconnection is shown on Attachment E (Single-Line Drawing and Interface Block Diagram), as provided in Section 1(a)(i) (Single-Line Drawing, Interface Block Diagram, Relay List, Relay Settings and Trip Scheme) of Attachment B (Facility Owned by Seller). The Point of Interconnection will be at the voltage level of the Company System. If it is necessary to step up the voltage at which Seller's electric energy is delivered to Company System, the Point of Interconnection will be on the high voltage side of the step-up transformer.
- 3.4 Renewable Portfolio Standards.
- (a) Renewable Portfolio Standards. If, as a result of any RPS Amendment, the electric energy delivered from the Facility should no longer qualify as "renewable electrical energy," Seller shall, at the request of Company, develop and recommend to Company within a reasonable period of time following Company's request, but in no event more than 90 Days after Seller's receipt of such request (or such other period of time as Company and Seller may agree in writing) reasonable measures to cause the electric energy delivered from

the Facility to come within such revised definition of "renewable electrical energy" ("Seller's RPS Modifications Proposal").

- (b) Seller's RPS Modifications Proposal. Upon receipt of Seller's RPS Modifications Proposal, Company will evaluate Seller's RPS Modifications Proposal. Seller shall assist Company in performing such evaluation as and to the extent reasonably requested by Company (including, but not limited to, providing such additional information as Company may reasonably request and participating in meetings with Company as Company may reasonably request).
- (c) RPS Modifications Document. If, following Company's evaluation of Seller's RPS Modifications Proposal, Company desires to consider the implementation by Seller of the changes recommended in Seller's RPS Modifications Proposal, Company shall provide Seller with written notice to that effect, such notice to be issued to Seller within 180 Days of receipt of Seller's RPS Modifications Proposal, and Company and Seller shall proceed to negotiate in good faith a document setting forth the specific changes to the Agreement that are necessary to implement such RPS Modifications Proposal (the "RPS Modifications Document"). A decision by Company to initiate negotiations with Seller as aforesaid shall not constitute an acceptance by Company of any of the details set forth in Seller's RPS Modifications Proposal, including but not limited to the RPS Modifications and the RPS Pricing Impact. Any adjustment to the Contract Pricing pursuant to such RPS Modifications Document shall be limited to the RPS Pricing Impact. The time periods set forth in such RPS Modifications Document as to the effective date for the RPS Modifications shall be measured from the date the PUC Order with respect to such RPS Modifications becomes non-appealable as provided in Section 3.4(e) (PUC RPS Order).
- (d) Failure to Reach Agreement. If Company and Seller are unable to agree upon and execute a RPS Modifications Document within 180 Days of Company's written notice to Seller pursuant to Section 3.4(c) (RPS Modifications Document), Company shall have the option of declaring the failure to reach agreement on and

execute such Document to be a dispute and submit such dispute to an Independent Evaluator for the conduct of a determination pursuant to Section 3.4(h) (Dispute) of this Agreement. Any decision of the Independent Evaluator, rendered as a result of such dispute shall include a form of a RPS Modifications Document as described in Section 3.4(c) (RPS Modifications Document).

- (e) PUC RPS Order. No RPS Modifications Document shall constitute an amendment to the Agreement unless and until a PUC RPS Order issued with respect to such Document has become non-appealable. Once the condition of the preceding sentence has been satisfied, such RPS Modifications Document shall constitute an amendment to this Agreement. To be "non-appealable" under this Section 3.4(e) (PUC RPS Order), such PUC RPS Order shall be either (i) not subject to appeal to any Circuit Court of the State of Hawai'i or the Supreme Court of the State of Hawai'i, because the thirty (30) Day period (accounting for weekends and holidays as appropriate) permitted for such an appeal has passed without the filing of notice of such an appeal, or (ii) affirmed on appeal to any Circuit Court of the State of Hawai'i or the Supreme Court, or the Intermediate Appellate Court upon assignment by the Supreme Court, of the State of Hawai'i, or affirmed upon further appeal or appellate process, and is not subject to further appeal, because the jurisdictional time permitted for such an appeal (and/or further appellate process such as a motion for reconsideration or an application for writ of certiorari) has passed without the filing of notice of such an appeal (or the filing for further appellate process).
- (f) Company's Rights. The rights granted to Company under Section 3.4(C) (RPS Modifications Document) and Section 3.4(D) (Failure to Reach Agreement) above are exclusive to Company. Seller shall not have a right to initiate negotiations of a RPS Modifications Document or to initiate dispute resolution under Section 3.4(H) (Dispute), as a result of a failure to agree upon and execute any RPS Modifications Document.
- (g) Limited Purpose. This Section 3.4 (Renewable Portfolio Standards) is intended to specifically

address the implementation of reasonable measures to cause the electric energy delivered from the Facility to come within the revised definition of "renewable electrical energy" under any RPS Amendment and is not intended for either Party to provide a means for renegotiating any other terms of this Agreement. Revisions to this Agreement in accordance with the provisions of this Section 3.4 (Renewable Portfolio Standards) are not intended to increase Seller's risk of non-performance or default.

- (h) Dispute. If Company decides to declare a dispute as a result of the failure to reach agreement and execute a RPS Modifications Document pursuant to Section 3.4(D) (Failure to Reach Agreement), it shall provide written notice to that effect to Seller. Within 20 Days of delivery of such notice Seller and Company shall agree upon an Independent Evaluator to resolve the dispute regarding a RPS Modifications Document. The Independent Evaluator shall be reasonably qualified and expert in renewable energy power generation, matters relating to the Performance Standards, financing, and power purchase agreements. If the Parties are unable to agree upon an Independent Evaluator within such 20-Day period, Company shall apply to the PUC for the appointment of an Independent Evaluator. If an Independent Observer retained under the Competitive Bidding Framework is qualified and willing and available to serve as Independent Evaluator, the PUC shall appoint one of the persons or entities qualified to serve as an Independent Observer to be the Independent Evaluator; if not, the PUC shall appoint another qualified person or entity to serve as Independent Evaluator. In its application, Company shall ask the PUC to appoint an Independent Evaluator within 30 Days of the application.
- (1) Promptly upon appointment, the Independent Evaluator shall request the Parties to address the following matters within the next 15 Days:
- (a) The reasonable measures required to be taken by Seller to cause the electric energy delivered from the Facility to come within such revised definition of "renewable electrical energy" under the RPS Amendment in question;

- (b) How Seller would implement such measures;
 - (c) Reasonably expected net costs and/or lost revenues associated with such measures so the energy delivered by the Facility complies with such revised definition of "renewable electrical energy under the RPS Amendment in question;
 - (d) The appropriate level, if any, of RPS Pricing Impact in light of the foregoing; and
 - (e) Contractual consequences for non-performance that are commercially reasonable under the circumstances.
- (2) Within 90 Days of appointment, the Independent Evaluator shall render a decision unless the Independent Evaluator determines it needs to have additional time, not to exceed 45 Days, to render a decision.
- (3) The Parties shall assist the Independent Evaluator throughout the process of preparing its review, including making key personnel and records available to the Independent Evaluator, but neither Party shall be entitled to participate in any meetings with personnel of the other Party or review of the other Party's records. However, the Independent Evaluator will have the right to conduct meetings, hearings or oral arguments in which both Parties are represented. The Parties may meet with each other during the review process to explore means of resolving the matter on mutually acceptable terms.
- (4) The following standards shall be applied by the Independent Evaluator in rendering his or her decision: (i) if it is not technically or operationally feasible for Seller to implement reasonable measures required to cause the electric energy delivered from the Facility to come within such revised definition of "renewable electrical energy" under the RPS Amendment in question, the Independent Evaluator shall determine that the Agreement shall not be amended to comply with such changes in RPS (unless the Parties agree

otherwise); (ii) if it is technically or operationally feasible for Seller to implement reasonable measures required to cause the electric energy delivered from the Facility to come within such revised definition of "renewable electrical energy" under RPS, the Independent Evaluator shall incorporate such required changes into a RPS Modifications Document including (aa) Seller's RPS Modifications, (bb) pricing terms that incorporate the RPS Pricing Impact, and (cc) contract terms and conditions that are commercially reasonable under the circumstances, especially with respect to the consequences of non-performance by Seller as to the RPS Modifications. In addition to the RPS Modifications Document, the Independent Evaluator shall render a decision which sets forth the positions of the Parties and Independent Evaluator's rationale for his or her decisions on disputed issues.

- (5) The fees and costs of the Independent Evaluator shall be paid by Company up to the first \$30,000 of such fees and costs; above those amounts, the Party that is not the prevailing Party shall be responsible for any such fees and costs; provided, if neither Party is the prevailing Party, then the fees and costs of the Independent Evaluator above \$30,000, shall be borne equally by the Parties. The Independent Evaluator in rendering his or her decision shall also state which Party prevailed over the other Party, or that neither Party prevailed over the other.

ARTICLE 4
COMPANY-OWNED INTERCONNECTION FACILITIES

The terms and conditions related to the Company-Owned Interconnection Facilities are set forth in Attachment G (Company-Owned Interconnection Facilities) of this Agreement. In accordance with Section 8 (Transfer of Ownership/Title) of Attachment G (Company-Owned Interconnection Facilities), on the Transfer Date, Seller shall convey title to the Company-Owned Interconnection Facilities that were designed and constructed by or on behalf of Seller by executing a Bill of Sale and Assignment document substantially in the form set forth in Attachment H (Form of Bill of Sale and Assignment). In addition, in accordance with Section 8 (Transfer of Ownership/Title) of Attachment G (Company-Owned Interconnection Facilities) on the Transfer Date, Seller shall deliver to Company any and all executed documents required to assign all leases with respect to the Company-Owned Interconnection Facilities to Company, which documents shall be substantially in the form set forth in Attachment I (Form of Assignment of Lease and Assumption).

ARTICLE 5
MAINTENANCE RECORDS AND SCHEDULING

5.1 Operating Records.

- (a) Seller's Logs. Seller shall maintain, at least daily, a log in which it shall record all pertinent data that will indicate whether the Facility is being operated in accordance with Good Engineering and Operating Practices. These data logs shall include, but not be limited to, all maintenance and inspection work performed at the Facility, circuit breaker trip operations, relay operations including target indications, megavar and megawatt recording charts (and/or equivalent computer records), all unusual conditions experienced or observed and any reduced capability and the reasons therefor and duration thereof. For each WTGS, the data reported shall include planned derated hours, unplanned derated hours, average derated kW during the derated hours, scheduled maintenance hours, average derated kW during scheduled maintenance hours, the number of turbine starts, hours on-control and hours on-line.
- (b) Company Access to Seller's Logs. Seller shall provide Company access to Seller's records which identify the priority, as internally assigned by Seller, of specific preventive or corrective maintenance activities. These records shall include items for which Seller has deferred the inspection or corrective action to a future scheduled plant outage. In addition, Seller shall provide copies of all written correspondence between Seller and the Facility Lender and Seller and the insurance underwriters for the Facility equipment pertaining to maintenance practices, procedures and scheduling (including deferral) of maintenance at the Facility.
- (c) Time Period for Maintaining Records. Any and all records, correspondence, memoranda and other documents or electronically recorded data related to the fueling, operation and maintenance of the Facility shall be maintained by Seller for a period of not less than six (6) years. Company shall have the right to review and copy any such items upon request.

5.2 Maintenance Records.

- (a) Seller's Summary of Maintenance and Inspection Performed. Prior to February 1 of each calendar year, Seller shall submit to Company for inspection at the Site, a summary in a format similar to the example provided in Attachment V (Summary of Maintenance and Inspection Performed in Prior Calendar Year) of all maintenance and inspection work performed in the prior calendar year, and of all conditions experienced or observed during such calendar year that may have a material adverse effect on or may materially impair the short-term or long-term operation of the Facility at the operational levels contemplated by this Agreement. The summary shall present the requested data in a meaningful and informative manner consistent with the cooperative exchange of information between the Parties. If available and practicable, such summary shall be provided in electronic format with sufficient software so that Company can group activities for specific process areas of the Facility and be able to view the maintenance history of a specific equipment item. Such summary shall also include Seller's proposals for correcting or preventing recurrences of identified equipment problems and for performing such other maintenance and inspection work as is required by Good Engineering and Operating Practices.
- (b) Company's Written Recommendations. Within sixty (60) Days of receiving such summary, and after any reasonable inspection desired by Company of the Facility and consultation with Seller, Company may provide written recommendations for specific operation or maintenance actions or for changes in the operation or maintenance program of the Facility. Company's making or failing to make recommendations with respect to operation and maintenance of the Facility shall not be construed as endorsing the operation and maintenance thereof or as any warranty of the safety, durability or reliability of the Facility nor as a waiver of any Company right. If Seller agrees with Company, Seller shall, within a reasonable time after Company makes such recommendations, not to exceed ninety (90) Days, implement Company's recommendations. If Seller disagrees with Company, it shall within ten (10) days inform Company of alternatives it will take to accomplish the same intent, or provide Company with a reasonable explanation as to why no action is

required by Good Engineering and Operating Practices. If Company disagrees with Seller's position, and if, for each of the three preceding Contract Years, the Facility PBAF was less than **90%** and/or the BOP Efficiency Ratio was less than the BOP Benchmark Minus 3, then the parties shall commission a study by a Qualified Independent Consultant chosen from the Qualified Independent Consultant List set forth in Attachment D (Consultant List) to this Agreement and the Qualified Independent Consultant will make a recommendation to remedy the situation. Seller shall abide by the Qualified Independent Consultant's recommendation contained in such study. Both Parties shall equally share in the cost for the Qualified Independent Consultant. However, Seller shall pay all costs associated with implementing the recommendation contained in the Independent Consultant's report.

- 5.3 Seller's Quarterly Maintenance Schedule: By each March 1st, June 1st, September 1st and December 1st (as applicable, subsequent to the Commercial Operations Date), Seller shall provide to Company in writing a projection of maintenance outages and reductions in capacity for the next calendar quarter, including the estimated MW that is anticipated to be off-line for each projected maintenance event. Seller shall provide Company with prompt written notice of any deviation from its quarterly maintenance schedule but in any case Seller shall provide such written notice not less than one week prior to commencing any such rescheduled maintenance event. During any scheduled or rescheduled maintenance event, Seller will provide an update each Day to Company's operating personnel regarding the status of such maintenance.
- 5.4 Seller's Annual Maintenance Schedule: In addition, Seller shall submit to Company a written schedule of maintenance outages which will reduce the capacity of the Facility by **[five (5) MW] [more than 25% of the Allowed Capacity]** or more for the next two-year period, beginning with January of the following year, in writing to Company each year by June 30. The schedule shall state the proposed dates and durations of scheduled maintenance, including the scope of work for the maintenance requiring shutdown or reduction in output of the Facility and the estimated MW that is anticipated to be off-line for each projected maintenance event. Company shall review the maintenance schedule for the two-year period and inform Seller in writing no later

than December 1 of the same year of Company's concurrence or requested revisions; provided, however, that Seller shall not be required to agree to any proposed revisions that, in Seller's judgment, will void or violate any warranties of equipment that is part of, or used in connection with, the Facility or violate any long-term service agreement with respect to such equipment, in which case Seller shall promptly notify Company thereof, and Seller and Company shall endeavor to reach a mutually satisfactory resolution of the matter in question. With respect to such agreed upon revisions, Seller shall revise its schedule for timing and duration of scheduled shutdowns and scheduled reductions of output of the Facility to accommodate Company's revisions, unless such revisions would not be consistent with Good Engineering and Operating Practices, and make all commercially reasonable efforts, consistent with Good Engineering and Operating Practices, to accommodate any subsequent changes in such schedule reasonably requested by Company.

5.5 Seller's Notification Obligations. When Seller learns that any of its equipment will be removed from or returned to service, and any such removal or return may affect the ability of the Facility to deliver electric energy to Company, Seller shall notify Company as soon as practicable. This requirement to notify shall include, but not be limited to, notice to Company of Seller's intention to shut down any WTGS such as a high wind-speed shut-down. Any WTGS shut-down shall be coordinated with Company in advance to the extent practicable to allow a reasonable amount of time for Company to make generation adjustments required by the loss of availability from a WTGS shut-down.

5.6 [Reserved]

5.7 Operating and Maintenance Manuals. Not later than the Commercial Operation Date, Seller shall provide Company with (i) any and all manufacturer's equipment manuals and recommendations for maintenance and with any updates or supplements thereto within three (3) Business Days after Seller's receipt of same and (ii) a copy of the operating and maintenance manual and shall thereafter provide Company with any amendments thereto within three (3) Business Days after such amendment is adopted.

ARTICLE 6
FORECASTING

- 6.1 Data for Calculation of Facility PBAF and for Company Forecasts and Monitoring of Compliance. Seller shall provide to Company the meteorological and production data and the Site description information required by Company in order for Company to (i) calculate Facility PBAF as provided in this Agreement, (ii) produce a real-time forecast for operations as well as a Day-ahead forecast and hourly forecasts for all variable generation facilities on the Company System and (iii) monitor Seller's compliance with the Performance Standards set forth in Section 3 (Performance Standards) of the Attachment B (Facility Owned by Seller).
- 6.2 Monitoring and Communication Equipment. Seller shall install and maintain appropriate equipment (the "Monitoring and Communication Equipment") for the purposes of (i) measuring the meteorological and production data required under Section 6.1 (Data for Calculation of Facility PBAF and for Company Forecasts and Monitoring of Compliance) with an accuracy of not less than that specified for each such data parameter in Section 8 (Data and Forecasting) of Attachment B (Facility Owned by Seller) **[and, if the monitoring equipment is part of the Company-Owned Interconnection Facilities, Section ___ of Attachment G (Company-Owned Interconnection Facilities)]** and (ii) recording and transferring such data to Company in real time. Seller shall maintain at the Site sufficient replacement parts to avoid or otherwise minimize any WTGS shutdown while any of the Monitoring and Communication Equipment is being repaired, replaced or re-calibrated. Unless the Parties agree otherwise in writing, the Monitoring and Communication Equipment to be installed and maintained by Seller shall include field device components to:
- (i) measure at each WTGS the Actual WTGS Production;
 - (ii) measure wind speed and direction at the top of the nacelle of each WTGS;
 - (iii) measure other meteorological conditions (i.e., air density, ambient air temperature, ambient air pressure and such other meteorological conditions that Company shall from time to time reasonably require,) by devices placed at approximately "hub height" of the WTGS(s) and located at one or more MMTs;

- (iv) record and transfer such data to Company in real-time; and
- (v) record and transfer to Company in real time data on the Facility's power production as measured at each WTGS.

The foregoing is in addition to the data on the Facility's Actual Output as measured by the revenue meter.

6.3 Calibrations, Maintenance and Repairs.

- (a) Documentation Requirement. Seller shall provide to Company (i) the manufacturer's recommended schedule for the calibration and maintenance of each component of the Monitoring and Communication Equipment and (ii), subject to the limitation set forth in Section 1(a)(ii) of Attachment B (Facility Owned by Seller) of this Agreement, documentation of the performance of all such calibration and maintenance per manufacturer specifications. Although Company is to receive from Seller the aforesaid recommended schedules for calibration and maintenance, as well documentation of the performance of all such calibration and maintenance, Company shall have no responsibility to monitor Seller's compliance with such calibration and maintenance schedules. Accordingly, any failure by Company to bring Seller's attention any apparent failure by Seller to perform such recommended calibration and maintenance shall neither relieve Seller of its obligations under this Agreement to perform such calibration and maintenance nor constitute a waiver of Company's rights under this Agreement with respect to such failure in performance by Seller.
- (b) Corrective Measures. In the event of a pattern of material inconsistencies in the data stream provided by the Monitoring and Communication Equipment, Seller shall perform, at Seller's expense, such corrective measures as Company may reasonably require, such as the recalibration of all field measurement device components of the Monitoring and Communication Equipment.
- (c) Repairs. In the event of any failure in the Monitoring and Communication Equipment (including but not limited to the commencement of any period during which one or more of the WTGS(s) are in the Information Unavailable

category of the Modified Information Model), Seller shall repair or replace such equipment within 15 Days of such failure or within such other time as agreed to by the Company in writing.

6.4 IU Shutdown. Because the availability to the Company System Operator of reliable meteorological and production information in real time via SCADA is necessary in order for Company to effectively optimize the benefit of its right of Company Dispatch, Company shall have the right to direct Seller to shutdown ("IU Shutdown") any WTGS or the Facility as a whole due to the unavailability of such reliable real time meteorological and/or production data for such WTGS or for the Facility as a whole. In addition, the carrying out of corrective measures (including recalibration) and/or repairs to any Monitoring and Communication Equipment pursuant to Section 6.3(b) (Corrective Measures) or Section 6.3(c) (Repairs) shall cause to be classified as an IU Shutdown any WTGS that is dependent on such Monitoring and Communication Equipment to provide reliable meteorological and production information to the Company System Operator in real time via SCADA, and such WTGS shall remain in IU Shutdown until such time as the successful completion of such corrective measures and/or repairs has been demonstrated to Company's reasonable satisfaction. As more fully set forth in Section 3 (Modified Information Model) and Section 4 (Population of Information Categories of Modified Information Model and Calculation Values) of Attachment T (Calculation and Reporting of Production-Based Availability and Dispute Resolution by Independent PBA Evaluator) to this Agreement, a WTGS that is in IU Shutdown shall be included in the "Seller-Attributable Non-Generation" information category of the Modified Information Model.

6.5 Seller Day-Ahead Forecasts of Actual Output.

(a) Forecasts. To support validation of the Company forecasts referenced in Section 6.1 (Data for Calculation of Facility PBAF and for Company Forecasts), each Day during the Term commencing on the Commercial Operations Date, Seller shall submit to Company Seller's Day-ahead hourly forecasts of the Facility's Actual Output produced by a commercially available forecasting service or by the Seller's documented methodology (i.e., climatology, persistence forecasting) for providing a forecast for the Facility's Actual Output for the next 24 hour period. Hourly Day-ahead forecasts shall be

submitted to Company by 1200 Hawai'i Standard Time on each Day immediately preceding a Day on which electric energy from the Facility is to be delivered. Seller shall provide Company with an hourly forecast of Actual Output for each hour of the next Day. Seller shall update such forecast and provide unit availability updates any time information becomes available indicating a change in the forecast of Actual Output from the Facility. The forecasts called for by this Agreement shall be substantially in the form reasonably requested by Company.

- (b) Accuracy of Forecasts. Company acknowledges that the Seller's Day-ahead forecasts are based on forecast estimates and not guarantees. Such limitation notwithstanding, Seller shall exercise commercially reasonable efforts to ensure the accuracy of the Day-ahead forecasts required hereunder for validation purposes and to support Company's forecasts. This includes a detailed description of the methodology used by Seller for forecasting. For example, Seller shall prepare such forecasts and updates by utilizing a wind power forecast or other service that is (i) commercially available or proprietary to Seller, (ii) comparable in accuracy to models or services commonly used in the wind energy industry and that reflect equipment availability, and (iii) is satisfactory to Company in the exercise of its reasonable discretion.
- (c) Company's Forecasting System. Company currently subscribes to a forecasting service. Company uses such forecasting service to set Company's dispatch schedules for all facilities. Seller, may if it chooses, subscribe to Company's forecasting service, at Seller's cost. If Seller so chooses to subscribe to Company's forecasting service and elects to use such service in lieu of creating its own forecast, Seller shall not be required to provide Day-ahead forecasts pursuant to this Section 6.5 (Seller Day-Ahead Forecasts of Actual Output).

6.6 Reports, Studies and Assessment. Prior to the Execution Date, Seller has provided Company with (1) Seller's explanation of the methodology and underlying information used to derive the NEP RFP Projection, including the preliminary design of the Facility and the typical meteorological year file used to estimate the Renewable

Resource Baseline, and (2) a written report confirming the reasonableness of NEP RFP Projection, taking into account the Renewable Resource Baseline, the preliminary design of the Facility, the provisions of this Agreement, and any other relevant factors, which report was prepared by an independent consultant experienced in utility scale wind energy generation and retained by Seller at its expense. The independent consultant was selected from among the entities listed in Section 4(h) (Acceptable Person and Entities) of Attachment U (Calculation and Adjustment of Net Energy Potential) to this Agreement. Throughout the Term, Seller shall, for purposes of facilitating Company's forecasting, deliver to Company, promptly upon Seller's receipt of same, any reports, studies or assessments prepared for the benefit of the Seller by an independent engineer of (i) the electric energy producing potential of the Site or (ii) the Facility.

ARTICLE 7
SELLER PAYMENTS

Seller shall pay to Company (i) all amounts pursuant to Attachment G (Company-Owned Interconnection Facilities), (ii) all amounts pursuant to Section 10.1 (Meters) and Section 10.2 (Meter Testing), (iii) a monthly metering charge of \$25.00 per month, which is in addition to any charges due Company pursuant to the applicable rate schedule pursuant to Section 2.8 (Sales of Electric Energy By Company to Seller) of this Agreement and (iv) such other costs to be incurred by Company and reimbursed by Seller as set forth in this Agreement.

ARTICLE 8
COMPANY DISPATCH

- 8.1 General. Company shall have the right to dispatch all available real and reactive power delivered from the Facility to the Company System and to start up and shut down Seller's generating units, as it deems appropriate in its reasonable discretion, subject only to and consistent with Good Engineering and Operating Practices, the requirements set forth in Attachment B (Facility Owned by Seller), Section 3 (Performance Standards) of this Agreement and Seller's maintenance schedule determined in accordance with Article 5 (Maintenance Records and Scheduling). Company shall not pay for reactive power.
- 8.2 Company Dispatch. Dispatch will either be by Seller's manual control under the direction of the Company System Operator or by remote computerized control by the EMS provided in Section 1(g) (Active Power Control Interface) of Attachment B (Seller's Facility), in each case at Company's reasonable discretion. Notwithstanding anything to the contrary, the power produced by the Facility shall always be subject to dispatch by Company.
- 8.3 Company Rights of Dispatch. Company may require deration or outage in response to the Facility's failure to comply with Company Dispatch, or any of the Performance Standards, Good Engineering and Operating Practices, Government Approvals, applicable Laws or Seller's other obligations under this Agreement. A deration or outage required for this reason will be considered a forced deration or forced outage of the Facility for the purpose of calculating Seller's Production-Based Availability, resulting in Seller-Attributable Non-Generation status until the conditions are resolved by Seller to Company's reasonable satisfaction. Nothing in this Section 8.3 (Company Rights of Dispatch), shall relieve Seller of its obligation under the terms of this Agreement to utilize the full capability of the Facility to deliver the capacity subject to Company Dispatch.
- 8.4 PBA Report. Commencing with the month during which the Commercial Operations Date is achieved, and for each calendar month thereafter during the Term, Seller shall calculate the PBA and prepare and provide to Company a PBA Report by the fifth (5th) Business Day of the following month in accordance with Attachment T (Calculation and Reporting of Production-Based Availability and Dispute Resolution by PBA Evaluator)

of this Agreement. Beginning with the PBA Report for the last calendar month of the initial Contract Year, Seller shall include its calculation of the Facility PBAF for the PBAF LD Period ending with the calendar month covered by such PBA Report, as well as the calculation of any liquidated damages to be assessed for such PBAF LD Period, in the form of the PBA Report set forth in Section 6 (PBA Report) of said Attachment T. The rights and obligations of the Parties with respect to each PBA Report and any disagreements arising out of any PBA Report are set forth in Section 6 (PBA Report) and Section 7 (Disagreements Concerning Historical Power Curve, Production-Based Availability and BOP Benchmark) of Attachment T (Calculation and Reporting of Production-Based Availability and Dispute Resolution by PBA Evaluator) to this Agreement.

ARTICLE 9
PERSONNEL AND SYSTEM SAFETY

Notwithstanding any other provisions of this Agreement, if at any time Company reasonably determines that the Facility may endanger Company's personnel, and/or the continued operation of the Facility may endanger the integrity of the Company System or have an adverse effect on Company's other customers' electric service, Company shall have the right to disconnect the Facility from the Company System, as determined in the sole discretion of the Company System Operator. The Facility shall immediately comply with the dispatch instruction, which may be initiated through remote control, and shall remain disconnected, until such time as Company is satisfied that the condition(s) referred to above have been corrected, and the period during which the Facility is disconnected pursuant to this Article 9 shall constitute Seller-Attributable Non-Generation under the Modified Information Model. If Company disconnects the Facility from the Company System for personnel or system safety reasons, it shall as soon as practicable notify Seller by telephone, and thereafter confirm in writing, the reasons for the curtailment or disconnection.

ARTICLE 10
METERING

- 10.1 Meters. Company shall purchase, own, install and maintain the Revenue Metering Package suitable for measuring the export of electric energy from the Facility sold to Company in kilowatts and kilowatt-hours on a time-of-day basis and of reactive power flow in kilovars and true root mean square kilovar-hours. The metering point shall be as close as possible to the Point of Interconnection as allowed by Company. Seller shall make available a mutually agreeable location for the Revenue Metering Package. Seller shall install, own and maintain the infrastructure and other related equipment associated with the Revenue Metering Package, including but not limited to all enclosures (meter cabinets, meter pedestals, meter sockets, pull boxes, and junction boxes, along with their grounding/bonding connections), CT/PT mounting structures, conduits and ductlines, enclosure support structures, ground buses, pads, test switches, terminal blocks, isolation relays, telephone surge suppressors, and analog phone lines (one per meter), subject to Company's review and approval, as further described in Section 1(e) (Other Equipment) of Attachment B (Facility Owned by Seller). The Seller shall install this infrastructure such that it meets the requirements set forth in Chapter Six (IPP Metering) of the latest edition of the Company's Electric Service Installation Manual (ESIM). Company shall test such revenue meter prior to installation and shall test such revenue meter every fifth year. Seller shall reimburse Company for all reasonably incurred costs for the procurement, installation, maintenance (including maintenance replacements) and testing work associated with the Revenue Metering Package.
- 10.2 Meter Testing. Company shall provide at least twenty-four (24) hours' notice to Seller prior to any test it may perform on the revenue meters or metering equipment. Seller shall have the right to have a representative present during each such test. Seller may request, and Company shall perform, if requested, tests in addition to the every fifth-year test and Seller shall pay the cost of such tests. Company may, in its sole discretion, perform tests in addition to the fifth year test and Company shall pay the cost of such tests. If any of the revenue meters or metering equipment is found to be inaccurate at any time, as determined by testing in accordance with this Section 10.2 (Meter Testing), Company shall promptly cause such equipment

to be made accurate, and the period of inaccuracy, as well as an estimate for correct meter readings, shall be determined in accordance with Section 10.3 (Corrections).

- 10.3 Corrections. If any test of revenue meters or metering equipment conducted by Company indicates that the revenue meter readings are in error by one percent (1%) or more, the revenue meters or meter readings shall be corrected as follows: (i) determine the error by testing the revenue meter at approximately ten percent (10%) of the rated current (test amperes) specified for such revenue meter; (ii) determine the error by testing the revenue meter at approximately one hundred percent (100%) of the rated current (test amperes) specified for the revenue meter; (iii) the average meter error shall then be computed as the sum of (aa) one-fifth (1/5) of the error determined in the foregoing clause "(i)" and (bb) four-fifths (4/5) of the error determined in the foregoing clause "(ii)". The average meter error shall be used to adjust the invoices in accordance with Section 2.13 (Adjustment to Invoices After Payment) for the amount of electric energy supplied to Company for the previous six (6) months from Facility, unless records of Company conclusively establish that such error existed for a greater or lesser period, in which case the correction shall cover such actual period of error.

ARTICLE 11
GOVERNMENT APPROVALS,
LAND RIGHTS AND COMPLIANCE WITH LAWS

- 11.1 Governmental Approvals for Facility. Seller shall obtain, at its expense, any and all Governmental Approvals required for the construction, ownership, operation and maintenance of the Facility and the interconnection of the Facility to the Company System.
- 11.2 Land Rights for Facility. Seller shall obtain, at its expense, any and all Land Rights required for the construction, ownership, operation and maintenance of the Facility and the interconnection of the Facility to the Company System. Seller shall provide to Company, no later than the Execution Date, copies of the documents, recorded, if required by Company (including but not limited to any agreements with landowners) (i) establishing the right of Seller to construct, own, operate and maintain the Facility on the Site and (ii) any other Land Rights required for such construction, ownership, operation and maintenance.
- 11.3 Company-Owned Interconnection Facilities. Seller shall, prior to commencement of construction of Company-Owned Interconnection Facilities (whether to be built by Seller or by Company), provide the necessary Governmental Approvals and Land Rights for the interconnection of the Facility to the Company System, including the construction, ownership, operation and maintenance of Company-Owned Interconnection Facilities.
- 11.4 Compliance With Laws. Seller shall at all times comply with all applicable Laws and shall be responsible for all costs and expenses associated therewith.

ARTICLE 12
TERM OF AGREEMENT AND COMPANY'S
OPTION TO PURCHASE AT END OF TERM

- 12.1 Term. Subject to Section 12.2 (Effectiveness of Obligations) of this Agreement, the initial term of this Agreement shall commence upon the Execution Date of this Agreement and, unless terminated sooner as provided in this Agreement, shall remain in effect for **[twenty (20) Contract Years]** following the Commercial Operations Date (the "Initial Term"). This Agreement shall automatically terminate upon expiration of the Initial Term. If the Parties desire, the Parties may negotiate terms and conditions of an extension term ("Extended Term"), including reduced Contract Pricing in recognition that Seller will have recovered its capital and financing costs, which terms and conditions (i) shall be submitted to the PUC by Company for approval no later than one (1) year prior to the expiration of the Initial Term and (ii) shall have no effect without PUC approval.
- 12.2 Effectiveness of Obligations. Only Article 3 (Facility Owned and/or Operated by Seller), Article 12 (Term of Agreement and Company's Option to Purchase at End of Term), Article 14 (Credit Assurance and Security) as it relates to Development Period Security, Article 17 (Indemnification), Article 19 (Transfers, Assignments and Facility Debt), Article 22 (Warranties and Representations), Article 24 (Financial Compliance), Article 28 (Dispute Resolution), Article 29 (Miscellaneous), Section 3 (Seller Payment to Company for Company-Owned Interconnection Facilities and Review of Facility) of Attachment G (Company-Owned Interconnection Facilities) and the Definitions of this Agreement shall become effective on the Execution Date. Except where obligations of the Parties are explicitly stated as being effective before the Effective Date, all other portions of this Agreement shall become effective on the Effective Date.
- 12.3 PUC Approval.
- (a) This Agreement is subject to approval by the PUC in the form of a satisfactory PUC Approval Order and the Parties' respective obligations hereunder are conditioned upon receipt of such approval, except as specifically provided otherwise herein. Upon the Execution Date of this Agreement, the Parties shall

use good faith efforts to obtain, as soon as practicable, a PUC Approval Order that satisfies the requirements of Section 29.20(a) (PUC Approval Order). Company shall submit to the PUC an application for a satisfactory PUC Approval Order but does not extend any assurances that a PUC Approval will ultimately be obtained. Seller will provide reasonable cooperation to expedite obtaining a PUC Approval Order including timely providing information requested by the PUC and parties to the PUC proceeding in which approval is being sought. Seller understands that lack of cooperation may result in Company's inability to file an application with the PUC and/or a failure to receive a PUC Approval Order. For the avoidance of doubt, Company has no obligation to seek reconsideration, appeal, or other administrative or judicial review of any Unfavorable PUC Order. The Parties agree that neither Party has control over whether or not a PUC Approval Order will be issued and each Party hereby assumes any and all risks arising from, or relating in any way to, the inability to obtain a satisfactory PUC Approval Order and hereby releases the other Party from any and all claims relating thereto.

- (b) Seller shall seek participation without intervention in the PUC docket for approval of this Agreement pursuant to applicable rules and orders of the PUC. The scope of Seller's participation shall be determined by the PUC. However, Seller expressly agrees to seek participation for the limited purpose and only to the extent necessary to assist the PUC in making an informed decision regarding the approval of this Agreement. If the Seller chooses not to seek participation in the docket, then Seller expressly agrees and knowingly waives any right to claim, before the PUC, in any court, arbitration or other proceeding, that the information submitted and the arguments offered by Company in support of the application requesting the PUC Approval Order are insufficient to meet Company's burden of justifying that the terms of this Agreement are just and reasonable and in the public interest, or otherwise deficient in any manner for purposes of supporting the PUC's approval of this Agreement. Seller shall not seek in the docket and Company shall not disclose any confidential information to Seller that would provide

Seller with an unfair business advantage or would otherwise harm the position of others with respect to their ability to compete on equal and fair terms.

12.4 Interconnection Requirements Study. If this Agreement is executed prior to completion of the Interconnection Requirements Study, then following the completion of the IRS:

- (a) The Parties shall, no later than the PPA Amendment Deadline, execute a formal amendment to this Agreement substituting new versions of Attachment B (Facility Owned by Seller), Attachment E (Single-Line Drawings and Interface Block Diagram), Attachment F (Relay List and Trip Scheme), Attachment G (Company-Owned Interconnection Facilities), Attachment K (Guaranteed Project Milestones), and Attachment L (Reporting Milestones) (the "Interconnection Requirements Amendment") to reflect the results of the IRS. If the Interconnection Requirements Amendment is not executed by the PPA Amendment Deadline, either Party may, by written notice delivered to the other Party, declare the Agreement null and void; or
- (b) If Seller is dissatisfied with the results of the IRS, Seller shall have the option, by written notice delivered to Company no later than the Termination Deadline, to declare this Agreement null and void. Failure of Seller to declare this Agreement null and void pursuant to the preceding sentence shall not obligate Seller to execute the Interconnection Requirements Amendment.

12.5 Prior to Effective Date. Company may, by written notice delivered prior to the Effective Date, declare the Agreement null and void if any one or more of the following conditions applies:

- (a) Company reasonably determines that the description of the Facility in the Agreement and the IRS no longer represents the Facility Seller is capable of constructing because of changes in the type of, performance specifications of, or availability of equipment.
- (b) Seller is in breach of any of its representations, warranties and covenants under the Agreement,

including, but not limited to, (i) the provisions of Section 22.2(c) requiring Seller to have obtained by the Execution Date all Land Rights necessary for the construction, ownership, operation and maintenance of the Facility for the Initial Term and (ii) the provisions of Section 3(b)(ii) (Company-Owned Interconnection Facilities Prepayment) of Attachment G (Company-Owned Interconnection Facilities) requiring the payment by Seller to Company of the amount specified in said Section 3(b)(ii) within the time period provided in said Section 3(b)(ii).

- (c) Seller, subsequent to making the payment to Company required under Section 3(b)(ii) (Company-Owned Interconnection Facilities Prepayment) of Attachment G (Company-Owned Interconnection Facilities), requests in writing that Company stop or otherwise delay the performance of the work for which Company received such payment.
- (d) Seller has notified Company in writing that it desires to modify (i) the Agreement and/or (ii) the Facility as described in the Agreement and the IRS.
- (e) Seller fails to cause the Facility Lender to make available to Company an IE Energy Assessment report with an NEP IE Estimate that is consistent with the requirements of this Agreement, as more fully provided in Section 1(c) (NEP IE Estimate and Company-Designated NEP Estimate) of Attachment U (Calculation and Adjustment of Net Energy Potential) to this Agreement.

12.6 Time Periods for PUC Submittal Date and PUC Approval.

- (a) Time Period for PUC Submittal Date. If the PUC Submittal Date has not occurred within 120 Days of the Execution Date, or such longer period as Company and Seller may agree to by a subsequent written agreement, Company may, by written notice delivered within 30 Days of the expiration of such period, declare the Agreement null and void if the reason the application has not been filed is (i) any one or more of the conditions set forth in Section 12.5 (Prior to Effective Date) or (ii) Seller's failure to provide in a timely manner information reasonably requested by Company to support such application.

(b) Time Period for PUC Approval. If the Commission issues an Unfavorable PUC Order or if the satisfactory PUC Approval Order is not obtained within twelve (12) months of the PUC Submittal Date, or within such longer period as Company and Seller may agree to by a written agreement ("PUC Approval Time Period"), Company or Seller may, by written notice delivered within one hundred and eighty (180) Days of the Unfavorable PUC Order or the expiration of the PUC Approval Time Period, as applicable, declare this Agreement null and void. In the event the PUC Approval Order is obtained within the PUC Approval Time Period but that Order is appealed, and a Non-appealable PUC Approval Order is not obtained within PUC Approval Time Period, or within such longer period as Company and Seller may agree to by a subsequent written agreement, Company or Seller may, by written notice delivered within ninety (90) Days of the expiration of the PUC Approval Time Period, declare this Agreement null and void.

12.7 Agreement Null and Void. If the Agreement is declared null and void pursuant to Section 12.4 (Interconnection Requirements Study), Section 12.5 (Prior to Effective Date), Section 12.6 (Time Periods for PUC Submittal Date and PUC Approval), Section 1(c) (NEP IE Estimate and Company-Designated NEP Estimate) of Attachment U (Calculation and Adjustment of Net Energy Potential) or Section 1(d) (NEP IE Estimate, Liquidated Damages and Seller's Null and Void Right) of said Attachment U, the Parties hereto shall thereafter be free of all obligations hereunder except as set forth in this Section 12.7 (Agreement Null and Void) and Section 14.3 (Return of Development Period Security), and shall pursue no further remedies against one another; provided, however, that if in response to Seller's request and Seller's offer of adequate assurance of reimbursement, Company agrees in writing to incur costs associated with Company-Owned Interconnection Facilities prior to the Non-appealable PUC Approval Order Date or completion of the IRS, Seller shall pay Company the actual costs and cost obligations incurred by Company as of the date the Agreement is declared null and void for Company-Owned Interconnection Facilities and any reasonable costs incurred thereafter and Company shall refund to Seller any amounts advanced by Seller in excess of such costs. A declaration that this Agreement is null and void pursuant to Section 12.4 (Interconnection Requirements Study), Section 12.5 (Prior to

Effective Date), Section 12.6 (Time Periods for PUC Submittal Date and PUC Approval), Section 1(c) (NEP IE Estimate and Company-Designated NEP Estimate) of Attachment U (Calculation and Adjustment of Net Energy Potential) or Section 1(d) (NEP IE Estimate, Liquidated Damages and Seller's Null and Void Right) of said Attachment U, shall not affect the following provisions, which shall remain in full force and effect: Section 12.2 (Effectiveness of Obligations), this Section 12.7 (Agreement Null and Void), Article 28 (Dispute Resolution), Section 29.3 (Notices), Section 29.8 (Governing Law, Jurisdiction and Venue), Section 29.14 (Settlement of Disputes), Section 29.19 (Computation of Time), Section 29.23 (No Third Party Beneficiaries), Section 29.24 (Hawai'i General Excise Tax), and Section 7 (Land Restoration) of Attachment G (Company-Owned Interconnection Facilities).

- 12.8 Termination Rights. Notwithstanding any of the foregoing, Company or Seller may terminate the Agreement at any time upon the occurrence of any condition described in Article 15 (Events of Default).
- 12.9 Option to Purchase Facility and Right of First Negotiation. Company shall have the right of first negotiation prior to the end of the Term and option to purchase the Facility at the end of the Term, as provided in Attachment P (Sale of Facility by Seller) to this Agreement.

ARTICLE 13
GUARANTEED PROJECT MILESTONES
INCLUDING COMMERCIAL OPERATIONS

[HECO TO DECIDE, FOLLOWING COMPLETION OF IRS, IF ANY GUARANTEED PROJECT MILESTONES ARE NECESSARY IN ADDITION TO THE GUARANTEED SUBSTANTIAL COMMITMENT DATES AND THE GCOD (INCLUDING WHETHER ANY REPORTING MILESTONES SHOULD BECOME GUARANTEED PROJECT MILESTONES) AND, IF SO, WHAT ARE THE CONSEQUENCES OF MISSING SUCH OTHER GUARANTEED PROJECT MILESTONES.]

- 13.1 Time is of the Essence. Time is of the essence of this Agreement, and Seller's ability to achieve the Construction Milestones is critically important.
- 13.2 Failure to Meet Certain Reporting Milestones. If Seller does not meet any of the Permit Application Filing Date Milestone, the Construction Financing Closing Milestone or the Construction Start Date Milestone, in each case as set forth in Attachment L (Reporting Milestones), Seller shall submit to Company, within ten (10) Business Days of any such missed Reporting Milestone, a remedial action plan which shall provide a detailed description of Seller's course of action and plan to achieve (i) the missed Reporting Milestone date within ninety (90) Days of the missed Reporting Milestone and (ii) all subsequent Construction Milestones, provided that delivery of any remedial action plan shall not relieve Seller of its obligation to meet any subsequent Construction Milestones.
- 13.3 Guaranteed Project Milestone Dates. Seller shall achieve each Guaranteed Project Milestone Date, subject (to the extent applicable) to the following grace periods:
- (a) if the failure to achieve Commercial Operations by the Guaranteed Commercial Operations Date is the result of the PUC Approval Order Date occurring more than one hundred eighty (180) Days after the Execution Date, Seller shall be entitled to a grace period following the Guaranteed Commercial Operation Date equal to the lesser of (i) the number of Days that elapse between the end of the aforesaid 180-Day period and the PUC Approval Order Date, or (ii) the number of Days following the Guaranteed Commercial Operations Date that are reasonably necessary for Seller, using reasonable diligence to achieve the Commercial Operations Date in the shortest period of time; **[THIS**

PARAGRAPH SHOULD BE DELETED IF THE GCOD IS A PERIOD OF DAYS MEASURED FROM THE EFFECTIVE DATE RATHER THAN A DATE CERTAIN. NOTE THAT THE "PUC APPROVAL ORDER DATE" IS THE DATE THE ORDER IS ISSUED AND NOT THAT IT BECOMES NON-APPEALABLE.] or

- (b) if the failure to achieve a Guaranteed Project Milestone by the applicable Guaranteed Project Milestone Date is the result of Force Majeure (which, for purposes of this Section 13.3(b) excludes any delay in obtaining the PUC Approval Order because that contingency is addressed in Section 13.3(a) above) **[PRECEDING PARENTHETICAL SHOULD BE DELETED IF SECTION 13.3(a) IS DELETED]**, and if and so long as the conditions set forth in Section 21.4 (Satisfaction of Certain Conditions) are satisfied, Seller shall be entitled to a grace period following such Guaranteed Project Milestone Date equal to the lesser of three hundred sixty-five (365) Days or the duration of the Force Majeure.
- (c) if the failure to achieve a Guaranteed Project Milestone by the applicable Guaranteed Project Milestone Date is the result of any failure by Company in the timely performance of its obligations under this Agreement, Seller shall be entitled to a grace period following such Guaranteed Project Milestone Date equal to the duration of the period of delay directly caused by such failure in Company's timely performance. Such grace period on the terms described above shall be Seller's sole remedy for any such failure by Company. For purposes of this Section 13.3(c), Company's performance will be deemed to be "timely" if it is accomplished within the time period specified in this Agreement with respect to such performance or, if no time period is specified, within a reasonable period of time. If the performance in question is Company's review of plans, the determination of what is a "reasonable period of time" will take into account Company's past practices in reviewing and commenting on plans for similar facilities.

13.4 Damages and Termination.

(a) Daily Delay Damages.

- (1) If a Guaranteed Project Milestone (other than Commercial Operations) has not been achieved by the applicable Guaranteed Project Milestone Date as extended as provided in Section 13.3 (Guaranteed Project Milestone Dates), Company shall collect and Seller shall pay liquidated damages in the amount of [REDACTED] for each Day ("Daily Delay Damages") following the applicable Guaranteed Project Milestone Date or (if applicable) the expiration of such extended period that Seller fails to achieve the applicable Guaranteed Project Milestone; provided, however, that the number of Days for which Company shall collect and Seller shall pay Daily Delay Damages for a failure to achieve a Guaranteed Project Milestone Date shall not exceed sixty (60) Days for each such missed Guaranteed Project Milestone Date (the "Construction Delay LD Period"). **[Note: Contract Capacity x \$50/kW ÷ 180 Days = Daily Delay Damages.]**
- (2) If the Commercial Operations Date has not been achieved by the Guaranteed Commercial Operations Date as extended as provided in Section 13.3 (Guaranteed Project Milestone Dates), and in addition to any Daily Delay Damages collected pursuant to Section 13.4(a)(1), Company shall collect and Seller shall pay Daily Delay Damages following the Guaranteed Commercial Operations Date or (if applicable) the expiration of such extended period that Seller fails to achieve the Guaranteed Commercial Operations Date, provided that the number of Days for which Company shall collect and Seller shall pay Daily Delay Damages for failing to achieve the Guaranteed Commercial Operations Date shall not exceed one hundred eighty (180) Days (the "COD Delay LD Period").
- (b) Termination and Termination Damages for Failure to Achieve a Guaranteed Project Milestone Date. If, upon the expiration of the Construction Delay LD Period or the COD Delay LD Period, as applicable, Seller has not achieved the Guaranteed Project Milestone Date, Company shall have the right, notwithstanding any other provision of this Agreement to the contrary, to terminate this Agreement with immediate effect by issuing a written termination notice to Seller

designating the Day such termination is to be effective, provided that Company shall issue such notice no later than thirty (30) Days following the expiration of the Construction Delay LD Period or the COD Delay LD Period, as applicable. The effective date of such termination shall be not later than the date that is thirty (30) Days after such notice is deemed to be received by Seller, and not earlier than the later to occur of the Day such notice is deemed to be received by Seller or the Day following the expiration of the Construction Delay LD Period or the COD Delay LD Period, as applicable. Without limiting the generality of the preceding sentence, the earliest Day upon which a termination of this Agreement can be effective as a result of a failure to achieve Guaranteed Project Milestone would be the Day following expiration of the COD Delay LD Period. If the Agreement is terminated by Company pursuant to this Section 13.4 (Damages and Termination), Company shall have the right to collect liquidated damages ("Termination Damages"), which shall be calculated in accordance with Article 16 (Damages in the Event of Termination By Company) of this Agreement.

- 13.5 Payment of Daily Delay Damages. Company shall draw upon the Development Period Security on a monthly basis for payment of the total Daily Delay Damages incurred by Seller during the preceding calendar month. If the Development Period Security is at any time insufficient to pay the amount of the draw to which Company is then entitled, Seller shall pay any such deficiency to Company promptly upon demand.
- 13.6 Liquidated Damages Appropriate. Seller's inability to achieve Commercial Operations by the Guaranteed Commercial Operations Date may cause Company to not meet applicable RPS requirements and require Company to devote substantial additional resources for administration and oversight activities. As such, Company may incur financial consequences for failure to meet such requirements. Consequently, each Party agrees and acknowledges that (i) the damages that Company would incur due to delay in achieving Commercial Operations by the Guaranteed Commercial Operations Date (subject to the grace periods provided in Section 13.3 (Guaranteed Project Milestone Dates)) would be difficult or impossible to calculate with certainty, (ii) the Daily Delay Damages set forth in Section 13.4 (Damages and Termination) are an appropriate approximation

of such damages and (iii) the Daily Delay Damages are the sole and exclusive remedies for Seller's failure to achieve Commercial Operations by the Guaranteed Commercial Operations Date.

- 13.7 Monthly Progress Reports. Commencing upon the Execution Date of this Agreement, Seller shall submit to Company, on the first Day of each calendar month until the Commercial Operations Date is achieved, progress reports in a form set forth on Attachment S (Monthly Progress Report) (the "Monthly Progress Report"). These progress reports shall notify Company of the current status of each Construction Milestone. Seller shall include in such report a list of all letters, notices, applications, filings and Governmental Approvals sent to or received from any Governmental Authority and shall provide any such documents as may be reasonably requested by Company. In addition, Seller shall advise Company as soon as reasonably practicable of any problems or issues of which it is aware which may materially impact its ability to meet the Construction Milestones. Seller shall provide Company with any requested documentation to support the achievement of Construction Milestones within ten (10) Business Days of receipt of such request from Company. Upon the occurrence of a Force Majeure, Seller shall also comply with the requirements of Section 21.4 (Satisfaction of Certain Conditions) to the extent such requirements provide for communications to Company beyond those required under this Section 13.7 (Monthly Progress Reports).

ARTICLE 14
CREDIT ASSURANCE AND SECURITY

- 14.1 General. Seller is required to post and maintain Development Period Security and Operating Period Security based on the requirements of this Article 14 (Credit Assurance and Security).
- 14.2 Development Period Security. To guarantee undertaking the performance of Seller's obligations under the Agreement for the period prior to the Commercial Operations Date (including but not limited to Seller's obligation to meet the Guaranteed Commercial Operations Date), Seller shall provide Development Period Security to Company within ten (10) Days of Execution Date of the Agreement.
- 14.3 Return of Development Period Security. The Development Period Security shall be returned to Seller, subject to Company's right to draw from the Development Period Security as set forth in Section 14.7 (Company's Right to Draw from Security Funds), in the following circumstances: (i) this Agreement is declared null and void pursuant to any of Section 12.4 (Interconnection Requirements Study), Section 12.5 (Prior to Effective Date), Section 12.6 (Time Periods for PUC Submittal Date and PUC Approval), Section 1(c) (NEP IE Estimate and Company-Designated NEP Estimate) of Attachment U (Calculation and Adjustment of Net Energy Potential) or Section 1(d) (NEP IE Estimate, Liquidated Damages and Seller's Null and Void Right) of said Attachment U; (ii) the PUC issues an order denying approval for an application for a PUC Approval Order; (iii) the PUC issues an order that is not a complete approval and which is not satisfactory to Company; or (iv) following Company's receipt of the Operating Period Security, unless the Development Period Security is converted to Operating Period Security pursuant to Section 14.4 (Operating Period Security) of this Agreement.
- 14.4 Operating Period Security. To guarantee the performance of Seller's obligations under the Agreement for the period starting from the Commercial Operations Date to the expiration or termination of this Agreement, Seller shall provide operating period security to Company in the amount of \$75/kW based on the Contract Capacity (the "Operating Period Security"). When the Commercial Operations Date has been achieved, the Development Period Security minus an amount that is due and owing to Company but not previously

paid by Seller (including but not limited to Daily Delay Damages), shall be converted to Operating Period Security unless the Parties otherwise agree. Any additional amount necessary to fully fund the Operating Period Security shall be due within five (5) Days of the Commercial Operations Date.

14.5 Form of Security. Seller shall supply the Development Period and Operating Period Security required in the form of an irrevocable standby letter of credit with no documentation requirement substantially in the form attached to this Agreement as Attachment M (Form of Letter of Credit) from a bank or other financial institution located in the United States with a credit rating of "A-" or better. If the rating (as measured by Standard & Poor's) of the bank or financial institution issuing the standby letter of credit falls below A-, Company may require Seller to replace the standby letter of credit with a standby letter of credit from another bank or financial institution located in the United States with a credit rating of "A-" or better. Such letter of credit shall be issued for a minimum term of one (1) year. Furthermore, at the end of each year the security shall be renewed for an additional one (1) year term so that at the time of such renewal, the remaining term of any such security shall not be less than one (1) year. The letter of credit shall include a provision for at least thirty (30) Days advance notice to Company of any expiration or earlier termination of the letter of credit so as to allow Company sufficient time to exercise its rights under said security if Seller fails to extend or replace the security. In all cases, the reasonable costs and expenses of establishing, renewing, substituting, canceling, increasing, reducing, or otherwise administering the letter of credit shall be borne by Seller.

14.6 Security Funds. The Development Period Security and Operating Period Security (collectively referred to as the "Security Funds") established, funded, and maintained by Seller pursuant to the provisions of this Article 14 (Credit Assurance and Security) shall provide security for the performance of Seller's obligations under this Agreement and shall be available to be drawn on by Company as provided in Section 14.7 (Company's Right to Draw from Security Funds). Seller shall maintain the Security Funds at the contractually-required level throughout the Term of this Agreement. Seller shall replenish the Security Funds to such required level within fifteen (15) Business Days after

any draw on the Security Funds by Company or any reduction in the value of Security Funds below the required level for any other reason.

- 14.7 Company's Right to Draw from Security Funds. In addition to any other remedy available to it, Company may, before or after termination of this Agreement, draw from the Security Funds such amounts as are necessary to recover amounts Company is owed pursuant to this Agreement or the IRS Letter Agreement, including, without limitation, any damages due Company, any interconnection costs owed pursuant to Attachment G (Company-Owned Interconnection Facilities) and any amounts for which Company is entitled to indemnification under this Agreement. Company may, in its sole discretion, draw all or any part of such amounts due Company from any of the Security Funds to the extent available pursuant to this Article 14 (Credit Assurance and Security), and from all such forms, and in any sequence Company may select. Any failure to draw upon the Security Funds or other security for any damages or other amounts due Company shall not prejudice Company's rights to recover such damages or amounts in any other manner.
- 14.8 Failure to Renew or Extend Letter of Credit. If the letter of credit is not renewed or extended at least thirty (30) Days prior to its expiration or earlier termination, Company shall have the right to draw immediately upon the full amount of the letter of credit and to place the proceeds of such draw (the "L/C Proceeds"), at Seller's cost, in an escrow account in accordance with Section 14.9 (L/C Proceeds Escrow), until and unless Seller provides a substitute letter of credit meeting the requirements of this Article 14 (Credit Assurance and Security).
- 14.9 L/C Proceeds Escrow. If Company draws on the letter of credit pursuant to Section 14.8 (Failure to Renew or Extend Letter of Credit), Company shall, in order to avoid comingling the L/C Proceeds, have the right but not the obligation to place the L/C Proceeds in an escrow account as provided in this Section 14.9 (L/C Proceeds Escrow) with a reputable escrow agent acceptable to Company ("Escrow Agent"). Without limitation to the generality of the foregoing, a federally-insured bank shall be deemed to be a "reputable escrow agent." Company shall have the right to apply the L/C Proceeds as necessary to recover amounts Company is owed pursuant to this Agreement or the IRS Letter Agreement, including, without limitation, any damages due

Company, any interconnection costs owed pursuant to Attachment G (Company-Owned Interconnection Facilities) and any amounts for which Company is entitled to indemnification under this Agreement. To that end, the documentation governing such escrow account shall be in form and content satisfactory to Company and shall give Company the sole authority to draw from the account. Seller shall not be a party to such documentation and shall have no rights to the L/C Proceeds. Upon full satisfaction of Seller's obligations under this Agreement, including recovery by Company of amounts owed to it under this Agreement, Company shall instruct the Escrow Agent to remit to the bank that issued the letter of credit that was the source of the L/C Proceeds the remaining balance (if any) of the L/C Proceeds. If there is more than one escrow account with L/C Proceeds, Company may, in its sole discretion, draw on such accounts in any sequence Company may select. Any failure to draw upon the L/C Proceeds for any damages or other amounts due Company shall not prejudice Company's rights to recover such damages or amounts in any other manner.

- 14.10 Release of Security Funds. Promptly following the end of the Term, and the complete performance of all of Seller's obligations under this Agreement, including but not limited to the obligation to pay any and all amounts owed by Seller to Company under this Agreement, Company shall release the Security Funds to Seller.

ARTICLE 15
EVENTS OF DEFAULT

15.1 Events of Default by Seller. The occurrence of any of the following shall constitute an Event of Default by Seller:

- (a) if at any time during the Term, Seller delivers or attempts to deliver to the Point of Interconnection for sale under this Agreement electric energy that was not generated by the Facility;
- (b) if at any time subsequent to the Commercial Operations Date, the Facility PBAF is less than **80%** for each of three consecutive Contract Years;
- (c) if at any time subsequent to the Commercial Operations Date, the BOP Efficiency Ratio is less than BOP Benchmark Minus 6 for each of three consecutive Contract Years;
- (d) if at any time subsequent to the Commercial Operations Date, the Facility is unavailable to provide electric energy in response to Company Dispatch for a period of three hundred sixty-five (365) or more consecutive Days;
- (e) if at any time during the Term, Seller fails to satisfy the Credit Assurance and Security requirements agreed to pursuant to Article 14 (Credit Assurance and Security) of this Agreement;
- (f) if at any time during the Term, Seller fails to comply with the requirements of Section 19.1 (Sale of Facility) and Attachment P (Sale of Facility by Seller);
- (g) if at any time during the Term, the Facility Lender declares a default under the Financing Documents and then fails to initiate, within sixty (60) Days thereafter, such actions as may be legally necessary (such as foreclosure) to take possession of the Facility and to thereafter diligently prosecute such actions to conclusion; or
- (h) if at any time subsequent to the Commercial Operations Date, Seller fails to install, operate, maintain, or repair the Facility in accordance with Good Engineering and Operating Practices if such failure is

not cured within thirty (30) Days after written notice of such failure from Company unless such failure cannot be cured within said thirty (30) Day period and Seller is making commercially reasonable efforts to cure such failure, in which case Seller shall have a cure period of one hundred eighty (180) Days after Company's written notice of such failure.

[DRAFTING NOTE FOR MECO: IF PROJECT IS LOCATED AT MECO'S WAENA SITE, PPA IS TO BE CROSS-DEFAULTED TO GROUND LEASE.]

15.2 Events of Default by a Party. The occurrence of any of the following during the Term of the Agreement shall constitute an Event of Default by the Party responsible for the failure, action or breach in question:

- (a) The failure to make any payment required pursuant to this Agreement when due if such failure is not cured within ten (10) Business Days after written notice is received by the Party failing to make such payment;
- (b) Any representation or warranty made by such Party herein is false and misleading in any material respect when made;
- (c) Such Party becomes insolvent, or makes an assignment for the benefit of creditors or fails generally to pay its debts as they become due; or such Party shall have an order for relief in an involuntary case under the bankruptcy laws as now or hereafter constituted entered against it, or shall commence a voluntary case under the bankruptcy laws as now or hereafter constituted, or shall file any petition or answer seeking for itself any arrangement, composition, adjustment, liquidation, dissolution or similar relief to which it may be entitled under any present or future statute, law or regulation, or shall file any answer admitting the material allegations of any petition filed against it in such proceeding; or such Party seeks or consents to or acquiesces in the appointment of or taking possession by, any custodian, trustee, receiver or liquidator of it or of all or a substantial part of its properties or assets; or such Party takes action looking to its dissolution or liquidation; or within ninety (90) days after commencement of any proceedings against such Party seeking any arrangement, composition, adjustment,

liquidation, dissolution or similar relief under any present or future statute, law or regulation, such proceedings shall not have been dismissed; or within ninety (90) days after the appointment of, or taking possession by, any custodian, trustee, receiver or liquidator of any or of all or a substantial part of the properties or assets of such Party, without the consent or acquiescence of such Party, any such appointment or possession shall not have been vacated or terminated;

- (d) Such Party engages in or is the subject of a transaction requiring the prior written consent of the other Party under Section 19.2 (Assignment by Seller) or Section 19.7 (Assignment By Company) (as applicable) without having obtained such consent;
- (e) Such Party fails to comply with either (i) decision under Article 28 (Dispute Resolution), (ii) or an Independent Evaluator's decision under Article 23 (Process for Addressing Revisions to Performance Standards), in either case within thirty (30) Days after such decision becomes binding on the Parties in accordance with Article 28 (Dispute Resolution) or within thirty (30) Days of the issuance of such decision under Article 23 (Process for Addressing Revisions to Performance Standards), as applicable, or, if such decision cannot be complied with within thirty (30) Days, such Party fails to have commenced commercially reasonable efforts designed to achieve compliance within such thirty (30) Days and diligently continue such commercially reasonable efforts until compliance is attained; or
- (f) A Party, by act or omission, materially breaches or defaults on any material covenant, condition or other provision of this Agreement, other than the provisions specified in Section 15.1 (Events of Default by Seller) and Section 15.2(a) through Section 15.2(e), if such breach or default is not cured within thirty (30) Days after written notice of such breach or default from the other Party; provided, however, that if it is objectively impossible to cure the breach or default in question within said thirty (30) Day period (i.e., if the breach or default in question is one that could not be cured within said thirty (30) Day period by an experienced independent power producer or

electric utility, as applicable, willing and able to exert commercially reasonable efforts to achieve such cure within said thirty (30) Day period), then, for so long as the Non-performing Party is making the same effort to cure such breach or default as would be expected of an experienced independent power producer or electric utility, as applicable, willing and able to exert commercially reasonable efforts to achieve such cure, the Non-performing Party shall have a cure period equal to the shorter of (i) the duration of the period within which a cure could reasonably be expected to be achieved by an experienced independent power producer or electric utility, as applicable, willing and able to exert commercially reasonable efforts to achieve such cure or (ii) a period of three hundred sixty five (365) Days beginning on the date of written notice of such breach or default; provided, further, that if the material breach in question involves Seller's failure to meet the operational and performance standards set forth in Attachment B (Seller's Facility), the provisions of Section 1(j) (Demonstration of Facility) for consultant's study and Seller implementation of such study's recommendations shall apply in lieu of the extended cure period provided under the preceding provision.

15.3 Cure/Grace Periods. Before becoming an Event of Default, the occurrences set forth in Section 15.1 (Events of Default by Seller) and Section 15.2 (Events of Default by a Party) are subject to the following cure/grace periods:

- (a) If the occurrence is not the result of Force Majeure, the Non-performing Party shall be entitled to a cure period to the limited extent expressly set forth in the applicable provision of Section 15.1 (Events of Default by Seller) or Section 15.2 (Events of Default by a Party); or
- (b) If the occurrence is the result of Force Majeure, and if and so long as the conditions set forth in Section 21.4 (Satisfaction of Certain Conditions) are satisfied, the Non-performing Party shall be entitled to a grace period as provided in Section 21.6 (Events of Default), which shall apply in lieu of any cure periods provided in Section 15.1 (Events of Default by Seller) and Section 15.2 (Events of Default by a Party).

- 15.4 Rights of the Non-defaulting Party; Forward Contract. If an Event of Default shall have occurred and be continuing, the Party who is not the Defaulting Party ("Non-defaulting Party") shall have the right (i) to terminate this Agreement by sending written notice to the Defaulting Party as provided in this Section 15.4 (Rights of the Non-defaulting Party; Forward Contract); (ii) to withhold any payments due to the Defaulting Party under this Agreement; (iii) suspend performance; and (iv) exercise any other right or remedy available at law or in equity to the extent permitted under this Agreement. A notice terminating this Agreement pursuant to this Section 15.4 (Rights of the Non-defaulting Party; Forward Contract) shall designate the Day such termination is to be effective which Day shall be no later than thirty (30) Days after such notice is deemed to be received by the Defaulting Party and not earlier than the first to occur of the Day such notice is deemed to be received by the Defaulting Party or the Day following the expiration of any period afforded the Defaulting Party under Section 15.1 (Events of Default by Seller) and Section 15.2 (Events of Default by a Party) to cure the default in question. If the Agreement is terminated by Company because of one or more of the Events of Default by Seller, Company shall have the right, in addition to the rights set forth above in this Section 15.4 (Rights of the Non-defaulting Party; Forward Contract), to collect liquidated damages ("Termination Damages"), in accordance with Article 16 (Damages in the Event of Termination by the Company). Without limitation to the generality of the foregoing provisions of this Section 15.4 (Rights of the Non-Defaulting Party; Forward Contract), the Parties agree that, under 11 U.S.C. §362(b)(6), this Agreement is a "forward contract" and the Company is a "forward contract merchant" such that upon the occurrence of an Event of Default by Seller under Section 5.1 (Events of Default by Seller) or Section 15.2 (Events of Default by a Party), this Agreement may be terminated by Company as provided in this Agreement notwithstanding any bankruptcy petition affecting Seller.
- 15.5 Force Majeure. To the extent a Non-performing Party is entitled to defer certain liabilities pursuant to Article 21 (Force Majeure) of the Agreement, the permitted period of deferral shall be governed by Section 21.6 (Events of Default) in lieu of this Article 15 (Events of Default).
- 15.6 Guaranteed Project Milestones Including Guaranteed Commercial Operations Date. Notwithstanding any other

provision of this Article 15 (Events of Default) to the contrary, any failure of Seller to achieve any of the Guaranteed Project Milestones by the applicable Guaranteed Project Milestones Date, including Commercial Operations by the Guaranteed Commercial Operations Date, shall be governed by Article 13 (Guaranteed Project Milestones Including Commercial Operations) in lieu of this Article 15 (Events of Default).

- 15.7 Equitable Remedies. Seller acknowledges that Company is a public utility and is relying upon Seller's performance of its obligations under this Agreement, and that Company and/or its customers may suffer irreparable injury as a result of the failure of Seller to perform any of such obligations, whether or not such failure constitutes an Event of Default or otherwise gives rise to one or more of the remedies set forth in Section 15.4 (Rights of the Non-defaulting Party; Forward Contract). Accordingly, the remedies set forth in Section 15.4 (Rights of the Non-defaulting Party; Forward Contract) shall not limit or otherwise affect Company's right to seek specific performance injunctions or other available equitable remedies for Seller's failure to perform any of its obligations under this Agreement, irrespective of whether such failure constitutes an Event of Default.

ARTICLE 16
DAMAGES IN THE EVENT OF TERMINATION BY COMPANY

- 16.1 Termination Due to Failure to Meet a Guaranteed Project Milestone Date. If the Agreement is terminated by Company pursuant to Section 13.4 (Damages and Termination), Company shall be entitled to Termination Damages calculated by multiplying the Contract Capacity by \$50/kW.
- 16.2 Termination Due to an Event of Default. If the Agreement is terminated by Company in accordance with this Agreement after the Commercial Operations Date due to an Event of Default where Seller is the Defaulting Party, Company shall be entitled to Termination Damages calculated by multiplying the Contract Capacity by \$75/kW.
- 16.3 Liquidated Damages Appropriate. Each Party agrees and acknowledges that (i) the damages that Company would incur due to early termination of the Agreement pursuant to either Section 13.4 (Damages and Termination) or Section 15.4 (Rights of the Non-defaulting Party; Forward Contract) would be difficult or impossible to calculate with certainty, (ii) the Termination Damages are an appropriate approximation of such damages, and (iii) payment of Termination Damages does not relieve Seller of liability for costs and balances incurred prior to the effective date of such termination. The Termination Damages are the sole and exclusive remedy for Company's losses arising out of the termination of this Agreement. The Termination Damages are not intended to limit Company's rights or remedies, or Seller's liabilities or duties, with respect to losses arising independent of the termination of this Agreement, including, without limitation, Company's right to recover under Section 17.1 (Indemnification of Company).
- 16.4 Consequential Damages. Neither Party shall be liable for damages incurred by the other Party for any loss of profit or revenues, loss of product, loss of use of products or services or associated equipment, interruption of business, cost of capital, downtime costs, increased operating costs, or for any special, consequential, incidental, indirect or punitive damages; provided, however, that nothing in this Section 16.4 (Consequential Damages) shall limit any of (i) the indemnification obligations of either Party under Article 17 (Indemnification) of this Agreement, (ii) the liability of either Party for liquidated damages as set forth in this Agreement, (iii) the liability of either Party

for direct damages for breach of this Agreement as and to the extent such damages have not been liquidated as set forth in this Agreement or (iv) the liability of either Party for gross negligence or intentional misconduct.

ARTICLE 17
INDEMNIFICATION

17.1 Indemnification of Company.

- (a) Indemnification Against Third Party Claims. Seller shall indemnify, defend, and hold harmless Company, its successors, permitted assigns, affiliates, controlling persons, directors, officers, employees, agents, contractors, subcontractors and the employees of any of them (collectively referred to as an "Indemnified Company Party"), from and against any Losses suffered, incurred or sustained by any Indemnified Company Party due to any Claim (whether or not well founded, meritorious or unmeritorious) by a third party not controlled by, or under common ownership and/or control with, Company relating to (i) Seller's development, permitting, construction, ownership, operation and/or maintenance of the Facility or (ii) any actual or alleged personal injury or death or damage to property, in any way arising out of, incident to, or resulting directly or indirectly from the acts or omissions of any Indemnified Seller Party, except as and to the extent that such Loss is attributable to the gross negligence or willful misconduct of an Indemnified Company Party.
- (b) Compliance with Laws. Any Losses incurred by an Indemnified Seller Party for noncompliance by Seller or an Indemnified Seller Party with applicable Laws shall not be reimbursed by Company but shall be the sole responsibility of Seller. Seller shall indemnify, defend and hold harmless each Indemnified Company Party from and against any and all Losses in any way arising out of, incident to, or resulting directly or indirectly from the failure of Seller to comply with any Laws.
- (c) Notice. If Seller shall obtain knowledge of any Claim subject to Section 17.1(a) (Indemnification Against Third Party Claims), Section 17.1(b) (Compliance with Laws) or otherwise under this Agreement, Seller shall give prompt notice thereof to Company, and if Company shall obtain any such knowledge, Company shall give prompt notice thereof to Seller.
- (d) Indemnification Procedures.

- (1) In case any Claim subject to Section 17.1(a) (Indemnification Against Third Party Claims) or Section 17.1(b) (Compliance with Laws) or otherwise under this Agreement, shall be brought against an Indemnified Company Party, Company shall notify Seller of the commencement thereof and, provided that Seller has acknowledged in writing to Company its obligation to an Indemnified Company Party under this Section 17.1 (Indemnification of Company), Seller shall be entitled, at its own expense, acting through counsel acceptable to Company, to participate in and, to the extent that Seller desires, to assume and control the defense thereof; provided, however, that Seller shall not compromise or settle a Claim against an Indemnified Company Party without the prior written consent of Company which consent shall not be unreasonably withheld.
- (2) Seller shall not be entitled to assume and control the defense of any such Claim subject to Section 17.1(a) (Indemnification Against Third Party Claims), Section 17.1(b) (Compliance with Laws) or otherwise under this Agreement, if and to the extent that, in the sole opinion of Company, such Claim involves the potential imposition of criminal liability on an Indemnified Company Party or a conflict of interest between an Indemnified Company Party and Seller, in which case Company shall be entitled, at its own expense, acting through counsel acceptable to Seller to participate in any Claim, the defense of which has been assumed by Seller. Company shall supply Seller with such information and documents requested by Seller as are necessary or advisable for Seller to possess in connection with its participation in any Claim to the extent permitted by this Section 17.1(d)(2). An Indemnified Company Party shall not enter into any settlement or other compromise with respect to any Claim without the prior written consent of Seller, which consent shall not be unreasonably withheld or delayed.
- (3) Upon payment of any Losses by Seller, pursuant to this Section 17.1 (Indemnification of Company) or other similar indemnity provisions contained herein, to or on behalf of Company, Seller, without

any further action, shall be subrogated to any and all claims that an Indemnified Company Party may have relating thereto.

- (4) Company shall fully cooperate and cause all Company Indemnified Parties to fully cooperate, in the defense of or response to, any Claim subject to Section 17.1 (Indemnification of Company).

17.2 Indemnification of Seller.

- (a) Indemnification Against Third Party Claims. Company shall indemnify, defend, and hold harmless Seller, its successors, permitted assigns, affiliates, controlling persons, directors, officers, employees, servants and agents, contractors, subcontractors and the employees of any of them (collectively referred to as an "Indemnified Seller Party"), from and against any Losses suffered, incurred or sustained by any Indemnified Seller Party due to any Claim by a third party not controlled by or under common ownership and/or control with Seller (whether or not well founded, meritorious or unmeritorious) relating to any actual or alleged personal injury or death or damage to property, in any way arising out of, incident to, or resulting directly or indirectly from the acts or omissions of any Indemnified Company Party, except to the extent that any such Loss is attributable to the gross negligence or willful misconduct of an Indemnified Seller Party.
- (b) Notice. If Company shall obtain knowledge of any Claim subject to Section 17.2(a) (Indemnification Against Third Party Claims) or otherwise under this Agreement, Company shall give prompt notice thereof to Seller, and if Seller shall obtain any such knowledge, Seller shall give prompt notice thereof to Company.
- (c) Indemnification Procedures.
- (1) In case any action, suit or proceeding subject to Section 17.2(a) (Indemnification Against Third Party Claims), or otherwise under this Agreement, shall be brought against an Indemnified Seller Party, Seller shall notify Company of the commencement thereof and, provided that Company has acknowledged in writing to Seller its obligation to an Indemnified Seller Party under this Section 17.2

(Indemnification of Seller), Company shall be entitled, at its own expense, acting through counsel acceptable to Seller, to participate in and, to the extent that Company desires, to assume and control the defense thereof; provided, however, that Company shall not compromise or settle a Claim against an Indemnified Seller Party without the prior written consent of Seller which consent shall not be unreasonably withheld.

- (2) Company shall not be entitled to assume and control the defense of any such Claim subject to Section 17.2(a) (Indemnification Against Third Party Claims), or otherwise under this Agreement, if and to the extent that, in the opinion of Seller, such Claim involves the potential imposition of criminal liability on an Indemnified Seller Party or a conflict of interest between an Indemnified Seller Party and Company, in which case Seller shall be entitled, at its own expense, acting through counsel acceptable to Company, to participate in any Claim the defense of which has been assumed by Company. An Indemnified Seller Party shall supply Company with such information and documents requested by Company as are necessary or advisable for Company to possess in connection with its participation in any Claim, to the extent permitted by this Section 17.2(c)(2). An Indemnified Seller Party shall not enter into any settlement or other compromise with respect to any Claim without the prior written consent of Company, which consent shall not be unreasonably withheld or delayed.
- (3) Upon payment of any Losses by Company pursuant to this Section 17.2 (Indemnification of Seller) or other similar indemnity provisions contained herein to or on behalf of Seller, Company, without any further action, shall be subrogated to any and all claims that an Indemnified Seller Party may have relating thereto.
- (4) Seller shall fully cooperate and cause all Seller Indemnified Parties to fully cooperate, in the defense of, or response to, any Claim subject to Section 17.2 (Indemnification of Seller).

ARTICLE 18
INSURANCE

- 18.1 Required Coverage. Seller, and anyone acting under its direction or control or on its behalf, shall, at its own expense, acquire and maintain, or cause to be maintained in full effect, commencing with the start of construction of the Facility, as applicable, and continuing throughout the Term, as applicable, the minimum insurance coverage set forth in Attachment R (Required Insurance), or such higher amounts as the Seller and/or the Facility Lender reasonably determines to be necessary during construction and operation of the Facility. Seller's indemnity and other obligations shall not be limited by the foregoing insurance requirements. Any deductible shall be the responsibility of Seller.
- 18.2 Waiver of Subrogation. Seller, and anyone acting under its direction or control or on its behalf, shall cause its insurers to waive all rights of subrogation which Seller or its insurers may have against Company, Company's agents, or Company's employees.
- 18.3 Additional Insureds. The insurance policies specified in Section 2 (General Liability Insurance) and Section 3 (Automobile Liability Insurance) of Attachment R (Required Insurance) shall name Company as an additional insured, as its interests may appear, with respect to any and all third party bodily injury and/or property damage claims, including completed operations, arising from Seller's performance of this Agreement, and Seller shall submit to Company a copy of such additional insured endorsement with evidence of insurance as required herein. The insurance policies specified in Section 4 (Builders All Risk Insurance) and Section 5 (All Risk Property/Comprehensive Boiler and Machinery Insurance (Upon Completion of Construction)) of Attachment R (Required Insurance) shall include Company as loss payee, as its interest may appear with respect to any Property or Boiler and Machinery losses. Seller shall immediately provide written notice to Company should any of the insurance policies required under this Agreement be cancelled, materially modified, or not renewed upon expiration. Company acknowledges that the Facility Lender shall be entitled to receive and distribute any and all loss proceeds as stipulated by any Financing Documents related to any policy described in this Article 18 (Insurance) and Attachment R (Required Insurance).

- 18.4 Evidence of Policies Provided to Company. Evidence of insurance for the coverage specified in this Article 18 (Insurance) shall be provided to Company within thirty (30) Days after the Effective Date or prior to the start of construction, whichever shall first occur. Within 30 Days of any change of any policy and upon renewal of any policy, Seller shall provide certificates of insurance to Company. During the Term, Seller, upon Company's reasonable request, shall make available to Company for its inspection at Seller's designated location, certified copies of the insurance policies described in this Article 18 (Insurance) and Attachment R (Required Insurance). Receipt of any evidence of insurance showing less coverage than requested is not a waiver of Seller's obligations to fulfill the requirements.
- 18.5 Deductibles. Company acknowledges that any policy required herein may contain reasonable deductibles or self-insured retentions, the amounts of which will be reviewed for acceptance by Company. Acceptance will not be unreasonably withheld.
- 18.6 Application of Proceeds from All Risk Property/Comprehensive Boiler and Machinery Insurance. Seller shall use commercially reasonable efforts to obtain provisions in the Financing Documents, on reasonable terms, providing for the insurance proceeds from All Risk Property/Comprehensive Boiler and Machinery Insurance to be applied to repair of the Facility.
- 18.7 Annual Review by Company. The coverage limits shall be reviewed annually by Company and if, in Company's discretion, Company determines that the coverage limits should be increased, Company shall so notify Seller. Seller shall, within thirty (30) Days of notice from Company, increase the coverage as directed in such notice and the costs of such increased coverage limits shall be borne by Seller.
- 18.8 No Representation of Coverage Adequacy. By requiring insurance herein, Company does not represent that coverage and limits will necessarily be adequate to protect Seller, and such coverage and limits shall not be deemed as a limitation on Seller's liability under the indemnities granted to Company in this Agreement.
- 18.9 General Insurance Requirements.

- (a) Each policy shall be specifically endorsed by blanket or otherwise to provide that Seller's insurance is primary. Any other insurance carried by Company will be excess only and not contribute with this insurance.
- (b) Each policy is to be written by an insurer with a rating by A.M. Best Company, Inc. of "A-VII" or better.
- (c) If the limits of available liability coverage required herein become substantially reduced as a result of claim payments, Seller shall immediately, at its own expense, purchase additional liability insurance (if such coverage is available at commercially reasonable rates) to increase the amount of available coverage to the limits of liability coverage required herein.

ARTICLE 19
TRANSFERS, ASSIGNMENTS, AND FACILITY DEBT

- 19.1 Sale of the Facility. Seller shall comply with the requirements of Attachment P (Sale of Facility by Seller) before (i) Seller's right, title or interest in the Facility, in whole or in part, may be disposed of, or (ii) any Ownership Interest is disposed of, or any change in Ownership Control occurs. Any attempt by Seller to make any such disposition or change in control without fulfilling the requirements of Attachment P (Sale of Facility by Seller) shall be deemed null and void and shall constitute an Event of Default pursuant to Article 15 (Events of Default).
- 19.2 Assignment by Seller. Seller may not assign, pledge, mortgage, grant a security interest in or collaterally assign this Agreement, the Facility or any interest in the Facility (including any Ownership Interest or Ownership Control) without the prior consent of Company (such consent not to be unreasonably withheld, conditioned or delayed), provided that Seller shall have the right, without the consent of Company to assign its interest in this Agreement to a wholly-owned subsidiary or to an affiliated company under common control with _____, provided that such assignment does not impair the ability of Seller to perform its obligations under this Agreement.
- 19.3 Company's Acknowledgment. In connection with any assignment relating to the Facility Debt to which Company consents pursuant to Section 19.2 (Assignment by Seller), Company shall, if requested by Seller and if its costs (including reasonable attorneys' fees of outside counsel) in responding to such request are paid by Seller: (i) execute such Hawai'i-law-governed documents as may be reasonably requested by the Facility Lender to acknowledge such assignment and/or pledge/mortgage and the right of the Facility Lender to (aa) receive copies of notices of Events of Default where the Seller is the Defaulting Party and (bb) have reasonable opportunity to cure such Events of Default and to exercise remedies to assume Seller's obligations under this Agreement; and (ii) provide a legal opinion as to the due authorization of such Company acknowledgment.
- 19.4 Financing Document Requirements. In connection with any Facility Debt to which Company consents pursuant to Section 19.2 (Assignment by Seller), Seller shall use commercially reasonable efforts to obtain Financing Documents in a form

reasonably satisfactory to Company which contain the following provisions for Company's benefit:

- (a) Each Facility Lender shall make a binding commitment to Company, in a manner legally enforceable by Company, that so long as this Agreement is in effect and there shall not exist and remain continuing any Event of Default by Company, such Facility Lender will take no action (except pursuant to rights granted to Seller under this Agreement) to disturb, affect or impair Company's rights under this Agreement, including without limitation its rights to dispatch the Facility, nor to terminate or otherwise adversely affect this Agreement, by means of (i) the exercise of any of its rights and remedies of foreclosure or sale afforded by the terms of the Financing Documents or by law in respect of the Facility; or (ii) any other suit, action or proceeding upon the Financing Documents or the exercise of any other rights of such Facility Lender pursuant to any other documents or as a matter of law.
- (b) Each Facility Lender shall agree: (i) to give written notice to Company of any event of default by Seller and any event known to such Facility Lender which, with notice or the passage of time or both, would constitute an event of default by Seller, under any Financing Documents; and (ii) to afford Company the right to cure any such event of default within sixty (60) Days after notice to Company of such event of default, and to forbear from exercising any right or remedy available to such Facility Lender in respect of such event of default during such cure period.
- (c) Each Facility Lender shall agree that in the event of default by Seller under any Financing Documents, Company shall have the option in Company's sole discretion to (i) cure Seller's default without assuming Seller's obligations under the Financing Documents; or (ii) cure Seller's default and directly or by an affiliate assume Seller's obligations under the Financing Documents.

19.5 Grant of Security Interest. In the event that the Facility Debt requires the grant of a security interest (including a mortgage) in this Agreement and/or the Facility, Seller shall provide Company with summaries of the material terms

of the Financing Documents, amendments or modifications thereto, and copies of the Financing Documents. Such summaries and documents shall be provided to Company prior to Seller consummating the financing or refinancing to allow for a reasonable amount of time for Company to review such summaries and documents. The terms and conditions of such financing and refinancing shall be subject to Company's review and consent, which shall not be unreasonably withheld or delayed.

- 19.6 Reimbursement of Company Costs. Seller shall reimburse Company for costs and expenses incurred by Company (including reasonable attorneys' fees of outside counsel) in responding to Facility Lender's requests or as a result of any event of default by Seller under the Financing Documents, including but not limited to any attempt to cure such event of default undertaken by Company as provided in Section 19.4(b) and Section 19.4(c) or any assumption of Seller's obligations under Section 19.4(c).
- 19.7 Assignment By Company. This Agreement shall not be assigned by Company without the prior written consent of Seller (which consent shall not be unreasonably withheld, conditioned or delayed); provided, however, that Company shall have the right, without the consent of Seller, to assign its interest in this Agreement to any affiliated company owned in whole or in part by Hawaiian Electric Industries, Inc.; provided, further, that such assignment does not impair the ability of Seller to continue to receive the payments it is entitled to under this Agreement.
- 19.8 Consequences for Failure to Comply. Any attempt to make any pledge, mortgage, grant of a security interest or collateral assignment for which consent is required under Section 19.2 (Assignment by Seller) or Section 19.7 (Assignment By Company) (as applicable), without fulfilling the requirements of this Article 19 (Transfers, Assignments, and Facility Debt) shall be null and void and shall constitute an Event of Default pursuant to Article 15 (Events of Default).

ARTICLE 20
SALE OF ENERGY TO THIRD PARTIES

Seller shall not sell energy from the Facility to any Third Party.

ARTICLE 21
FORCE MAJEURE

21.1 Definition of Force Majeure. The term "Force Majeure", as used in this Agreement, means any occurrence that:

- (a) In whole or in part delays or prevents a Party's performance under this Agreement;
- (b) Is not the direct or indirect result of the fault or negligence of that Party;
- (c) Is not within the control of that Party notwithstanding such Party having taken all reasonable precautions and measures in order to prevent or avoid such event; and
- (d) The Party has been unable to overcome by the exercise of due diligence.

21.2 Events That Could Qualify as Force Majeure. Subject to the foregoing, events that could qualify as Force Majeure include, but are not limited to, the following:

- (a) acts of God, flooding, lightning, landslide, earthquake, fire, drought, explosion, epidemic, quarantine, storm, hurricane, tornado, volcano, other natural disaster or unusual or extreme adverse weather-related events;
- (b) war (declared or undeclared), riot or similar civil disturbance, acts of the public enemy (including acts of terrorism), sabotage, blockade, insurrection, revolution, expropriation or confiscation; or
- (c) except as set forth in Section 21.3(j) (Exclusions from Force Majeure), strikes, work stoppage or other labor disputes (in which case the affected Party shall have no obligation to settle the strike or labor dispute on terms it deems unreasonable).

21.3 Exclusions From Force Majeure. Force Majeure does not include:

- (a) any acts or omissions of any Third Party, including, without limitation, any vendor, materialman, customer, or supplier of Seller, unless such acts or omissions are themselves excused by reason of Force Majeure;

- (b) any full or partial reduction in the electric output of Facility that is caused by or arises from (i) a mechanical or equipment breakdown or (ii) other mishap or events or conditions attributable to normal wear and tear or defects, unless such mishap is caused by Force Majeure;
- (c) changes in market conditions that affect the cost of Seller's supplies, or that affect demand or price for any of Seller's products, or that otherwise render this Agreement uneconomic or unprofitable for Seller;
- (d) Seller's inability to obtain Governmental Approvals or Land Rights for the construction, ownership, operation and maintenance of Facility and the Company-Owned Interconnection Facilities, or Seller's loss of any such Governmental Approvals or Land Rights once obtained;
- (e) the lack of wind, sun or any other resource of an inherently intermittent nature;
- (f) Seller's inability to obtain sufficient fuel, power or materials to operate its Facility, except if Seller's inability to obtain sufficient fuel, power or materials is caused solely by an event of Force Majeure;
- (g) Seller's failure to obtain additional funds, including funds authorized by a state or the federal government or agencies thereof, to supplement the payments made by Company pursuant to this Agreement;
- (h) a Forced Outage except where such Forced Outage is caused by an event of Force Majeure;
- (i) litigation or administrative or judicial action pertaining to the Agreement, the Site, the Facility, the Land Rights, the acquisition, maintenance or renewal of financing or any Governmental Approvals, or the design, construction, ownership, operation or maintenance of the Facility, the Company-Owned Interconnection Facilities or the Company System;
- (j) a strike, work stoppage or labor dispute limited only to any one or more of the Indemnified Seller Parties

or any other third party employed by Seller to work on the Project; or

- (k) any full or partial reduction in the availability of the Facility to produce and deliver to the Point of Interconnection electric energy in response to Company Dispatch which is caused by any Third Party including, without limitation, any vendor or supplier of Seller or Company, except to the extent due to Force Majeure.

21.4 Satisfaction of Certain Conditions. Section 21.5 (Guaranteed Project Milestones Including Commercial Operations), Section 21.6 (Events of Default) and Section 21.7 (Effect of Force Majeure) defer or limit certain liabilities of a Party for delay and/or failure in performance to the extent such delay or failure is the result of conditions or events of Force Majeure; provided, however, that a Non-performing Party is only entitled to such limitations or deferrals of liabilities as and to the extent the following conditions are satisfied:

- (a) the Non-performing Party gives the other Party, within 48 hours after the Force Majeure condition or event begins, written notice stating that the Non-performing Party considers such condition or event to constitute Force Majeure and describing the particulars of such Force Majeure condition or event;
- (b) the Non-performing Party gives the other Party, within 14 Days after the Force Majeure condition or event begins, a written explanation of the Force Majeure condition or event and its effect on the Non-performing Party's performance, which explanation shall include evidence reasonably sufficient to establish that the occurrence constitutes Force Majeure;
- (c) the suspension of performance is of no greater scope and of no longer duration than is required by the condition or event of Force Majeure;
- (d) the Non-performing Party proceeds with reasonable diligence to remedy its inability to perform and provides written weekly progress reports to the other Party describing actions taken to end the Force Majeure; and

(e) when the condition or event of Force Majeure ends and the Non-performing Party is able to resume performance of its obligations under this Agreement, that Party shall give the other Party written notice to that effect.

21.5 Guaranteed Project Milestones Including Commercial Operations. A condition or event of Force Majeure affecting the achievement of a Guaranteed Project Milestone Date, including the Guaranteed Commercial Operations Date, if and for so long as the conditions of Section 21.4 (Satisfaction of Certain Conditions) are satisfied, shall have the following effect: i) Company shall have the right to collect and Seller shall have the obligation to pay Daily Delay Damages as and to the extent set forth in Section 13.4(a) (Daily Delay Damages); (ii) Company shall have the right to terminate this Agreement as and to the extent set forth in Section 13.4(b) (Termination and Termination Damages for Failure to Achieve a Guaranteed Project Milestone Date); and (iii) notwithstanding any provision herein to the contrary, upon Company's termination of this Agreement pursuant to Section 13.4(b) (Termination and Termination Damages for Failure to Achieve Guaranteed Project Milestone Date) neither Party shall be liable for any damages (including Termination Damages) nor have any obligations to the other, except as provided in Section 29.24 (Survival of Obligations), other than as provided in Section 29.24(b).

21.6 Events of Default. If Force Majeure delays or prevents a Party's performance for more than three hundred sixty-five (365) Days from the occurrence or inception of the Force Majeure, as noticed pursuant to Section 21.4(A), and such delay or failure of performance constitutes an Event of Default under Article 15 (Event of Default), the other Party shall have the right to terminate this Agreement by written notice. Such notice shall designate the date such termination is to be effective, which date shall be no later than thirty (30) Days after such notice is deemed to be received by the Party whose performance has been delayed or prevented. In the event of termination pursuant to this Section 21.6 (Events of Default), neither Party shall be liable for any damages or have any obligations to the other, except as provided in Section 29.25 (Survival of Obligations) other than as provided in Section 29.25(b).

21.7 Effect of Force Majeure. Other than as provided in Section 21.5 (Guaranteed Project Milestones Including Commercial

Operations) and Section 21.6 (Events of Default), neither Party shall be responsible or liable for any delays or failures in its performance under this Agreement as and to the extent (i) such delays or failures are substantially caused by conditions or events of Force Majeure, and (ii) the conditions of Section 21.4 (Satisfaction of Certain Conditions) are satisfied.

- 21.8 No Relief of Other Obligations. Except as otherwise expressly provided for in this Agreement, the existence of a condition or event of Force Majeure shall not relieve the Parties of their obligations under this Agreement (including, but not limited to, payment obligations) to the extent that performance of such obligations is not precluded by the condition or event of Force Majeure.
- 21.9 No Extension of the Term. In no event will any delay or failure of performance caused by any conditions or events of Force Majeure extend this Agreement beyond its stated Term.

ARTICLE 22
WARRANTIES AND REPRESENTATIONS

22.1 By the Parties. Both Company and Seller represent, warrant, and covenant, as of the Execution Date and for the extent of the Term, respectively, that:

- (a) Each respective Party has all necessary right, power and authority to execute, deliver and perform this Agreement
- (b) The execution, delivery and performance of this Agreement by each respective Party will not result in a violation of any Laws, or conflict with, or result in a breach of, or cause a default under, any agreement or instrument to which such Party is also a party or by which it is bound. No consent of any person or entity not a Party to this Agreement, including any Governmental Authority (other than the PUC and other agencies whose approval is necessary for construction of Company-Owned Interconnection Facilities), is required for such execution, delivery and performance by either Party.

22.2 By Seller. Seller represents, warrants, and covenants, as of the Execution Date and for the extent of the Term, that:

- (a) It is an entity in good standing with the Hawai'i Department of Commerce and Consumer Affairs and shall provide Company with a certified copy of a certificate of good standing by the Execution Date.
- (b) **[DRAFTING NOTE: ADD STATEMENT OF SELLER'S EXPERIENCE CONSISTENT WITH STATEMENTS MADE IN SELLER'S PROPOSAL IF APPLICABLE.]**
- (c) As of the Execution Date, Seller has obtained all Land Rights necessary for the construction, ownership, operation and maintenance of the Facility during the Initial Term, and Seller shall maintain such Land Rights in effect throughout the Term.
- (d) As of the commencement of construction, Seller shall have obtained (i) all Land Rights and Governmental Approvals necessary for the construction, ownership, operation and maintenance of the Company-Owned Interconnection Facilities and (ii) all Governmental

Approvals necessary for the construction, ownership, operation and maintenance of the Facility.

- (e) As of the Commercial Operations Date, the Facility will be a qualified renewable resource under RPS in effect as of the Effective Date.

ARTICLE 23
PROCESS FOR ADDRESSING
REVISIONS TO PERFORMANCE STANDARDS

- 23.1 Revisions to Performance Standards. The Parties acknowledge that, during the Term, certain Performance Standards may be revised or added to facilitate necessary improvements in integrating intermittent renewable energy resources into the Company System and operations. In particular, the following Performance Standards in Attachment B (Facility Owned by Seller) to this Agreement may be revised: Section 3(c) (Ramp Rates); and Section 3(m) (Frequency Response). Such revisions or additions may be attributable to, without limitation, the following: changes in penetration levels of intermittent renewable resources on the Company System, changes to the state of commercially available technology, changes to Company-owned generation resources, changes in customer electrical usage (such as changes in average hourly load profiles), and changes in Laws (e.g., new environmental constraints, which may limit Company's ability to start/stop its generators in response to integration of intermittent generation, or constraints impacting the power quality standards for the Company System, such as constraints imposed by HERA or by the PUC under the HERA Law).
- 23.2 Performance Standards Information Request. If Company concludes that a Performance Standards Revision is necessary or important for the operation of the Company System and is capable of being complied with by Seller, Company shall have the right to issue to Seller a Performance Standards Information Request with respect to such Performance Standards Revision. Seller shall, within a reasonable period of time following Seller's receipt of such Performance Standards Information Request, but in no event more than 90 Days after Seller's receipt of such Request (or such other period of time as Company and Seller may agree in writing), submit to Company a Performance Standards Proposal responsive to the Performance Standards Revision proposed in such Performance Standards Information Request.
- 23.3 Performance Standards Proposal. Upon receipt of a Performance Standards Proposal submitted in response to a Performance Standards Information Request, Company will evaluate such Performance Standards Proposal and Seller shall assist Company in performing such evaluation as and to the extent reasonably requested by Company (including, but not limited to, providing such additional information as

Company may reasonably request and participating in meetings with Company as Company may reasonably request). Company shall have no obligation to evaluate a Performance Standards Proposal submitted at Seller's own initiative.

23.4 Performance Standards Revision Document. If, following Company's evaluation of a Performance Standards Proposal, Company desires to consider implementing the Performance Standards Revision addressed in such Proposal, Company shall provide Seller with written notice to that effect, such notice to be issued to Seller within 180 Days of receipt of the Performance Standards Proposal, and Company and Seller shall proceed to negotiate in good faith a Performance Standards Revision Document setting forth the specific changes to the Agreement that are necessary to implement such Performance Standards Revision. A decision by Company to initiate negotiations with Seller as aforesaid shall not constitute an acceptance by Company of any of the details set forth in Seller's Performance Standards Proposal for the Performance Standards Revision in question, including but not limited to the Performance Standards Modifications and the Performance Standards Pricing Impact. Any adjustment to the Contract Pricing pursuant to such Performance Standards Revision Document shall be limited to the Performance Standards Pricing Impact (other than with respect to the financial consequences of non-performance as to a Performance Standards Revision). The time periods set forth in such Performance Standards Revision Document as to the effective date for the Performance Standards Revision shall be measured from the date the PUC Performance Standards Revision Order becomes non-appealable as provided in Section 23.6 (PUC Performance Standards Revision Order).

23.5 Failure to Reach Agreement. If Company and Seller are unable to agree upon and execute a Performance Standards Revision Document within 180 Days of Company's written notice to Seller pursuant to Section 23.4 (Performance Standards Revision Document), Company shall have the option of declaring the failure to reach agreement on and execute such Performance Standards Revision Document to be a dispute and submit such dispute to an Independent Evaluator for the conduct of a determination pursuant to Section 23.10 (Dispute) of this Agreement. Any decision of the Independent Evaluator, rendered as a result of such dispute shall include a form of a Performance Standards Revision Document as described in Section 23.4 (Performance Standards Revision Document).

- 23.6 PUC Performance Standards Revision Order. No Performance Standards Revision Document shall constitute an amendment to the Agreement unless and until a PUC Performance Standards Revision Order issued with respect to such Document has become non-appealable. Once the condition of the preceding sentence has been satisfied, such Performance Standards Revision Document shall constitute an amendment to this Agreement. To be "non-appealable" under this Section 23.6 (PUC Performance Standards Revision Order), such PUC Performance Standards Revision Order shall be either (i) not subject to appeal to any Circuit Court of the State of Hawai'i or the Supreme Court of the State of Hawai'i, because the thirty (30) Day period (accounting for weekends and holidays as appropriate) permitted for such an appeal has passed without the filing of notice of such an appeal, or (ii) affirmed on appeal to any Circuit Court of the State of Hawai'i or the Supreme Court, or the Intermediate Appellate Court upon assignment by the Supreme Court, of the State of Hawai'i, or affirmed upon further appeal or appellate process, and is not subject to further appeal, because the jurisdictional time permitted for such an appeal (and/or further appellate process such as a motion for reconsideration or an application for writ of certiorari) has passed without the filing of notice of such an appeal (or the filing for further appellate process).
- 23.7 Company's Rights. The rights granted to Company under Section 23.4 (Performance Standards Revision Document) and Section 23.5 (Failure to Reach Agreement) above are exclusive to Company. Seller shall not have a right to initiate negotiations of a Performance Standards Revision Document or to initiate dispute resolution under Section 23.10 (Dispute), as a result of a failure to agree upon and execute any Performance Standards Revision Document.
- 23.8 Seller's Obligation. Notwithstanding any provision of this Article 23 (Process for Addressing Revisions to Performance Standards) to the contrary, Seller shall have no obligation to respond to more than one Performance Standards Information Request during any 12-month period.
- 23.9 Limited Purpose. This Article 23 (Process for Addressing Revisions to Performance Standards) is intended to specifically address necessary revisions to the Performance Standards to enhance integration of intermittent resources onto Company System, or to comply with future Laws which may be driven in part by higher integration of intermittent

resources, and is not intended for either Party to provide a means for renegotiating any other terms of this Agreement. Revisions to the Performance Standards in accordance with the provisions of this Article 23 (Process for Addressing Revisions to Performance Standards) are not intended to materially increase Seller's risk of non-performance or default.

23.10 Dispute. If Company decides to declare a dispute as a result of the failure to reach agreement and execute a Performance Standards Revision Document pursuant to Section 23.5 (Failure to Reach Agreement), it shall provide written notice to that effect to Seller. Within 20 Days of delivery of such notice Seller and Company shall agree upon an Independent Evaluator to resolve the dispute regarding a Performance Standards Revision Document. The Independent Evaluator shall be reasonably qualified and expert in renewable energy power generation, matters relating to the Performance Standards, financing, and power purchase agreements. If the Parties are unable to agree upon an Independent Evaluator within such 20-Day period, Company shall apply to the PUC for the appointment of an Independent Evaluator. If an Independent Observer retained under the Competitive Bidding Framework is qualified and willing and available to serve as Independent Evaluator, the PUC shall appoint one of the persons or entities qualified to serve as an Independent Observer to be the Independent Evaluator; if not, the PUC shall appoint another qualified person or entity to serve as Independent Evaluator. In its application, Company shall ask the PUC to appoint an Independent Evaluator within 30 Days of the application.

(a) Promptly upon appointment, the Independent Evaluator shall request the Parties to address the following matters within the next 15 Days:

- (1) The Performance Standard Revision(s);
- (2) The technical feasibility of complying with the Performance Standard Revision(s) and likelihood of compliance;
- (3) How Seller would comply with the Performance Standard Revision(s);

- (4) Reasonably expected net costs and/or lost revenues associated with the Performance Standards Revision(s);
 - (5) The appropriate level, if any, of Performance Standards Pricing Impact in light of the foregoing; and
 - (6) Contractual consequences for non-performance that are commercially reasonable under the circumstances.
- (b) Within 90 Days of appointment, the Independent Evaluator shall render a decision unless the Independent Evaluator determines it needs to have additional time, not to exceed 45 Days, to render a decision.
 - (c) The Parties shall assist the Independent Evaluator throughout the process of preparing its review, including making key personnel and records available to the Independent Evaluator, but neither Party shall be entitled to participate in any meetings with personnel of the other Party or review of the other Party's records. However, the Independent Evaluator will have the right to conduct meetings, hearings or oral arguments in which both Parties are represented. The Parties may meet with each other during the review process to explore means of resolving the matter on mutually acceptable terms.
 - (d) The following standards shall be applied by the Independent Evaluator in rendering his or her decision: (i) if it is not technically or operationally feasible for Seller to comply with a Performance Standard Revision, the Independent Evaluator shall determine that the Agreement shall not be amended to incorporate such Performance Standard Revision (unless the Parties agree otherwise); (ii) if it is technically or operationally feasible for Seller to comply with a Performance Standard Revision, the Independent Evaluator shall incorporate such Performance Standard Revision into a Performance Standards Revision Document including (aa) Seller's Performance Standards Modifications, (bb) pricing terms that incorporate the Performance Standards Pricing Impact, and (cc) contract terms and conditions

that are commercially reasonable under the circumstances, especially with respect to the consequences of non-performance by Seller as to Performance Standards Revision(s). In addition to the Performance Standards Revision Document, the Independent Evaluator shall render a decision which sets forth the positions of the Parties and Independent Evaluator's rationale for his or her decisions on disputed issues.

- (e) The fees and costs of the Independent Evaluator shall be paid by Company up to the first \$30,000 of such fees and costs; above those amounts, the Party that is not the prevailing Party shall be responsible for any such fees and costs; provided, if neither Party is the prevailing Party, then the fees and costs of the Independent Evaluator above \$30,000, shall be borne equally by the Parties. The Independent Evaluator in rendering his or her decision shall also state which Party prevailed over the other Party, or that neither Party prevailed over the other.

23.11 HERA Law. The provisions of this Article 23 (Process for Addressing Revisions to Performance Standards) are without limitation to the obligations of the Parties under the HERA Law and the reliability standards and interconnection requirements developed and adopted by the PUC pursuant to the HERA Law.

ARTICLE 24
FINANCIAL COMPLIANCE

- 24.1 Financial Compliance. Seller shall provide or cause to be provided to Company on a timely basis, as reasonably determined by Company, all information, including but not limited to information that may be obtained in any audit referred to below (the "Financial Compliance Information"), reasonably requested by Company for purposes of permitting Company and its parent company, HEI, to comply with the requirements (initial and on-going) of (i) the accounting principles of Financial Accounting Standards Board ("FASB") Accounting Standards Codification 810, Consolidation ("FASB ASC 810"), (ii) Section 404 of the Sarbanes-Oxley Act of 2002 ("SOX 404"), (iii) FASB ASC 840 Leases ("FASB ASC 840"), and (iv) all clarifications, interpretations and revisions of and regulations implementing FASB ASC 810, SOX 404 and FASB ASC 840, issued by the FASB, Securities and Exchange Commission, the Public Company Accounting Oversight Board, Emerging Issues Task Force or other Governmental Authorities. In addition, if required by Company in order to meet its compliance obligations, Seller shall allow Company or its independent auditor to audit, to the extent reasonably required, Seller's financial records, including its system of internal controls over financial reporting; provided, however, that Company shall be responsible for all costs associated with the foregoing, including but not limited to Seller's reasonable internal costs. Company shall limit access to such Financial Compliance Information to persons involved with such compliance matters and restrict persons involved in Company's monitoring, dispatch or scheduling of Seller and/or Facility, or the administration of this Agreement, from having access to such Financial Compliance Information (unless approved in writing in advance by Seller).
- 24.2 Confidentiality. Company shall, and shall cause HEI to, maintain the confidentiality of the Financial Compliance Information as provided in this Article 24 (Financial Compliance). Company may share the Information on a confidential basis with HEI and the independent auditors and attorneys for HEI. (Company, HEI, and their respective independent auditors and attorneys are collectively referred to in this Article 24 (Financial Compliance) as "Recipient".) If either Company or HEI, in the exercise of their respective reasonable judgments, concludes that consolidation or financial reporting with respect to Seller

and/or this Agreement is necessary, Company and HEI each shall have the right to disclose such of the Financial Compliance Information as Company or HEI, as applicable, reasonably determines is necessary to satisfy applicable disclosure and reporting or other requirements and give Seller prompt written notice thereof (in advance to the extent practicable under the circumstances). If Company or HEI disclose Financial Compliance Information pursuant to the preceding sentence, Company and HEI shall, without limitation to the generality of the preceding sentence, have the right to disclose Financial Compliance Information to the PUC and the Division of Consumer Advocacy of the Department of Commerce and Consumer Affairs of the State of Hawai'i ("Consumer Advocate") in connection with the PUC's rate making activities for Company and other HEI affiliated entities, provided that, if the scope or content of the Financial Compliance Information to be disclosed to the PUC exceeds or is more detailed than that disclosed pursuant to the preceding sentence, such Financial Compliance Information will not be disclosed until the PUC first issues a protective order to protect the confidentiality of such Financial Compliance Information. Neither Company nor HEI shall use the Financial Compliance Information for any purpose other than as permitted under this Article 24 (Financial Compliance).

- 24.3 Required Disclosure. In circumstances other than those addressed in Section 24.2 (Confidentiality), if any Recipient becomes legally compelled under applicable Laws or by legal process (e.g., deposition, interrogatory, request for documents, subpoena, civil investigative demand or similar process) to disclose all or a portion of the Financial Compliance Information, such Recipient shall undertake reasonable efforts to provide Seller with prompt notice of such legal requirement prior to disclosure so that Seller may seek a protective order or other appropriate remedy and/or waive compliance with the terms of this Article 24 (Financial Compliance). If such protective order or other remedy is not obtained, or if Seller waives compliance with the provisions at this Article 24 (Financial Compliance), Recipient shall furnish only that portion of the Financial Compliance Information which it is legally required to so furnish and to use reasonable efforts to obtain assurance that confidential treatment will be accorded to any disclosed material.

- 24.4 Exclusions from Confidentiality. The obligation of nondisclosure and restricted use imposed on each Recipient under this Article 24 (Financial Compliance) shall not extend to any portion(s) of the Financial Compliance Information which (i) was known to such Recipient prior to receipt, or (ii) without the fault of such Recipient is available or becomes available to the general public, or (iii) is received by such Recipient from a Third Party not bound by an obligation or duty of confidentiality.
- 24.5 Consolidation and Lease. Company does not want to be subject to consolidation and capital lease treatment as set forth in FASB ASC 810 and 840, respectively, as issued and amended from time to time by FASB. Company also does not want to be subject to lease treatment as set forth in FASB Accounting Standards Codification 842, Leases, effective January 1, 2019 ("FASB ASC 842").
- (a) Consolidation. Company represents that, as of the Execution Date, it is not required to consolidate Seller into its financial statements in accordance with FASB ASC 810. If for any reason, at any time during the Term, Company determines, in its sole but good faith discretion, that it is required to consolidate Seller into its financial statements in accordance with FASB ASC 810, then Seller shall immediately provide audited financial statements (including footnotes) in accordance with U.S. generally accepted accounting principles (and as of the reporting periods Company is required to report thereafter) in order for Company to consolidate and file its financial statements within the reporting deadlines of the Securities and Exchange Commission; provided, however, that if Seller does not normally prepare audited financial statements for the periods requested, Company shall reimburse Seller fifty percent (50%) of the reasonable costs of having necessary audits performed and preparation of the audited financial statement; provided, further that the foregoing reimbursement shall only apply if Seller normally prepares financial statements on an annual basis. Notwithstanding the foregoing requirement that Seller provide audited financial statements to Company, the Parties will take all commercially reasonable steps, which may include modification of this Agreement to eliminate the consolidation treatment, while preserving the economic "benefit of

the bargain" to both Parties, or, if the Parties are unable to eliminate the consolidation treatment by other means, effectuating a sale of the Facility to Company at (i) if the sale occurs before the end of the thirteenth (13th) Contract Year, the greater of the Make Whole Amount determined pursuant to Section 6 (Make Whole Amount) of Attachment P (Sale of Facility of Seller) or the fair market value determined pursuant to Section 3 (Procedure to Determine Fair Market Value of the Facility) of Attachment P (Sale of Facility by Seller), or (ii) if the sale occurs on or after the beginning of the fourteenth (14th) Contract Year, the fair market value determined pursuant to Section 3 (Procedure to Determine Fair Market Value of the Facility) of Attachment P (Sale of Facility by Seller), but not less than the Financial Termination Costs determined pursuant to Section 6 (Make Whole Amount) of Attachment P (Sale of Facility by Seller), in either case under a Purchase and Sale Agreement to be negotiated based on the terms and conditions set forth in Section 4 (Purchase and Sale Agreement) of Attachment P (Sale of Facility by Seller).

- (b) Capital Lease. Company represents that, as of the Execution Date, it is not required to treat this Agreement as a capital lease. If there is a change in circumstances during the Term that would trigger capital lease treatment as of the Execution Date, and such capital lease treatment is not attributable to Company's fault, then the Parties will take all commercially reasonable steps, which may include modification of the Agreement to eliminate the capital lease treatment, while preserving the economic "benefit of the bargain" to both Parties, or, if the Parties are unable to eliminate the capital lease treatment by other means, effectuating a sale of the Facility to Company at (i) if the sale occurs before the end of the thirteenth (13th) Contract Year, the greater of the Make Whole Amount determined pursuant to Section 6 (Make Whole Amount) of Attachment P (Sale of Facility of Seller) or the fair market value determined pursuant to Section 3 (Procedure to Determine Fair Market Value of the Facility) of Attachment P (Sale of Facility by Seller) or (ii) if the sale occurs on or after the beginning of the fourteenth (14th) Contract Year, the fair market value determined pursuant to Section 3 (Procedure to

Determine Fair Market Value of the Facility) of Attachment P (Sale of Facility by Seller), but not less than the Financial Termination Costs determined pursuant to Section 6 (Make Whole Amount) of Attachment P (Sale of Facility by Seller), in either case under a Purchase and Sale Agreement to be negotiated based on the terms and conditions set forth in Section 4 (Purchase and Sale Agreement) of Attachment P (Sale of Facility by Seller).

- (c) Lease. Under FASB ASC 842, finance and operating leases will be reflected on the Company's balance sheet. If there is a change in circumstances during the Term that would trigger lease treatment, and such lease treatment is not attributable to Company's fault, then the Parties will take all commercially reasonable steps, which may include modification of the Agreement, to eliminate the lease treatment, while preserving the economic "benefit of the bargain" to both Parties, or, if the Parties are unable to eliminate the lease treatment by other means, effectuating a sale of the Facility to Company at (i) if the sale occurs before the end of the thirteenth (13th) Contract Year, the greater of the Make Whole Amount determined pursuant to Section 6 (Make Whole Amount) of Attachment P (Sale of Facility of Seller) or the fair market value determined pursuant to Section 3 (Procedure to Determine Fair Market Value of the Facility) of Attachment P (Sale of Facility by Seller) or (ii) if the sale occurs on or after the beginning of the fourteenth (14th) Contract Year, the fair market value determined pursuant to Section 3 (Procedure to Determine Fair Market Value of the Facility) of Attachment P (Sale of Facility by Seller), but not less than the Financial Termination Costs determined pursuant to Section 6 (Make Whole Amount) of Attachment P (Sale of Facility by Seller), in either case under a Purchase and Sale Agreement to be negotiated based on the terms and conditions set forth in Section 4 (Purchase and Sale Agreement) of Attachment P (Sale of Facility by Seller).

ARTICLE 25
GOOD ENGINEERING AND OPERATING PRACTICES

- 25.1 General. Each Party agrees to install, operate and maintain its respective equipment and facility and to perform all obligations required to be performed by such Party under this Agreement in accordance with Good Engineering and Operating Practices and applicable Laws.
- 25.2 Specifications, Determinations and Approvals. Wherever in this Agreement Company has the right to give specifications, determinations or approvals, such specifications, determinations or approvals shall be given in accordance with Company's standard practices, policies and procedures and shall not be unreasonably withheld.
- 25.3 No Endorsement, Warranty or Waiver. Any such specifications, determinations, or approvals shall not be deemed to be an endorsement, warranty, or waiver of any right of Company.
- 25.4 Consultants List. Prior to the Commercial Operations Date, the Parties shall agree on a list of names of engineering firms to be attached as Attachment D (Consultants List) in accordance with Section 4 (Maintenance of Seller-Owned Interconnection Facilities) of Attachment B (Facility Owned By Seller).

ARTICLE 26
EQUAL EMPLOYMENT OPPORTUNITY

- 26.1 Equal Employment Opportunity. (Applicable to all contracts of \$10,000 or more in the whole or aggregate. 41 CFR 60-1.4 and 41 CFR 60-741.5.) Seller is aware of and is fully informed of Seller's responsibilities under Executive Order 11246 (reference to which include amendments and orders superseding in whole or in part) and shall be bound by and agrees to the applicable provisions as contained in Section 202 of said Executive Order and the Equal Opportunity Clause as set forth in 41 CFR 60-1.4 and 41 CFR 60-741.5(a), which clauses are hereby incorporated by reference.
- 26.2 Equal Opportunity For Disabled Veterans, Recently Separated Veterans, Other Protected Veterans and Armed Forces Service Medal Veterans. Applicable to (i) contracts of \$25,000 or more entered into before December 31, 2003 (41 CFR 60-250.4) or (ii) each federal government contract of \$100,000 or more, entered into or modified on or after December 31, 2003 (41 CFR 60-300.4) for the purchase, sale or use of personal property or nonpersonal services (including construction.) If applicable to Seller under this Agreement, Seller agrees that is, and shall remain, in compliance with the rules and regulations promulgated under The Vietnam Era Veterans Readjustment Assistance Act of 1974, as amended by the Jobs for Veterans Act of 2002, including the requirements of 41 CFC 60-250.5(a) (for orders/contracts entered into before December 31, 2003) and 41 CFR 60-300.5(a) (for orders/contracts entered into or modified on or after December 31, 2003) which are incorporated into this Agreement by reference.

ARTICLE 27
SET OFF

Company shall have the right to set off any payment due and owing by Seller, including but not limited to any payment under this Agreement and any payment due under any award made under Article 28 (Dispute Resolution), against Company's payments of subsequent monthly invoices as necessary.

ARTICLE 28
DISPUTE RESOLUTION

- 28.1 Good Faith Negotiations. Except as otherwise expressly set forth in this Agreement, before submitting any claims, controversies or disputes ("Dispute(s)") under this Agreement to the Dispute Resolution Procedures set forth in Section 28.2 (Dispute Resolution Procedures, Mediation), the presidents, vice presidents, or authorized delegates from both Seller and Company having full authority to settle the Dispute(s), shall personally meet in Hawai'i and attempt in good faith to resolve the Dispute(s) (the "Management Meeting").
- 28.2 Dispute Resolutions Procedures, Mediation. Except as otherwise expressly set forth in this Agreement and subject to Section 28.1 (Good Faith Negotiations), any and all Dispute(s) arising out of or relating to this Agreement, (i) which remain unresolved for a period of 20 Days after the Management Meeting takes place or (ii) for which the Parties fail to hold a Management Meeting within 60 Days of the date that a Management Meeting was requested by a Party, may upon the agreement of the Parties, first be submitted to confidential mediation in Honolulu, Hawai'i pursuant to the administration by, and in accordance with the Mediation Rules, Procedures and Protocols of, Dispute Prevention & Resolution, Inc. (or its successor) or, in their absence, the American Arbitration Association ("DPR") then in effect. If the Parties agree to submit the dispute to confidential mediation, the parties shall each pay 50% of the cost of the mediation (i.e., the fees and expenses charged by the mediator and DPR) and shall otherwise each bear their own mediation costs and attorneys' fees. If the Parties do not submit the Dispute(s) to mediation, or if they do submit the Dispute(s) to mediation but settlement of the Dispute(s) is not reached within 60 Days after commencement of the mediation, either Party may initiate legal proceedings in a court of competent jurisdiction in the State of Hawai'i.
- 28.3 Exclusions. The provisions of this Article 28 (Dispute Resolution) shall not apply to any disputes within the authority of any of (i) an Independent Evaluator under Article 23 (Process for Addressing Revisions to Performance Standards), (ii) an Independent PBA Evaluator under Attachment T (Calculation and Reporting of Production Based Availability and Dispute Resolution by Independent Evaluator

of Production-Based Availability) or (iii) an OEPR Evaluator under Attachment U (Calculation and Adjustment of Net Energy Potential).

ARTICLE 29
MISCELLANEOUS

29.1 Amendments. Any amendment or modification of this Agreement or any part hereof shall not be valid unless in writing and signed via manual signature by the Parties. Any waiver hereunder shall not be valid unless in writing and signed via manual signature by the Party against whom waiver is asserted. Notwithstanding the foregoing, administrative changes mutually agreed by Company and Seller in writing, such as changes to settings shown in the Single-Line Drawing and Interface Block Diagram (Attachment E) and the Relay List and Trip Scheme (Attachment F) and changes to numerical values of Performance Standards in Section 3 (Performance Standards) of Attachment B (Facility owned by Company) shall not be considered amendments to this Agreement requiring PUC approval.

29.2 Binding Effect. This Agreement shall be binding upon and inure to the benefit of the Parties hereto and their respective successors, legal representatives, and permitted assigns.

29.3 Notices.

- (a) All notices, consents and waivers under this Agreement shall be in writing and will be deemed to have been duly given when (i) delivered by hand, (ii) sent by electronic mail ("E-mail") (provided receipt thereof is confirmed via E-mail or in writing by recipient), (iii) sent by certified mail, return receipt requested, or (iv) when received by the addressee, if sent by a nationally recognized overnight delivery service (receipt requested), in each case to the appropriate addresses and E-mail Addresses set forth below (or to such other addresses and E-mail addresses as a Party may designate by notice to the other Party):

Company:

By Mail:

Hawaiian Electric Company, Inc.
P.O. Box 2750
Honolulu, Hawai'i 96840
Attn: Director Energy Procurement

Delivered By Hand or Overnight Delivery:

Hawaiian Electric Company, Inc.
Central Pacific Plaza
220 South King Street, Suite 2100
Honolulu, Hawai'i 96813
Attn: Director Energy Procurement

By facsimile-mail:

Hawaiian Electric Company, Inc.
Attn: Director Energy Procurement
Email: ppanotices@hawaiianelectric.com

With a copy to:

By Mail:

Hawaiian Electric Company, Inc.
Legal Department
P.O. Box 2750
Honolulu, Hawai'i 96840

By E-mail:

Hawaiian Electric Company, Inc.
Legal Department
Email: legalnotices@hawaiianelectric.com

Seller: The contact information listed in Attachment A (Description of Generation and Conversion Facility) hereto.

- (b) Notice sent by mail shall be deemed to have been given on the date of actual delivery or at the expiration of the fifth Day after the date of mailing, whichever is earlier. Any Party hereto may change its address for written notice by giving written notice of such change to the other Party hereto.
- (c) Any notice delivered by E-mail shall request a receipt thereof confirmed by E-mail or in writing by the recipient and followed by personal or mail delivery of such correspondence any attachments as may be requested by the recipient, and the effective date of such notice shall be the date of receipt, provided such receipt has been confirmed by the recipient.
- (d) The Parties may agree in writing upon additional means of providing notices, consents and waivers under this Agreement in order to adapt to changing technology and commercial practices.

- 29.4 Effect of Section and Attachment Headings. The Table of Contents and paragraph headings of the various sections and attachments have been inserted in this Agreement as a matter of convenience for reference only and shall not modify, define or limit any of the terms or provisions hereof and shall not be used in the interpretation of any term or provision of this Agreement.
- 29.5 Non-Waiver. Except as otherwise provided in this Agreement, no delay or forbearance of Company or Seller in the exercise of any remedy or right will constitute a waiver thereof, and the exercise or partial exercise of a remedy or right shall not preclude further exercise of the same or any other remedy or right.
- 29.6 Relationship of the Parties. Nothing in this Agreement shall be deemed to constitute either Party hereto as partner, agent or representative of the other Party or to create any fiduciary relationship between the Parties. Seller does not hereby dedicate any part of Facility to serve Company, Company's customers or the public.
- 29.7 Entire Agreement. This Agreement (together with any confidentiality or non-disclosure agreements entered into by the Parties during the process of negotiating this Agreement and/or discussing the specifications of the Facility) constitutes the entire agreement between the Parties relating to the subject matter hereof, superseding all prior agreements, understandings or undertakings, oral or written. Each of the Parties confirms that in entering into this Agreement, it has not relied on any statement, warranty or other representations (other than those set out in this Agreement) made or information supplied by or on behalf of the other Party.
- 29.8 Governing Law, Jurisdiction and Venue. Interpretation and performance of this Agreement shall be in accordance with, and shall be controlled by, the laws of the State of Hawai'i, other than the laws thereof that would require reference to the laws of any other jurisdiction. By entering into this Agreement, Seller submits itself to the personal jurisdiction of the courts of the State of Hawai'i and agrees that the proper venue for any civil action arising out of or relating to this Agreement shall be Honolulu, Hawai'i.
- 29.9 Limitations. Nothing in this Agreement shall limit Company's ability to exercise its rights as specified in

Company's Tariff as filed with the PUC, or as specified in General Order No. 7 of the PUC's Standards for Electric Utility Service in the State of Hawai'i, as either may be amended from time to time.

- 29.10 Further Assurances. If either Party determines in its reasonable discretion that any further instruments, assurances or other things are necessary or desirable to carry out the terms of this Agreement, the other Party will execute and deliver all such instruments and assurances and do all things reasonably necessary or desirable to carry out the terms of this Agreement.
- 29.11 Electronic Signatures and Counterparts. The parties agree that this Agreement and any subsequent writings, including amendments, may be executed and delivered by exchange of executed copies via E-mail or other acceptable electronic means, and in electronic formats such as Adobe PDF or other formats mutually agreeable between the parties which preserve the final terms of this Agreement or such writing. A party's signature transmitted by facsimile, E-mail, or other acceptable electronic means shall be considered an "original" signature which is binding and effective for all purposes of this Agreement. This Agreement may be executed in counterparts, each of which shall be deemed an original, and all of which shall together constitute one and the same instrument binding all Parties notwithstanding that all of the Parties are not signatories to the same counterparts. For all purposes, duplicate unexecuted and unacknowledged pages of the counterparts may be discarded and the remaining pages assembled as one document.
- 29.12 Definitions. Capitalized terms used in this Agreement and not otherwise defined in the context in which they first appear are defined in the Definitions Section.
- 29.13 Severability. If any term or provision of this Agreement, or the application thereof to any person, entity or circumstances is to any extent invalid or unenforceable, the remainder of this Agreement, or the application of such term or provision to persons, entities or circumstances other than those as to which it is invalid or unenforceable, shall not be affected thereby, and each term and provision of this Agreement shall be valid and enforceable to the fullest extent permitted by law, and the Parties will take all commercially reasonable steps, including modification of the Agreement, to preserve the economic "benefit of the bargain"

to both Parties notwithstanding any such aforesaid invalidity or unenforceability.

- 29.14 Settlement of Disputes. Except as otherwise expressly provided, any dispute or difference arising out of this Agreement or concerning the performance or the non-performance by either Party of its obligations under this Agreement shall be determined in accordance with the dispute resolution procedures set forth in Article 28 (Dispute Resolution) of this Agreement.
- 29.15 Environmental Credits and RPS. To the extent not prohibited by law, Company shall have the sole and exclusive right to use the electric energy purchased hereunder to meet RPS and any Environmental Credit shall be the property of Company; provided, however, that such Environmental Credits shall be to the benefit of Company's ratepayers in that the value must be credited "above the line". Seller shall use all commercially reasonable efforts to ensure such Environmental Credits are vested in Company, and shall execute all documents, including, but not limited to, documents transferring such Environmental Credits, without further compensation; provided, however, that Company agrees to pay for all reasonable costs associated with such efforts and/or documentation.
- 29.16 Schedule of Defined Terms and Attachments. The Schedule of Defined Terms and each Attachment to this Agreement constitute essential and necessary parts of this Agreement.
- 29.17 Proprietary Rights. Seller agrees that in fulfilling its responsibilities under this Agreement, it will not use any process, program, design, device or material that infringes on any United States patent, trademark, copyright or trade secret ("Proprietary Rights"). Seller agrees to indemnify, defend and hold harmless the Indemnified Company Party from and against all losses, damages, claims, fees and costs, including but not limited to reasonable attorneys' fees and costs, arising from or incidental to any suit or proceeding brought against the Indemnified Company Party for infringement of Third Party Proprietary Rights arising out of Seller's performance under this Agreement, including but not limited to patent infringement due to the use of technical features of the Facility to meet the Performance Standards specified in the Agreement.
- 29.18 Negotiated Terms. The Parties agree that the terms and conditions of this Agreement are the result of negotiations

between the Parties and that this Agreement shall not be construed in favor of or against any Party by reason of the extent to which any Party or its professional advisors participated in the preparation of this Agreement.

29.19 Computation of Time. In computing any period of time prescribed or allowed under this Agreement, the Day of the act, event or default from which the designated period of time begins to run shall not be included. If the last Day of the period so computed is not a Business Day, then the period shall run until the end of the next Day which is a Business Day.

29.20 PUC Approval.

(a) PUC Approval Order. The term "PUC Approval Order" means an order from the PUC that does not contain terms and conditions deemed to be unacceptable by Company, and is in a form deemed to be reasonable by Company, in its sole, but nonarbitrary, discretion, ordering that:

- (1) this Agreement is approved;
- (2) Company is authorized to include the purchased energy costs (and related revenue taxes) that Company incurs under this Agreement in Company's Energy Cost Adjustment Clause, to the extent such costs are not included in Base Rates for the Term;
- (3) Company is authorized to include the Lump Sum Payment that Company incurs under this Agreement in Company's Purchase Power Adjustment Clause, to the extent such costs are not included in Base Rates for the Term;
- (4) the purchased energy costs and the Lump Sum Payment to be incurred by Company as a result of this Agreement are reasonable; and
- (5) Company's purchased power arrangements under this Agreement, pursuant to which Company will purchase energy and Renewable Dispatchable Generation from Seller, are prudent and in the public interest.

(b) Non-appealable PUC Approval Order. The term "Non-appealable PUC Approval Order" means a PUC Approval Order (i) that is not subject to appeal to any Circuit

Court of the State of Hawai'i, Intermediate Court of Appeals of the State of Hawai'i, or the Supreme Court of the State of Hawai'i, because the period permitted for such an appeal (the "Appeal Period") has passed without the filing of notice of such an appeal, or (ii) that was affirmed on appeal to any Circuit Court of the State of Hawai'i, Intermediate Court of Appeals of the State of Hawai'i, or the Supreme Court of the State of Hawai'i, or was affirmed upon further appeal or appellate process, and that is not subject to further appeal, because the jurisdictional time permitted for such an appeal and/or further appellate process such as a motion for reconsideration or an application for writ of certiorari has passed without the filing of notice of such an appeal or the filing for further appellate process.

- (c) Company's Written Statement. Not later than thirty (30) Days after the issuance of a PUC order approving this Agreement, Company shall provide Seller with a copy of such order together with a written statement as to whether the conditions set forth in Section 29.20(a) (PUC Approval Order) have been met and the order constitutes a PUC Approval Order. If Company's written statement declares that the conditions set forth in Section 29.20(a) (PUC Approval Order) have been satisfied, the date of the issuance of the PUC Approval Order shall be the "PUC Approval Order Date".
- (d) Non-appealable PUC Approval Order Date. If Company provides the written statement referred to in Section 29.20 (c) (Company's Written Statement) to the effect that the conditions referred to in Section 29.20(a) (PUC Approval Order) have been satisfied, the term "Non-appealable PUC Approval Order Date" shall be defined as follows:
- (1) If a PUC Approval Order is issued and is not made subject to a motion for reconsideration filed with the PUC or an appeal, the Non-appealable PUC Approval Order Date shall be the date one Day after the expiration of Appeal Period following the issuance of the PUC Approval Order;
 - (2) If the PUC Approval Order became subject to a motion for reconsideration, and the motion for reconsideration is denied or the PUC Approval Order is affirmed after reconsideration, and such

order is not made subject to an appeal, the Non-appealable PUC Approval Order Date shall be deemed to be the date one Day after the expiration of the Appeal Period following the order denying reconsideration of or affirming the PUC Approval Order; or

- (3) If the PUC Approval Order, or an order denying reconsideration of the PUC Approval Order or affirming approval of the PUC Approval Order after reconsideration, becomes subject to an appeal, then the Non-appealable PUC Approval Order Date shall be the date upon which the PUC Approval Order becomes a non-appealable order within the meaning of the definition of a Non-Appealable PUC Approval Order in Section 29.20(b) (Non-appealable PUC Approval Order).

- (e) Unfavorable PUC Order. The term "Unfavorable PUC Order" means an order from the PUC concerning this Agreement that: (i) dismisses Company's application; (ii) denies Company's application; or (iii) approves Company's application but contains terms and conditions deemed unacceptable by Company in its sole discretion and therefore does not meet the definition of a PUC Approval Order as set forth in Section 29.20(a) (PUC Approval Order).

29.21 Community Outreach Plan. Seller has initiated, or has plans to initiate, discussions and/or informational sessions with community and neighborhood groups in and around the vicinity of the Facility to inform the neighboring public and community about the Facility and to gather information regarding neighboring public and community concerns regarding the Facility. Seller shall formulate and implement a community outreach plan no later than the PUC Submittal Date and provide a copy of such plan to Company upon its finalization and before implementation. The purpose and scope of such plan shall be in Seller's discretion, provided, however, that any such plan shall, at a minimum, include provisions to inform the neighboring community, allay concerns, and implement, where commercially reasonable and possible, requests from the community to garner support for the Facility from the neighboring community.

29.22 Change in Standard System or Organization.

- (a) Consistent With Original Intent. If, during the Term, any standard, system or organization referenced in this Agreement should be modified or replaced in the normal course of events, such modification or replacement shall from that point in time be used in this Agreement in place of the original standard, system or organization, but only to the extent such modification or replacement is generally consistent with the original spirit and intent of this Agreement.
- (b) Eliminated or Inconsistent With Original Intent. If, during the Term, any standard system or organization referenced in this Agreement should be eliminated or cease to exist, or is modified or replaced and such modification or replacement is inconsistent with the original spirit and intent of this Agreement, then in such event the Parties will negotiate in good faith to amend this Agreement to a standard, system or organization that would be consistent with the original spirit and intent of this Agreement.

29.23 No Third Party Beneficiaries. Nothing expressed or referred to in this Agreement will be construed to give any person or entity other than the Parties any legal or equitable right, remedy, or claim under or with respect to this Agreement or any provision of this Agreement. This Agreement and all of its provisions and conditions are for the sole and exclusive benefit of the Parties and their successors and permitted assigns.

29.24 Hawai'i General Excise Tax. Seller shall, when making payments to Company under this Agreement, pay such additional amount as may be necessary to reimburse Company for the Hawai'i general excise tax on gross income and all other similar taxes imposed on Company by any Governmental Authority with respect to payments in the nature of gross receipts tax, sales tax, privilege tax or the like (including receipt of any payment made under this Section 29.24 (Hawai'i General Excise Tax)), but excluding federal or state net income taxes. By way of example and not limitation, as of the Execution Date, all payments subject to the 4.5% Hawai'i general excise tax on O'ahu would include an additional 4.712% so that the underlying payment will be net of such tax liability.

29.25 Survival of Obligations. The rights and obligations that are intended to survive a termination of this Agreement are all of those rights and obligations that this Agreement

expressly provides shall survive any such termination and those that arise from Seller's or Company's covenants, agreements, representations, and warranties applicable to, or to be performed, at or during any time prior to or as a result of the termination of this Agreement, including, without limitation:

- (a) The obligation to pay Daily Delay Damages under Section 13.4 (Damages and Termination);
- (b) The obligation to pay Termination Damages under Article 16 (Damages in the Event of Termination by Company);
- (c) The indemnity obligations under Article 17 (Indemnification) and Section 29.17 (Proprietary Rights);
- (d) The dispute resolution provisions of Article 28 (Dispute Resolution);
- (e) Section 29.3 (Notices), Section 29.5 (Non-Waiver), Section 29.8 (Governing Law, Jurisdiction and Venue), Section 29.9 (Limitations), Section 29.13 (Severability), Section 29.14 (Settlement of Disputes), Section 29.15 (Environmental Credits and RPS), Section 29.17 (Proprietary Rights), Section 29.19 (Computation of Time), Section 29.23 (No Third Party Beneficiaries), Section 29.24 (Hawai'i General Excise Tax), Section 29.25 (Survival of Obligations), Section 7 (Land Restoration) of Attachment G (Company-Owned Interconnection Facilities) and Section 1(d) (Right of First Refusal) and Section 2(d) (Right of First Refusal) of Attachment P (Sale of Facility by Seller); and
- (f) Seller's obligations under Section 3 (Seller Payment to Company for Company-Owned Interconnection Facilities and Review of Facility) of Attachment G (Company-Owned Interconnection Facilities) to pay interconnection costs and Section 4 (Ongoing Operation and Maintenance Charges) of Attachment G (Company-Owned Interconnection Facilities) to pay operation and maintenance costs incurred up to the date of termination of the Agreement.

29.26 Certain Rules of Construction. For purposes of this Agreement:

- (a) "Including" and any other words or phrases of inclusion will not be construed as terms of limitation, so that references to "included" matters will be regarded as non-exclusive, non-characterizing illustrations.
- (b) "Copy" or "copies" means that the copy or copies of the material to which it relates are true, correct and complete.
- (c) When "Article," "Section," "Schedule," or "Attachment" is capitalized in this Agreement, it refers to an article, section, schedule or attachment to this Agreement.
- (d) "Will" has the same meaning as "shall" and, thus, connotes an obligation and an imperative and not a futurity.
- (e) Titles and captions of or in this Agreement, the cover sheet and table of contents of this Agreement, and language in parenthesis following Section references are inserted only as a matter of convenience and in no way define, limit, extend or describe the scope of this Agreement or the intent of any of its provisions.
- (f) Whenever the context requires, the singular includes the plural and plural includes the singular, and the gender of any pronoun includes the other genders.
- (g) Any reference to any statutory provision includes each successor provision and all applicable Laws as to that provision.

**[Signatures for PPA for Renewable Dispatchable Generation
appear on the following page]**

IN WITNESS WHEREOF, Company and Seller have executed this Agreement as of the day and year first above written.

By _____
Name:
Its:

By _____
Name:
Its:

("Company")

By _____
Name:
Its:

By _____
Name:
Its:

("Seller")

SCHEDULE OF DEFINED TERMS

For the purposes of this Agreement, the following capitalized terms shall have the meanings set forth below:

"Acceptance Test": A test conducted by Seller and witnessed by Company, within thirty (30) Days of completion of all Interconnection Facilities and in accordance with criteria and test procedures determined by Company and Seller as set forth in Section 2(f) (Acceptance Test Procedure) of Attachment G (Company-Owned Interconnection Facilities), to determine conformance with Article 3 (Facility Owned and/or Operated by Seller) and Attachment G (Company-Owned Interconnection Facilities) and Good Engineering and Operating Practices. Attachment N (Acceptance Test General Criteria) provides general criteria to be included in the written protocol for the Acceptance Test. Successful completion of the Acceptance Test shall be a condition precedent for the performance of the Control System Acceptance Test and the Commercial Operations Date.

"Active Power Control Interface": Shall have the meaning set forth in Section 1(g) (Active Power Control Interface) of Attachment B (Facility Owned by Seller) of this Agreement.

"Actual Output": The total quantity of electric energy (measured in kilowatt hours) produced by the Facility over a given time period and delivered to the Point of Interconnection, as measured by the revenue meter. "Actual Output" is the equivalent of "Net Energy."

"Actual WTGS Production": Shall have the meaning set forth in Section 2 (Defined Terms) of Attachment T (Calculation and Reporting of Production-Based Availability and Dispute Resolution by Independent PBA Evaluator).

"Agreement": Shall have the meaning set forth in the preamble to this Agreement.

"Allowed Capacity": Shall have the meaning set forth in Section 5(e) of Attachment A (Description of Generation and Conversion Facility) to this Agreement.

"Appeal Period": Shall have the meaning set forth in Section 29.20(b) (Non-appealable PUC Approval Order) of this Agreement.

"Applicable Period Lump Sum Payment": For each applicable period, the total amount of Lump Sum Payment payable during such period,

as such amount may be calculated and adjusted from time to time as set forth in Section 3 (Calculation of Lump Sum Payment) of Attachment J (Company Payments for Energy and Dispatchability) to this Agreement, including but not limited to any downward adjustment made pursuant to Section 3.iv of said Attachment J, but excluding any off-set of liquidated damages under Section 2.5(c) (Payment of Liquidated Damages for Failure to Achieve the PBAF Benchmark) and Section 2.6(d) (Payment of Liquidated Damages for Failure to Achieve BOP Benchmark) of this Agreement. For purposes of calculating liquidated damages under Section 2.5(b) (PBAF Benchmark and Liquidated Damages), the "Applicable Period Lump Sum Payment" is the monthly Lump Sum Payment payable for the last calendar month of the PBAF LD Period in question. For purposes of calculating liquidated damages under Section 2.6(c) (BOP Benchmark and Liquidated Damages), the "Applicable Period Lump Sum Payment" is the Lump Sum Payment payable for the Contract Year in question.

"Applicable NEP Verification Date": For the Initial OEPR, the Initial NEP Verification Date. For any Subsequent OEPR, the first day of the calendar month following the calendar month during which there occurs the second anniversary of the event (e.g., completion of equipment replacement) which occasioned the preparation of such Subsequent OEPR.

"Applicable Power Curve": Shall have the meaning set forth in Section 2 (Defined Terms) of Attachment T (Calculation and Reporting of Production-Based Availability and Dispute Resolution by Independent PBA Evaluator).

"Average Density-Adjusted Wind Speed": Shall have the meaning set forth in Section 2 (Defined Terms) of Attachment T (Calculation and Reporting of Production-Based Availability and Dispute Resolution by Independent PBA Evaluator).

"Bill of Material": A list of equipment to be installed at the Facility including, but not necessarily limited to, items such as relays, breakers, and switches.

"BOP": The "balance of the plant", i.e., the infrastructural components of the Facility (excluding the WTGS(s)) which support transfer of energy between the WTGS(s) and the Point of Interconnection. The infrastructure normally consists of the site electrical facilities, SCADA and the civil plant (such as foundations and roads), which support the operation and maintenance of the WTGS(s).

"BOP Benchmark": For each Contract Year, the BOP Benchmark for such Contract as determined under the applicable provisions of Section 2.6(b) (Determination of BOP Benchmark) of this Agreement and Section 7 (Disagreements Concerning Historical Power Curve, Production-Based Availability and BOP Benchmark) of Attachment T (Calculation and Reporting of Production-Based Availability and Dispute Resolution by Independent PBA Evaluator) to this Agreement.

"BOP Benchmark Determination Notice": Shall have the meaning specified in, as applicable, Section 2.6(b)(i) (First Two Contract Years), Section 2.6(b)(ii) (Commencing With Third Contract Year) or Section 2.6(b)(iii) (Commencing With First Subsequent OEPR and Thereafter) of this Agreement.

"BOP Benchmark Disagreement": Shall have the meaning set forth in Section 7(c) (Notice of Disagreement With BOP Benchmark Determination) of Attachment T (Calculation and Reporting of Production-Based Availability and Dispute Resolution by Independent PBA Evaluator) to this Agreement.

"BOP Benchmark Minus 3" and "BOP Benchmark Minus 6": Shall have the respective meanings set forth for in Section 2.6(c) (BOP Benchmark and Liquidated Damages) of this Agreement. For example, if the BOP Benchmark is 97%, the "BOP Benchmark Minus 3" is 94% and the "BOP Benchmark Minus 6" is 91%.

"BOP Efficiency Ratio": For each Contract Year, the estimated efficiency of the Facility during such Contract Year in delivering to the Point of Interconnection the electric energy produced by the WTGS(s). The BOP Efficiency Ratio constitutes the percentage calculated as provided in Section 2.6(a) (Calculation of Annual BOP Efficiency Ratio) of this Agreement.

"BOP LD Assessment Date": For each Contract Year, [**January 31st**] of the following Contract Year.

"BOP LD Assessment Notice": For each Contract Year for which liquidated damages are payable under Section 2.6(c) (BOP Benchmark and Liquidated Damages), the Company's written notice to Seller setting forth the amount of the liquidated damages together with the calculation of such liquidated damages.

"Business Day": Any calendar day that is not a Saturday, a Sunday, or a federal or Hawai'i state holiday.

"Claim": Any claim, suit, action, demand or proceeding.

"Claiming Entity": Shall mean Seller and any direct or indirect owner of a membership interest in Seller which is eligible to claim a Refundable Tax Credit or Non-Refundable Tax Credit in a given year.

"COD Delay LD Period": Shall have the meaning set forth in Section 13.4(a)(2).

"Commercial Operations": Upon satisfaction of the following conditions, the Facility shall be considered to have achieved Commercial Operations on the Day specified in Seller's written notice described below: (i) the Acceptance Test has been passed, (ii) all generating units have passed Control System Acceptance Tests, (iii) the Transfer Date has occurred, (iv) Seller has (1) provided to Company the Required Models (as defined in Section 6(a) (Seller's Obligation to Provide Models) of Attachment B (Facility Owned by Seller)) in the form of Source Code, (2) placed the current version of the Source Code for the Required Models with the Source Code Escrow Agent as required in Section 6(b)(i)(A) (Establishment of Source Code Escrow) of Attachment B (Facility Owned by Seller), or (3) if Seller is unable to arrange for the placement of the appropriate Source Code into the Source Code Escrow account, placed the required funds with the Monetary Escrow Agent as required in Section 6(b)(ii)(A) (Establishment of Monetary Escrow) of Attachment B (Facility Owned by Seller), and (v) Seller provides Company with written notice that (aa) Seller is ready to declare the Commercial Operations Date and (bb) the Commercial Operations Date will occur within 24 hours (i.e., the next Day).

"Commercial Operations Date" (or "COD"): The date on which Facility first achieves Commercial Operations.

"Company": Shall have the meaning set forth in the preamble to this Agreement.

"Company-Attributable Forced Outage": Shall have the meaning set forth in Section 2 (Defined Terms) of Attachment T (Calculation and Reporting of Production-Based Availability and Dispute Resolution by Independent PBA Evaluator).

"Company-Attributable Non-Performance": Shall have the meaning set forth in Section 2 (Defined Terms) of Attachment T (Calculation and Reporting of Production-Based Availability and Dispute Resolution by Independent PBA Evaluator).

"Company-Designated NEP Estimate": The estimated Net Energy Potential of the Facility as designated by Company pursuant to Section 1(c) (NEP IE Estimate and Company-Designated NEP Estimate) of Attachment U (Calculation and Adjustment of Net energy Potential) this Agreement.

"Company Dispatch": Company's right, through supervisory equipment or otherwise, to direct or control both the capacity and the energy output of the Facility from its minimum output rating to its maximum output rating consistent with this Agreement (including, without limitation, Good Engineering and Operating Practices and the requirements set forth in Attachment B (Facility Owned by Seller), Section 3 (Performance Standards) of this Agreement, which dispatch shall include real power, reactive power, voltage, frequency, the determination to cycle a unit off-line or to restart a unit, the droop control setting, the ramp rate setting, and other characteristics of such electric energy output whose parameters are normally controlled or accounted for in a utility dispatching system.

"Company-Owned Interconnection Facilities": Shall have the meaning set forth in Section 1(a) (Description of Company-Owned Interconnection Facilities) of Attachment G (Company-Owned Interconnection Facilities).

"Company System": The electric system owned and operated by Company (to include any non-utility owned facilities) consisting of power plants, transmission and distribution lines, and related equipment for the production and delivery of electric power to the public.

"Company System Operator": The authorized representative of Company who is responsible for carrying out Company dispatch and curtailment of electric energy generation interconnected to the Company System.

"Competitive Bidding Framework": The Framework for Competitive Bidding contained in Decision and Order No. 23121 issued by the Public Utilities Commission on December 8, 2006, and any subsequent orders providing for modifications from those set forth in Order No. 23121 issued December 8, 2006.

"Construction Delay LD Period": Shall have the meaning set forth in Section 13.4(a)(1).

"Construction Financing Closing Milestone": Shall have the meaning set forth in Attachment K (Guaranteed Project Milestones) and Attachment L (Reporting Milestones).

"Construction Milestones": The Reporting Milestones set forth in Attachment L (Reporting Milestones) and the Guaranteed Project Milestones set forth in Attachment K (Guaranteed Project Milestones).

"Construction Start Date Milestone": The date by which continuous construction of permanent structures shall begin at the Site in accordance with Attachment L (Reporting Milestones). **[FOR WIND FACILITIES ADD: The Construction Start Date occurs when Seller begins pouring the foundation for the first Wind Turbine. FOR PV FACILITIES ADD: The Construction Start Date occurs when Seller begins installation of the mounting and racking components.]**

"Consumer Advocate": Shall have the meaning set forth in Section 24.2 (Confidentiality).

"Contract Capacity": Shall have the meaning set forth in Section 5(b) (Design and Capacity) of (Attachment A (Description of Generation and Conversion Facility) to this Agreement.

"Contract Pricing": The total of the Energy Payment and the Lump Sum Payment.

"Contract Year": A twelve (12) calendar month period commencing on either: (i) the Commercial Operations Date (if the Commercial Operations Date occurs on the first Day of a calendar month) and thereafter on each anniversary of the Commercial Operations Date; or (ii) the first Day of the calendar month following the month during which the Commercial Operations Date occurs, and thereafter on each anniversary of the first Day of such month; provided, however, that, in the latter case, the initial Contract Year shall also include the Days from the Commercial Operations Date to the first Day of the succeeding calendar month.

"Control System Acceptance Test(s)": A test or tests performed on the centralized and collective control systems and Active Power Control Interface of the Facility, which includes successful completion of the Control System RTU Points List, in accordance with procedures set forth in Section 1(h) (Control System Acceptance Test Procedures) of Attachment B (Facility Owned by Seller). Attachment O (Control System Acceptance Test Criteria) provides general criteria to be included in the written protocol for the Control System Acceptance Test.

"Control System RTU Points List" - The Control System RTU Points List includes, but is not limited to, all of the Facility's equipment and generation performance/quality parameters that will be monitored, alarmed and/or controlled by Company's Energy Management System (EMS) throughout the Term of this Agreement.

Examples of the Control System RTU Points List include:

- Seller's substation/equipment status - breaker open/closed status, equipment normal/alarm operating status, etc.
- Seller's generation data (analog values) - number of generators available/online, voltage, current, MW, MVAR, etc.
- Seller's generation performance (status and/or analog values) - ramp rate, generator frequency, etc.
- Curtailment control interface - curtailment MW setpoint, etc.
- Voltage control interface - voltage kV setpoint, etc.
- Power factor control interface - power factor setpoint, etc.

This Control System RTU Points List is necessary for the effective operation of the Company System and will be tested during the Control System Acceptance Test.

"Daily Delay Damages": Shall have the meaning set forth in Section 13.4(a) (Daily Delay Damages) of this Agreement.

"Day": A calendar day.

"Defaulting Party": The Party whose failure, action or breach of its obligations under this Agreement results in an Event of Default under Article 15 (Events of Default) of this Agreement.

"Density-Adjusted Wind Speed": Shall have the meaning set forth in Section 2 (Defined Terms) of Attachment T (Calculation and Reporting of Production-Based Availability and Dispute Resolution by Independent PBA Evaluator).

"Development Period Security": An amount equal to \$50/kW of the Contract Capacity.

"Dispute": Shall have the meaning set forth in Section 28.1 (Good Faith Negotiations).

"DPR": Shall have the meaning set forth in Section 28.2 (Dispute Resolution Procedures, Mediation).

"Effective Date": Shall mean the last to occur of (i) the Non-appealable PUC Approval Order Date and (ii) the date that the Interconnection Requirements Amendment (if required pursuant to Section 12.4(a) of this Agreement) is executed and delivered as such date is set forth in the Interconnection Requirements Amendment.

"Eligible Period": Shall have the meaning set forth in Section 1(b)(ii)(H)(i) of Attachment B (Facility Owned by Seller) to this Agreement.

"EMS" or "Energy Management System": The real-time, computer-based control system, or any successor thereto, used by Company to manage the supply and delivery of electric energy to its consumers. It provides the Company System Operator with an integrated set of manual and automatic functions necessary for the operation of the Company System under both normal and emergency conditions. The EMS provides the interfaces for the Company System Operator to perform real-time monitoring and control of the Company System, including but not limited to monitoring and control of the Facility for system balancing, supplemental frequency control and economic dispatch as prescribed in this Agreement.

"Energy Cost Adjustment Clause": The provision in Company's rate schedules that allows Company to pass through to its customers Company's costs of fuel and purchased power.

"Energy Payment": The amount that Company will pay Seller for electric energy delivered to Company in accordance with the terms and conditions of this Agreement on a monthly basis as set forth in Attachment J (Company Payments for Energy and Dispatchability) to this Agreement.

"Engineering and Design Work": Shall have the meaning set forth in Section 3(a) of Attachment G (Company-Owned Interconnection Facilities).

"Environmental Credits": Any environmental credit, offset, or other benefit allocated, assigned or otherwise awarded by any Governmental Authority, international agency, or non-governmental renewable energy certificate accounting and verification organization to Company or Seller based in whole or in part on the

fact that the Facility is a non-fossil fuel facility. Such Environmental Credits shall include, without limitation, the non-energy attributes of renewable energy including, but not limited to, any avoided emissions of pollutants to the air, soil, or water such as sulfur dioxide, nitrogen oxides, carbon monoxide, particulate matter, and hazardous air pollutants; any other pollutant that is now or may in the future be regulated under the pollution control laws of the United States; and avoided emissions of carbon dioxide and any other greenhouse gas, along with the renewable energy certificate reporting rights to these avoided emissions, but in all cases shall not mean tax credits.

"Escrow Agent": Shall have the meaning set forth in Section 14.9 (L/C Proceeds Escrow).

"Evaluation Period": Shall have the meaning set forth in Section 1(b)(ii)(H)(i) of Attachment B (Facility Owned by Seller) to this Agreement.

"Evaluation Range": Shall have the meaning set forth in Section 1(b)(iii)(H)(i) of Attachment B (Facility Owned by Seller) to this Agreement.

"Event of Default": Shall have the meaning set forth in Article 15 (Events of Default) of this Agreement.

"Excess Energy Conditions": Shall have the meaning set forth in Section 2 (Defined Terms) of Attachment T (Calculation and Reporting of Production-Based Availability and Dispute Resolution by Independent PBA Evaluator).

"Execution Date": The date designated as such on the first page of this Agreement or, if no date is so designated, the date the Parties exchanged executed signature pages to this Agreement.

"Extended Term": Shall have the meaning set forth in Section 12.1 (Term) of this Agreement.

"Facility": Seller's renewable electric energy facility that is the subject of this Agreement, including all Seller-Owned Interconnection Facilities and all other equipment, devices, associated appurtenances owned, controlled, operated and managed by Seller in connection with, or to facilitate, the production, generation, transmission, delivery or furnishing of electric energy by Seller to Company and required to interconnect with the Company System.

"Facility Actual Production": Shall have the meaning set forth in Section 2 (Defined Terms) of Attachment T (Calculation and Reporting of Production-Based Availability and Dispute Resolution by Independent PBA Evaluator).

"Facility Debt": The obligations of Seller to any lender pursuant to the Financing Documents, including without limitation, principal of, premium and interest on indebtedness, fees, expenses or penalties, amounts due upon acceleration, prepayment or restructuring, swap or interest rate hedging breakage costs and any claims or interest due with respect to any of the foregoing.

"Facility Full Dispatch Production": Shall have the meaning set forth in Section 2 (Defined Terms) of Attachment T (Calculation and Reporting of Production-Based Availability and Dispute Resolution by Independent PBA Evaluator).

"Facility Lender": Any lender(s) providing any Facility Debt and any successor(s) or assigns thereto, collectively.

"Facility Lost Production": Shall have the meaning set forth in Section 2 (Defined Terms) of Attachment T (Calculation and Reporting of Production-Based Availability and Dispute Resolution by Independent PBA Evaluator).

"Facility PBAF": For each PBAF LD Period, the production-based availability factor for the Facility calculated as provided in Section 2.5(a) (Calculation of Facility PBAF) of this Agreement.

"FASB": Shall have the meaning set forth in Section 24.1 (Financial Compliance).

"FASB ASC 810": Shall have the meaning set forth in Section 24.1 (Financial Compliance).

"FASB ASC 842": Shall have the meaning set forth in Section 24.5 (Consolidation and Lease).

"Financial Compliance Information": Shall have the meaning set forth in Section 24.1 (Financial Compliance).

"Financial Termination Costs": Shall have the meaning set forth in Section 6 (Make Whole Amount) of Attachment P (Sale of Facility by Seller).

"Financing Documents": The loan and credit agreements, notes, bonds, indentures, security agreements, lease financing agreements, mortgages, deeds of trust, interest rate exchanges,

swap agreements and other documents relating to the development, bridge, construction and/or permanent debt financing for the Facility, including any credit enhancement, credit support, working capital financing, tax equity financing or refinancing documents, and any and all amendments, modifications, or supplements to the foregoing that may be entered into from time to time at the discretion of Seller in connection with development, construction, ownership, leasing, operation or maintenance of the Facility.

"First Benchmark Period": The period commencing on the Commercial Operations Date and ending on the last Day of the calendar month during which an OEPR Evaluator issues the Initial OEPR. During the First Benchmark Period, the First NEP Benchmark shall be the estimate of Net Energy Potential that is used to calculate the Lump Sum Payment as provided in Section 3.i of (Lump Sum Payment During First Benchmark Period) of Attachment J (Company Payments for Energy and Dispatchability) to this Agreement.

"First NEP Benchmark": The estimate of Net Energy Potential that is used to calculate the Lump Sum Payment during the First Benchmark Period as provided in Section 3.i (Lump Sum Payment During First Benchmark Period) of Attachment J (Company Payments for Energy and Dispatchability) to this Agreement. The "First NEP Benchmark" shall consist of whichever of the following is applicable as of the Commercial Operation Date, as more fully provided in Section 1(c) (NEP IE Estimate and Company-Designated NEP Estimate) and Section 1(d) (NEP IE Estimate, Liquidated Damages and Seller's Null and Void Right) of Attachment U (Calculation and Adjustment of Net Energy Potential) to this Agreement: (i) NEP RFP Projection, (ii) NEP IE Estimate, (iii) Company-Designated NEP Estimate or (iv) such other amount as the Parties may agree in writing.

"Force Majeure": Shall have the meaning set forth in Section 2 (Defined Terms) of Attachment T (Calculation and Reporting of Production-Based Availability and Dispute Resolution by Independent PBA Evaluator).

"Forced Outage": Shall have the meaning set forth in Section 2 (Defined Terms) of Attachment T (Calculation and Reporting of Production-Based Availability and Dispute Resolution by Independent PBA Evaluator).

"Full Dispatch": Shall have the meaning set forth in Section 2 (Defined Terms) of Attachment T (Calculation and Reporting of

Production-Based Availability and Dispute Resolution by Independent PBA Evaluator).

"Generating": Shall have the meaning set forth in Section 2 (Defined Terms) of Attachment T (Calculation and Reporting of Production-Based Availability and Dispute Resolution by Independent PBA Evaluator).

"Good Engineering and Operating Practices": The practices, methods and acts engaged in or approved by a significant portion of the electric utility industry for similarly situated U.S. facilities, considering Company's isolated island setting, that at a particular time, in the exercise of reasonable judgment in light of the facts known or that reasonably should be known at the time a decision is made, would be expected to accomplish the desired result in a manner consistent with law, regulation, reliability for an island system, safety, environmental protection, economy and expedition. With respect to the Facility, Good Engineering and Operating Practices include, but are not limited to, taking reasonable steps to ensure that:

- (a) Adequate materials, resources and supplies, including fuel, are available to meet the Facility's needs under normal conditions and reasonably foreseeable abnormal conditions.
- (b) Sufficient operating personnel are available and are adequately experienced and trained to operate the Facility properly, efficiently and within manufacturer's guidelines and specifications and are capable of responding to emergency conditions.
- (c) Preventive, routine and non-routine maintenance and repairs are performed on a basis that ensures reliable long-term and safe operation, and are performed by knowledgeable, trained and experienced personnel utilizing proper equipment, tools, and procedures.
- (d) Appropriate monitoring and testing is done to ensure equipment is functioning as designed and to provide assurance that equipment will function properly under both normal and reasonably foreseeable abnormal conditions.
- (e) Equipment is operated in a manner safe to workers, the general public and the environment and in accordance with equipment manufacturer's specifications, including, without limitation, defined limitations

such as steam pressure, temperature, moisture content, chemical content, quality of make-up water, operating voltage, current, frequency, rotational speed, polarity, synchronization, control system limits, etc.

"Governmental Approvals": All permits, licenses, approvals, certificates, entitlements and other authorizations issued by Governmental Authorities, as well as any agreements with Governmental Authorities, required for the construction, ownership, operation and maintenance of the Facility and the Company-Owned Interconnection Facilities, and all amendments, modifications, supplements, general conditions and addenda thereto.

"Governmental Authority": Any federal, state, local or municipal governmental body; any governmental, quasi-governmental, regulatory or administrative agency, commission, body or other authority exercising or entitled to exercise any administrative, executive, judicial, legislative, policy, regulatory or taxing authority or power; or any court or governmental tribunal.

"Guaranteed Commercial Operations Date": The date specified as such in Attachment K (Guaranteed Project Milestones) of this Agreement, by which Seller guarantees that it will achieve the Commercial Operations Date.

"Guaranteed 180-Day Milestone Date": The date that is 180 Days following the Effective Date, as specified in Attachment K (Guaranteed Project Milestones).

"Guaranteed Procurement Payment Date": The earlier of (i) date that is 30 Days following the Effective Date or (ii) **[INSERT CALENDAR DATE BY WHICH EQUIPMENT MUST BE ORDERED TO MEET CONSTRUCTION SCHEDULE]**.

"Guaranteed Project Milestone": Each of (i) the Procurement Payment Milestone, (ii) the 180-Day Milestone, (iii) Commercial Operations and (iv) any other of the milestone events identified as a "Guaranteed Project Milestone" in Attachment K (Guaranteed Project Milestones) of this Agreement.

"Guaranteed Project Milestone Date": Each of (i) the Guaranteed Procurement Payment Date, (ii) the Guaranteed 180-Day Milestone Date, (iii) the Guaranteed Commercial Operations Date, and (iv) any other milestone dates identified as a "Guaranteed Project Milestone Date" in Attachment K (Guaranteed Project Milestones) of this Agreement.

"Hawai'i Investment Tax Credit": Shall mean a credit against Hawai'i source income for which Seller is eligible on the Commercial Operations Date or thereafter because of investment in renewable energy technologies incorporated into the Facility.

"Hawai'i Production Tax Credit": Shall mean a credit against Hawai'i source income for which Seller is eligible on the Commercial Operations Date or thereafter because of the energy produced by the Facility.

"HEI": Hawaiian Electric Industries, Inc.

"HERA": The Hawai'i Electricity Reliability Administrator.

"HERA Law": Act 166 (Haw. Leg. 2012), which was passed by the 27th Hawai'i Legislature in the form of S.B. No. 2787, S.D. 2, H.D.2, C.D.1 on May 2, 2012 and signed by the Governor on June 27, 2012. The effective date for the law is July 1, 2012. The HERA Law authorizes (i) the PUC to develop, adopt, and enforce reliability standards and interconnection requirements, (ii) the PUC to contract for the performance of related duties with a party that will serve as the HERA, and (iii) the collection of a Hawai'i electricity reliability surcharge to be collected by Hawai'i's electric utilities and used by the HERA. Reliability standards and interconnection requirements adopted by the PUC pursuant to the HERA Law will apply to any electric utility and any user, owner, or operator of the Hawai'i electric system. The PUC also is provided with the authority to monitor and compel the production of data, files, maps, reports, or any other information concerning any electric utility, any user, owner or operator of the Hawai'i electric system, or other person, business, or entity, considered by the commission to be necessary for exercising jurisdiction over interconnection to the Hawai'i electric system, or for administering the process for interconnection to the Hawai'i electric system.

"Historical Power Curve": Shall have the meaning set forth in Section 2 (Defined Terms) of Attachment T (Calculation and Reporting of Production-Based Availability and Dispute Resolution by Independent PBA Evaluator).

"HPC Disagreement": Shall have the meaning set forth in Section 7(a) (Notice of Disagreement With Determination of Historical Power Curve) of Attachment T (Calculation and Reporting of Production Based Availability and Dispute Resolution by Independent PBA Evaluator).

"IEC": Shall have the meaning set forth in Section 2 (Defined Terms) of Attachment T (Calculation and Reporting of Production-Based Availability and Dispute Resolution by Independent PBA Evaluator).

"IEC Information Model": Shall have the meaning set forth in Section 2 (Defined Terms) of Attachment T (Calculation and Reporting of Production-Based Availability and Dispute Resolution by Independent PBA Evaluator).

"IEC 61400-12-1": Shall have the meaning set forth in Section 2 (Defined Terms) of Attachment T (Calculation and Reporting of Production-Based Availability and Dispute Resolution by Independent PBA Evaluator).

"IEC/TS 61400-26-1": Shall have the meaning set forth in Section 2 (Defined Terms) of Attachment T (Calculation and Reporting of Production-Based Availability and Dispute Resolution by Independent PBA Evaluator).

"IEC/TS 61400-26-2": Shall have the meaning set forth in Section 2 (Defined Terms) of Attachment T (Calculation and Reporting of Production-Based Availability and Dispute Resolution by Independent PBA Evaluator).

"IE Energy Assessment Report": The bankable energy assessment report (including but not limited to an assessment of the Facility's Net Energy Potential) prepared for the Facility Lender by an independent engineer as part of the Facility Lender's due diligence leading up to the Facility Lender's legally binding commitment to provide a specific amount of financing for the Project as evidenced by the Facility Lender's execution of the Financing Documents.

"Indemnified Company Party": Shall have the meaning set forth in Section 17.1(a) (Indemnification Against Third Party Claims) of this Agreement.

"Indemnified Seller Party": Shall have the meaning set forth in Section 17.2(a) (Indemnification Against Third Party Claims) of this Agreement.

"Independent Evaluator": A person empowered, pursuant to Section 23.5 (Failure to Reach Agreement) and Section 23.10 (Dispute) of this Agreement, to resolve disputes due to failure of the Parties to agree on a Performance Standards Revision Document.

"Independent PBA Evaluator": A person empowered, pursuant to Section 7(g) (Appointment of Independent PBA Evaluator) of Attachment T (Calculation and Reporting of Production-Based Availability and Dispute Resolution by Independent PBA Evaluator) to resolve disagreements due to failure of the Parties to resolve a HPC Disagreement, a PBA Disagreement or a BOP Benchmark Disagreement.

"Information Available": Shall have the meaning set forth in Section 2 (Defined Terms) of Attachment T (Calculation and Reporting of Production-Based Availability and Dispute Resolution by Independent PBA Evaluator).

"Information Available WTGS": Shall have the meaning set forth in Section 2 (Defined Terms) of Attachment T (Calculation and Reporting of Production-Based Availability and Dispute Resolution by Independent PBA Evaluator).

"Information Unavailable": Shall have the meaning set forth in Section 2 (Defined Terms) of Attachment T (Calculation and Reporting of Production-Based Availability and Dispute Resolution by Independent PBA Evaluator)..

"Initial NEP OEPR Estimate": The NEP OEPR Estimate set forth in or derived from the Initial OEPR, as more fully set forth in Section 4(e) (Terms of Engagement) of Attachment U (Calculation and Adjustment of Net Energy Potential) to this Agreement.

"Initial NEP Verification Date": The first Day of the calendar month following the calendar month during which there occurs the second anniversary of the Commercial Operations Date.

"Initial OEPR": The OEPR to be prepared pursuant in Section 2 (Initial OEPR) of Attachment U (Calculation and Adjustment of Net Energy Potential) to this Agreement.

"Initial Term": Shall have the meaning set forth in Section 12.1 (Term).

"Interconnection Facilities": The equipment and devices required to permit the Facility to operate in parallel with, and deliver electric energy to, the Company System and provide reliable and safe operation of, and power quality on, the Company System (in accordance with applicable provisions of the PUC's General Order No. 7, Company tariffs, operational practices, interconnection requirements studies, and planning criteria), such as, but not

limited to, transmission and distribution lines, transformers, switches, and circuit breakers.

"Interconnection Requirements Amendment": Shall have the meaning set forth in Section 12.4(a) of this Agreement.

"Interconnection Requirements Study" or "IRS": A study, performed in accordance with the terms of the IRS Letter Agreement to determine, among other things, (a) the system requirements and equipment requirements to interconnect the Facility with the Company System, (b) the Performance Standards for the Facility, and (c) an estimate of interconnection costs and project schedule for interconnection of the Facility.

"Interconnection Requirements Study Letter Agreement" or "IRS Letter Agreement": The letter agreement and any written, signed amendments thereto, between Company and Seller that describes the scope, schedule, and payment arrangements for the Interconnection Requirements Study.

"Interface Block Diagram": The visual representation of the signals between Seller and Company, including but not limited to, RTU points, digital fault recorder settings, telecommunications and protection signals.

"IU Shutdown": Shall have the meaning set forth in Section 2 (Defined Terms) of Attachment T (Calculation and Reporting of Production-Based Availability and Dispute Resolution by Independent PBA Evaluator).

"kV": Kilovolt.

"kW": Kilowatt. Unless expressly provided otherwise, all kW values stated in this Agreement are alternating current values and not direct current values.

"Land Rights": All easements, rights of way, licenses, leases, surface use agreements and other interests or rights in real estate.

"Laws": All federal, state and local laws, rules, regulations, orders, ordinances, permit conditions and other governmental actions.

"L/C Proceeds": Shall have the meaning set forth in Section 14.8 (Failure to Renew or Extend Letter of Credit).

"Losses": Any and all direct, indirect or consequential damages, fines, penalties, deficiencies, losses, liabilities (including settlements and judgments), costs, expenses (including reasonable attorneys' fees and court costs) and disbursements.

"Lost Production": Shall have the meaning set forth in Section 2 (Defined Terms) of Attachment T (Calculation and Reporting of Production-Based Availability and Dispute Resolution by Independent PBA Evaluator).

"Lump Sum Payment": The payment to be made by Company to Seller in exchange for Seller making the Net Energy Potential of the Facility available for dispatch by Company. The amount of the monthly Lump Sum Payment is to be allocated pro rata to each WTGS and shall be as calculated and adjusted as provided in Section 3 (Calculation of Lump Sum Payment) of Attachment J (Company Payments for Energy and Dispatchability) to this Agreement.

"Make Whole Amount": Shall have the meaning set forth in Section 6 (Make Whole Amount) of Attachment P (Sale of Facility by Seller).

"Malware": means computer software, code or instructions that: (a) intentionally, and with malice intent by a third party, adversely affect the operation, security or integrity of a computing, telecommunications or other digital operating or processing system or environment, including without limitation, other programs, data, databases, computer libraries and computer and communications equipment, by altering, destroying, disrupting or inhibiting such operation, security or integrity; (b) without functional purpose, self-replicate without manual intervention; (c) purport to perform a useful function but which actually performs either a destructive or harmful function, or perform no useful function other than utilize substantial computer, telecommunications or memory resources with the intent of causing harm; or (d) without authorization collect and/or transmit to third parties any information or data; including such software, code or instructions commonly known as viruses, Trojans, logic bombs, worms, adware and spyware.

"Management Meeting": Shall have the meaning set forth in Section 28.1 (Good Faith Negotiations).

"Manufacturer's Power Curve": Shall have the meaning set forth in Section 2 (Defined Terms) of Attachment T (Calculation and Reporting of Production-Based Availability and Dispute Resolution by Independent PBA Evaluator).

"Measured Wind Speed": Shall have the meaning set forth in Section 2 (Defined Terms) of Attachment T (Calculation and Reporting of Production Based Availability and Dispute Resolution by Independent Evaluator of Production-Based Availability).

"MMS": Meteorological monitoring station.

"MMT": Meteorological monitoring tower.

"Modified Information Model": Shall have the meaning set forth in Section 2 (Defined Terms) of Attachment T (Calculation and Reporting of Production Based Availability and Dispute Resolution by Independent Evaluator of Production-Based Availability).

"Monetary Authorized Use": Shall have the meaning set forth in Section 6(b)(ii)(H) (Authorized Use) of Attachment B (Facility Owned by Seller) of this Agreement.

"Monetary Escrow Agent": Shall mean [] or such other escrow agent approved by Company.

"Monetary Escrow Agreement": Shall mean a three party escrow agreement between Seller, Company and the Monetary Escrow Agent naming Company as beneficiary thereunder, which agreement shall be acceptable in form and substance to Company.

"Monitoring and Communication Equipment": Shall have the meaning set forth in Section 6.2 (Monitoring and Communication Equipment) of this Agreement.

"Monthly Progress Report": Shall have the meaning set forth in Section 13.7 (Monthly Progress Report).

"Most Recent Prior NEP Benchmark": In the event a Subsequent OEPR is prepared for an OEPR Period of Record ending on or after the commencement of the sixth (6th) Contract Year, the "Most Recent Prior NEP Benchmark" shall be (i) for the first such Subsequent OEPR, the Second NEP Benchmark that was used to calculate the Lump Sum Payment for the last month of the Second Benchmark Period pursuant to Section 3.iii.a of Attachment J (Company Payments for Energy Dispatchability) to this Agreement and (ii) for all Subsequent OEPRs prepared after the aforementioned first Subsequent OEPR, the NEP OEPR Estimate obtained from the immediately preceding Subsequent OEPR.

"MW": Megawatt. Unless expressly provided otherwise, all MW values stated in this Agreement are alternating current values and not direct current values.

"NEP IE Estimate": The estimated Net Energy Potential of the Facility to which the IE Energy Assessment Report assigns a P-Value of 95 for a ten-year period.

"NEP OEPR Estimate": For each OEPR, the estimated Net Energy Potential of the Facility to which such OEPR assigns a P-Value of 95 for a ten-year period.

"NEP RFP Projection": The Net Energy Potential of the Facility to which the Seller in Seller's [Response to RFP] assigns a P-Value of 95 for a ten-year period.

"Net Energy": The total quantity of electric energy (measured in kilowatt hours) produced by the Facility over a given time period and delivered to the Point of Interconnection, as measured by the revenue meter. "Net Energy" the equivalent of "Actual Output."

"Net Energy Potential": The estimated single number with a P-Value of 95 for the annual Net Energy that could be produced by the Facility based on the estimated long-term monthly and annual total of such production over a ten-year period. The Net Energy Potential is subject to adjustment as provided in Attachment U (Calculation and Adjustment of Net Energy Potential) to this Agreement, but in no circumstances shall the Net Energy Potential exceed the NEP RFP Projection.

"Non-appealable PUC Approval Order": Shall have the meaning set forth in Section 29.20(b) (Non-appealable PUC Approval Order) of this Agreement.

"Non-appealable PUC Approval Order Date": Shall have the meaning set forth in Section 29.20(d) (Non-appealable PUC Approval Order Date) of this Agreement.

"Non-defaulting Party": Shall have the meaning set forth in Section 15.4 (Rights of Non-Defaulting Party; Forward Contract) of this Agreement.

"Non-Generating" Shall have the meaning set forth in Section 2 (Defined Terms) of Attachment T (Calculation and Reporting of Production-Based Availability and Dispute Resolution by Independent PBA Evaluator).

"Non-performing Party": The Party who is in breach of, or is otherwise failing to perform, its obligations under this Agreement.

"Non-Refundable Tax Credit": Shall mean any U.S. federal tax credit and State of Hawai'i tax credit (including both a Hawai'i Investment Tax Credit and a Hawai'i Production Tax Credit) for which the federal government or State of Hawai'i is not required to refund any tax credit which exceeds the tax payments due to the federal government or State of Hawai'i by the Claiming Entity or to provide a cash rebate in lieu of such credit to the Claiming Entity.

"Notice of BOP Disagreement": The written notice of a BOP Disagreement submitted by Seller within 30-Day period set forth in Section 7(c) (Notice of Disagreement With BOP Determination) of Attachment T (Calculation and Reporting of Production-Based Availability and Dispute Resolution by Independent PBA Evaluator).

"Notice of Disagreement": Any of a Notice of BOP Disagreement, a Notice of PBA Benchmark Disagreement and a Notice of HPC Disagreement.

"Notice of HPC Disagreement": The written notice of HPC Disagreement submitted by Seller within the 30-Day period set forth in Section 7(a) (Notice of Disagreement With Historical Power Curve Determination) of Attachment T (Monthly Reporting and Dispute Resolution by Independent PBAF Evaluator) to this Agreement.

"Notice of PBA Disagreement": The written notice of PBA Disagreement submitted by Company within the 10-Business Day period set forth in Section 7(b) (Notice of Disagreement With PBA Report) of Attachment T (Calculation and Reporting of Production-Based Availability and Dispute Resolution by Independent PBA Evaluator) to this Agreement.

"180-Day Milestone": All of the events identified as constituting the "180-Day Milestone" in Attachment K (Guaranteed Project Milestones).

"OEPR": An Operational Energy Production Report, including the Initial OEPR and each Subsequent OEPR.

"OEPR Consultants List": The engineering firms listed in Section 4(h) (Acceptable Persons and Entities) of Attachment U (Calculation and Adjustment of Net Energy Potential) to this

Agreement, as such list may be expanded or contracted by the Parties as provided in Section 4(b) (Eligibility for Appointment as OEPR Evaluator) of said Attachment U or Section 7(h) (Eligibility for Appointment as Independent PBA Evaluator) of Attachment T (Calculation and Reporting of Production-Based Availability and Dispute Resolution by Independent PBA Evaluator) to this Agreement.

"OEPR Evaluator": Shall have the meaning set forth in Section 4(a) (Selection of OEPR Evaluator) of Attachment U (Calculation and Adjustment of Net Energy Potential) of this Agreement.

"OEPR Period of Record": For each OEPR, the twelve-month period preceding the Applicable NEP Verification Date for such OEPR.

"Operating Period Security": Shall have the meaning set forth in Section 14.4 (Operating Period Security).

"Operative": Shall have the meaning set forth in Section 2 (Defined Terms) of Attachment T (Calculation and Reporting of Production-Based Availability and Dispute Resolution by Independent PBA Evaluator).

"Out of Electrical Specification": Shall have the meaning set forth in Section 2 (Defined Terms) of Attachment T (Calculation and Reporting of Production-Based Availability and Dispute Resolution by Independent PBA Evaluator).

"Out of Environmental Specification": Shall have the meaning set forth in Section 2 (Defined Terms) of Attachment T (Calculation and Reporting of Production-Based Availability and Dispute Resolution by Independent PBA Evaluator).

"Ownership Control": Shall have the meaning set forth in Section 1(b)(ii) of Attachment P (Sale of Facility by Seller) to this Agreement.

"Ownership Interest": Shall have the meaning set forth in Section 1(b)(i) of Attachment P (Sale of Facility by Seller) to this Agreement.

"P-Value": The probability of exceedance.

"Partial Dispatch": Shall have the meaning set forth in Section 2 (Defined Terms) of Attachment T (Calculation and Reporting of Production-Based Availability and Dispute Resolution by Independent PBA Evaluator).

"Parties": Seller and Company, collectively.

"Party": Each of Seller or Company.

"PBA Disagreement": Shall have the meaning set forth in Section 7(b) (Notice of Disagreement With PBA Report) of Attachment T (Calculation and Reporting of Production-Based Availability and Dispute Resolution by Independent PBA Evaluator) to this Agreement.

"PBA Report": The report of the data (both for the calendar month and the PBAF LD Period ending with such calendar month) necessary for the calculation of, among other things, the Facility PBAF, to be provided by Seller to Company as set forth in Section 6 (Monthly Report) of Attachment T (Monthly Reporting and Dispute Resolution by Independent PBA Evaluator) to this Agreement.

"PBAF Benchmark": For each PBAF LD Period, a Facility PBAF of not less than **95%**.

"PBAF Disagreement": Shall have the meaning set forth in Section 7(b) (Notice of Disagreement With PBA Report) of Attachment T (Calculation and Reporting of Production-Based Availability and Dispute Resolution by Independent PBA Evaluator) to this Agreement.

"PBAF LD Assessment Date": For the last month of each PBAF LD Period, the Day following the expiration of the 10-Business Day period provided for Company to submit a written notice of PBA Disagreement pursuant to Section 7(b) (Notice of Disagreement With PBA Report) of Attachment T (Calculation and Reporting of Production-Based Availability and Dispute Resolution by Independent PBA Evaluator) to this Agreement.

"PBAF LD Period": A rolling period of twelve (12) calendar months each. At the end of each calendar month, the PBAF LD Period rolls forward to include the next calendar month. The initial "PBAF LD Period" shall consist of the 12 full calendar months of the initial Contract Year.

"PBAF LDs": The liquidated damages payable by Seller as provided in Section 2.5(b) (PBAF Benchmark and Liquidated Damages).

"Performance Standards": The various performance standards for the operation of the Facility and the delivery of electric energy from the Facility to Company specified in Section 3 (Performance

Standards) of Attachment B (Facility Owned by Seller), as such standards may be revised from time to time pursuant to Article 23 (Process for Addressing Revisions to Performance Standards) of this Agreement.

"Performance Standards Information Request": A written notice from Company to Seller proposing revisions to one or more of the Performance Standards then in effect and requesting information from Seller concerning such proposed revision(s).

"Performance Standards Modifications": For each Performance Standards Revision, any capital improvements, additions, enhancements, replacements, repairs or other operational modifications to the Facility and/or to changes in Seller's operations or maintenance practices necessary to enable the Facility to achieve the performance requirements of such Performance Standards Revision.

"Performance Standards Pricing Impact": Any adjustment in Contract Pricing necessary to specifically reflect the recovery of the net costs and/or net lost revenues specifically attributable to any Performance Standards Modification necessary to comply with a Performance Standard Revision, which shall consist of the following: (i) recovery of, and return on, any capital investment (aa) made over a cost recovery period starting after the Performance Standards Revision is made effective following a PUC Performance Standards Revision Order through the end of the Initial Term and (bb) based on a proposed capital structure that is commercially reasonable for such an investment and the return on investment is at market rates for such an investment or similar investment); (ii) recovery of reasonably expected net additional operating and maintenance costs; and (iii) an adjustment in pricing necessary to compensate Seller for reasonably expected reductions, if any, in the delivery of electric energy to Company under this Agreement, which shall consist of (yy) an increase in payments necessary to compensate Seller for expected reduced electric energy payments under this Agreement; and (zz) to the extent applicable, an increase in payments necessary to compensate Seller for reasonably expected reductions in receipt of production tax credits (pursuant to Section 45 of the Internal Revenue Code) calculated on an after-tax basis.

"Performance Standards Proposal": A written communication from Seller to Company detailing the following with respect to a proposed Performance Standards Revision: (i) a statement as to whether Seller believes that it is technically feasible to comply with the Performance Standards Revision and the basis therefor;

(ii) the Performance Standards Modifications proposed by Seller to comply with the Performance Standards Revision; (iii) the capital and incremental operating costs of any necessary technical improvements, and any other incremental net operating or maintenance costs associated with any necessary operational changes, and any expected lost revenues associated with expected reductions in electric energy delivered to Company; (iv) the Performance Standards Pricing Impact of such costs and/or lost revenues; (v) information regarding the effectiveness of such technical improvements or operational modifications; (vi) proposed contractual consequences for failure to comply with the Performance Standard Revision that would be commercially reasonable under the circumstances; and (vii) such other information as may be reasonably required by Company to evaluate Seller's proposals. A Performance Standards Proposal may be issued either in response to a Performance Standards Information Request or on Seller's own initiative.

"Performance Standards Revision": A revision, as specified in a Performance Standards Information Request or a Seller-initiated Performance Standards Proposal, to the Performance Standards in effect as of the date of such Request or Proposal.

"Performance Standards Revision Document": A document specifying one or more Performance Standards Revisions and setting forth the changes to the Agreement necessary to implement such Performance Standards Revision(s). A Performance Standards Revision Document may be either a written agreement executed by Company and Seller or as directed by the Independent Evaluator pursuant to Section 23.10 (Dispute) of this Agreement, in the absence of such written agreement.

"Permit Application Filing Date Milestone": The date by which Seller shall file all applications for Government Approvals required for the ownership, construction, operation and maintenance of the Facility as set forth in Attachment K (Guaranteed Project Milestones).

"Planned Corrective Action": Shall have the meaning set forth in Section 2 (Defined Terms) of Attachment T (Calculation and Reporting of Production-Based Availability and Dispute Resolution by Independent PBA Evaluator).

"Point of Interconnection": The point of delivery of electric energy and/or capacity supplied by Seller to Company, where the Facility owned by the Seller interconnects with the Company System. The Seller shall own and maintain the facilities from the

Facility to the Point of Interconnection, excluding any Company-Owned Interconnection Facilities located on the Site. The Company shall own and maintain the facilities from the Point of Interconnection to the Company's system. The Point of Interconnection will be identified in the IRS and set forth on the Single-Line Drawing and Interface Block Diagram in Attachment E (Single Line Drawing and Interface Block Diagram).

"Potential Production": Shall have the meaning set forth in Section 2 (Defined Terms) of Attachment T (Calculation and Reporting of Production-Based Availability and Dispute Resolution by Independent PBA Evaluator).

"Power Curve": Shall have the meaning set forth in Section 2 (Defined Terms) of Attachment T (Calculation and Reporting of Production-Based Availability and Dispute Resolution by Independent PBA Evaluator).

"Power Curve Calculation Data Period": Shall have the meaning set forth in Section 2 (Defined Terms) of Attachment T (Calculation and Reporting of Production-Based Availability and Dispute Resolution by Independent PBA Evaluator).

"Power Curve Calculation Date": Shall have the meaning set forth in Section 2 (Defined Terms) of Attachment T (Calculation and Reporting of Production-Based Availability and Dispute Resolution by Independent PBA Evaluator).

"Power Possible": The calculated power production of the Facility reported every two seconds in kilowatts ("kW") at the Point of Interconnection taking into account (i) equipment availability during the period (for example, self-curtailed units, derated units and units that are otherwise unavailable to produce electric energy), (ii) electric energy consumed by the Facility and electric losses from the solar panels to the Point of Interconnection and (iii) meteorological conditions. For purposes of performing the evaluations under Section 1(b)(iii)(H) of Attachment B (Facility Owned by Seller), Power Possible is the 10-minute average of the Power Possible reported signaled as aforesaid.

"Power Possible Discrepancy Period": Any Evaluation Period that satisfies the conditions of a Power Possible Discrepancy Period under Section 1(b)(iii)(H)(ii) of Attachment B (Facility Owned by Seller) to this Agreement.

"PPA Amendment Deadline": The 60th Day following the date the completed IRS is provided to Seller, or such later date as Company and Seller may agree to by written agreement.

"Prime Rate": The "prime rate" of interest, as published from time to time by The Wall Street Journal in the "Money Rates" section of its Western Edition Newspaper (or the average prime rate if a high and a low prime rate are therein reported). The Prime Rate shall change without notice with each change in the prime rate reported by The Wall Street Journal, as of the date such change is reported. Any such rate is a general reference rate of interest, may not be related to any other rate, may not be the lowest or best rate actually charged by any lender to any customer or a favored rate and may not correspond with future increases or decreases in interest rates charged by lenders or market rates in general.

"Procurement Payment Milestone": The payment in full by Seller to Company of the amount required under Section 3(b)(iii) (Balance of Company-owned Interconnection Facilities Prepayment) of Attachment G (Company-Owned Interconnection Facilities).

"Project": The Facility as described in Attachment A (Description of Generation and Conversion Facility).

"Project Documents": This Agreement, any ground lease or other agreement or instrument in respect of the Site and/or the Land Rights, all construction contracts to which Seller is or becomes a party thereto, operation and maintenance agreements, and all other agreements, documents and instruments to which Seller is or becomes a party thereto in respect of the Facility, other than the Financing Documents, as the same may be modified or amended from time to time in accordance with the terms thereof.

"Proprietary Rights": Shall have the meaning set forth in Section 29.17 (Proprietary Rights) of this Agreement.

"PUC": Shall have the meaning set forth in the Recitals.

"PUC Approval Order": Shall have the meaning set forth in Section 29.20(a) (PUC Approval Order) of this Agreement.

"PUC Approval Order Date": Shall have the meaning set forth in Section 29.20(c) (Company's Written Statement) of this Agreement.

"PUC Approval Time Period": Shall have the meaning set forth in Section 12.6(b) (Time Period for PUC Approval).

"PUC Performance Standards Revision Order": The decision and order of the PUC approving the application or motion by the Parties seeking (i) approval of the Performance Standards Revision in question and the associated Performance Standards Revision Document, (ii) finding that the impact of the changes to the Contract Pricing on Company's revenue requirements is reasonable, and (iii) approval to include the costs arising out of pricing changes in Company's Energy Cost Adjustment Clause (or equivalent).

"PUC Submittal Date": The date of the submittal of Company's complete application or motion for a satisfactory PUC Approval Order pursuant to Section 12.3 (PUC Approval) of this Agreement.

"PUC's Standards": Standards for Small Power Production and Cogeneration in the State of Hawai'i, issued by the Public Utilities Commission of the State of Hawai'i, Chapter 74 of Title 6, Hawai'i Administrative Rules, currently in effect and as may be amended from time to time.

"Qualifying Facility": As defined in the Public Utility Regulatory Policies Act of 1978, as amended from time to time and as applied in Hawai'i by the PUC, and the regulations issued thereunder.

"Recipient": Shall have the meaning set forth in Section 24.2 (Confidentiality).

"Refundable Tax Credit": Shall mean any U.S. federal tax credit or State of Hawai'i tax credit (including both a Hawai'i Investment Tax Credit and a Hawai'i Production Tax Credit) for which the federal government or State of Hawai'i is required to refund any tax credit which exceeds the tax payments due to the federal government or State of Hawai'i by the Claiming Entity or to provide a cash rebate in lieu of such credit to the Claiming Entity.

"Renewable Portfolio Standards" or "RPS": The Hawai'i law that mandates that Company and its subsidiaries generate or purchase certain amounts of their net electricity sales over time from qualified renewable resources. The RPS requirements in Hawai'i are currently codified as Hawai'i Revised Statutes (HRS) 269-91 through 269-95.

"Renewable Resource Baseline": The estimated renewable resource potential of the Site for a typical meteorological year. For avoidance of doubt, the purpose of this term is to provide a

short-hand characterization of the nature of the renewable resource risk assumed by the Seller under this Agreement in making its Site selection.

"Renewable Resource Variability": The variations, above and below the Renewable Resource Baseline, of the renewable resource actually available at the Site on a moment-to-moment basis. For avoidance of doubt, the purpose of this term is to provide a short-hand characterization of the nature of the renewable resource risk assumed by the Company under this Agreement in agreeing to make fixed payments in an amount calculated on the basis of the Facility's capability to deliver the Net Energy Potential regardless of whether or not sufficient renewable resource is in fact available at any particular moment.

"Required Model" or "Required Models": Shall have the meaning set forth in Section 6(a) (Seller's Obligation to Provide Models) of Attachment B (Facility Owned by Seller) of this Agreement.

"Reporting Milestones": Each of the milestones identified as such in Attachment L (Reporting Milestones).

"Revenue Metering Package": The revenue meter, revenue metering PTs and CTs, and secondary wiring

"RPS Amendment": Any amendment to the RPS subsequent to Effective Date that revises the definition of "renewable electric energy" under the RPS such that the electric energy delivered from the Facility no longer comes within such revised definition.

"RPS Modifications": Any capital improvements, additions, enhancements, replacements, repairs or other operational modifications to the Facility and/or to changes in Seller's operations or maintenance practices necessary to enable the electric energy delivered from the Facility to come within the revised definition of "renewable electrical energy" resulting from a RPS Amendment.

"RPS Modifications Document": Shall have the meaning set forth in Section 3.4(c) (RPS Modifications Document).

"RPS Pricing Impact": Any adjustment in Contract Pricing necessary to specifically reflect the recovery of the net costs and/or net lost revenues specifically attributable to any RPS Modification, which shall consist of the following: (i) recovery of, and return on, any capital investment (aa) made over a cost recovery period starting after the RPS Modification is made effective following a

PUC RPS Order through the end of the Initial Term and (bb) based on a proposed capital structure that is commercially reasonable for such an investment and the return on investment is at market rates for such an investment or similar investment); (ii) recovery of reasonably expected net additional operating and maintenance costs; and (iii) an adjustment in pricing necessary to compensate Seller for reasonably expected reductions, if any, in the delivery of electric energy to Company under this Agreement, which shall consist of (aa) an increase in payments necessary to compensate Seller for expected reduced electric energy payments under this Agreement; and (bb) to the extent applicable, an increase in payments necessary to compensate Seller for reasonably expected reductions in receipt of production tax credits (pursuant to Section 45 of the Internal Revenue Code) calculated on an after-tax basis.

"RTU" or "Remote Terminal Unit" The interface between Company's EMS and the physical equipment at the Facility.

"SCADA" or "Supervisory Control And Data Acquisition" The Company system that provides remote control and monitoring of Company's transmission and sub-transmission systems and enables Company to perform real-time control of equipment in the field and to monitor the conditions and status of the Company System.

"Scheduled Maintenance": Shall have the meaning set forth in Section 2 (Defined Terms) of Attachment T (Calculation and Reporting of Production-Based Availability and Dispute Resolution by Independent PBA Evaluator).

"Second Benchmark Period": The period commencing on the first Day of the calendar month following the month during which an OEPR Evaluator issues the Initial OEPR and ending with the expiration of the fifth (5th) Contract Year. For avoidance of doubt, the effect of the foregoing definition is that the Second Benchmark Period will follow immediately upon the expiration of the First Benchmark Period.

"Second NEP Benchmark": For each calendar month during the Second Benchmark Period, the estimate of Net Energy Potential to be used during such calendar month to calculate the Lump Sum Payment pursuant to Section 3.ii.a of Attachment J (Company Payments for Energy and Dispatchability) to this Agreement. For avoidance of doubt, the Second NEP Benchmark may vary during the Second Benchmark Period as and to the extent provided in said Section 3.ii.a.

"Security Funds": Shall have the meaning set forth in Section 14.6 (Security Funds).

"Seller": Shall have the meaning set forth in the preamble to this Agreement.

"Seller-Attributable Non-Generation": Shall have the meaning set forth in Section 2 (Defined Terms) of Attachment T (Calculation and Reporting of Production-Based Availability and Dispute Resolution by Independent PBA Evaluator).

"Seller-Attributable Non-Performance": Shall have the meaning set forth in Section 2 (Defined Terms) of Attachment T (Calculation and Reporting of Production-Based Availability and Dispute Resolution by Independent PBA Evaluator).

"Seller-Attributable System Conditions": Shall have the meaning set forth in Section 2 (Defined Terms) of Attachment T (Calculation and Reporting of Production-Based Availability and Dispute Resolution by Independent PBA Evaluator).

"Seller-Owned Interconnection Facilities": The Interconnection Facilities constructed and owned by Seller.

"Seller's RPS Modifications Proposal": Shall have the meaning set forth in Section 3.4(a) (Renewable Portfolio Standards).

"Shutdown Not Requested by Company": Shall have the meaning set forth in Section 2 (Defined Terms) of Attachment T (Calculation and Reporting of Production-Based Availability and Dispute Resolution by Independent PBA Evaluator).

"Shutdown Requested by Company": Shall have the meaning set forth in Section 2 (Defined Terms) of Attachment T (Calculation and Reporting of Production-Based Availability and Dispute Resolution by Independent PBA Evaluator).

"Site": The parcel of real property on which the Facility will be constructed and located, together with any Land Rights reasonably necessary for the construction, ownership, operation and maintenance of the Facility. The Site is identified in Attachment A (Description of Generation and Conversion Facility) to this Agreement.

"Source Code": Shall mean the human readable source code of the Required Models which: (i) will be narrated documentation related to the compilation, linking, packaging and platform requirements

and any other materials or software sufficient to enable a reasonably skilled programmer to build, modify and use the code within a commercially reasonable period of time for the purposes of a Source Code Authorized Use; and (ii) can reasonably be compiled by a computer for execution.

"Source Code Authorized Use": Shall have the meaning set forth in Section 6(b)(i)(E) (Authorized Use) of Attachment B (Facility Owned by Seller) of this Agreement.

"Source Code Escrow": Shall mean the escrow established with the Source Code Escrow Agent under the terms of the Source Code Escrow Agreement under which Source Code shall be confidentially deposited by a Source Code Owner for safekeeping and, upon the satisfaction of certain conditions, release to the Company.

"Source Code Escrow Agent": Shall mean Iron Mountain Intellectual Property Management, Inc. or such other similar escrow agent approved by Company.

"Source Code Escrow Agreement": Shall mean a multi-party escrow agreement between Company, Source Code Escrow Agent and any and all Source Code Owners depositing Source Code into the Source Code Escrow which, among other matters, names Company as beneficiary thereunder, and is otherwise acceptable in form and substance to Company.

"Source Code Owner": Shall mean the developer and/or owner of the Required Models utilizing Source Code authorized to deposit the Source Code with the Source Code Escrow Agent upon the terms of the Source Code Escrow Agreement.

"SOX 404": Shall have the meaning set forth in Section 24.1 (Financial Compliance).

"Submission Notice": The notice issued pursuant to Section 7(g) (Appointment of Independent PBA Evaluator) of Attachment T (Calculation and Reporting of Production Based Availability and Dispute Resolution by Independent Evaluator of Production-Based Availability) to this Agreement.

"Subsequent NEP OEPR Estimate": For each Subsequent OEPR, the NEP OEPR Estimate derived from such Subsequent OEPR.

"Subsequent OEPR": Any OEPR prepared pursuant to Section 3 (Subsequent OEPRs) of Attachment U (Calculation and Adjustment of Net Energy Potential) to this Agreement.

"Suspended": Shall have the meaning set forth in Section 2 (Defined Terms) of Attachment T (Calculation and Reporting of Production-Based Availability and Dispute Resolution by Independent PBA Evaluator).

"Technical Standby": Shall have the meaning set forth in Section 2 (Defined Terms) of Attachment T (Calculation and Reporting of Production-Based Availability and Dispute Resolution by Independent PBA Evaluator).

"Term": Shall mean, collectively, the Initial Term and the Extended Term (if any).

"Termination Damages": Shall have the meaning set forth in Section 15.4 (Rights of the Non-Defaulting Party; Forward Contract) and shall be calculated in accordance with Article 16 (Damages in the Event of Termination by Company) of this Agreement.

"Termination Deadline": The 14th Day following the date the completed IRS is provided to Seller, or such later date as Company and Seller may agree to by a written agreement.

"Third Party": Any person or entity other than Company or Seller, and includes, but is not limited to, any subsidiary or affiliate of Seller.

"Total Actual Interconnection Cost": Actual costs for the Interconnection Facilities, to be designed, engineered and constructed by Company, as provided in Attachment G (Company-Owned Interconnection Facilities).

"Total Actual Relocation Cost": Shall have the meaning set forth in Section 5(b) of Attachment G (Company-Owned Interconnection Facilities).

"Total Estimated Interconnection Cost": Estimated costs for the Interconnection Facilities, to be designed, engineered and constructed by Company, as provided in Attachment G (Company-Owned Interconnection Facilities).

"Total Estimated Relocation Cost": Shall have the meaning set forth in Section 5(a) of Attachment G (Company-Owned Interconnection Facilities).

"Transfer Date": The date, prior to the Commercial Operations Date, upon which Seller transfers to Company all right, title and

interest in and to Company-Owned Interconnection Facilities to the extent, if any, that such facilities were constructed by Seller and/or its contractors.

"Unfavorable PUC Order": Shall have the meaning set forth in Section 29.20(e) (Unfavorable PUC Order).

"Unit Price": \$ ____ per ____ kWh of Net Energy Potential annually.
[TO BE CALCULATED FROM RESPONSE TO RFP.]

"WTGS": Each wind turbine generating system and its internal components and subsystems, as installed at the Facility.

ATTACHMENT A
DESCRIPTION OF GENERATION AND CONVERSION FACILITY

1. Name of Facility: _____
 - (a) Location: _____ (TMK No. _____)
 - (b) Telephone number (for system emergencies):
_____-_____
_____-_____
 - (c) E-mail Address: _____
 - (d) Contact Information for notices pursuant to Section 29.3 (Notices) of the Agreement:
Mailing Address: _____
Address for Delivery by Hand or Overnight
Delivery: _____
E-Mail Address: _____

2. Owner (If different from Seller):

If Seller is not the owner, Seller shall provide Company with a certified copy of a certificate warranting that the owner is a corporation, partnership or limited liability company in good standing with the Hawai'i Department of Commerce and Consumer Affairs which shall be attached hereto as Exhibit A-1 (Good Standing Certificates).

3. Operator: _____

4. Name of person to whom payments are to be made:

 - (a) Mailing address: _____

 - (b) Hawai'i Gross Excise Tax License number: _____

5. Equipment:
 - (a) Type of facility and conversion equipment:

[For example: Small power production facility designated as a Qualifying Facility that produces electric energy using _____.]

(b) Design and capacity

Total Facility Capacity ("Contract Capacity"):
_____ kW

Total Number of Generators:

[number and size of each generator. e.g. one (1) Brand X, 200 kW; one (1) Brand Y, 300 kW]

Description of Equipment:

[For example: Describe the type of energy conversion equipment, capacity, and any special features.]

Individual unit: **[if more than one generator, list information for each generator]**

	kW	kVAR Consumed	kVAR Produced
<u>Full load</u>			
<u>Startup</u>			

Generator:

Type _____

Rated Power _____ kW

Voltage _____ V, _____ phase

Frequency _____ HZ

Class of Protection _____

Number of Poles _____

Rated Speed _____ rpm

Rated Current _____ A

Rated Power Factor See Exhibit B-2

(c) Single or 3 phase: _____ phase

(d) Name of manufacturer:

- (e) The "Allowed Capacity" of this Agreement shall be the lower of (i) Contract Capacity or (ii) the net nameplate capacity (net for export) of the Facility installed by the Commercial Operations Date.
- (f) Seller may propose revisions to this Section 5 (Equipment) of Attachment A (Description of Generation and Conversion Facility) ("Section 5") for Company's approval prior to commencement of construction, provided, however, that (i) no such revision to this Section 5 shall change the type of Facility or conversion equipment deployed at the Facility from a wind energy conversion facility using wind turbines; (ii) Seller shall be in compliance with all other terms and conditions of this Agreement; and (iii) such revision(s) shall not change the characteristics of the Facility equipment or the specifications used in the IRS. Any revision to this Section 5 complying with items (i) through (iii) above shall be subject to Company's prior approval, which approval shall not be unreasonably withheld. If Seller's proposed revision(s) to this Section 5 otherwise satisfies items (i) and (ii) above but not item (iii) such that Company, in its reasonable discretion, determines that a re-study or revision to all or any part of the IRS is required to accommodate Seller's proposed revision(s), Company may, in its sole and absolute discretion, conditionally approve such revision(s) subject to a satisfactory re-study or revision to the IRS and Seller's payment and continued obligation to be liable and responsible for all costs and expenses of re-studying or revising such portions of the IRS and for modifying and paying for all costs and expenses of modification to the Facility, the Company-Owned Interconnection Facilities based on the results of the re-studies or revisions to the IRS. Any changes made to this Attachment A (Description of Generation and Conversion Facility) or the Agreement as a result of this Section 5(f) of Attachment A (Description of Generation and Conversion Facility) shall be reflected in a written amendment to the Agreement.

Seller understands and acknowledges that Company's review and approval of Seller's proposed revisions

to this Section 5 and any necessary re-studies or revisions to the IRS shall be subject to Company's then-existing time and personnel constraints. Company agrees to use commercially reasonable efforts, under such time and personnel constraints, to complete any necessary reviews, approvals and/or re-studies or revisions to the IRS.

Any delay in completing, or failure by Seller to meet, any subsequent Seller milestones under Article 13 (Guaranteed Project Milestone Including Commercial Operations) as a result of any revision pursuant to this Section 5 by Seller (whether requiring a re-study or revision to the IRS or not) shall be borne entirely by Seller and Company shall not be responsible or liable for any delay or failure to meet any such milestones by Seller.

6. Insurance carrier(s): [SELLER TO PROVIDE INFORMATION]
7. If Seller is not the operator, Seller shall provide a copy of the agreement between Seller and the operator which requires the operator to operate the Facility and which establishes the scope of operations by the operator and the respective rights of Seller and the operator with respect to the sale of electric energy from Facility no later than the Commercial Operations Date. In addition, Seller shall provide a certified copy of a certificate warranting that the operator is a corporation, partnership or limited liability company in good standing with the Hawai'i Department of Commerce and Consumer Affairs no later than the Commercial Operations Date.
8. Seller shall provide a certified copy of a certificate warranting that Seller is a corporation, partnership or limited liability company in good standing with the Hawai'i Department of Commerce and Consumer Affairs which shall be attached hereto as Exhibit A-1 (Good Standing Certificates).
9. Seller, owner and operator shall provide Company a certificate and/or description of their ownership structures which shall be attached hereto as Exhibit A-2 (Ownership Structure).
10. In the event of a change in ownership or identity of Seller, owner or operator, such entity shall provide within 30 Days thereof, a certified copy of a new certificate and a revised ownership structure.

EXHIBIT A-1
GOOD STANDING CERTIFICATES

EXHIBIT A-2
OWNERSHIP STRUCTURE

**[ATTACHMENT B WILL BE REVISED TO REFLECT
THE RESULTS OF IRS]**

ATTACHMENT B
FACILITY OWNED BY SELLER

1. The Facility.

(a) Drawings, Diagrams, Lists, Settings and As-Builts.

- (i) Single-Line Drawing, Interface Block Diagram, Relay List, Relay Settings and Trip Scheme. A preliminary single-line drawing (including notes), Interface Block Diagram, relay list, relay settings, and trip scheme of the Facility shall, after Seller has obtained prior written consent from Company, be attached to this Agreement on the Execution Date as Attachment E (Single-Line Drawing and Interface Block Diagram) and Attachment F (Relay List and Trip Scheme). A final single-line drawing (including notes), Interface Block Diagram, relay list and trip scheme of the Facility shall, after having obtained prior written consent from Company, be labeled "Final" Single-Line Drawing, the "Final" Interface Block Diagram and "Final" Relay List and Trip Scheme and shall supersede Attachment E (Single-Line Drawing and Interface Block Diagram) and Attachment F (Relay List and Trip Scheme) to this Agreement and shall be made a part hereof on the Commercial Operations Date. After the Commercial Operations Date, no changes shall be made to the "Final" Single-Line Drawing, the "Final" Interface Block Diagram and the "Final" Relay List and Trip Scheme without the prior written consent of Seller and Company. The single-line drawing shall expressly identify the Point of Interconnection of Facility to Company System.
- (ii) As-Builts. Seller shall provide final as-built drawings of the Seller-Owned Interconnection Facilities within 30 Days of the successful completion of the Acceptance Test.

(iii) No Material Changes. Seller agrees that no material changes or additions to Facility as reflected in the "Final" Single-Line Drawing (including notes), the "Final" Interface Block Diagram and the "Final" Relay List and Trip Scheme, shall be made without Seller first having obtained prior written consent from Company. The foregoing are subject to changes and additions as part of any Performance Standards Modifications. If Company directs any changes in or additions to the Facility, records and operating procedures that are not part of any Performance Standards Modifications, Company shall specify such changes or additions to Seller in writing, and, except in the case of an emergency, Seller shall have the opportunity to review and comment upon any such changes or additions in advance.

(b) Certain Specifications for the Facility.

(i) Seller shall furnish, install, operate and maintain the Facility including breakers, relays, switches, synchronizing equipment, monitoring equipment and control and protective devices approved by Company as suitable for parallel operation of the Facility with Company System. The Facility shall be accessible at all times to authorized Company personnel.

(ii) The Facility shall include:

[LIST OF THE FACILITY

Examples may include, but not limited to:

- **Seller-Owned Interconnection Facilities**
- **Substation**
- **Control and monitoring facilities**
- **Transformers**
- **Generators (as described in Attachment A)**
- **"lockable" cabinets or housings suitable for the installation of the Company-Owned Interconnection Facilities located on the Site**
- **relays and other protective devices**

- **leased telephone line and/or equipment to facilitate microwave communication]**

(iii) The Facility shall comply with the following **[includes excerpts of language that may be requested by Company]**:

- A. Seller shall install a ____ kV disconnect switch and all other items for its switching station (relaying, control power transformers, high voltage circuit breaker). Bus connection shall be made to a manually and automatically (via protective relays) operated high-voltage circuit breaker. The high-voltage circuit breaker shall be fitted with bushing style current transformers for metering and relaying. Downstream of the high-voltage circuit breaker, a structure shall be provided for metering transformers. From the high-voltage circuit breaker, another bus connection shall be made to another pole mounted disconnect switch, with surge protection.
- B. Seller shall provide within the Seller-Owned Interconnection Facilities a separate, fenced area with separate access for Company. Seller shall provide all conduits, structures and accessories necessary for Company to install the Revenue Metering Package. Seller shall also provide within such area, space for Company to install its communications, supervisory control and data acquisition ("SCADA") remote terminal unit ("RTU") and certain relaying if necessary for the interconnection. Seller shall also provide AC and DC source lines as specified later by Company. Seller shall provide a telephone line for Company-owned meters. Seller shall work with Company to determine an acceptable location and size of the fenced-in area. Seller shall provide an acceptable demarcation cabinet on its side of the

fence where Seller and Company wiring will connect/interface.

- C. Seller shall ensure that the Seller-Owned Interconnection Facilities has a lockable cabinet for switching station relaying equipment. Seller shall select and install relaying equipment acceptable to Company. At a minimum the relaying equipment will provide over and under frequency (81) negative phase sequence (46), under voltage (27), over voltage (59), ground over voltage (59G), over current functions (50/51) and direct transfer trip. Seller shall install protective relays that operate a lockout relay, which in turn will trip the main circuit breaker.
- D. Seller shall configure the relay protection system to provide overpower protection to enable Facility to comply with the Allowed Capacity limitation.
- E. Seller's equipment also shall provide at a minimum:
 - (i) Interface with Company's RTU to provide telemetry of electrical quantities such as total Facility net MW, MVar, power factor, voltages, currents, and other quantities as identified by the Company;
 - (ii) Interface with Company's RTU to provide status for circuit breakers, reactive devices, switches, and other equipment as identified by the Company;
 - (iii) Interface with Company's RTU to provide control to incrementally raise and lower the voltage target at the point of regulation operating in automatic voltage regulation control. If Company's RTU is

unavailable, due to loss of communication link, RTU failure, or other event resulting in loss of the remote control by Company, provision must be made for Seller to be able to institute via local controls, within 30 minutes (or such other period as Company accepts in writing) of the verbal directive by the Company System Operator, such change in voltage regulation target as directed by the Company System Operator;

- (iv) Interface with Company's RTU to provide active power control to incrementally limit net real power export from the Facility and to incrementally remove the limit of the net real power export of the Facility. The incremental size will be determined as part of the Interconnection Requirements Study taking into account the size of the Facility and the dynamic system frequency bias; and
- (v) For Wind Facilities: Interface with Company's RTU to provide telemetry of turbine availability and meteorological and production data required under Section 8 (Data and Forecasting) of this Attachment B (Facility Owned by Seller) and the Facility's Power Possible.

F. If Seller adds, deletes and/or changes any of its equipment, or changes its design in a manner that would change the characteristics of the equipment and specifications used in the IRS, Seller shall be required to obtain Company's prior written approval. If an

analysis to revise parts of the IRS is required, Seller shall be responsible for the cost of revising those parts of the IRS, and modifying and paying for the cost of the modifications to the Facility and/or the Company-Owned Interconnection Facilities based on the revisions to the IRS.

G. Critical Infrastructure Protection.

(i) Documentation. Seller shall submit documentation describing the approach, methodology and design to provide physical and cyber security with its submittal of the design drawings pursuant to Section 1(c) (Design Drawings, Bill of Materials, Relay Settings and Fuse Selection) of Attachment B (Facility Owned by Seller) which shall be at least sixty (60) Days prior to the Acceptance Test.

- The design shall meet industry standards and best practices, as indicated by NERC CIP guidelines and requirements for critical generation facilities. The system shall be designed with the criteria to meet applicable industry standards and guidelines (at the time of this writing, NERC CIP, or any future standard adopted by the industry in its place) compliance requirements and identify areas that are not consistent with NERC CIP guidelines and requirements.
- The cyber-security documentation shall include a block diagram of the control system with all external connections clearly described.
- Seller shall provide such additional information as Company may reasonably request as part of a

security posture assessment.

- Company shall be notified in advance when there is any condition that would compromise physical or cyber security, or if any breaches in security, or security incidents are detected.

(ii) Malware. Seller shall (consistent with the following sentence) ensure that no malware or similar items are coded or introduced into any aspect of the Facility, Interconnection Facilities, the Company Systems interfacing with the Facility and Interconnection Facilities, and any of Seller's critical control systems or processes used by Seller to provide energy, including the information, data and other materials delivered by or on behalf of Seller to Company, (collectively, the "Environment"). Seller will continue to review, analyze and implement improvements to and upgrades of its Malware prevention and correction programs and processes that are commercially reasonable and consistent with the then current technology industry's standards and, in any case, not less robust than the programs and processes implemented by Seller with respect to its own information systems. If Malware is found to have been introduced into the Environment, Seller will promptly notify Company and Seller shall take immediate action to eliminate and remediate the effects of the Malware, at Seller's expense. Seller shall not modify or otherwise take corrective action with respect to the Company Systems except at Company's request. Seller

will promptly report to Company the nature and status of all Malware elimination and remediation efforts.

(iii) Security Breach. In the event that Seller discovers or is notified of a breach, potential breach of security, or security incident at Seller's Facility or of Seller's systems, Seller shall immediately (i) notify Company of such potential, suspected or actual security breach, whether or not such breach has compromised any of Company's confidential information, (ii) investigate and promptly remediate the effects of the breach, whether or not the breach was caused by Seller, (iii) cooperate with Company with respect to any such breach or unauthorized access or use; (iv) comply with all applicable privacy and data protection laws governing Company's or any other individual's or entity's data; and (v) to the extent such breach was caused by Seller, provide Company with reasonable assurances satisfactory to Company that such breach, potential breach, or security incident shall not recur. Seller shall provide documentation to Company evidencing the length and impact of the breach. Any remediation of any such breach will be at Seller's sole expense.

(iv) Monitoring and Audit. Seller's shall provide information on available audit logs and reports relating to cyber and physical and security. Company may audit Seller's records to ensure Seller's compliance with the terms of this Section 1(b)(iii)G (Critical Infrastructure Protection) of this Attachment B (Facility Owned by

Seller), provided that Company has provided reasonable notice to Seller and any such records of Seller's will be treated by Company as confidential.

H. Because a reliable Power Possible value under Section 1(b)(iii)(E)(v) of this Attachment B (Facility Owned by Seller) is necessary throughout the Term in order for Company to effectively optimize the benefits of its right of Company Dispatch, it is the expectation of the Parties that the model and data inputs used by the Seller to calculate Power Possible will be validated during the Evaluation Periods described below as more fully set forth below.

(i) The relationship between the 10-minute averaged Power Possible value and the Facility's 10-minute averaged actual power production at the Point of Interconnection shall be evaluated in 10-minute intervals for periods described below. The periods eligible for such evaluation (each such period an "Eligible Period") are periods during which both of the following conditions continuously apply for a duration of not less than 60 consecutive minutes: (aa) the Facility is in Full Dispatch; and (bb) the Measured Wind Speed is within the following range (the "Evaluation Range"): not less than 1 m/s below the manufacturer's specified cut-in-wind speed and not more than 1.5 times the wind speed specified by the manufacture as associated with 85% of the rated power of the WTGS(s). For avoidance of doubt, the aforementioned 60-minute

minimum is not a cap on the duration of an Eligible Period, which shall continue for as long as the two conditions set forth in the preceding sentence continuously apply. Each period for which the relationship between the 10-minute averaged Power Possible value and the 10-minute averaged actual power production will be evaluated (each such period an "Evaluation Period") shall commence 10 minutes after the commencement of the Eligible Period in question and shall consist of all of the consecutive 10-minute intervals that are encompassed within the balance of such Eligible Period. For avoidance of doubt: (i) if an Eligible Period commences because the Measured Wind Speed enters the Evaluation Range (i.e., the Facility was already in Full Dispatch at the time the Measured Wind Speed entered the Evaluation Range), such Evaluation Period shall commence 10 minutes after the Measured Wind Speed enters the Evaluation Range; and (ii) if an Eligible Period commences because the Facility's set point is increased to not less than the Allowed Capacity, such Evaluation Period shall commence 10 minutes after such change in set point;

- (ii) An Evaluation Period shall constitute a Power Possible Discrepancy Period if, for any one or more 10-minute intervals during such Evaluation Period,

the 10-minute averaged Power Possible value for such interval is outside of a band of plus or minus 4% of the 10-minute averaged actual power production at the Point of Interconnection for that same interval.

- (iii) Upon the occurrence of a Power Possible Discrepancy Period, Seller shall promptly investigate the reason why the bandwidth was exceeded, take such action as may be necessary to improve Seller's model and data inputs for calculating Power Possible with the objective of avoiding future Power Possible Discrepancy Periods, and provide to Company, within thirty (30) Days of the occurrence of the Power Possible Discrepancy Period in question, a written report of both the results of such investigation and the action taken by Seller.

- (iv) If, at any time during the Term, four consecutive Evaluation Periods each constitute a Power Possible Discrepancy Period: (aa) the model and data inputs used by Seller to calculate Power Possible shall be considered to be invalidated and the Parties shall promptly commission a study to be performed by one of the engineering firms then included on the OEPR Consultants List to evaluate the cause of the Power Possible Discrepancy Periods and to make recommendations

with the objective of avoiding future Power Possible Discrepancy Periods ("Study"); and (bb) if the Company decides that its ability to effectively optimize the benefits of its right of Company Dispatch is materially impaired by the lack of a validated Power Possible model and data inputs, the Company shall have the right to derate the Facility and the Facility shall be deemed to be in Seller-Attributable Non-Generation status until the Study has been completed and the Study's recommendations have been implemented by Seller to Company's reasonable satisfaction. Seller shall pay for the cost of the Study. The Study shall be completed within ninety (90) days from such fourth consecutive Power Possible Discrepancy Period, unless otherwise agreed to in writing by Seller and Company. The Consultant shall send the Study to Company and Seller. Seller (and/or its Third-Party consultants and contractors), at Seller's expense, shall take such action as the Study shall recommend (e.g., modifications to the model, modifications and/or additions to the data inputs used in the model, modifications to the procedures for maintaining and/or recalibrating the Monitoring and Communication Equipment used to provide data inputs, replacement of such Monitoring and Communication Equipment, modifications of procedures for Facility

operations) with the objective of avoiding future Power Possible Discrepancy Periods. Such recommendations shall be implemented by Seller to Company's reasonable satisfaction no later than forty-five (45) Days from the Day the completed Study is issued by the consultant, unless otherwise agreed to in writing by Company.

I. Seller shall reserve space within the Site for possible future installation of Company-owned meteorological equipment (such as wind speed, direction and relative humidity monitors) and AC and DC source lines for such equipment. In the event Company decides to install such meteorological equipment: (i) Seller shall work with Company to determine an acceptable location for such equipment and any associated wiring, interface or other components; and (ii) Company shall pay for the needed equipment, and installation of such equipment, unless otherwise agreed to by the Parties. Company and Seller shall use commercially reasonable efforts to facilitate installation and minimize interference with the operation of the Facility.

J. The Facility shall, at a minimum, satisfy the wind load and seismic load requirements of the International Building Code and any more stringent requirements imposed under applicable Laws.

(c) Design Drawings, Bill of Materials, Relay Settings and Fuse Selection. Seller shall provide to Company for its review the design drawings, Bill of Material, relay settings and fuse selection for the Facility and Company shall have the right, but not the obligation, to specify the type of electrical equipment, the interconnection wiring, the type of protective relaying equipment, including, but not

limited to, the control circuits connected to it and the disconnecting devices, and the settings that affect the reliability and safety of operation of Company's and Seller's interconnected system. Seller shall provide the relay settings, fuse selection, and AC/DC Schematic Trip Scheme (part of design drawings) for the Facility to Company at least sixty (60) Days prior to the Acceptance Test. Company, at its option, may, with reasonable frequency, witness Seller's operation of control, synchronizing, and protection schemes and shall have the right to periodically re-specify the settings. Seller shall utilize relay settings prescribed by Company, which may be changed over time as Company System requirements change.

- (d) Disconnect Device. Seller shall provide a manually operated disconnect device which provides a visible break to separate Facility from Company System. Such disconnect device shall be lockable in the OPEN position and be readily accessible to Company personnel at all times.

- (e) Other Equipment. Seller shall install, own and maintain the infrastructure associated with the Revenue Metering Package, including but not limited to all enclosures (meter cabinets, meter pedestals, meter sockets, pull boxes, and junction boxes, along with their grounding/bonding connections), CT/PT mounting structures, conduits and ductlines, enclosure support structures, ground buses, pads, test switches, terminal blocks, isolation relays, telephone surge suppressors, and analog phone lines (one per meter), subject to Company's review and approval. **[COMPANY TO REVISE THIS SECTION 1(E) PRIOR TO EXECUTION FOR SPECIFICS OF THE PROJECT.]**

- (f) Maintenance Plan. Seller shall maintain Seller-Owned Interconnection Facilities in accordance with the following maintenance plan:

Transmission line:

kV Facility switching station:

Relay protection equipment:

Other equipment as identified:

Seller shall furnish to Company a copy of records documenting such maintenance, within thirty (30) Days of completion of such maintenance work.

(g) Active Power Control Interface.

- (i) Seller shall provide and maintain in good working order all equipment, computers and software associated with the control system (the "Active Power Control Interface") necessary to interface the Facility active power controls with the Company System Operations Control Center for real power control of the Facility by the Company System Operator. The Active Power Control Interface will be used to control the maximum level of the net real power export from the Facility when required under this Attachment B (Facility Owned by Seller). The implementation of the Active Power Control Interface will allow Company System Operator to initiate the active power limiting, vary the level of limiting, and remove the limiting remotely from Company System Operations Control Center through control signals from Company's SCADA and EMS systems.
- (ii) Company shall review and provide prior written approval of the design for the Active Power Control Interface to ensure compatibility with Company's SCADA and EMS systems. In order to ensure such continued compatibility, Seller shall not materially change the approved design without Company's prior review and prior written approval.
- (iii) The Active Power Control Interface shall include, but not be limited to, a demarcation cabinet, ancillary equipment and software necessary for Seller to connect to Company's RTU, located in Company's portion of the Facility switching station which shall provide the control signals to the Facility and send feedback status to the Company System Operations Control Center. The

control type shall be analog output (set point) controls.

- (iv) The Active Power Control Interface shall also include provision for feedback points from the Facility indicating when active power limiting is in effect and the analog value of the MW limit(s). The Facility shall provide the feedback to the Company SCADA system within 2 seconds of receiving the respective control signal from the Company.
- (v) Seller shall provide an analog input to the RTU for the MW output of the individual generating units, and an analog signal for the total MW output at the Point of Interconnection.
- (vi) The Active Power Control Interface shall provide for remote control of the real-power output of the Facility by the Company at all times. If the Active Power Control Interface is unavailable or disabled, the Facility shall not export electric energy to Company, unless the Company, in its sole discretion, agrees to accept electric energy and Seller and Company agree on an alternate means of dispatch. Notwithstanding the foregoing, if Seller fails to provide such remote control features (whether temporarily or throughout the Term) and fails to discontinue exporting electric energy to Company as required by this Section 1(g)(vi), then, notwithstanding any other provision of this Attachment B (Facility Owned by Seller), Company shall have the right to derate or disconnect the entire Facility during those periods that such control features are not provided.
 - If all local and remote active power controls become unavailable or fail, the Facility shall immediately disconnect from the Company's System.
 - If the direct transfer trip is unavailable due to loss of communication link, RTU failure, or other event

resulting in the loss of the remote control by the Company, provision must be made for the Seller to trip the main circuit breaker.

(vii) The rate at which the Facility changes net real power export shall not exceed the ramp rate specified in Section 3(c) (Ramp Rate) of Attachment B (Facility Owned by Seller). The Facility's Active Power Control Interface will control the rate at which electric energy is changed to achieve the active power limit. The Facility will respond to the active power control request immediately. **[THESE REQUIREMENTS MAY BE CHANGED BY COMPANY FOLLOWING COMPLETION OF THE IRS]**

(viii) The Active Power Control Interface shall accept the following active power control(s) from the Company SCADA and EMS systems:

- **Maximum Power Limit:** The Facility is not allowed to exceed this setting under any circumstances. The frequency response control specified in Section 3(m) (Frequency Response) of Attachment B (Facility Owned by Seller) is not allowed to increase the Facility's net real power export above this limit. When the Maximum Power Limit is set to zero, the Facility's WTGS(s) must be shutdown. **[Applicability subject to Company review].**
- **Power Reference Limit:** The Facility is not allowed to exceed this setting when system frequency is at 60 Hz. When system frequency is not 60 Hz, the Facility's net real power export is allowed to exceed this setting or be further reduced below this setting when commanded by the frequency response control specified in Section 3(m) of Attachment B (Facility Owned by Seller).

(ix) Seller shall not override Company's active power controls without first obtaining specific approval to do so from the Company System Operator.

(x) The requirements of the Active Power Control Interface may be modified as mutually agreed upon in writing by the Parties.

(h) Control System Acceptance Test Procedures.

(i) Conditions Precedent. The following conditions precedent must be satisfied prior to the conduct of the Control System Acceptance Test:

- Successful Completion of the Acceptance Test.
- Facility has been successfully energized.
- All of the Facility's generators have been fully commissioned.
- The control system computer has been programmed for normal operations.
- All equipment that is relied upon for normal operations (including ancillary devices such as capacitors/inductors, energy storage device, statcom, etc.) shall have been commissioned and be operating within normal parameters.

(ii) Facility Generators. Unless all of the Facility's generators are available for the duration of the Control System Acceptance Test, the Control System Acceptance Test will have to be re-run from the beginning unless Seller demonstrates to the satisfaction of the Company that the test results attained with less than all of the Facility's generators are consistent with the results that would have been attained if all of the Facility's generators had been available for the duration of the test.

(iii) Procedures. The Control System Acceptance Test will be conducted on Business Days during normal working hours on a mutually agreed upon schedule. No Control System Acceptance Test will be scheduled during the final 21 Days of a calendar year. No later than thirty (30) Days prior to conducting the Control System Acceptance Test, Company and Seller shall agree on a written protocol setting out the detailed procedure and criteria for passing the Control System Acceptance Test. Attachment O (Control System Acceptance Test Criteria) provides

general criteria to be included in the written protocol for the Control System Acceptance Test. Within fifteen (15) Business Days of completion of the Control System Acceptance Test, Company shall notify Seller in writing whether the Control System Acceptance Test(s) has been passed and, if so, the date upon which such Control System Acceptance Test(s) was passed. If any changes have been made to the technical specifications of the Facility or the design of the Facility in accordance with Section 5(f) of Attachment A (Description of Generation and Conversion Facility), such changes shall be reflected in an amendment to this Agreement, and the written protocol for the Control Systems Acceptance Test shall be based on the Facility as modified. Such Amendment shall be executed prior to conducting the Control System Acceptance Test and Company shall have no obligation for any delay in performing the Control Systems Acceptance Test due to the need to complete and execute such amendment.

- (i) Facility Security and Maintenance. Seller is responsible for securing the Facility. Seller shall have personnel available to respond to all calls related to security incidents and shall take commercially reasonable efforts to prevent any security incidents. Seller is also responsible for maintaining the Facility, including vegetation management, to prevent security breaches. Seller shall comply with all commercially reasonable requests of Company to update security and/or maintenance if required to prevent security breaches.
- (j) Demonstration of Facility. Company shall have the right at any time, other than during maintenance or other special conditions communicated by Seller, to notify Seller in writing of Seller's failure, as observed by Company and set forth in such written notice, to meet the operational and performance requirements specified in Section 1(g) (Active Power Control Interface) and Section 3 (Performance Standards) of this Attachment B (Facility Owned by Seller), and to require documentation or testing to verify compliance with such requirements. Upon

receipt of such notice, Seller shall promptly investigate the matter, implement corrective action and provide to Company, within thirty (30) Days of such notice, a written report of both the results of such investigation and the corrective action taken by Seller. If the Seller's report does not resolve the issues to Company's reasonable satisfaction, the Parties shall promptly commission a study to be performed by one of the engineering firms then included on the OEPR Consultants List to evaluate the cause of the non-compliance and to make recommendations to remedy such non-compliance. Seller shall pay for the cost of the study. The study shall be completed within ninety (90) days, unless otherwise agreed to in writing by Seller and Company. The consultant shall send the study to Company and Seller. Seller (and/or its Third-Party consultants and contractors), at Seller's expense, shall take such action as the study shall recommend with the objective of resolving the non-compliance. Such recommendations shall be implemented by Seller to Company's reasonable satisfaction no later than forty-five (45) Days from the Day the completed study is issued by the consultant, unless otherwise agreed to in writing by Company. Failure to implement such recommendations within this period shall constitute a material breach of this Agreement.

2. Operating Procedures. **[NOTE: NUMERICAL SPECIFICATIONS IN THIS SECTION 2 MAY VARY DEPENDING ON THE SPECIFIC PROJECT AND THE RESULTS OF THE PROJECT SPECIFIC INTERCONNECTION REQUIREMENT STUDY.]**

- (a) Reviews of the Facility. Company may require periodic reviews of the Facility, maintenance records, available operating procedures and policies, and relay settings, and Seller shall implement changes Company deems necessary for parallel operation or to protect the Company System from damages resulting from the parallel operation of the Facility with the Company System.
- (b) Separation. Seller must separate from Company System whenever requested to do so by the Company System Operator pursuant to Article 8 (Company Dispatch) and Article 9 (Personnel and System Safety) of the Agreement.

- (c) Seller Logs. Logs shall be kept by Seller for information on unit availability including reasons for planned and forced outages; circuit breaker trip operations, relay operations, including target initiation and other unusual events. Company shall have the right to review these logs, especially in analyzing system disturbances. Seller shall maintain such records for a period of not less than six (6) years.
- (d) Reclosing. Under no circumstances shall Seller, when separated from the Company System for any reason, reclose into the Company System without first obtaining specific approval to do so from the Company System Operator.
- (e) Reserved.
- (f) Reserved.
- (g) Critical Infrastructure Protection. Seller shall comply with the critical infrastructure protection requirements set forth in Section 1(b)(iii)G of this Attachment B (Facility Owned by Seller).
- (h) Allowed Operations. Facility shall be allowed to export energy to the Company System only when the [_____] circuit is in normal operating configuration served by breaker [_____] at [_____] Substation. **[TO BE DETERMINED BY COMPANY BASED ON THE RESULTS AND REQUIREMENTS OF THE IRS]**

3. Performance Standards.

- (a) Reactive Power Control. Seller shall control its reactive power by automatic voltage regulation control. Seller shall automatically regulate voltage at a point, the point of regulation, between the Seller's generator terminal and the Point of Interconnection to be specified by Company, to within 0.5% of a voltage specified by the Company System Operator to the extent allowed by the Facility reactive power capabilities as defined in Section 3(b) (Reactive Amount) of this Attachment B (Facility Owned by Seller). **[FOR FACILITIES CONNECTED TO THE DISTRIBUTION SYSTEM, THESE REQUIREMENTS MAY BE CHANGED BY COMPANY UPON COMPLETION OF THE IRS.]**
- (b) Reactive Amount. **[THESE REQUIREMENTS MAY BE CHANGED BY COMPANY UPON COMPLETION OF THE IRS.]**

- (i) Seller shall install sufficient equipment so that each [REDACTED] kVA **WTGS** online at the Facility will have the ability to deliver or receive, at its terminal, reactive power as illustrated in the **[generator capability]** curve[s] attached to this Agreement as Exhibit B-2 (Generator Capability Curve(s)). **[NOTE: THE IRS WILL DETERMINE IF ANY ADDITIONAL REACTIVE POWER RESOURCES WILL BE REQUIRED.]**
- (ii) The Facility shall contain equipment able to continuously and actively control the output of reactive power under automatic voltage regulation control reacting to system voltage fluctuations. The automatic voltage regulation response speed at the point of regulation shall be such that at least 90% of the initial voltage correction needed to reach the voltage control target will be achieved within 1 second following a step change.
- (iii) If the Facility does not operate in accordance with Section 3(b)(i) of this Attachment B (Facility Owned by Seller), Company may disconnect all or a part of Facility from Company System until Seller corrects its operation (such as by installing capacitors at Seller's expense).
- (c) Ramp Rates.
- (i) Seller shall ensure that the ramp rate of the Facility is less than the following limits for all conditions including start up, normal operations, Seller adjusting the Facility's net real power export, changes in the **wind** resource, and shut down (including high wind speed shut down in the case of wind facilities) for the following periods as calculated in accordance with Attachment C (Methods and Formulas For Measuring Performance Standards).
- Maximum Ramp Rate Upward of [REDACTED] MW/minute for all periods. **[TO BE DETERMINED FOLLOWING IRS.]**
 - Maximum Ramp Rate Downward of 2 MW/minute for all periods other than periods for which such maximum is not operationally possible because of rapid loss of **wind** resource.

(ii) Upon receiving a command from the Company active power limit control(s) described in Section 1(g)(viii) of this Attachment B (Facility Owned by Seller), Seller shall adjust the Facility's net real power export at a ramp rate, as calculated in accordance with Attachment C (Methods and Formulas for Measuring Performance Standards), to be specified by the Company to the extent allowed by the **wind** resource without exceeding such ramp rate and without intentional delay. Such ramp rate shall be in the range of MW/min to MW/min.

(iii) The Facility is allowed to exceed the maximum ramp rate limits in Section 3(c) (Ramp Rates) of this Attachment B (Facility Owned by Seller) when Facility output is changed by the frequency response control described in Section 3(m) (Frequency Response) of this Attachment B (Facility Owned by Seller).

(d) Reserved.

(e) Undervoltage Ride-Through.

The Facility, as a whole, will meet the following undervoltage ride-through requirements during low voltage affecting one or more of the three voltage phases ("V" is the voltage of any three voltage phases at the Point of Interconnection). **[THESE VALUES MAY BE CHANGED BY COMPANY UPON COMPLETION OF THE IRS. WITHOUT LIMITATION, FOR A DISTRIBUTION-CONNECTED FACILITY, UPON COMPLETION OF THE IRS THE COMPANY MAY SPECIFY REQUIREMENTS FOR A MANDATORY DISCONNECTION FROM THE COMPANY SYSTEM.]**:

0.88 pu \leq V \leq 1.00 pu The Facility remains connected to the Company System.

0.70 pu \leq V $<$ 0.88 pu The Facility may initiate disconnection from the Company System if the voltage remains in this range for more than 20 seconds.

- 0.50 pu \leq V < 0.70 pu The Facility may initiate disconnection from the Company System if the voltage remains in this range for more than 10 seconds.
- 0.00 pu \leq V < 0.50 pu The Facility may disconnection from the Company System if voltage remains in this range for more than 600 milliseconds.

Seller shall have sufficient capacity to fulfill the above mentioned requirements to ride-through the following sequences or combinations thereof **[THE ACTUAL CLEARING TIMES WILL BE DETERMINED BY COMPANY IN CONNECTION WITH THE IRS]:**

- Normally cleared 138 kV transmission faults cleared after 5 cycles with one reclose attempt, cleared in 5 cycles, 30 cycles after the initial fault was cleared. The voltage at the Point of Interconnection will recover above the 0.80 p.u. level for the 30 cycles between the initial clearing time and the reclosing time.
- Normally cleared 46kV subtransmission faults cleared in 7 cycles with one reclose attempt, cleared in 7 cycles, 23 cycles after the initial fault was cleared. The voltage at the Point of Interconnection will recover above the 0.80 p.u. level for the 23 cycles between the initial clearing time and the reclosing time.

(f) Over Voltage Ride-Through.

The overvoltage protection equipment at the Facility shall be set so that the Facility will meet the following overvoltage ride-through requirements during high voltage affecting one or more of the three voltage phases (as described below) ("V" is the voltage of any of the three voltage phases at the Point of Interconnection). **[THESE VALUES MAY BE CHANGED BY THE COMPANY UPON COMPLETION OF THE IRS. WITHOUT LIMITATION, FOR A DISTRIBUTION-CONNECTED FACILITY, UPON COMPLETION OF THE IRS THE COMPANY MAY SPECIFY REQUIREMENTS FOR A MANDATORY DISCONNECTION FROM THE COMPANY SYSTEM AT V >**

**1.2 pu. RIDE-THROUGH REQUIREMENTS FOR OTHER SYSTEMS
WILL BE DETERMINED IN THE IRS.]:**

1.00 pu < V ≤ 1.10 pu The Facility remains connected to the Company System.

1.10 pu < V ≤ 1.20 pu The Facility may initiate disconnection from the Company System if voltage remains in this range for more 0.92 seconds.

V > 1.2 pu The Facility may initiate disconnection from the Company System immediately.

(g) [RESERVED]

(h) Fault Ride Through.

For fault-related voltage dips at the Point of Interconnection that stay within the limits of the under voltage ride-through requirements in Section 3(e) (Undervoltage Ride Through) of this Attachment B (Facility Owned by Seller), upon clearing of the fault, Seller shall within 1 second of restoration, provide at least 90% of the real power output at the Point of Interconnection immediately before the fault without regard to the ramp rate requirements of Section 3(c) (Ramp Rates) of this Attachment B (Facility Owned by Seller) to the extent allowed by the availability of the **wind** resource. The fault ride through requirement does not apply if the Facility is operating at less than five percent (5%) of the Facility's nameplate capacity.

(i) Underfrequency ride-through.

The Facility shall meet the following underfrequency ride-through requirements during an underfrequency disturbance ("f" is the Company System frequency at the Point of Interconnection):

57.0 Hz ≤ f ≤ 60.0 Hz The Facility remains connected to the Company System.

56.0 Hz ≤ f ≤ 57.0 Hz The Facility may initiate disconnection from the Company

System if frequency remains in this range for more than 20 seconds.

$f < 56.0 \text{ Hz}$

The Facility may initiate disconnection from the Company System immediately.

(j) Overfrequency ride-through.

The Facility will behave as specified below for overfrequency conditions ("f" is the Company System frequency at the Point of Interconnection):

$60.0 \text{ Hz} \leq f \leq 63.0 \text{ Hz}$

The Facility remains connected to the Company System.

$63.0 \text{ Hz} \leq f \leq 64.0 \text{ Hz}$

The Facility shall initiate disconnection from the Company System if frequency remains in this range for more than 20 seconds.

$f > 64.0 \text{ Hz}$

The Facility shall initiate disconnection from the Company System immediately.

(k) Voltage Flicker.

Any voltage flicker on the Company System caused by the Facility shall not exceed the limits stated in IEEE Standard 1453-2011, or latest version "Recommended Practice - Adoption of IEC 61000-4-15:2010, Electromagnetic compatibility (EMC) - Testing and measurement techniques - Flickermeter - Functional and design specifications".

(l) Harmonics.

Harmonic distortion at the Point of Interconnection caused by the Facility shall not exceed the limits stated in IEEE Standard 519-1992, or latest version "Recommended Practices and Requirements for Harmonic Control in Electrical Power Systems". Seller shall be responsible for the installation of any necessary controls or hardware to limit the voltage and current harmonics generated from the Facility to defined levels.

(m) Frequency Response.

Seller Facility shall provide a primary frequency response with a frequency droop characteristic reacting to system frequency fluctuations at the Point of Interconnection in both the overfrequency and underfrequency directions except to the extent such response is not operationally possible because of the level of available **wind** resource.

- (i) The Facility frequency response control shall adjust, without intentional delay and without regard to the ramp rate limits in Section 3(c) (Ramp Rates) of this Attachment B (Facility Owned by Seller), the Facility's net real power export when system frequency is not 60 Hz based on frequency deadband and frequency droop settings specified by the Company.
- (ii) The Facility frequency response control shall be allowed to increase the net real power export above the Power Reference Limit set under Section 1(g)(viii) of this Attachment B (Facility Owned by Seller) or further decrease the net real power export from the Power Reference Limit in its operations.
- (iii) The frequency deadband shall be settable in the range from +/-0.01 Hz to +/- 0.10 Hz and the frequency droop shall be settable in the range of 0.1% to 10%.
- (iv) The Facility frequency response control shall be in continuous operation when the Facility is exporting energy to the Company unless directed otherwise by the Company.

(n) Inertia Constant.

Synchronous Generator(s) must have an inertia constant (H) between 4 to 6 seconds. **[TO BE REVIEWED BY COMPANY FOLLOWING THE IRS]**

4. Maintenance of Seller-Owned Interconnection Facilities.

- (a) Seller must address any Disconnection (as defined below) according to the requirements of this Section 4 (Maintenance of Seller-Owned Interconnection Facilities) of Attachment B (Facility Owned by Seller). For this purpose, a Disconnection is a disconnection from Company System of at least [REDACTED] MW **[TO BE DETERMINED BY COMPANY FOLLOWING THE IRS]** from the Facility over a "rolling 120-second period", if such disconnection is due to a defect in or a failure of Seller-Owned Interconnection Facilities. A "rolling 120-second period" means a period that is comprised of 120 seconds and such rolling period will change as each new one (1) second elapses. With the elapse of each new one (1) second, the newest one (1) second would be added to the 120-second period, and the oldest one (1) second would no longer be included in the rolling 120-second period.
- (b) For every disconnection from the Company System of at least [REDACTED] MW **[TO BE DETERMINED BY THE COMPANY UPON COMPLETION OF THE IRS]** from Facility over a rolling 120-second period ("Disconnection Event"), Seller shall investigate the cause of the Disconnection Event, and determine if it is a Disconnection as defined in Section 4(a) of this Attachment B (Facility Owned by Seller). Within three (3) Business Days of the Disconnection Event, Seller shall provide, in writing to Company, an incident report that summarizes the sequence of events and probable cause of the Disconnection Event, and states whether the Seller believes the Disconnection Event is a Disconnection.
- (c) Within forty-five (45) Days of a Disconnection, Seller shall provide, in writing to Company, Seller's findings, data relied upon for such findings, and proposed actions to prevent reoccurrence of a Disconnection ("Proposed Actions"). Company may assist Seller in determining the causes of and recommendations to remedy or prevent a Disconnection ("Company's Recommendations"). Seller shall implement such Proposed Actions (as modified to incorporate the Company's Recommendations, if any) and Company's Recommendations (if any) in accordance with the time period agreed to by the Parties.
- (d) In the event Seller and Company disagree as to (i) whether a Disconnection Event occurred, (ii) the sequence of events and/or probable cause of the Disconnection Event, (iii) whether the Disconnection Event is a Disconnection, (iv) the Proposed Actions,

(v) Company's Recommendations, and/or (vi) the time period to implement the Proposed Actions and/or Company's Recommendations, then the Parties shall follow the procedure set forth in Section 5 (Expedited Dispute Resolution) of this Attachment B (Facility Owned by Seller).

- (e) Upon the fourth (4th) Disconnection (and each subsequent Disconnection) within any Contract Year, the Parties shall follow the procedures set forth in Section 4(a) and Section 4(d) of Attachment B (Facility Owned by Seller), to the extent applicable. If after following the procedures set forth in this Section 4 (Maintenance of Seller-Owned Interconnection Facilities) of Attachment B (Facility Owned by Seller), Seller and Company continue to have a disagreement as to (1) the probable cause of the Disconnection, (2) the Proposed Actions, (3) the Company's Recommendations, and/or (4) the time period to implement the Proposed Actions and/or the Company's Recommendations, then the Parties shall commission a study to be performed by a qualified independent Third-Party consultant ("Qualified Consultant") chosen from the Qualified Independent Third-Party Consultants List ("Consultants List") attached to the Agreement as Attachment D (Consultants List). Such study shall review the design of, review the operating and maintenance procedures dealing with, recommend modifications to, and determine the type of maintenance that should be performed on Seller-Owned Interconnection Facilities ("Study"). Seller and Company shall each pay for one-half of the total cost of the Study. The Study shall be completed within ninety (90) Days from such fourth Disconnection (and each subsequent Disconnection) within any Contract Year, unless otherwise agreed to in writing by Seller and Company. The Qualified Consultant shall send the Study to Company and Seller. Seller (and/or its Third-Party consultants and contractors), at Seller's expense, shall change the design of, change the operating and maintenance procedures dealing with, implement modifications to, and/or perform the maintenance on Seller-Owned Interconnection Facilities recommended by the Study. Such design changes, operating and maintenance procedure changes, modifications, and/or maintenance shall be completed no later than forty-five (45) Days from the Day the completed Study is issued by the Qualified Consultant, unless otherwise agreed to in

writing by Company. In the event the time requirement for the (i) commissioning of the Study, (ii) completion of the Study, or (iii) completion of the design change, operating and maintenance procedure change, modifications, and/or maintenance recommended by the Study is not achieved, Company may limit the total Allowed Capacity to a level that maintains reliable operations in accordance with Good Engineering and Operating Practices for the period that such requirement has not been achieved. Nothing in this provision shall affect Company's right to dispatch the Facility as provided for in this Agreement.

- (f) The Consultants List attached hereto as Attachment D (Consultants List) contains the names of engineering firms which both Parties agree are fully qualified to perform the Study. At any time, except when a Study is being conducted, either Party may remove a particular consultant from the Consultants List by giving written notice of such removal to the other Party. However, neither Party may remove a name or names from the Consultants List without approval of the other Party if such removal would leave the list without any names. Intended deletions shall be effective upon receipt of notice by the other Party, provided that such deletions do not leave the Consultants List without any names. Proposed additions to the Consultants List shall automatically become effective thirty (30) Days after notice is received by the other Party unless written objection is made by such other Party within said thirty (30) Day period. By mutual agreement between the Parties, a new name or names may be added to the Consultants List at any time.

5. Expedited Dispute Resolution.

If there is a disagreement between Company and Seller regarding (i) Seller's compliance with the standards set forth in Section 3 (Performance Standards) of this Attachment B (Facility Owned by Seller), and/or (ii) Section 4 (Maintenance of Seller-Owned Interconnection Facilities) of this Attachment B (Facility Owned by Seller) such as (aa) whether a Disconnection Event occurred, (bb) the sequence of events and/or probable cause of the Disconnection Event, (cc) whether the Disconnection Event is a Disconnection, (dd) the Proposed Actions, (ee) the Company's Recommendations, and (ff) the time period to implement the Proposed Actions and/or the Company's Recommendations, then authorized

representatives from Company and Seller, having full authority to settle the disagreement, shall meet in Hawai'i (or by telephone conference) and attempt in good faith to settle the disagreement. Unless otherwise agreed in writing by the Parties, the Parties shall devote no more than five (5) Business Days to settle the disagreement in good faith. In the event the Parties are unable to settle the disagreement after the expiration of the time period, then either Party may pursue the dispute resolution procedure set forth in Article 28 (Dispute Resolution) of this Agreement.

6. Modeling.

(a) Seller's Obligation to Provide Models. Within 30 Days of Company's written request, but no later than the Commercial Operations Date, Seller shall provide detailed data regarding the design and location of the Facility, in a form reasonably satisfactory to Company, to allow the modeling of the WTGS(s) and any other equipment within the Facility identified in the IRS which utilizes Source Code (such as energy storage system, STATCOM or DVAR equipment), including, but not limited to, integrated and validated power flow and transient stability models (such as PSS/E models), a short circuit model (such as an ASPEN model), and an electro-magnetic transient model (such as a PSCAD model) of the WTGS(s) and any additional equipment identified in the IRS as set forth above, applied assumptions, and pertinent data sets (each a "Required Model" and collectively, the "Required Models"). Thereafter, during the Term, Seller shall provide working updates of any Required Model within 30 Days of (i) Company's written request, or (ii) Seller obtaining knowledge or notice that any Required Model has been modified, updated or superseded by the Source Code Owner.

(b) Escrow Establishment. If, pursuant to Section 6(a) (Seller's Obligation to Provide Models) of this Attachment B (Facility Owned by Seller), the Required Models are provided to the Company in a form other than Source Code, Seller shall arrange for and ensure that the Source Code for the relevant Required Model is deposited into the Source Code Escrow as set forth below in Section 6(b)(i) (Source Code Escrow) no later than the time periods set forth in Section 6(a) (Seller's Obligation to Provide Models) for delivery of the Required Models. Seller shall be responsible for all costs associated with establishing and maintaining the Source Code Escrow. If, however, Seller is unable to deposit the required Source Code into the Source Code Escrow within the

time periods set forth in Section 6(a) (Seller's Obligation to Provide Models), Seller shall, no later than such time periods, instead establish a monetary escrow as set forth below in Section 6(b)(ii) (Monetary Escrow) of this Attachment B (Facility Owned by Seller).

(i) Source Code Escrow.

(A) Establishment of Source Code Escrow. If the Required Models are not provided to the Company in the form of Source Code pursuant to Section 6(a) of this Attachment B (Facility Owned by Seller), Seller shall: (a) arrange for and ensure the deposit of a copy of the current version of the Source Code and relevant documentation for all Required Models with the Source Code Escrow Agent under the terms and conditions of the Source Code Escrow Agreement, and (b) arrange for and ensure the update of the deposited Source Code and relevant documentation for Major Releases and Minor Releases of the Required Models as soon as reasonably possible after they are made generally available.

(B) Release Conditions. Company shall have the right to obtain from the Source Code Escrow Agent one copy of the escrowed Source Code for the Required Models, under the following conditions upon Company's request:

(i) A receiver, trustee, or similar officer is appointed, pursuant to federal, state or applicable foreign law, for the Source Code Owner;

(ii) Any voluntary or involuntary petition or proceeding is instituted, under (x) U.S. bankruptcy laws or (y) any other bankruptcy, insolvency or similar proceeding outside of the United States, by or against the Source Code Owner; or

(iii) Failure of the Source Code Owner to function as a going concern or operate in the ordinary course; or

(iv) Seller and the Source Code Owner fail to provide to Company the Required Models or updated Required Models within the time periods set forth in Section 6(a) (Seller's Obligation to Provide Models) of this Attachment B (Facility Owned by Seller), Company gives written notice of such failure to Seller and the Source Code Owner, and Seller and Source Code Owner fail to remedy such breach within five (5) Days following receipt of such notice.

(C) Remedies. If Company has the right to obtain from the Source Code Escrow Agent one copy of the escrowed Source Code for the Required Models pursuant to Section 6(b)(i)(B) (Release Conditions) of Attachment B (Facility Owned by Seller), and Company finds that Seller failed to arrange for and ensure the update the Source Code Escrow with the modified and/or updated Source Code and relevant documentation for Major Releases and Minor Releases of the Required Models as provided in Section 6(b)(i) (Establishment of Source Code Escrow) of Attachment B (Facility Owned by Seller) or that the Source Code for the Required Models is incomplete or otherwise unusable, Seller shall be liable to Company for liquidated damages in the amount of \$500 per day for each day Seller fails to provide such Source Code to Company or such update to the Source Code to Company from the date such Major Release or Minor Release was first made available by the Source Code Owner to customers of the Source Code Owner. Failure to provide the updated Source Code of the Required Models within 30 Days' notice from Company of a breach of Section 6(b)(i)(A) (Establishment of Source Code Escrow) of Attachment B (Facility Owned by Seller) shall constitute an Event of Default pursuant to Section 15.2(F) (Events of Default by a Party) under the Agreement.

(D) Certification. The Source Code Escrow Agent shall release the Source Code of the Required Models to Company upon receipt of a signed statement by a representative of Company that reads substantially as follows:

The undersigned hereby certifies that (i) I am duly authorized to execute this document on behalf of Hawaiian Electric Company, Inc. ("Hawaiian Electric"), and (ii) Hawaiian Electric is entitled to a copy of the Source Code of the Required Models Pursuant to Section 6(b)(i)(B) (Release Conditions) of Attachment B (Facility Owned by Seller) of the Power Purchase Agreement dated as of _____, between _____, and Hawaiian Electric.

(E) Authorized Use. If Company becomes entitled to a release of the Source Code of the Required Models from escrow, Company may thereafter correct, modify, update and enhance the Required Models for the sole purpose of providing itself the support and maintenance it otherwise

would have been entitled to if it had been provided the Required Models by Seller under Section 6(a) (Seller's Obligation to Provide Models) of this Attachment B (Facility Owned By Seller) (the "Source Code Authorized Use").

(F) Confidentiality Obligations. Company shall keep the Source Code of the Required Models confidential pursuant to the confidentiality obligations of the Source Code Escrow Agreement. Company shall restrict access to the Source Code of the Required Models to those employees, independent contractors and consultants of Company who have agreed in writing to be bound by confidentiality and use obligations consistent with those specified in the Escrow Agreement, and who have a need to access the Source Code of the Required Models on behalf of Company to carry out their duties for the Authorized Use. Promptly upon Seller's request, Company shall provide Seller with the names and contact information of all individuals who have accessed the Source Code of the Required Models, and shall take all reasonable actions required to recover any such Source Code in the event of loss or misappropriation, or to otherwise prevent their unauthorized disclosure or use.

(ii) Monetary Escrow.

(A) Establishment of Monetary Escrow. If the Required Models and their relevant Source Code are not provided to the Company in the form of Source Code pursuant to Section 6(a) (Seller's Obligation to Provide Models) of this Attachment B (Facility Owned by Seller) and if the Seller is unable to arrange for and ensure the deposit of the Source Code into the Source Code Escrow established for the benefit of the Company pursuant to Section 6(b)(i) (Source Code Escrow) of this Attachment B (Facility Owned by Seller) then, no later than the time periods set forth in Section 6(a) (Seller's Obligation to Provide Models) of this Attachment B (Facility Owned by Seller) for delivery of the Required Models and Source Code, Seller shall provide an irrevocable standby letter of credit with no documentation requirement in the amount of Two Hundred Fifty Thousand Dollars (\$250,000) per Required Model (and its relevant Source Code) substantially in the form attached to this Agreement as Attachment M (Form of Letter of Credit) from a bank or other financial institution located in the United States with a credit rating of "A-" or better. Such letter of credit shall be issued for a minimum term of one (1) year. Furthermore, at the end of each year the security shall be renewed for an additional one (1) year term so that at the

time of such renewal, the remaining term of any such security shall not be less than one (1) year. The letter of credit shall include a provision for at least thirty (30) Days advance notice to Company of any expiration or earlier termination of the letter of credit so as to allow Company sufficient time to exercise its rights under said security if Seller fails to extend or replace the security. In all cases, the reasonable costs and expenses of establishing, renewing, substituting, canceling, increasing, reducing, or otherwise administering the letter of credit shall be borne by Seller.

(B) Release Conditions. Company shall have the right to draw on the letter of credit the funds necessary to develop and recreate the Required Model or Required Models upon Company's request if Seller fails to provide the Company the Required Models or updated Required Models within the time periods set forth in Section 6(a) (Seller's Obligation to Provide Models) of this Attachment B (Facility Owned by Seller), Company gives written notice of such failure to Seller, and Seller fails to remedy such breach within five (5) days following receipt of such notice.

(C) Extend Letter of Credit. If the letter of credit is not renewed or extended no later than thirty (30) Days prior to its expiration or earlier termination, Company shall have the right to draw immediately upon the full amount of the letter of credit and to place the proceeds of such draw (the "Proceeds"), at Seller's cost, in an escrow account in accordance with Section 6(b)(ii)(D) (Proceeds Escrow), until and unless Seller provides a substitute form of letter of credit meeting the requirements of this Section 6(b)(ii) (Monetary Escrow) of this Attachment B (Facility Owned by Seller).

(D) Proceeds Escrow. If Company draws on the letter of credit pursuant to Section 6(b)(ii)(C) (Extend Letter of Credit) of this Attachment B (Facility Owned by Seller), Company shall, in order to avoid comingling the Proceeds, have the right but not the obligation to place the Proceeds in an escrow account as provided in this Section 6(b)(ii)(D) (Proceeds Escrow) of this Attachment B (Facility Owned by Seller) with a reputable escrow agent acceptable to Company ("Escrow Agent"). Without limitation to the generality of the foregoing, a federally-insured bank shall be deemed to be a "reputable escrow agent." Company shall

have the right to apply the Proceeds as necessary to recover amounts Company is owed pursuant to this Section 6 (Modeling) of this Attachment B (Facility Owned by Seller). To that end, the documentation governing such escrow account shall be in form and content satisfactory to Company and shall give Company the sole authority to draw from the account. Seller shall not be a party to such documentation and shall have no rights to the Proceeds. Upon full satisfaction of Seller's obligations under Section 6 (Modeling) of this Attachment B (Facility Owned by Seller), Company shall instruct the Escrow Agent to remit to the bank that issued the letter of credit that was the source of the Proceeds the remaining balance (if any) of the Proceeds. If there is more than one escrow account with Proceeds, Company may, in its sole discretion, draw on such accounts in any sequence Company may select. Any failure to draw upon the Proceeds for any damages or other amounts due Company shall not prejudice Company's rights to recover such damages or amounts in any other manner.

(E) Seller's Obligation. If the letter of credit is not sufficient to cover Company's associated consultant fees, costs and expenses to develop and recreate the Required Models, Seller shall pay to Company the difference within ten (10) Days of Company's written notice to Seller.

(F) Model Verification. Seller shall work with the Company to validate the new Required Models developed by or on behalf of Company within sixty (60) Days of receiving such new Required Models. Seller shall also arrange for and ensure that Company may obtain new Required Models directly from the Source Code Owner in the event that Seller ceases to operate as a going concern or is subject to voluntary or involuntary bankruptcy and is unable or unwilling to obtain the new Required Models from the Source Code Owner.

(G) Certification. The terms of the letter of credit shall provide for a release of the funds, or in the event the funds have been placed into a Proceeds Escrow, the Escrow Agent shall release the necessary funds to Company upon receipt of a signed statement by a representative of Company that reads substantially as follows:

The undersigned hereby certifies that (i) I am duly authorized to execute this document on behalf of Hawaiian Electric Company, Inc. ("Hawaiian Electric"), and (ii) Hawaiian Electric is entitled to \$ _____, pursuant to Section 6(b)(ii)(B) (Release Conditions) of Attachment B (Facility Owned by Seller) of the Power Purchase Agreement dated as of _____, between _____, and Hawaiian Electric.

(H) Authorized Use. If Company becomes entitled to a release of funds from escrow, Company may thereafter use such funds to develop, recreate, correct, modify, update and enhance the Required Models for the sole purpose of providing itself the support and maintenance it otherwise would have been entitled to if it had been provided the Required Models by Seller under Section 6(a) (Seller's Obligation to Provide Models) of this Attachment B (Facility Owned by Seller) (the "Monetary Authorized Use").

(iii) Supplementary Agreement. The parties stipulate and agree that the escrow provisions in this Attachment B (Facility Owned By Seller), Section 6(b) (Escrow Establishment) and the Source Code Escrow Agreement and Monetary Escrow Agreement are "supplementary agreements" as contemplated in Section 365(n)(1)(B) of the Code. In any voluntary or involuntary bankruptcy proceeding involving Seller, failure by Company to assert its rights to "retain its rights" to the intellectual property encompassed by the Source Code or the funds in the monetary escrow, pursuant to Section 365(n)(1)(B) of the Code, under an executory contract rejected in a bankruptcy proceeding, shall not be construed as an election to terminate the contract by Company under Section 365(n)(1)(A) of the Code.

7. Testing Requirements.

(a) Testing Requirements. Once the Control System Acceptance Test has been successfully passed, Seller shall not replace and/or change the configuration of the Facility Control, **wind turbine controls** and/or ancillary device controls, without prior written notice to Company. In the event of any such replacement and/or change, the relevant test(s) of the Control System Acceptance Test shall be redone and must be successfully passed before the replacement or altered equipment is allowed to be placed in normal operations. In the event

that Company reasonably determines that such replacement and/or change of controls makes it inadvisable for the Facility to continue in normal operations without a further Control Systems Acceptance Test, the Facility shall be deemed to be in Seller-Attributable Non-Generation status until the new relevant tests of the Control System Acceptance Test have been successfully passed.

- (b) Periodic Testing. Seller shall coordinate periodic testing of the Facility with Company to ensure that the Facility is meeting the performance standards specified under this Agreement.

8. Data and Forecasting.

Seller shall provide Site, meteorological and production data in accordance with the terms of Article 6 (Forecasting) of this Agreement and the following requirements:

- (i) Physical Site Data: Seller shall provide Company with an accurate description of the physical Site, including but not limited to the following, which may not be changed during the Term without Company's prior written consent:
- A. Location Facility map showing the layout of the Facility (coverage area or footprint), coordinates (latitude and longitude) and height above ground of each Wind Turbine hub.
 - B. Location (latitude and longitude) of each MMT and elevation (above ground) of each field measurement device for, e.g., air density, ambient air pressure and ambient air temperature, located at each MMT.
- (ii) Meteorological and Production Data:
- A. For facilities with a Contract Capacity greater than 1 MW, Seller shall install and maintain at least one multi-level MMT on the prevailing, upstream side of the Facility to elevate the field measurement devices for the "other meteorological conditions" identified in Section 6.2(ii) of this Agreement. At a minimum, such measuring devices shall be placed at approximately "hub height" of the Wind Turbines, typically using a boom

extension off the MMT. Typically, additional measuring devices for such "other meteorological conditions" shall be placed on boom extensions off the MMT at appropriate heights above and below "hub height" as such "appropriate heights" are agreed to between Company and Seller. For facilities with a Contract Capacity of 5 MW and greater, Company may require Seller to install and maintain additional MMTs and additional field measurement devices.

- B. For purposes of calculating Facility PBAF, the Seller shall provide (i) the wind speed and Actual WTGS Production at each WTGS within the Facility and (ii) the data on the other meteorological conditions (e.g. air density, ambient air pressure and ambient air temperature) at approximately "hub height" at each MMT.
- C. Seller shall provide to Company, via SCADA communication and protocol acceptable to Company to support operations and forecasting needs at a continuous scan, all meteorological and production data required under this Agreement updated every 2 seconds.
- D. For facilities with a Contract Capacity greater than 1 MW, Seller shall arrange for a dedicated 12 kV line to provide separate service from Company, or for such other independent, backup power source as approved by Company in writing, to temporarily store and record the meteorological data from both the nacelle anemometers at the WTGS(s) and the field measuring devices at the MMTs. Any such backup power source must be capable of providing power for the field measurement devices for a reasonable period of time until primary power is restored. The same backup power source can serve multiple MMTs as needed by the Facility.

(iii) Units and Accuracy:

A. Units and accuracy of measured parameters to be provided to Company in real time shall be as shown in the Table below. These represent the minimum required accuracies.

Table of Units and Accuracy of Meteorological and Production Data (Wind)

Parameter	Data Source	Unit	Range	Accuracy
Wind speed at nacelle of each WTGS	Cup or sonic anemometer	mph	0 to 134 mph	+/-1 mph
Wind direction at nacelle of each WTGS	Vane, sonic device or equivalent	Degrees (from True North)	360°	+/-5°
Wind speed at MMT	Cup or sonic anemometer	mph	0 to 134 mph	+/-1 mph
Wind direction at MMT	Vane, sonic device or equivalent	Degrees (from True North)	360°	+/-5°
Ambient air temperature at MMT (hub height)*	Temperature probe	°C	-20 to +50 °C	+/-1 °C
Ambient air pressure at MMT (hub height)*	Piezoresistive transducer, barometer or equivalent	mbar	150 to 1150 mbar	+/-60 mbar (0 to +50°C)
Power production for each WTGS	Measured at WTGS	MW	Up to WTGS name plate	+/-0.1 MW
Set point for each WTGS	Reported by Seller	MW	0 to WTGS name plate	Not applicable
Power production of Facility	Measured at Facility's analog transducers on Seller's side of POI	MW	Up to Allowed Capacity	The lesser of the tolerances of the communication

* Plus such other "appropriate heights" as provided in Section 8(ii) (A) of this Attachment B (Facility Owned by Seller).

				/ telemetry equipment or 2% of measurement
Facility power production ratio	Ratio of Facility's power production (MW) / Allowed Capacity (MW)	%	0 to 100%	+/-0.1%
Power Possible	Seller's Model	MW	0 to Allowed Capacity	+/-4%

(iv) Status of WTGS(s) for Purposes of Calculating Facility PBAF:

For each WTGS, Seller shall, unless agreed otherwise by Company and Seller in writing, provide to Company, via SCADA communication and protocol acceptable to Company at a continuous scan updated not less than frequently every 2 seconds, on each WTGS status itemized below:

- Full Dispatch
- Partial Dispatch
- Non-Generating
- Company Attributable Non-Performance
- Seller-Attributable Non-Performance
- Force Majeure
- Information Unavailable

9. Technology Specific Requirements.

(a) Three-Phase Synchronous Generators.

The generating facility circuit breakers shall be 3-phase devices with electronic or electromechanical control. The Seller shall be responsible for properly synchronizing its generating facility with the Company System by means of either a manual or automatic synchronizing function. Automatic synchronizing is required for all synchronous generators which have an short circuit current rating ("SCCR") greater than 5%. For a generating facility whose SCCR exceeds 5%, the Facility shall provide protective equipment suitable for detecting loss of synchronism and automatically disconnecting the generating facility from the Company

System. Unless otherwise agreed to between the Company and Seller, synchronous generators shall automatically regulate power factor, not voltage, while operating in parallel with the Company System.

(b) Induction Generators.

- (i) Induction generators may be connected and brought up to synchronous speed (as an induction motor) if it can be demonstrated that the initial voltage drop measured at the Point of Interconnection is within the visible flicker limits as defined by IEEE 519-1992 (or latest version). The same requirements also apply to induction generation connected at or near synchronous speed because a similar voltage dip is present due to an inrush magnetizing current. The Facility shall submit number of starts per specific time period and maximum starting kVA draw data for the utility to verify that the voltage dip due to starting is within the visible flicker limits and does not degrade the normal voltage provided by the utility.
- (ii) Induction generators do not require separate synchronizing equipment. Starting or rapid load fluctuations on induction generators can adversely impact the Company System voltage. Corrective step-switched capacitors or other techniques may be necessary if the voltage fluctuations measured at the Point of Interconnection are not within the visible flicker limits as defined by IEEE 519-1992 (or latest version). These measures can, in turn, cause ferroresonance. If these measures (additional capacitors) are installed on Seller's side of the Point of Interconnection, the Company will review these measures and may require Seller to install additional protective relaying equipment. Company will determine whether additional equipment is required to protect the Company System.

(c) Inverter Systems.

- (i) Direct current generators and non-power (i.e. other than 60 Hertz) alternating current generators can only be installed in parallel with the Company System using a non-islanding synchronous inverter. The design shall comply with the requirements of

IEEE Std 1547-2003 (or latest version), except as described in Section 3 (Performance Standards) of this Attachment B (Facility Owned by Seller).

- (ii) Self-commutated inverters of the Company-interactive type shall synchronize to the Company System. Line-commutated, thyristor-based inverters are not recommended and will require additional technical study to determine harmonic and reactive power requirements. All interconnected inverter systems shall comply with the harmonic current limits of IEEE Std 519-1992 (or latest version).

EXHIBIT B-1
REQUIRED MODELS

PSS/E

ASPEN

PSCAD

EXHIBIT B-2
GENERATOR CAPABILITY CURVE(S)

**[ATTACHMENT C WILL BE REVISED TO REFLECT
THE RESULTS OF IRS]**

ATTACHMENT C
METHODS AND FORMULAS FOR MEASURING PERFORMANCE STANDARDS

1. Performance Standards as defined below shall be used, in part, to govern actions by Company to limit the Actual Output of the Facility for purposes of maintaining power quality on Company System. Specific standards are defined for:
 - Ramp Rate (RR)
2. Formulas for measuring the performance standards are presented below, and assume that the power fluctuations will be monitored on the Company's SCADA and EMS systems. These formulas are based on the periodicity at which analog data is retrieved from the RTU. This periodicity is called the "scan rate". Company presently uses a two-second analog scan rate. The formulas below are based on the two-second scans. The transducer used to obtain the instantaneous power (MW) output from a wind farm is accurate to +/- 0.1%. The two-second scan rate, characteristics of transducers and RTU reporting, and SCADA method of calculation, were considered and included in the proposed values for the performance standards.

3. Ramp Rate Calculation:

$$RR = MW_s - MW_{s-30}$$

Where:

RR = Ramp Rate, may be calculated once every scan

MW_{s-30} = The instantaneous MW analog value 30 scans (60 seconds) prior the present scan

MW_s = The instantaneous MW analog value for the present scan

ATTACHMENT D
CONSULTANTS LIST

ATTACHMENT E
SINGLE-LINE DRAWING AND INTERFACE BLOCK DIAGRAM

(To be attached as per Section 1(a) of Attachment B)

ATTACHMENT F
RELAY LIST AND TRIP SCHEME

(To be attached as per Section 1(a) of Attachment B.)

**[ATTACHMENT G SHALL BE REVISED TO REFLECT
THE RESULTS OF IRS]**

ATTACHMENT G
COMPANY-OWNED INTERCONNECTION FACILITIES

1. Description of Company-Owned Interconnection Facilities.

- (a) General. Company shall furnish or construct (or may have Seller furnish or construct, in whole or in part), own, operate and maintain all Interconnection Facilities required to interconnect Company System with Facility at [REDACTED] volts, up to the Point of Interconnection (collectively, the "Company-Owned Interconnection Facilities").
- (b) Site. Where any Company-Owned Interconnection Facilities are to be located on the Site, Seller shall provide, at no expense to Company, a location and access acceptable to Company for all such Company-Owned Interconnection Facilities, as well as an easement, license or right of entry to access such Company-Owned Interconnection Facilities. If power sources (120/240VAC) are required, Seller shall provide such sources, at no expense to Company.
- (c) IRS. An IRS addressing Facility requirements was completed for the Project in accordance with the IRS Letter Agreement, and the results have been incorporated in Attachment B (Facility Owned by Seller) and this Attachment G (Company-Owned Interconnection Facilities) as appropriate.
- (d) Seller's Payment Obligations. Company-Owned Interconnection Facilities, for which Seller has agreed to pay, whether designed, engineered and constructed by Seller or Company, include **[ADD LIST OF COMPANY-OWNED INTERCONNECTION FACILITIES THAT ARE REQUIRED PURSUANT TO THE RESULTS OF THE IRS. THE FOLLOWING IS AN EXAMPLE OF THE TYPES OF FACILITIES THAT COULD BE LISTED]:**
- (i) **[Line extension];**
- (ii) A manually operated, lockable, group operated switch located on a pole prior to the Facility

- switching station. Company will install a ___ kV drop into Seller-provided deadend structure.
- (iii) Substation additions and/or modifications of Company's existing structures as necessary. This would include but not be limited to protective relaying and setting changes;
 - (iv) Supervisory control and communications equipment (including but not limited to, SCADA/RTU, microwave, satellite, dedicated phone line(s) and/or any other acceptable communications means (determined by Company), fiber optics, copper cabling, installation of batteries and charger system, etc.);
 - (v) Revenue Metering Package as provided in Section 10.1 (Meters) of the Agreement;
 - (vi) Any additional Interconnection Facilities needed to be installed as a result of final determination of Facility switching station site, final design of Facility to enable Company to complete the Interconnection Facilities and be compatible with Good Engineering and Operating Practices.
 - (vii) If equipment that is not standard to Company is utilized, Seller shall, at the discretion of Company, provide adequate spares.
- (e) Revisions to Costs. The list of Company-Owned Interconnection Facilities, and engineering and testing costs for Company-Owned Interconnection Facilities, for which Seller agrees to pay in accordance with this Attachment G (Company-Owned Interconnection Facilities), are subject to revision if (i) before approving this Agreement, the PUC approves a power purchase agreement for another non-Company owned electric generating facility ("Second NUG Contract") to supply electric energy to Company using the same line to which Facility is to be connected or (ii) the line to which Facility is to be connected and/or the related transformer(s) need(s) to be upgraded and/or replaced as a result of this Agreement and a Second NUG Contract, and the PUC, in approving this Agreement, determines that Seller should pay for all or part of the cost of such upgrade and/or replacement.

(f) Review of the Listing and Costs. If the Commercial Operations Date is not achieved within twelve (12) months of the Effective Date or thirty (30) months from the Execution Date, whichever is less, the listing of the Company-Owned Interconnection Facilities required in this Agreement and the cost-estimates for such Company-Owned Interconnection Facilities are subject to review and revision. Such revision may include, but not be limited to, such items as reconductoring an existing transmission or distribution line, construction of a new line, increase transformer capacity, and alternative relay specifications. In addition, such review and revision may require that the Company re-perform or update the IRS at the Seller's expense.

(g) Responsibility of Seller and Company. The general responsibilities of Seller and Company for the design, procurement, installation, programming/testing, and maintenance/ownership of equipment at the Facility and the Company-Owned Interconnection Facilities is specified in Matrix G-1 (Substation Responsibilities) and Matrix G-2 (Telecom Responsibilities). **[DRAFTING NOTE: MATRIXES WILL BE UPDATED FOLLOWING COMPLETION OF IRS.]**

[DRAFTING NOTE: THE TYPICAL TIMEFRAMES ON O'AHU FOR COMPANY TO ENGINEER, PROCURE AND CONSTRUCT THE COMPANY-OWNED INTERCONNECTION FACILITIES, FOLLOWING THE COMPLETION OF: 1) THE IRS; 2) SELLER'S SINGLE LINE

FOLLOWS:

(i) 36 MONTHS FOR 138 kV FACILITIES.

(ii) 30 MONTHS FOR 46 kV FACILITIES WITH MINOR INFRASTRUCTURE IMPROVEMENTS.] [DRAFTING NOTE: FOR OTHER ISLANDS.]

2. Construction and Support Services By Seller.

(a) Construction and Support Services By Seller.

(i) Seller (and/or its Third Party consultants or contractors (collectively, "Contractors")) will design, engineer, construct, test and place in service, at Seller's expense:

- A. The items identified in Matrix G-1 (Substation Responsibilities) and Matrix G-2 (Telecom Responsibilities) as being the responsibility of Seller to construct; and
- B. **[ANY OTHER COMPANY-OWNED INTERCONNECTION FACILITIES TO BE CONSTRUCTED BY SELLER].
[NOTE: SUBPARTS "A" AND "B" BETWEEN THEM SHOULD GENERALLY INCLUDE A SUBSET OF THE LIST IN SECTION 1(d) ABOVE]**

All design, engineering and construction performed by Seller (and/or its Contractors) shall, without limitation, satisfy the wind load and seismic load requirements of the International Building Code and any more stringent requirements imposed under applicable Laws.

- (ii) Seller shall provide the necessary support for the Company's [REDACTED] kV overhead line extension work, which may include, but not limited to:
 - A. Furnish surveyed topographical drawing including contour lines of project areas and beyond as needed in State Plane coordinates with overlay of the Facility and Company pole line route(s) indicating pole locations and anchors in CADD format acceptable to Company.
 - B. Staking of Company proposed poles and anchors by surveyor.
 - C. Graded access roads including gravel if required by Company to provide sufficient vehicle access to Company poles and anchors by Company trucks and cranes.
 - D. Graded level pads to provide vehicle working areas around all Company poles and anchors.
 - E. Grading of the areas beneath the Company's overhead lines as needed to provide required ground clearance.
 - F. Grubbing and clearing of vegetation within Company's easement area or as required.

- (b) Coordination of Construction. Prior to Seller engaging the Contractors, Seller shall obtain Company's written

approval, which approval shall not be unreasonably withheld. Prior to Seller and/or its Contractors first starting to work on the construction plans for Company-Owned Interconnection Facilities to be constructed by Seller (and/or its Contractors), such as the civil, structural, and construction drawings, specifications to vendors, vendor approved final drawings and materials lists (collectively, the "Plans"), Seller and/or its Contractors shall meet with Company to discuss the construction of such Company-Owned Interconnection Facilities, including but not limited to subjects concerning coordination of construction milestone dates, agreement on areas of interface design, and Company's design/drawing layout and symbols standards, equipment specifications and construction specifications and standards. Company will provide the design and specifications information so Seller can incorporate such information in its bid documents.

- (c) Plans. No later than sixty (60) Days before Seller and/or its Contractors first start to order materials and equipment for Company-Owned Interconnection Facilities to be constructed by Seller and/or its Contractors, Seller shall provide Company with the Plans. The Plans for Company-Owned Interconnection Facilities to be constructed by Seller (and/or its Contractors) shall comply with (i) all applicable Laws; (ii) Company's design/drawing layout and symbol standards, equipment specifications, and construction specifications and standards; and (iii) Good Engineering and Operating Practices (collectively, the "Standards").
- (d) Company's Review of the Plans. Unless otherwise agreed to by the Parties, Company shall have thirty (30) Days following receipt of the Plans for it to review and comment on the Plans, and verify in writing to Seller that the Plans comply with the Standards, which verification shall not be unreasonably withheld. If Company reasonably determines that the Plans are not in accordance with the Standards, then it may request in writing a response from Seller to its comments and Seller shall respond in writing within thirty (30) Days of such request by providing (i) its justification for why its Plans conform to the Standards or (ii) changes in the Plans responsive to Company's comments and in accordance with the Standards.

- (e) Company Inspection. Construction work will be subject to Company inspections to ensure that construction is done in accordance with the Standards. Company inspectors will be allowed access to the construction sites for inspections and to monitor construction work. The inspector shall have the authority to work with the appropriate construction supervisor to stop any work that does not meet the Standards. All equipment and materials used in Company-Owned Interconnection Facilities to be constructed by Seller and/or its Contractors shall meet the Standards.
- (f) Acceptance Test Procedures.
- (i) The following conditions precedent must be satisfied prior to the conduct of the Acceptance Test:
- Final Single-Line Drawing, and notes, has received Company's written consent pursuant to Section 1(a)(i) (Single Line Drawing, Interface Block Diagram, Relay List, Relay Settings and Trip Scheme) of Attachment B (Facility Owned by Seller) to this Agreement.
 - Final Relay List and Trip Scheme have received Company's written consent pursuant to Section 1(a)(i) of Attachment B (Facility Owned by Seller) to this Agreement.
 - Final Interface Block Diagram has received Company consent pursuant to Section 1(a)(i) of Attachment B (Facility Owned by Seller) to this Agreement.
 - Final Control **System RTU** Points List has received Company consent. **[DRAFTING NOTE FOR HELCO, REPLACE HIGHLIGHTED TEXT WITH "Telemetry and Control."]**
 - Final **digital fault recorder settings** have received Company consent. **[DRAFTING NOTE FOR HELCO, REPLACE HIGHLIGHTED TEXT WITH "phasor measurement unit (PMU) devices."]**
 - No later than 14 Days prior to commencement of the Acceptance Test:
 - Seller shall have certified to Company that Seller-Owned Interconnection

Facilities have been installed and commissioned and such certification has not, prior to the commencement of the Acceptance Test, been subsequently challenged by Company on the basis of on-site observations made by the Company's representatives following the walk-through to be conducted pursuant to Section 2(f)(ii) of this Attachment G (Company-Owned Interconnection Facilities).

- Seller shall have certified to Company that any Company-Owned Interconnection Facilities built by Seller (and/or its Contractors) have been installed and commissioned and such certification has not, prior to the commencement of the Acceptance Test, been subsequently challenged by Company on the basis of on-site observations made by the Company's representatives following the walk-through to be conducted pursuant to Section 2(f)(ii) of this Attachment G (Company-Owned Interconnection Facilities).
- Any Company-Owned Interconnection Facilities not built by or on behalf of Seller have been installed and commissioned.
- No later than 7 Days prior to the commencement of the Acceptance Test, Seller and Company shall have participated in walk-through of fully constructed Interconnection Facilities.
- Redlined as-built drawings of the Seller-Owned Interconnection Facilities and any of the Company-Owned Interconnection Facilities built by Seller (and/or its Contractors) shall have been provided to Company.
- Continuous power is being supplied to Company's protection and SCADA equipment.
- Not less than four (4) weeks prior to the commencement of the Acceptance Test, the high speed communication lines required under this Agreement have been commissioned and are ready for use.

- Not less than two (2) weeks prior to the commencement of the Acceptance Test, Seller and Company have participated in an on-Site Acceptance Test coordination meeting.
- (ii) Seller shall provide Company with at least fourteen (14) Days advance written notice of the commencement of the Acceptance Test. The Acceptance Test will be conducted on Business Days during normal business hours and may take a minimum of 30 Days to complete. No electric energy will be delivered from Seller to Company during the Acceptance Test. No later than thirty (30) Days prior to conducting the Acceptance Test, Company and Seller shall agree on a written protocol setting out the detailed procedure and criteria for passing the Acceptance Test. Attachment N (Acceptance Test General Criteria) provides general criteria to be included in the written protocol for the Acceptance Test. At the time that Seller provides its 14-Day notice of the Acceptance Test to Company, Seller shall concurrently schedule a site walk-through of the Facility with Company to occur no later than seven (7) Days prior to the Acceptance Test. Seller's 14-Day notice to Company of the Acceptance Test shall constitute its certification that (i) the completion of the installation and commissioning of the Seller-Owned Interconnection Facilities and the Company-Owned Interconnection Facilities built by Seller (and/or its Contractors) and (ii) a walk-through by Company shall demonstrate, to Company's reasonable satisfaction, Seller's readiness to commence with the Acceptance Test. If, after the site walk-through, Company representatives reasonably determine that Seller is not ready to commence with the Acceptance Test, Seller shall remediate the deficiencies identified by Company and, upon completion, re-submit its 14-Day written notice of the Acceptance Test, and the process described in this Section 1(f) (Acceptance Test Procedures), shall commence again until Seller's readiness for the Acceptance Test is demonstrated to Company's reasonable satisfaction. Successful completion of the Acceptance Test requires successful completion of each of the individual tests that comprise the

Acceptance Test. Retesting of any individual test constitutes as restart of the Acceptance Test if such retesting is required because of a prior failure of such individual test or because of a prior test could not be completed because of a problem with the Facility. Within fifteen (15) Business Days of completion of the Acceptance Test and Company's receipt of the final report setting forth the results of the Acceptance Test, Company shall notify Seller in writing whether the Acceptance Test has been passed and, if so, the date upon which the Acceptance Test was passed.

(iii) Company will be present when the Acceptance Test is conducted, and Seller shall promptly correct any deficiencies identified during the Acceptance Test. Seller will be responsible for the cost of Company personnel (and/or Company contractors) performing the duties (such as reviewing the Plans and reviewing the construction) necessary for Company-Owned Interconnection Facilities to be constructed by Seller (and/or its Contractors). If Company (i) does not make any inspection or test, (ii) does not discover defective workmanship, materials or equipment, or (iii) accepts Company-Owned Interconnection Facilities (that were constructed by Seller and or its Contractors), such action or inaction shall not relieve Seller from its obligation to do and complete the work in accordance with the Plans approved by Company.

(g) As-Built Drawings. Within thirty (30) Days of the successful completion of the Acceptance Test, Seller shall provide for Company review a set of the proposed as-built drawings for the Company-Owned Interconnection Facilities constructed by Seller (and/or its Contractors). Within thirty (30) Days of Company's receipt of the proposed as-built drawings, Company shall provide Seller with either (i) its comments on the proposed as-built drawings or (ii) notice of acceptance of the proposed as-built drawings as final as-built drawings. If Company provides comments on the proposed as-built drawings, Seller shall incorporate such comments into a final set of as-built drawings and provide such

final as-built drawings to Company within twenty (20)
Days of Seller's receipt of Company's comments

3. Seller Payment To Company for Company-Owned Interconnection
Facilities and Review Of Facility.

(a) Seller Payment to Company.

(i) Seller shall pay the Total Estimated Interconnection Cost which is comprised of the estimated costs of (aa) acquiring, constructing and installing the Company-Owned Interconnection Facilities to be designed, engineered and constructed by Company, (bb) the engineering and design work (including but not limited to Company, affiliated Company and contracted engineering and design work) associated with (i) the application process for the PUC Approval Order, (ii) developing such Company-Owned Interconnection Facilities and (iii) reviewing and specifying those portions of Facility which allow interconnected operations as such are described in Attachment B(Facility Owned by Seller) (collectively, the "Engineering and Design Work"), and (cc) conducting the Acceptance Test and Control System Acceptance Test. The Total Actual Interconnection Cost (the actual cost of items (aa) through (cc)) are the "Total Interconnection Cost".

(ii) Summary List of Company-Owned Interconnection Facilities and Related Services to be designed, engineered and constructed by Company:

[THIS LIST SHOULD GENERALLY INCORPORATE A SUBSET OF THE LIST IN ATTACHMENT G, SECTION 1(d), PLUS TESTING.]

(i) The following summarizes the Total Estimated Interconnection Cost of the Company-Owned Interconnection Facilities to be designed, engineered and constructed by Company:

[THIS LIST SHOULD INCLUDE ESTIMATED COSTS FOR THE ITEMS LISTED IN ATTACHMENT G, SECTION 3(a)(ii).]

The Total Estimated Interconnection Cost is \$.

- (b) Total Estimated Interconnection Costs. The Total Estimated Interconnection Cost, which, except as otherwise provided herein, is non-refundable, shall be paid in accordance with the following schedule:
- (i) Initial Payment: Prior to the Execution Date, Seller has paid \$ [REDACTED],000.00 to Company;
 - (ii) Company-Owned Interconnection Facilities Prepayment: Thirty (30) Days after the Execution Date, the total estimated costs related to the Engineering and Design Work are due and payable by Seller to Company;
 - A. Company shall not be obligated to perform any Engineering and Design Work or procure and construct Company-Owned Interconnection Facilities until Seller pays the amounts in Section 3(b)(i) and Section 3(b)(ii) of this Attachment G (Company-Owned Interconnection Facilities), and receipt of such payment shall constitute Seller's irrevocable authorization to Company to perform such engineering and design work.
 - (iii) Balance of Company-owned Interconnection Facilities Prepayment: Upon the earlier of (aa) 30 Days after the Effective Date or (bb) [**INSERT CALENDAR DATE BY WHICH EQUIPMENT MUST BE ORDERED TO MEET CONSTRUCTION SCHEDULE**], the difference between the portion of the Total Estimated Interconnection Cost paid to date and the Total Estimated Interconnection Cost is due and payable by Seller to Company.
 - A. Company shall not be obligated to perform any Engineering and Design Work or procure and construct Company-Owned Interconnection Facilities until Seller pays the amount in this Section 3(b)(iii) of this Attachment G (Company-Owned Interconnection Facilities), and receipt of such payment shall constitute Seller's irrevocable authorization to Company to perform such procurement and construction work.
- (c) True-Up. The final accounting shall take place within one hundred twenty (120) Days of the first to occur of

(i) the Commercial Operations Date, (ii) the date this Agreement is declared null and void under either Section 12.5 (Prior to Effective Date) or Section 12.6 (Time Periods for PUC Submittal Date and PUC Approval), or (iii) the date this Agreement is terminated, whichever occurs first. Company shall be entitled to an extension for a commercially reasonable amount of time to complete the final accounting if a delay in such completion is caused by Seller's delay or failure to respond to any Company request for information needed to complete the final accounting or take any action necessary for Company to complete the final accounting. Upon completion of the final accounting, Company shall deliver to Seller an invoice for payment of the amount, if any, of the difference between the Total Estimated Interconnection Cost paid to date and the Total Actual Interconnection Cost, which is the final accounting of the Total Interconnection Costs. Payment of such invoice shall be made within thirty (30) Days of receipt of such invoice from Company. If the Total Actual Interconnection Cost is less than the payments received by Company as the Total Estimated Interconnection Cost, Company shall repay the difference to Seller within thirty (30) Days of the final accounting.

(d) Audit Rights. Seller shall have the right for a period of one (1) year following receipt of the invoice: (i) upon reasonable prior notice, to audit the books and records of Company to the limited extent reasonably necessary to verify the basis for the amount (if any) by which the Total Actual Interconnection Cost invoiced to Seller exceeds the Total Estimated Interconnection Cost, and (ii) to dispute the amount of any such excess. Seller shall not have the right to audit any other financial records of Company. Company shall make such information available during normal business hours at its offices in Hawai'i. Seller shall pay Company's reasonable actual, verifiable costs for such audits, including allocated overhead.

(e) Ownership. All Company-Owned Interconnection Facilities including those portions, if any, provided, or provided and constructed, by Seller shall be the property of Company.

4. Ongoing Operation and Maintenance Charges.

- (a) Prior to the Transfer Date. Seller shall operate and maintain, at its sole cost and expense, Company-Owned Interconnection Facilities that it or its Contractors constructed, if any, prior to the Transfer Date.
 - (b) On or After the Transfer Date. On and after the Transfer Date, Company shall own, operate and maintain Company-Owned Interconnection Facilities.
 - (c) Monthly Bill. Company shall bill Seller monthly for any costs incurred in operating, maintaining and replacing (to the extent not covered by insurance) Company-Owned Interconnection Facilities. Company's costs will be determined on the basis of, but not limited to, direct payroll, material costs, applicable overhead at the time incurred, consulting fees and applicable taxes. Seller shall, within thirty (30) Days after the billing date, reimburse Company for such monthly billed operation and maintenance charges.
5. Relocation of Company-Owned Interconnection Facilities.
- (a) In the event that the Land Rights include a relocation clause and such clause is exercised or if Company-Owned Interconnection Facilities must be relocated for any other reason not caused by Company, Seller shall bear the cost of such relocation. Prior to the relocation of the Company-Owned Interconnection Facilities Company shall invoice Seller for the total estimated cost of relocating the Company-Owned Interconnection Facilities (the "Total Estimated Relocation Cost"). Seller shall, within thirty (30) Days after the invoice date, pay to Company the Total Estimated Relocation Cost.
 - (b) Once the relocation of the Company-Owned Interconnection Facilities is complete, Company shall conduct a final accounting of all costs related thereto. Within thirty (30) Days of the final accounting, which shall take place within one hundred and twenty (120) Days of completion of the relocation of Company-Owned Interconnection Facilities, Seller shall remit to Company the difference between the Estimated Relocation Cost paid to date and the total actual relocation cost incurred by Company (the "Total Actual Relocation Cost"). If the Total Actual Relocation Cost is less than the payments received by Company as the Total Estimated Relocation Cost, Company shall repay the

difference to Seller within thirty (30) Days of the final accounting.

6. Guarantee for Interconnection Costs.

- (a) Standby Letter of Credit. To ensure payment by Seller of all costs and expenses incurred by Company (i) in excess of the Total Estimated Interconnection Cost paid in connection with the Company-Owned Interconnection Facilities to be provided and/or constructed by Company described in Section 3 (Seller Payment to Company for Company-Owned Interconnection Facilities and Review of Facility) of this Attachment G (Company-Owned Interconnection Facilities), and (ii) if applicable, in excess of the Total Estimated Relocation Costs paid in connection with the relocation of the Company-Owned Interconnection Facilities as provided in Section 5 (Relocation of Company-Owned Interconnection Facilities), Seller shall obtain an Irrevocable Standby Letter of Credit with no Documentary Requirement ("Standby Letter of Credit") in accordance with the requirements of Section 6(b) (Requirements of the Standby Letter of Credit) of this Attachment G (Company-Owned Interconnection Facilities), wherein Company shall receive payment from the bank upon request by Company.
- (b) Requirements of the Standby Letter of Credit. The Standby Letter of Credit shall be (i) in an amount not less than twenty-five percent (25%) of the Total Estimated Interconnection Cost or Total Estimated Relocation Cost, as applicable, and (ii) in substantially in the form attached to this Agreement as Attachment M (Form of Letter of Credit) from a bank or other financial institution located in the United States with a credit rating of "A-" or better. If the rating (as measured by Standard & Poors) of the bank or financial institution issuing the Standby Letter of Credit falls below A-, Company may require Seller to replace the Standby Letter of Credit with a Standby Letter of Credit from another bank or financial institution located in the United States with a credit rating of "A-" or better. In connection with the construction of the Company-Owned Interconnection Facilities, the Standby Letter of Credit shall be effective from the earlier of (aa) thirty (30) Days following the Effective Date, or (bb) the date that Seller requests Company to order equipment or commence construction on Company-Owned Interconnection

Facilities. In connection with the relocation of the Company-Owned Interconnection Facilities, if applicable, the Standby Letter of Credit shall be effective within thirty (30) Days after Seller receives the invoice from Company for the Total Estimated Relocation Cost as set forth in Section 5 (Relocation of Company-Owned Interconnection Facilities) of this Attachment G (Company-Owned Interconnection Facilities). The Standby Letter of Credit shall be in effect through the earlier of forty-five (45) Days after the final accounting or seventy-five (75) Days after the Agreement is terminated. Seller shall provide to Company within fourteen (14) Days of the date the Standby Letter of Credit is to be effective as aforesaid, a document from the bank which indicates that such a Standby Letter of Credit has been established.

- (c) Other Form of Security. Notwithstanding the foregoing, in lieu of a Standby Letter of Credit, Company may, at its sole discretion, agree in writing to accept such other form of security as Company deems to provide Company with protection equivalent to a Standby Letter of Credit.

7. Land Restoration.

- (a) Definition of "Land". For the purposes of this Attachment G (Company-Owned Interconnection Facilities), "Land" means any portion of the Site and any other real property where any Company-Owned Interconnection Facilities are located.
- (b) Removal of Interconnection Facilities. After termination of this Agreement or in the event this Agreement is declared null and void under either Section 12.5 (Prior to Effective Date) or Section 12.6 (Time Periods for PUC Submittal Date and PUC Approval), if requested by Company, Seller shall, at its sole cost and expense, remove (i) the Company-Owned Interconnection Facilities from the Land and (ii) the Seller-Owned Interconnection Facilities from the Land, and, in conjunction with such removal, shall develop and implement a program to recycle, to the fullest extent possible, or to otherwise dispose of, all such removed infrastructure; provided, however, that, Company may elect to remove all or part of the Company-Owned Interconnection Facilities and/or Seller-Owned Interconnection Facilities from the Land because of operational concerns over the removal of such

Interconnection Facilities, in which case Seller shall reimburse Company for its costs to remove such Company-Owned Interconnection Facilities and/or Seller-Owned Interconnection Facilities. To the extent Seller is obligated to remove Company-Owned Interconnection Facilities and/or Seller-Owned Interconnection Facilities, Seller shall complete such removal within ninety (90) Days of termination of this Agreement (or declaration that the Agreement is null and void under either Section 12.5 (Prior to Effective Date) or Section 12.6 (Time Periods for PUC Submittal Date and PUC Approval), or as otherwise agreed to by both Parties in writing.

- (c) Restoration of the Land. After the termination of this Agreement (or declaration that the Agreement is null and void under either Section 12.5 (Prior to Effective Date) or Section 12.6 (Time Periods for PUC Submittal Date and PUC Approval)) and removal of the Company-Owned Interconnection Facilities and/or Seller-Owned Interconnection Facilities, as the case may be, Seller shall, at its sole cost and expense, restore the Land to its condition prior to construction of such Company-Owned Interconnection Facilities and/or Seller-Owned Interconnection Facilities, as applicable. Land restoration shall be completed within ninety (90) Days of termination of this Agreement (or declaration that the Agreement is null and void under either Section 12.5 (Prior to Effective Date) or Section 12.6 (Time Periods for PUC Submittal Date and PUC Approval)), or as otherwise agreed to by both Parties in writing.

8. Transfer of Ownership/Title.

- (a) Transfer of Ownership and Title. On the Transfer Date, Seller shall transfer to Company all right, title and interest in and to Company-Owned Interconnection Facilities to the extent such facilities were designed and constructed by Seller and/or its Contractors together with (i) all applicable manufacturers' or Contractors' warranties which are assignable and (ii) all Land Rights necessary to operate and maintain Company-Owned Interconnection Facilities on and after the Transfer Date. Seller shall provide a written list of the manufacturers' and Contractors' warranties which will be assigned to Company and the expiration dates of such warranties no later than thirty (30) Days before the Transfer Date.

- (b) No Liens or Encumbrances. Company's title to and ownership of Company-Owned Interconnection Facilities that were designed and constructed by Seller and/or its Contractors shall be free and clear of liens and encumbrances.
- (c) Form of Documents. The transfers to be made to Company pursuant to this Section 8 (Transfer of Ownership/Title) of Attachment G (Company-Owned Interconnection Facilities) shall not require any further payment by Company. The form of the document to be used to convey title to the Company-Owned Interconnection Facilities that were designed and constructed by or on behalf of Seller shall be substantially in the form set forth in Attachment H (Form of Bill of Sale and Assignment). The form of the document(s) to be used to assign leases shall be substantially in the form set forth in Attachment I (Form of Assignment of Lease and Assumption). To the extent Land Rights other than leases are transferred to Company, appropriate modifications will be made to Attachment I (Form of Assignment of Lease and Assumption) to effectuate the transfer of such Land Rights.

9. Governmental Approvals for Any Company-Owned Interconnection Facilities Constructed by Seller.

Seller shall obtain at its sole cost and expense all Governmental Approvals necessary to the construction, ownership, operation and maintenance of the Company-Owned Interconnection Facilities. For Company-Owned Interconnection Facilities to be constructed by Company, Seller shall provide all Governmental Approvals necessary to the construction of such Company-Owned Interconnection Facilities prior to the commencement of construction by Company. For all other Governmental Approvals for Company-Owned Interconnection Facilities, Seller shall provide these prior to the Transfer Date. On or before the Transfer Date, Seller shall provide Company with (i) copies of all such Governmental Approvals obtained by Seller regarding the construction, ownership, operation and maintenance of Company-Owned Interconnection Facilities that Seller and/or its Contractors constructed and (ii) documentation regarding the satisfaction of any condition or requirement set forth in any Governmental Approvals for Company-Owned Interconnection Facilities or that such Governmental Approvals have otherwise have been closed with the issuing Governmental Authority.

10. Land Rights.

Seller shall obtain at its sole cost and expense all Land Rights that are required to construct, own, operate and maintain the Company-Owned Interconnection Facilities. Without limitation to the preceding sentence, Seller shall pay all surveying and mapping costs, appraisal fees, document preparation fees, recording fees or other costs. Seller shall use commercially reasonable efforts to obtain on behalf of the Company perpetual Land Rights for the Company-Owned Interconnection Facilities. Such Land Rights shall contain terms and conditions which are acceptable to Company and the documents setting forth the Land Rights shall be provided in advance of execution to Company for its review and approval and shall be recorded if required by Company. Following the Execution Date, Seller shall provide as part of the Monthly Progress Report the status of negotiations with landowner(s) regarding the Land Rights. Notwithstanding the foregoing, Company shall have the right in its sole discretion, at any time upon notice to Seller, to communicate directly with the landowner(s) and/or participate in the negotiations with landowner(s) for the Land Rights. For so long as Seller has the right under this Agreement to sell electric energy to Company, Seller shall pay for any rents and other payments due under such Land Rights that are associated with Company-Owned Interconnection Facilities.

11. Contracts for Company-Owned Interconnection Facilities.

For all contracts entered into by or on behalf of Seller for Company-Owned Interconnection Facilities to be designed, engineered and constructed, in whole or in part, by or on behalf of Seller, the following shall apply: (i) Company shall be made an intended third-party beneficiary of such contracts; and (ii) Company shall be provided with copies of such executed contracts, including the commercial terms.

[MATRIX TO BE INSERTED]

ATTACHMENT H
BILL OF SALE AND ASSIGNMENT

THIS BILL OF SALE AND ASSIGNMENT ("Bill of Sale"), made as of the ____ day of _____, 20____, by _____ ("Transferor") and _____ ("Transferee").

W I T N E S S E T H:

1. Bill of Sale. In consideration of the mutual covenants and agreements of Transferor and Transferee under the Power Purchase Agreement for Renewable Dispatchable Generation between Transferor and Transferee dated _____, 20__ ("PPA") and other good and valuable consideration, the receipt and sufficiency of which are hereby acknowledged, Transferor does hereby sell, assign and transfer over to Transferee all of Transferor's right, title and interest, in and to (i) all the tangible personal property and fixtures (including but not limited to the items set forth in Schedule H-1 (Description of Tangible Personal Property and Fixtures) attached hereto and incorporated herein), that constitutes what is referred to as the "Company-Owned Interconnection Facilities to be installed by or on behalf of Seller" (or words to similar effect) as set forth in Attachment G (Company-Owned Interconnection Facilities) to the PPA between [**Transferor and Transferee**] and (ii) the intangible personal property (including but not limited to the intangible personal property set forth in Schedule H-2 (Description of Intangible Personal Property) attached hereto and incorporated herein) owned by Transferor and used or to be used in the ownership, operation and maintenance of the aforesaid tangible personal property, to the extent assignable by Transferor, including without limitation, certificates of occupancy, permits, licenses, transferable warranties and guaranties, instruments, documents of title, and general intangibles pertaining to the aforesaid intangible personal property.

2. Warranty of Title. Transferor hereby warrants to Transferee that Transferor is the legal owner of the aforesaid tangible personal property and the aforesaid intangible personal property (including but not limited to the property set forth in Schedule H-1 (Description of Tangible Personal Property and Fixtures) and Schedule H-2 (Description of Intangible Personal Property)), and that said property is being sold, assigned and transferred to Transferee free and clear of all liens and encumbrances.

3. Governing Law. This Bill of Sale shall be governed by, and construed and interpreted in accordance with, the laws of the State of Hawai'i.

**[Signatures for Bill of Sale and Assignment
Appear on the Following Page]**

IN WITNESS WHEREOF, Transferor and Transferee have executed this instrument on the day and year first above written.

_____,
a _____

By _____
Its _____

"Transferor"

_____,
a Hawai'i corporation

By _____
Its _____

By _____
Its _____

"Transferee"

SCHEDULE H-1

**DESCRIPTION OF
TANGIBLE PERSONAL PROPERTY AND FIXTURES**

SCHEDULE H-2

DESCRIPTION OF INTANGIBLE PERSONAL PROPERTY

LAND COURT SYSTEM

REGULAR SYSTEM

Return by Mail () Pickup () To:

Tax Map Key Nos.:

Total pages: _____

ATTACHMENT I
ASSIGNMENT OF LEASE AND ASSUMPTION

THIS ASSIGNMENT is made as of this _____ day of _____, 20____, by _____, a _____, whose principal place of business and post office address is _____, hereinafter called the "Assignor," and _____, a Hawai'i corporation, whose principal place of business and post office address is _____, Honolulu, HI 968____, hereinafter called the "Assignee",

W I T N E S S E T H:

THAT the Assignor, for and in consideration of the sum of TEN DOLLARS (\$10.00) and other good and valuable consideration to it paid by the Assignee, the receipt and sufficiency of which are hereby acknowledged, and of the covenants and agreements of the Assignee hereinafter contained and on the part of the Assignee to be faithfully kept and performed, does hereby sell, assign, delegate, transfer, set over and deliver unto the Assignee, and its successors and assigns, all of Assignor's right, title and interest in and to the lease described in Schedule 1 (the "Lease"); together with

all interests thereto appertaining, and together with the personal property located on the land thereby demised.

And all of the estate, right, title and interest of the Assignor in and to the land thereby demised, and all buildings, improvements, rights, easements, privileges and appurtenances thereunto belonging or appertaining or used, occupied and enjoyed in connection with said Lease and the land thereby demised.

TO HAVE AND TO HOLD the same unto Assignee and its successors and assigns, for and during the respective unexpired term of said Lease, and as to said personal property (if any) absolutely and forever.

AND, in consideration of the premises, the Assignor does hereby covenant with the Assignee that the Assignor is the lawful owner of the herein described real property; that said Lease is in full force and effect and is not in default; that said real property is free and clear of and from all liens and encumbrances, except for the lien of real property taxes not yet by law required to be paid; that the Assignor is the lawful owner of said personal property (if any) and that Assignor's title thereto is free and clear of and from all liens and encumbrances, that the Assignor has good right to sell and assign said real property and personal property (if any) as aforesaid; and, that the Assignor will WARRANT AND DEFEND the same unto the Assignee against the lawful claims and demands of all persons, except as aforesaid.

AND, in consideration of the foregoing, the Assignee does hereby promise, covenant and agree to and with the Assignor and to and with said Lessor, that the Assignee will, effective as of and from the date of the execution and delivery of this instrument and during the residue of the term of said Lease, pay the rents thereby reserved as and when the same become due and payable pursuant to the provisions of said Lease, and will also faithfully observe and perform all of the covenants and conditions contained in said Lease which from and after the date hereof are or ought to be observed and performed by the lessee therein named, and will at all times hereafter indemnify and save harmless the Assignor from and against the nonpayment of said rent and the nonobservance or nonperformance of said covenants and conditions and each of them.

The terms "Assignor" and "Assignee", as and when used herein, or any pronouns used in place thereof, shall mean and

include the masculine, feminine or neuter, the singular or plural number, individuals, partnerships, trustees or corporations and their and each of their respective successors, heirs, personal representatives, successors in trust and assigns, according to the context hereof. All covenants and obligations undertaken by two or more persons shall be deemed to be joint and several unless a contrary intention is clearly expressed elsewhere herein. The term "Lease", as and when used herein, means the lease or sublease demising the leasehold estate described in Schedule 1, together with all recorded amendments thereof, if any, whether or not listed in Schedule 1. The term "rent", as and when used herein, means and includes all rents, taxes, assessments and any other sums charged pursuant to the Lease.

This instrument may be executed in any number of counterparts, each of which shall be deemed an original, but all of which shall constitute one instrument binding on all the Parties hereto, notwithstanding that all the Parties are not signatory to the original or the same counterpart.

[Signatures for Assignment of Lease and Assumption are on following page.]

IN WITNESS WHEREOF, Company and Assignor have executed
this instrument as of the date first above written.

By _____
Name:
Title:

By _____
Name:
Title:

"Assignor"

By _____
Name:
Title:

By _____
Name:
Title:

"Assignee"

STATE OF HAWAI'I)
) SS:
CITY AND COUNTY OF HONOLULU)

On this ____ day of _____, 200__, before me personally appeared _____ and _____, to me known to be the persons described in and who executed the foregoing instrument, and acknowledged that such persons executed such instrument as the free act and deed of such persons and if applicable in the capacity shown, having been duly authorized to execute such instrument in such capacity.

(Official Stamp or Seal)

Signature: _____
Print Name: _____
Notary Public, State of Hawai'i

My commission expires: _____

NOTARY CERTIFICATION STATEMENT

Document Identification or
Description: _____

Doc. Date _____ No. of Pages: ____

Jurisdiction: _____ Circuit
(in which notarial act is performed)

(Official Stamp or Seal)

Signature of Notary _____ Date of Notarization and
Certification Statement

Printed Name of Notary _____

STATE OF HAWAI'I)
) SS:
CITY AND COUNTY OF HONOLULU)

On this ____ day of _____, 200__, before me personally appeared _____ and _____, to me known to be the persons described in and who executed the foregoing instrument, and acknowledged that such persons executed such instrument as the free act and deed of such persons and if applicable in the capacity shown, having been duly authorized to execute such instrument in such capacity.

(Official Stamp or Seal) Signature: _____
Print Name: _____
Notary Public, State of Hawai'i

My commission expires: _____

NOTARY CERTIFICATION STATEMENT

Document Identification or
Description: _____

Doc. Date _____ No. of Pages: ____
Jurisdiction: _____ Circuit
(in which notarial act is performed)

Signature of Notary Date of Notarization and
Certification Statement (Official Stamp or Seal)

Printed Name of Notary

SCHEDULE 1

- Description of Lease
- To Be Attached

ATTACHMENT J
COMPANY PAYMENTS FOR ENERGY AND DISPATCHABILITY

1. Price for Purchase of Electric Energy. Commencing on the Commercial Operations Date, Company shall pay Seller for electric energy delivered to the Point of Interconnection in response to Company Dispatch in accordance with this Agreement at the rate of \$[]/kWh.
2. Lump Sum Payment for Purchase of Dispatchability. Commencing on the Commercial Operations Date, Company shall pay Seller for the availability of the Facility's Net Energy Potential, subject to the Renewable Resource Variability, to respond to Company Dispatch in accordance with this Agreement, a monthly Lump Sum Payment as calculated and adjusted as set forth in Section 3 (Calculation of Lump Sum Payment) of this Attachment J (Company Payments for Energy and Dispatchability). The monthly Lump Sum Payment shall be calculated and adjusted to reflect changes in the estimate of the Facility's Net Energy Potential as such estimate is revised from time to time as more fully set forth in Attachment U (Calculation and Adjustment of Net Energy Potential) to this Agreement.
3. Calculation of Lump Sum Payment. The monthly Lump Sum Payment shall be calculated and adjusted as follows:
 - i. Lump Sum Payment During First Benchmark Period. During the First Benchmark Period, the monthly Lump Sum Payment shall be equal to one-twelfth (1/12th) of the product (rounded to the nearest cent) obtained by multiplying the Unit Price by the First NEP Benchmark.
 - ii. Lump Sum Payment During Second Benchmark Period.
 - a. One purpose of the Second Benchmark Period is to provide the Seller, in the event that the Initial NEP OEPR Estimate is less than NEP RFP Projection, with a limited period during which Seller will have an opportunity, by having a Subsequent OEPR prepared pursuant to Section 3(b) (Voluntary Subsequent OEPR) of Attachment U (Calculation Adjustment of Net Energy Potential) to this Agreement, to obtain an adjustment to the NEP OEPR Estimate used to calculate the Lump Sum Payment,

subject to (i) the cap on any upward adjustment imposed by the limitation that the estimate of Net Energy Potential that is used to calculate the Lump Sum Payment shall not exceed the NEP RFP Projection and (ii) the risk that any Subsequent OEPR might result in a downward adjustment to the NEP OEPR Estimate used to calculate the Lump Sum Payment. Accordingly, for each calendar month during the Second Benchmark Period, the monthly Lump Sum Payment shall be equal to one-twelfth (1/12th) of the product (rounded to the nearest cent) obtained by multiplying the Unit Price by the lesser of the (w) the NEP RFP Projection or (x) the NEP OEPR Estimate of the OEPR that is most recent as of the first day of such calendar month. For avoidance of doubt:

1. On the first Day of the Second Benchmark Period, the most recent OEPR will be the Initial OEPR;
2. If no Subsequent OEPR is issued under Section 3 (Subsequent OEPRs) of Attachment U (Calculation and Adjustment of Net Energy Potential) to this Agreement for an OEPR Period of Record ending prior to the end of the fifth (5th) Contract Year, the "most recent OEPR" during the entirety of the Second Benchmark Period will be the Initial OEPR;
3. If any Subsequent OEPR is prepared for an OEPR Period of Record ending prior to the commencement of the sixth (6th) Contract Year, the monthly Lump Sum Payment shall, for the period commencing on the first Day of the calendar month following the month during which an OEPR Evaluator issues such Subsequent OEPR, be equal to one-twelfth (1/12th) of the product (rounded to the nearest cent) obtained by multiplying the Unit Price by the lesser of (w) the NEP OEPR Estimate obtained from such Subsequent

OEPR or (x) the NEP RFP Projection. The monthly Lump Sum Payment calculated as aforesaid shall remain in effect through the first to occur of (y) the end of the Term or (z) the end of the calendar month during which an OEPR Evaluator issues the next Subsequent OEPR (if any) that is required or permitted under Section 4 (Subsequent OPERs) of Attachment U (Calculation and Adjustment of Net Energy Potential) to this Agreement.

iii. Lump Sum Payment Following Second Benchmark Period.

- a. As of the first Day of the sixth (6th) Contract Year, the estimate of Net Energy Potential that was used to calculate the Lump Sum Payment for the last calendar month of the Second Benchmark Period shall continue in effect as the estimate of Net Energy Potential that is used to calculate the Lump Sum Payment until the end of the calendar month during which an OEPR Evaluator issues the first Subsequent OEPR for an OEPR Period of Record ending on or after the commencement of the sixth (6th) Contract Year and, effective at the end of such calendar month, the Second NEP Benchmark that was in effect immediately prior to the issuance of such Subsequent OEPR shall constitute the "Most Recent Prior NEP Benchmark" under clause (i) of the definition of that term set forth in this Agreement. For avoidance of doubt, if no Subsequent OEPR is issued for an OEPR Period of Record ending on or after the commencement of the sixth (6th) Contract Year, the Second NEP Benchmark that was used to calculate the Lump Sum Payment for the last calendar month of the Second Benchmark Period shall continue in effect for the balance of the Term as the estimate of Net Energy Potential that is used to calculate the Lump Sum Payment.

- b. In order to facilitate planning for the Company System, no increase in Net Energy Potential (and hence in the monthly Lump Sum Payment) shall be permitted under this Agreement as a consequence of any Subsequent OEPR that is prepared for an OEPR Period of Record ending on or after the expiration of the Second Benchmark Period. Accordingly, if any such Subsequent OEPR is prepared, the monthly Lump Payment shall, for the period commencing on the first Day of the calendar month following the month during which an OEPR Evaluator issues such Subsequent OEPR, be equal to one-twelfth ($1/12^{\text{th}}$) of the product (rounded to the nearest cent) obtained by multiplying the Unit Price by the lesser of (w) the NEP OEPR Estimate obtained from such Subsequent OEPR or (x) the Most Recent Prior NEP Benchmark. The monthly Lump Sum Payment calculated as aforesaid shall remain in effect through the first to occur of (y) the end of the Term or (z) the end of the calendar month during which an OEPR Evaluator issues the next following Subsequent OEPR (if any) that is required or permitted under Section 3 (Subsequent OEPRs) of Attachment U (Calculation and Adjustment of Net Energy Potential) to this Agreement. If any such next following Subsequent OEPR is issued, the monthly Lump Sum Payment shall, for the period commencing on the first Day of the calendar month following the calendar month during which an OEPR Evaluator issues such Subsequent OEPR, be re-calculated and adjusted as provided in this Section 3.iii.b of this Attachment J (Company Payments for Energy and Dispatchability) and shall continue in effect for the period provided in the preceding sentence.
- iv. Under the Company's previous forms of as-available power purchase agreements for renewable energy, the independent power producer was compensated for the production and delivery of electrical energy and assumed the risk of non-payment for events (such as Force Majeure that prevented such production and delivery. Although under this

Agreement most of Seller's compensation will be in the form of a Lump Sum Payment rather than for the production and delivery of electrical energy, it is not the intent of the Parties that Seller should be entitled to unrestricted compensation in circumstances in which an independent power producer would not have been able to earn compensation under the Company's prior form of power purchase agreements (i.e., if the Facility or any portion thereof is unable to produce and deliver electric energy). Although the liquidated damages that are payable if the Facility PBAF fails to achieve the PBAF Benchmark addresses this issue when a WTGS is unable to generate electric energy because it is in Non-Operative Status under the Modified Information Model, the Facility PBAF does not account for events of Force Majeure because such events are excluded from the calculation of Facility PBAF. Accordingly, and without limitation to the generality of the foregoing provisions of this Section 3 (Calculation of Lump Sum Payment) of this Attachment J (Company Payments for Energy and Dispatchability), the monthly Lump Sum Payment shall be adjusted downward pro rata for each Day or portion thereof during the calendar month in question that one or more WTGS(s) were not available to respond to Company Dispatch because of a Force Majeure condition (i) affecting the Facility or any portion thereof (ii) that otherwise delays or prevents the Seller from making the WTGS(s) in question available for Company Dispatch. For example, if a Facility has ten WTGS(s) and, during the month of May (which has 31 calendar days), one WTGS is not available to respond to Company Dispatch for a period of 15 Days due to a Force Majeure condition as aforesaid, the monetary amount of the resulting downward adjustment to the monthly Lump Sum Payment for the month of May would be calculated as follows:

$$\text{Monetary Amount of Downward Adjustment} = (\text{MLSP} \times 1/10) \times 15/31$$

where:

MLSP = The monthly Lump Sum Payment that would be payable but for the downward adjustment.

For purposes of determining the monetary amount of the foregoing downward adjustment, the product obtained by multiplying a monetary value by a fraction shall be rounded to the nearest cent.

4. Test Energy. Company shall use reasonable efforts to accept test energy that is delivered as part of the normal testing for generators (such as energy delivered to Company during the Control System Acceptance Test but not during the Acceptance Test), provided Seller shall use reasonable efforts to coordinate such normal testing with Company so as to minimize adverse impacts on the Company System and operations. Company shall not compensate Seller for test energy.
5. Tax Credits. Company acknowledges and agrees that the Refundable Tax Credit and Non-Refundable Tax Credit shall inure to the benefit of the Claiming Entity; provided, however, that Seller acknowledges and expressly agrees that the Refundable Tax Credit and Non-Refundable Tax Credit, with regard to Seller's Facility, have been calculated into the Contract Pricing based on the maximization of such credits. In the event that Seller's Facility does not gain the benefit of the Refundable Tax Credit and/or the Non-Refundable Tax Credit, Seller expressly acknowledges and agrees that it shall not seek to amend the Contract Pricing.

**[ATTACHMENT K WILL BE REVISED TO REFLECT
THE RESULTS OF IRS]**

ATTACHMENT K
GUARANTEED PROJECT MILESTONES

Guaranteed Project Milestone Date	Description of Each Guaranteed Project Milestone
The earlier of (i) date that is 30 Days following the Effective Date or (ii) [INSERT DATE BY WHICH EQUIPMENT MUST BE ORDERED TO MEET CONSTRUCTION SCHEDULE] ("Guaranteed Procurement Payment Date")	<u>Procurement Payment Milestone</u> : Seller shall make payment to Company of amount required under <u>Section 3(b)(iii)</u> (Balance of Company-Owned Interconnection Facilities Prepayment) of <u>Attachment G</u> (Company-Owned Interconnection Facilities).
[SPECIFY DATE CERTAIN]	<u>Permit Application Filing Milestone</u> : Provide Company with documentation reasonably satisfactory to Company evidencing the filing by or on behalf of Seller of the following applications for Governmental Approvals required for the ownership, construction, operation and maintenance of the Facility: [INSERT LIST OF GOVERNMENTAL APPROVALS]
[SPECIFY DATE CERTAIN]	<u>Construction Financing Milestone</u> : Provide Company with documentation reasonably satisfactory to Company evidencing (i) the closing on financing for the Facility or (ii) the financial capability to construct the Facility
[SPECIFY DATE CERTAIN]	<u>Guaranteed Commercial Operations Date</u> .

**[ATTACHMENT L WILL BE REVISED TO REFLECT
THE RESULTS OF IRS]**

ATTACHMENT L
REPORTING MILESTONES

Reporting Milestone Date	Description of Each Reporting Milestone
[Date]	Seller shall provide Company with a copy of the executed Facility equipment, engineering, procurement and construction (" <u>EPC</u> "), or other general contractor, agreements.
[Date]	Seller shall provide Company with copies of executed purchase orders/contracts for the delivery and installation of Facility turbine(s)/generator(s) and the step-up transformer(s).
[Date]	Seller shall provide Company with copies, as applicable, of executed Facility operating agreements, [electric transmission and/or interconnection agreements (?)].
[Date]	Construction Start Date (as defined in the Definitions section of the Agreement).
[Date]	Seller shall have laid the foundation for all Facility buildings, generating facilities and step-up transformer facilities.
[Date]	The turbine(s)/inverter(s) shall have been installed at the Site.
[Date]	The step-up transformer shall have been installed at the Site.
[Date]	Seller shall have constructed Seller's Interconnection Facilities and such facilities are capable of being

energized.

[Date]

The Acceptance Test of the Facility
commences.

ATTACHMENT M
FORM OF LETTER OF CREDIT

Page 1 of 2

[Bank Letterhead]

[Date]

Beneficiary: **[Hawaiian Electric Company, HELCO or MECO, as appropriate]**

[Address]

[Bank's Name]

[Bank's Address]

Re: **[Irrevocable Standby Letter of Credit Number]**

Ladies and Gentlemen:

We hereby establish, in your favor, our irrevocable standby Letter of Credit Number _____ (this "Letter of Credit") for the account of **[Applicant's Name]** and **[Applicant's Address]** in the initial amount of \$ _____ **[dollar value]** and authorize you, Hawaiian Electric Company **[HELCO or MECO, as appropriate]** ("Beneficiary"), to draw at sight on **[Bank's Name]**.

Subject to the terms and conditions hereof, this Letter of Credit secures **[Project Entity Name]**'s certain obligations to Beneficiary under the Power Purchase Agreement dated as of _____ between **[Project Entity Name]** and Beneficiary.

This Letter of Credit is issued with respect to the following obligations:_____.

This Letter of Credit may be drawn upon under the terms and conditions set forth herein, including any documentation that must be delivered with any drawing request.

Partial draws of this Letter of Credit are permitted. This Letter of Credit is not transferable. Drafts on us at sight shall be accompanied by a Beneficiary's signed statement signed by a representative of Beneficiary substantially as follows:

The undersigned hereby certifies that (i) I am duly authorized to execute this document on behalf of Hawaiian

Electric Company [**HELCO or MECO, as appropriate**], and [(ii) the amount of the draft accompanying this certification is due and owing to Hawaiian Electric Company [**or HELCO or MECO, as appropriate**] under the terms of the Power Purchase Agreement dated as of _____, between _____, and Hawaiian Electric Company [**or HELCO or MECO, as appropriate**]] [(ii) the Letter of Credit will expire in less than thirty (30) days, it has not been replaced or extended and collateral is still required under Section _____ of the Power Purchase Agreement*].

Such drafts must bear the clause "**Drawn under [Bank's Name and Letter of Credit Number _____ and date of Letter of Credit.]**"

All demands for payment shall be made by presentation of originals or copies of documents, or by facsimile transmission of documents to [**Bank Fax Number**] or other such number as specified from time to time by the bank. If presentation is made by facsimile transmission, you may contact us at [**Bank Phone Number**] to confirm our receipt of the transmission. Your failure to seek such a telephone confirmation does not affect our obligation to honor such a presentation. If presented by facsimile, original documents are not required.

This letter of credit shall expire one year from the date hereof. Notwithstanding the foregoing, however, this letter of credit shall be automatically extended (without amendment of any other term and without the need for any action on the part of the undersigned or Beneficiary) for one year from the initial expiration date and each future expiration date unless we notify you in writing at least thirty (30) days prior to any such expiration date that this letter of credit will not be so extended. Any such notice shall be delivered by registered or certified mail, or by FedEx, both to [**revise for HELCO or MECO, as appropriate**]:

Manager, Renewable Acquisition
Hawaiian Electric Company, Inc.
220 South King Street, 21st Floor
Honolulu, Hawai'i 96813

and to

* For draw relating to lapse of Letter of Credit while credit support is still required pursuant to the Power Purchase Agreement.

February 2018 RDG (Wind) (2/1/18)

SVP & Chief Financial Officer
Hawaiian Electric Company, Inc.
900 Richards Street, 4th Floor
Honolulu, Hawai'i 96813

We hereby agree with drawers that drafts and documents as specified above will be duly honored upon presentation to **[Bank's Name]** and **[Bank's Address]** if presented on or before the then-current expiration date hereof.

Payment of any amount under this Letter of Credit by **[Bank]** shall be made as the Beneficiary shall instruct on the next Business Day after the date the **[Bank]** receives all documentation required hereunder, in immediately available funds on such date. As used in this Letter of Credit, the term "Business Day" shall mean any day other than a Saturday or Sunday or any other day on which banks in the State of Hawai'i are authorized or required by law to be closed.

Unless otherwise expressly stated herein, this irrevocable standby letter of credit is issued subject to the rules of the International Standby Practices, International Chamber of Commerce publication no. 590 ("ISP98").

[Bank's Name]:

By: _____
[Authorized Signature]

ATTACHMENT N
ACCEPTANCE TEST GENERAL CRITERIA

**[THIS ATTACHMENT WILL NEED TO BE MODIFIED
BASED ON THE TYPE AND DESIGN OF THE FACILITY]**

Upon final completion of Company review of the Facility's drawings, final test criteria and procedures shall be agreed upon by Company and Seller no later than thirty (30) Days prior to conducting the Acceptance Test in accordance with the Agreement. The Acceptance Test may include the following:

1. Interconnection:

- (a) Based on manufacturer's specification, test the local operation of the Facility's [REDACTED] kV breakers, which connect the Facility to Company System - must open and close locally using the local controls. Test and ensure that the status shown on the Energy Management System (EMS) is the same as the actual physical status in the field.
- (b) Remotely test the operation of the Facility's [REDACTED] kV breakers which connect the Facility to Company System - must open and close remotely from Company's EMS. Test and ensure that the status shown on the EMS is the same as the actual physical status in the field.
- (c) Relay test engineers to connect equipment and simulate certain inputs to test and ensure that the protection schemes such as any under/over frequency and under/over voltage protection or the Direct Transfer Trip operate as designed. (For example, a fault condition may be simulated to confirm that the breaker opens to sufficiently clear the fault. Additional scenarios may be tested and would be outlined in the final test criteria and procedures.) Seller to also test the synchronizing mechanisms to which the Facility would be synchronizing and closing into the Company System to ensure correct operation. Other relaying also to be tested as specified in the protection review of the IRS and on the single line diagram, Attachment E (Single-Line Drawing and Block Interface Diagram) for the Facility.

- (d) All [REDACTED] kV breaker disconnects and other high voltage switches will be inspected to ensure they are properly aligned and operated manually or automatically (if designed).
- (e) Switching Station inspections - The Switching Station may be inspected to test and ensure that the equipment that Seller has installed is installed and operating correctly based upon agreed-to design. Wiring may be field verified on a sample basis against the wiring diagrams to ensure that the installed equipment is wired properly. The grounding mat at the Switching Station may be tested to make sure there is adequate grounding of equipment.
- (f) Communication testing - Communication System testing to occur to ensure correct operation. Detailed scope of testing will be agreed by Company and Seller to reflect installed systems and communication paths to tie the Facility to Company's communications system.
- (g) Various contingency scenarios to be tested to ensure adequate operation, including testing contingencies such as loss of communications, and fault simulations to ensure that the Facility's [REDACTED] kV breakers open as they are designed to open. (Back up relay testing)

2. Witness of Facility protection scheme testing:

- (a) Company may have a representative on-site when Seller performs any testing dealing with Seller's protection schemes such as any under/over voltage or under/over frequency protection schemes to ensure they meet the performance requirements of this Agreement and the IRS.

3. Telephone Communication:

- (a) Test to confirm Company has a direct line to the Facility control room at all times and that it is programmed correctly.
- (b) Test to confirm that the Facility operators can sufficiently reach Company System Operator.

If agreed by the Parties in writing, some requirements may be postponed to the Control Systems Acceptance Test.

ATTACHMENT O
CONTROL SYSTEM ACCEPTANCE TEST CRITERIA

**[THIS ATTACHMENT WILL NEED TO BE MODIFIED
BASED ON THE TYPE AND DESIGN OF THE FACILITY]**

Final test criteria and procedures shall be agreed upon by Company and Seller no later than thirty (30) Days prior to conducting the Control System Acceptance Test ("CSAT") in accordance with Good Engineering and Operating Practices and with the terms of this Agreement. The Control System RTU Points List is necessary for the effective operation of the Company System and will be tested during the Control System Acceptance Test.

The Control System Acceptance Test is comprised of two parts, a set of onsite (at Facility) specific tests and a monitoring performance test. These tests may include the following:

On-site Tests:

1. SCADA Test to verify the status and analog telemetry, and if the remote controls between the Company's EMS and the Facility are working properly end-to-end.
2. Dispatch Test to verify if the Facility's active power limit controls and the Active Power Control Interface with the Company's EMS are working properly. The Test is generally conducted by setting different active power setpoints and limits and observing the proper dispatch at the appropriate ramp rate limiting of the Facility's real power output.
3. Control Test for Voltage Regulation to verify the Facility can properly perform automatic voltage regulation as defined in this Agreement. Test is generally conducted by making small adjustments of the voltage setpoint and verifying by observation that the Facility regulates the voltage at the point of regulation to the setpoint by delivering/receiving reactive power to/from the Company System to maintain the applicable setpoint according to the reactive power control and the reactive amount requirements of Sections 3(a) (Reactive Power Control) and Section 3(b) (Reactive Amount) of Attachment B (Facility Owned by Seller) to this Agreement.
[DRAFTING NOTE: NEEDS TO BE REVISED FOR MECO FOR TESTING OF POWER FACTOR.]

4. Frequency Regulation Control Test to verify the Facility provides a frequency droop response as defined in this Agreement. Test is generally conducted by making adjustments of the frequency reference setting and verifying by observation that the Facility responds per droop and deadband settings.
5. Loss-of-Communication Test to verify the Facility will properly shutdown upon the failure of the direct-transfer-trip communication system. Test is generally conducted by simulating a communications failure and observing the proper shutdown of the Facility.

Monitoring Test:

- a) The monitoring test requires the Facility to operate as it would in normal operations.
- b) To ensure useful and valid test data is collected, the monitoring test shall end when one of the following criteria is met:
 - A. The Facility's power production is greater than 85% of its Allowed Capacity, for at least four (4) hours in any continuous 24-hour CSAT period.
 - B. The recorded renewable energy resource at the Facility is above **a Measured Wind Speed of 9 meters per second** for at least eight (8) hours in any continuous 48-hour CSAT period.
 - C. 14 continuous Days from the start of the CSAT.
- c) At the end of the test, an evaluation period is selected based on the criteria that triggered the end of the test.
- d) The performance of the Facility during the period of the successfully completed monitoring test is evaluated for, e.g. voltage regulation, frequency response, dispatch control, operating limits and ramp rate performance, to verify the performance meets the requirements of this Agreement. The Facility is considered to have complied with a requirement if the Facility was compliant with the requirement at least 99.0% of the time during the evaluation period and the Facility does not grossly violate the requirement when the Facility was in violation. The Parties understand and agree that these compliance conditions are limited only to determining whether the Facility successfully completes the CSAT monitoring test and are not for use in determining compliance during Commercial Operations, shall not be

considered a waiver of any of the performance standards of Seller, all of which are hereby reserved, and shall not alleviate Seller from any of its obligations under the Agreement.

ATTACHMENT P
SALE OF FACILITY BY SELLER

1. Company's Right of First Negotiation Prior to End of the Term.
 - (a) Right of First Negotiation. Should Seller ever desire to dispose of its right, title, or interest in the Facility, in whole or in part, other than the sale and leaseback of the Facility to provide financing for the Facility, it shall first offer to sell such interest at the fair market value to Company. Seller shall not solicit any offers for the sale of the Facility with any other entity without first negotiating with Company for at least six (6) months. The Parties may agree in writing to extend this period for negotiations. (Such 6-month period, as extended as aforesaid, is referred to herein as the "Right of First Negotiation Period".) During the Right of First Negotiation Period, the Parties shall negotiate in good faith concerning a purchase by Company unless, during that period, Company gives written notice that such negotiations are terminated. If, at the conclusion of the Right of First Negotiation Period, the Parties have not reached an agreement on the sale of the Facility to Company because the Parties cannot agree on the fair market value of the Facility, the fair market value of the Facility shall be determined in accordance with Section 3 (Procedure to Determine Fair Market Value of the Facility) of this Attachment P (Sale of Facility by Seller).
 - (b) Change in Ownership Interests and Control. Disposition of an interest in the Facility described in Section 1(a) (Right of First Negotiation) of this Attachment P (Sale of Facility by Seller) shall include and be deemed to include and occur upon:
 - (i) The disposition, sale, assignment or transfer, directly or indirectly, by merger, consolidation, reorganization, operation of law, or otherwise, of (A) any interest in Seller, and (B) any interest in any entity which holds a legal, beneficial or other interest in Seller, whether directly or through one or more intermediary entities (collectively, an "Ownership Interest");
 - (ii) The creation or issuance of ownership interests (whether shares, partnership interests, membership

interests, or other equity) which dilutes or reduces the existing ownership interests of any such entities, and (B) any change in the voting power or right to manage such entities (collectively, "Ownership Control"); provided, however, that Ownership Interest and Ownership Control shall not apply to an entity that is publicly traded on an established exchange.

Company's rights set forth in Section 1(a) (Right of First Negotiation) of this Attachment P (Sale of Facility by Seller) shall apply if in a single transaction or a series of related or unrelated transactions there is or will occur (A) a change of 50% or more in the Ownership Interest, or (B) any change in Ownership Control; provided, however, a sale or transfer of any interest in Seller or the Facility to one or more Companies directly or indirectly controlling, controlled by or under common control with the Seller shall not trigger a right of first negotiation under Section 1(a) (Right of First Negotiation of this Attachment P (Sale of Facility by Seller)).

- (c) Purchase and Sale Agreement and PUC Approval. In the event that Company does exercise its right to purchase such interest in the Facility under Section 1(a) (Right of First Negotiation) of this Attachment P (Sale of Facility by Seller) and the Parties conclude a purchase and sale agreement, such agreement shall contain, at a minimum, the terms set forth in Section 4 (Purchase and Sale Agreement) of this Attachment P (Sale of Facility by Seller), and such agreement shall be subject to PUC approval as provided in Section 5 (PUC Approval) of this Attachment P (Sale of Facility by Seller).
- (d) Right of First Refusal. In the event the Parties fail to agree upon a sale of the Facility to Company (i) prior to the expiration of the Right of First Negotiation Period, or (ii) within thirty (30) Days of the determination of the Appraised Fair Market Value of the Facility as provided in Section 3 (Procedure to Determine Fair Market Value of the Facility) of this Attachment P (Sale of Facility by Seller), the provisions of this Section 1(d) (Right of First Refusal) shall apply if (aa) Seller thereafter offers to sell the Facility to a third party for less than (as applicable) the final amount Company had offered to purchase the Facility or the Appraised Fair Market Value or (bb) an

Ownership Interest that could result in a change of Ownership Control is offered for sale to a third party that is less than the proportionate share of (as applicable) the final amount Company had offered to purchase the Facility or the Appraised Fair Market Value. (By way of example, if the final amount offered by Company to purchase the Facility was \$100, and the Ownership Interest being offered for sale is 75%, the "proportionate share" is \$75, such that an offer to sell such Ownership Interest for less than \$75 would trigger this Section 1.1(d) (Right of First Refusal). Seller shall notify Company in writing of an offer that triggers this Section 1(d) (Right of First Refusal) and Company shall have the right to purchase the Facility for the amount of such offer on similar terms and conditions; provided that Company shall have three (3) months in which to notify Seller of its intent to exercise this right. If the offer of which Seller notifies Company as aforesaid is an offer to sell the Facility, Company shall have the right to purchase the Facility for the amount of such offer on similar terms and conditions. If the offer of which Seller notifies Company as aforesaid is an offer to sell an Ownership Interest that could result in a change in Ownership Control, Company shall have the right to purchase the Facility by a price that is proportionate to the amount at which such Ownership Interest was offered on the terms and conditions to be negotiated by the Parties on the basis of Section 4 (Purchase and Sale Agreement). (By way of example, if a 75% Ownership Interest is being offered for sale at \$75, the proportionate amount at which Company shall have the right to purchase the Facility would be \$100.)

- (e) Seller's Right to Transfer. In the event that Company does not exercise its right to purchase such interest in the Facility under Section 1(a) (Right of First Negotiation) of this Attachment P (Sale of Facility by Seller), Seller shall have the right to transfer or sell such interest to any person or entity which proposes to acquire the Facility with the intent to continue the operation of the Facility in accordance with the provisions of this Agreement pursuant to an assignment of this Agreement, subject to the prior written consent of Company, which consent shall not be unreasonably withheld, conditioned or delayed. Company will consent to the assignment of this Agreement to the purchaser

upon being reasonably satisfied that the assignee (i) has the qualifications or has contracted with an entity having the qualifications to operate the Facility in a manner consistent with the terms and conditions of this Agreement and (ii) has provided Company with evidence satisfactory to Company of its creditworthiness and ability to perform its financial obligations hereunder (including such guarantees as Company deems appropriate) in a manner consistent with the terms and conditions of this Agreement.

2. Company's Right of First Negotiation to Purchase at End of Term.

- (a) Option of Exclusive Negotiation Period. Company shall have the option of an exclusive negotiation period to negotiate a purchase of the Facility on the last Day of the Term, and all rights of Seller therein or relating thereto. Company shall indicate its preliminary interest in exercising the option for exclusive negotiation by delivering to Seller a notice of its preliminary interest not less than two (2) years prior to the last Day of the Term. If Company fails to deliver such notice by such date, Company's option shall terminate.
- (b) Negotiations. Once Company has given such notice of preliminary interest to Seller, for a period not to exceed three months, Company shall have the exclusive right to negotiate in good faith with Seller the terms of a purchase and sale agreement pursuant to which Company may purchase the Facility, which purchase and sale agreement shall include, without limitation, the terms set forth in Section 4 (Purchase and Sale Agreement) of this Attachment P (Sale of Facility by Seller). The Parties may agree in writing to extend this period for negotiations. (Such period, as extended as aforesaid, is referred to herein as the "Exclusive Negotiation Period.") Seller shall not solicit any offers or negotiate the terms for the sale of the Facility with any other entity during the Exclusive Negotiation Period, unless, during the Exclusive Negotiation Period, Company gives written notice that such negotiations are terminated. If, at the conclusion of the Exclusive Negotiation Period, the Parties have not reached an agreement on the sale of the Facility to Company because the Parties cannot agree on the fair market value of the Facility, the fair market value of

the Facility shall be determined in accordance with Section 3 (Procedure to Determine Fair Market Value of the Facility) of this Attachment P (Sale of Facility by Seller).

- (c) Purchase and Sale Agreement and PUC Approval. In the event that Company exercises its right of exclusive negotiation under Section 2(a) (Option of Exclusive Negotiation Period) of this Attachment P (Sale of Facility by Seller) and the Parties conclude a purchase and sale agreement pursuant to Section 2(b) (Negotiations) of this Attachment P (Sale of Facility by Seller), such agreement shall contain, at a minimum, the terms set forth in Section 4 (Purchase and Sale Agreement) of this Attachment P (Sale of Facility by Seller), and such agreement shall be subject to PUC approval as provided in Section 5 (PUC Approval) of this Attachment P (Sale of Facility by Seller).
- (d) Right of First Refusal. In the event the Parties fail to agree upon a sale of the Facility to Company
- (i) prior to the expiration of the Exclusive Negotiation Period provided in Section 2(b) (Negotiations) of this Attachment P (Sale of Facility by Seller), or
- (ii) within thirty (30) Days of the determination of the Appraised Fair Market Value of the Facility as provided in Section 3 (Procedure to Determine Fair Market Value of the Facility) of this Attachment P (Sale of Facility by Seller), and Seller thereafter offers to sell the Facility to a third party for less than the final amount Company had offered to purchase the Facility or the Appraised Fair Market Value (as applicable), Seller shall notify Company in writing of such offer and Company shall have the right to purchase the Facility for the amount of such offer and on no less favorable terms and conditions; provided, however, that Company shall have three (3) months in which to notify Seller of its intent to exercise this right.
3. Procedure to Determine Fair Market Value of the Facility.
- (a) If, at the conclusion of the Right of First Negotiation Period or the Exclusive Negotiation Period, or if the Parties have agreed to effectuate a sale of the Facility pursuant to Section 24.5 (Consolidation and Lease) and are unable to agree on the fair market value of the Facility, the Parties have not reached an agreement on the sale of the Facility to Company because the Parties

cannot agree on the fair market value of the Facility, each of Company and Seller shall engage the services of an independent appraiser experienced in appraising power generation assets similar to the Facility to determine separately the fair market value of the Facility. Subject to the appraisers' execution and delivery to Seller of a suitable confidentiality agreement in form reasonably acceptable to Seller, Seller shall provide both appraisers full access to the books, records and other information related to the Facility required to conduct such appraisal. Company shall pay all reasonable fees and costs of both appraisers, subject to Section 3(c) of this Attachment P (Sale of Facility by Seller). Each of Company and Seller shall use reasonable efforts to cause its appraisal to be completed within two (2) months following the engagement of the independent appraisers. If for any reason (other than failure by Seller to provide full access to Company's appraiser) one of the appraisals is not completed within such two (2) month period, the results of the other, completed appraisal shall be deemed to be the Appraised Fair Market Value of the Facility. Each Party may provide to both appraisers (with copies to each other) a list of factors which the Parties suggest be taken into consideration when the appraisers generate their appraisals.

- (b) Company and Seller shall exchange the results of their respective appraisals when completed and, in connection therewith, the Parties and their appraisers shall confer in an attempt to agree upon the fair market value of the Facility.
- (c) If, within thirty (30) Days after completion of both appraisals, the Parties cannot agree on a fair market value for the Facility, within ten (10) Days thereafter the first two appraisers shall by mutual consent choose a third independent appraiser. If the first two appraisers fail to agree upon a third appraiser, such appointment shall be made by DPR upon application of either Party. The Parties shall direct the third appraiser (i) to select one of the appraisals generated by the first two appraisers as the Appraised Fair Market Value of the Facility (without compromise, aka "baseball" arbitration), and (ii) to complete his or her work within one month following his or her retention. If the third appraiser selects the appraisal originally

generated by Seller's appraiser, Company shall pay the fees and costs of the third appraiser. If the third appraiser selects the appraisal originally generated by Company's appraiser, Seller shall pay the fees and costs of the third appraiser and shall pay or reimburse Company for the costs of Seller's original appraiser.

(d) The "Appraised Fair Market Value of the Facility" means the fair market value determined pursuant to Section 3(a) or Section 3(c) of this Attachment P (Sale of Facility by Seller) as applicable.

4. Purchase and Sale Agreement. The purchase and sale agreement concluded by the Parties pursuant to Section 1(a) (Right of First Negotiation) and Section 2(b) (Negotiations) of this Attachment P (Sale of Facility by Seller) (as applicable) shall contain, among other provisions, the following:

- (a) Seller shall, as of the closing of the sale, convey good and marketable title to the Facility and Site, including all rights of Seller in the Facility or relating thereto, free and clear of all liens, claims, encumbrances, or rights of others, except as approved by Company in writing;
- (b) Seller shall assign or otherwise make available to Company all of Seller's interest in all Project Documents and Governmental Approvals that are then in effect and that are utilized for the operation or maintenance of the Facility;
- (c) Seller shall execute and deliver to Company such deeds, bills of sale, assignments and other documentation as Company may request to convey good and marketable title to the Facility free from all liens, claims, encumbrances, or rights of others;
- (d) Seller shall cause all liens on the Facility for monies owed (including liens arising from Financing Documents), and any liens in favor of Seller's affiliates, to be released prior to closing on the sale of the Facility to Company;
- (e) Seller shall warrant, as of the date of the closing of the sale of the Facility to Company, good and marketable title to the Facility, free and clear of all other liens, claims, encumbrances and rights of others, except as approved by Company in writing;

- (f) Company shall have no liability for damages (including without limitation, any development and/or investment losses, liabilities or damages, and other liabilities to third parties) incurred by Seller on account of Company's purchase of the Facility, nor any other obligation to Seller except for the purchase price, and Seller shall indemnify Company against any such losses, liabilities or damages;
- (g) Company shall assume all of Seller's obligations with respect to the Facility accruing from and after the date of closing on the sale of the Facility to Company, including (i) to the extent assignable, all Permits held by, for, or related to the Facility, and (ii) all of Seller's agreements with respect to the Facility provided to and approved by Company at least [__] Days prior to the date of closing on the sale of the Facility to Company, except for such agreements Company has elected to terminate, in which case any related termination expenses shall be, at Company's option, paid directly by Company and deducted from the purchase price;
- (h) Seller shall indemnify Company against all of Seller's obligations with respect to the Facility accruing through the date of closing the sale of the Facility to Company;
- (i) Seller shall warrant that the Facility is in good operating order and repair, ordinary wear and tear excepted, in condition to perform in accordance with past practice, with no major maintenance items deferred, except as disclosed to and approved by Company in writing at least [__] Days prior to the date of closing on the sale of the Facility to Company;
- (j) Seller shall warrant that, except as disclosed to and approved by Company in writing at least [__] Days prior to the date of closing on the sale of the Facility to Company, the Facility conforms and has been operated by Seller in conformity with all Laws;
- (k) Seller shall warrant that Seller provided full access to Company and each appraiser in connection with the procedure to determine fair market value provided in Section 3 (Procedure to Determine Fair Market Value of the Facility); and

- (1) If applicable, Seller's lease of the Site from Company will terminate and Seller will relinquish all rights, privileges and obligations relating to such lease.
5. PUC Approval. Any purchase and sale agreement related to the Facility entered into by the Parties is subject to approval by the PUC and the Parties' respective obligations thereunder are conditioned upon receipt of such approval, except as specifically provided otherwise therein.
- (a) Company shall submit the purchase and sale agreement to the PUC for approval promptly after execution by both Parties, but Company does not extend any assurances that PUC approval will be obtained. Seller will provide reasonable cooperation to expedite obtaining an Approval Order from the PUC, including providing information requested by the PUC and parties to the PUC proceeding in which approval is being sought. Seller understands that lack of cooperation may result in Company's inability to file an application with the PUC and/or failure to receive PUC approval. For the avoidance of doubt, Company has no obligation to seek reconsideration, appeal, or other administrative or judicial review of any unfavorable PUC order. The Parties agree that neither Party has control over whether or not a PUC approval order will be issued and each Party hereby assumes any and all risk arising from, or relating in any way to, the inability to obtain a satisfactory PUC order and hereby releases the other Party from any and all claims relating thereto.
 - (b) Seller shall seek participation without intervention in the PUC docket for approval of the purchase and sale agreement pursuant to applicable rules and orders of the PUC. The scope of Seller's participation shall be determined by the PUC. However, Seller expressly agrees to seek participation for the limited purpose and only to the extent necessary to assist the PUC in making an informed decision regarding the approval of the purchase and sale agreement. If the Seller chooses not to seek participation in the docket, then Seller expressly agrees and knowingly waives the right to claim, before the PUC, in any court, arbitration or other proceeding, that the information submitted and the application requesting the PUC approval are insufficient to meet Company's burden of justifying that the terms of the purchase and sale agreement are just and reasonable and in the public interest, or otherwise deficient in any

manner for purposes of supporting the PUC's approval of the purchase and sale agreement. Seller shall not seek in the docket and Company shall not disclose any confidential information to Seller that would provide Seller with an unfair business advantage or would otherwise harm the position of others with respect to their ability to compete on equal and fair terms.

- (c) In order to constitute an Approval Order from the PUC under this Section 5 (PUC Approval) of this Attachment P (Sale of Facility by Seller), the order must approve the purchase and sale agreement, Company's funding arrangements and Company's acquisition of the Facility, shall not contain any terms and conditions deemed to be unacceptable by Company, and be in a form deemed reasonable by Company in its sole, but non-arbitrary, discretion.
- (d) The Final Non-Appealable Order from the PUC must be obtained within eighteen (18) months of the submission of the purchase and sale agreement to the PUC, or any extension of such period as agreed by the Parties in writing. The term "Final Non-appealable Order from the PUC" means an Approval Order from the PUC (i) that is not subject to appeal to any Circuit Court of the State of Hawai'i, Intermediate Court of Appeals of the State of Hawai'i, or the Supreme Court of the State of Hawai'i, because the period permitted for such an appeal has passed without the filing of notice of such an appeal, or (ii) that was affirmed on appeal to any Circuit Court of the State of Hawai'i, Intermediate Court of Appeals of the State of Hawai'i, or the Supreme Court of the State of Hawai'i, or was affirmed upon further appeal or appellate process, and that is not subject to further appeal, because the jurisdictional time permitted for such an appeal and/or further appellate process such as a motion for reconsideration or an application for writ of certiorari has passed without the filing of notice of such an appeal or the filing for further appellate process.
- (e) If a Final Non-Appealable Order from the PUC has not been obtained prior to the deadline provided in Section 5(b) of this Attachment P (Sale of Facility by Seller), either Party may give written notice to the other Party that it does not wish to proceed further with a sale of the Facility to Company.

- (f) If the Final Non-appealable Order from the PUC does not satisfy the conditions set forth in Section 5(a) of this Attachment P (Sale of Facility by Seller), either (i) Parties may agree to renegotiate and submit a revised purchase and sale agreement to the PUC, or (ii) either Party may give written notice to the other Party that it does not wish to proceed further with a sale of the Facility to Company.
6. Make Whole Amount. For purposes of Section 24.5 (Consolidation and Lease) the "Make Whole Amount" shall be equal to the sum of the following: (a) Seller's book value (including depreciation on a twenty-five (25) year straight line basis) of all actual verifiable costs of studies, designs, engineering, and construction of the Facility and all Interconnection Facilities (including any Company-Owned Interconnection Facilities paid for by Seller), including cancellation charges and other costs of unwinding construction and demobilization if the determination is made prior to the Commercial Operation Date, (b) Seller's book value of all actual verifiable costs and expenses acquiring real estate rights for the Facility and Interconnection Facilities, (c) Seller's book value of all actual verifiable costs and expenses incurred in obtaining Governmental Approvals, (d) Seller's book value of all actual verifiable costs of financing the Facility and the Interconnection Facility, including fees and expenses of bankers, consultants and counsel, and any discounts or premiums paid in connection with any financing, (e) any actual verifiable costs of repaying any financing in connection with a sale, including prepayment penalties or premiums, make whole payments, minimum interest payments, breakage fees, payments on account of taxes, duties and other costs, and other costs of unwinding swaps or other hedges, (f) other breakage, make whole or indemnity payments arising as the result of Company's purchase of the Facility, (g) tax costs, including recapture of federal or state tax credits and payment of transfer taxes, and (h) interest on the foregoing amounts at annual rate equal to the Prime Rate plus two percent (2%) as in effect from time to time from the date incurred through the date of payment, with all such costs being demonstrated by Seller with support and verified by Company. The items described in clauses (e), (f) and (g) (and clause (h) to the extent applicable to clauses (e), (f) and/or (g)) are referred to as the "Financial Termination Costs".

ATTACHMENT Q
[RESERVED]

ATTACHMENT R
REQUIRED INSURANCE

(See also Article 18 (Insurance))

1. Worker's Compensation and Employers' Liability. This coverage shall include Worker's Compensation, Temporary Disability and other similar insurance required by applicable State or U.S. federal laws. If exposure exists, coverage required by the Longshore and Harbor Worker's Compensation Act (33 U.S.C. §688) shall be included. Employers' Liability coverage limits shall be no less than:

Bodily Injury by Accident - \$1,000,000 each Accident
Bodily Injury by Disease - \$1,000,000 each Employee
Bodily Injury by Disease - \$1,000,000 policy limit

2. General Liability Insurance.

(i) This coverage shall include Commercial General Liability Insurance or the reasonable equivalent thereof, covering all operations by or on behalf of Seller. Such coverage shall provide insurance for bodily injury and property damage liability for the minimum limits of liability indicated below and shall include coverage for:

- (a) Premises, operations, and mobile equipment,
- (b) Products and completed operations,
- (c) Claims resulting from alleged damage to the environment and damage or injury caused by hazardous conditions or hazardous materials to the extent such coverage is appropriate and available at a commercially reasonable cost,
- (d) Blanket contractual liability,
- (e) Broad form property damage (including completed operations),
- (f) Explosion, collapse and underground hazard,
- (g) Personal injury liability, and
- (h) Failure to supply liability.

- (ii) Limits of liability for Bodily Injury & Property Damage shall be:
 - \$10,000,000 combined single limit per occurrence and;
 - \$20,000,000 aggregate annually
 - (iii) If coverage is written on a claims-made basis, the Seller warrants that any retroactive date applicable to coverage under the policy precedes the Execution Date; and that continuous coverage will be maintained or an extended discovery period will be exercised for a period of three (3) years beginning from the end of Term.
 - (iv) Coverage limits may be satisfied using Umbrella and/or Excess Liability insurance policies.
3. Automobile Liability Insurance. This insurance shall include coverage for owned, leased and non-owned automobiles. The minimum limits of liability shall be a combined single limit for bodily injury and property damage of Two Million Dollars (\$2,000,000) for each occurrence and in the aggregate annually. The policy shall be endorsed to include Transportation Pollution Liability insurance, covering hazardous materials to be transported by Seller, as appropriate.
4. Builders All Risk Insurance. This insurance shall include but not be limited to coverage for wind including named windstorm, earthquake, flood, perils, property in transit (excluding ocean transit), off-site storage - property in temporary storage or assembly away from the project site, testing, covering all materials, equipment, machinery and supplies of any nature whatsoever, the property of the Seller or of others for which the Seller may have assumed responsibility, used or to be used in or incidental to the site preparation, demolition of existing structures, erection and/or fabrication and/or reconstruction and/or repair of the project insured, including temporary works (all scaffolding, formworks, fences, shoring, hoarding, false work and temporary buildings and all incidental to the project) from the start of construction through the earlier of the Commercial Operations Date or the effective date of the policy coverage set forth in Section 5 (All Risk Property/Comprehensive Boiler and Machinery Insurance (Upon Completion of Construction)). The amount of coverage shall be purchased on a full replacement cost basis, except for earthquake and flood perils which shall be no less than Twenty Million Dollars (\$20,000,000), if such insurance

amounts are appropriate and available on commercially reasonable terms. The coverage shall be written on an "All Risks" completed value form and may allow for reasonable other sublimits for transit and for incidental offsite storage. Coverage shall be extended to include testing. Such policies shall be endorsed to require that the coverage afforded shall not be canceled (except for nonpayment of premiums) or reduced without at least thirty (30) Days' prior written notice to Seller and Company; provided, however, that such endorsement shall provide (i) that the insurer may not cancel the coverage for non-payment of premium without giving Seller and Company ten (10) Days' notice that Seller has failed to make timely payment thereof, and (ii) that, subject to the consent of the Facility Lender, Seller or Company shall thereupon have the right to pay such premium directly to the insurer.

5. All Risk Property/Comprehensive Boiler and Machinery Insurance (Upon Completion of Construction). This insurance shall provide All Risk Property Coverage (including the perils of wind including named windstorm, earthquake, and flood) and Comprehensive Boiler and Machinery Coverage against damage to the Facility. The amount of coverage shall be purchased on a full replacement cost basis (no coinsurance shall apply) except for earthquake and flood perils which shall be no less than Twenty Million Dollars (\$20,000,000), if such insurance amounts are appropriate and available on commercially reasonable terms. Such coverage may allow for other reasonable sublimits. Such policies shall be endorsed to require that the coverage afforded shall not be canceled (except for nonpayment of premiums) or reduced without at least thirty (30) Days' prior written notice to Seller and Company; provided, however, that such endorsement shall provide (i) that the insurer may not cancel the coverage for non-payment of premium without giving Seller and Company ten (10) Days' notice that Seller has failed to make timely payment thereof, and (ii) that, subject to the consent of the Facility Lender, Seller or Company shall thereupon have the right to pay such premium directly to the insurer.

6. Business Interruption Insurance (Upon Completion of Construction). This insurance shall provide coverage for all of Seller's costs to the extent that they would not be eliminated or reduced by the failure of the Facility to operate for a period of at least twelve (12) months following a covered physical damage loss deductible period or reasonable dollar deductible.

7. Project Liability Errors and Omissions. Seller shall obtain adequate protection against project liability errors and omissions on account of negligent actions or inactions of architects, engineers, contractors and subcontractors involved in the design and/or construction of the Facility. This protection may be provided through any one or more of the following mechanisms: (i) construction contract(s) with the above parties who have sufficient financial creditworthiness to cover project liability errors and omissions; (ii) other agreement(s) with the above parties; or (iii) reserve account(s) which may be used to correct material deficiencies associated with the Facility as a result of negligent actions or inactions of the above parties.

8. Ocean Transit. Seller shall take reasonable action to ensure that the risk of loss or damage to any material items of equipment which are subject to ocean transit is adequately protected against by the terms of delivery from contractors or suppliers of such equipment or Seller's own insurance coverage.

ATTACHMENT S
FORM OF MONTHLY PROGRESS REPORT

1. Instructions

Any capitalized terms used in this report which are not defined herein shall have the meaning ascribed to them in the Power Purchase Agreement for Renewable As-Available Energy by and between _____, a **[Delaware limited liability company]** ("Seller"), and **[HECO/HELCO/MECO, as appropriate]**, a Hawai'i corporation, dated _____, (the "Agreement").

In addition to the remedial action plan requirement set forth in Article 13 of the Agreement, Seller shall review the status of each Construction Milestone of the construction schedule (the "Schedule") for the Facility and identify such matters referenced in clauses (i)-(v) below as known to Seller and which in Seller's reasonable judgment are expected to adversely affect the Schedule, and with respect to any such matters, shall state the actions which Seller intends to take to ensure that the Construction Milestones will be attained by their required dates. Such matters may include, but shall not be limited to:

(i) Any material matter or issue arising in connection with a Government Approval, or compliance therewith, with respect to which there is an actual or threatened dispute over the interpretation of a law, actual or threatened opposition to the granting of a necessary Governmental Approvals, any organized public opposition, any action or expenditure required for compliance or obtaining approval that Seller is unwilling to take or make, or in each case which could reasonably be expected to materially threaten or prevent financing of the Facility, attaining any Construction Milestone, or obtaining any contemplated agreements with other parties which are necessary for attaining any Construction Milestone or which otherwise reasonably could be expected to materially threaten Seller's ability to attain any Construction Milestone.

(ii) Any development or event in the financial markets or the independent power industry, any change in taxation or accounting standards or practices or in Seller's business or prospects which reasonably could be expected to materially threaten financing of the Facility, attainment of any Construction Milestone or materially threaten any contemplated agreements with other parties which are necessary for attaining any Construction Milestone or could otherwise reasonably be expected to materially threaten Seller's ability to attain any Construction Milestone;

(iii) A change in, or discovery by Seller of, any legal or regulatory requirement which would reasonably be expected to materially threaten Seller's ability to attain any Construction Milestone;

(iv) Any material change in the Seller's schedule for initiating or completing any material aspect of the Facility;

(v) The status of any matter or issue identified as outstanding in any prior Monthly Progress Report and any material change in the Seller's proposed actions to remedy or overcome such matter or issue.

For the purpose of this report, "EPC Contractor" means the contractor responsible for engineering, procurement and construction of the Facility, including Seller if acting as contractor, and including all subcontractors.

2. Executive Summary

2.1 Major activities completed

Please provide a cumulative summary of the major activities completed for each of the following aspects of the Facility (provide details in subsequent sections of this report):

- 2.1.1 **[Insert Construction Milestones from Attachment K and Attachment L, if needed]**
- 2.1.2 Financing
- 2.1.3 Governmental Approvals for Development
- 2.1.4 Site Control
- 2.1.5 Land Rights for Company-Owned Interconnection Facilities
- 2.1.6 Design and Engineering
- 2.1.7 Major Equipment Procurement
- 2.1.8 Construction
- 2.1.9 Interconnection

2.1.10 Startup Testing and Commissioning

2.2. Major activities recently performed

Please provide a summary of the major activities performed for each of the following aspects of the Facility since the previous report (provide details in subsequent sections of this report):

2.2.1 [Insert Construction Milestones from Attachment K and Attachment L, if needed]

2.2.2 Financing

2.2.3 Development Permits

2.2.4 Site Control

2.2.5 Land Rights for Company-Owned Interconnection Facilities

2.2.6 Design and Engineering

2.2.7 Major Equipment Procurement

2.2.8 Construction

2.2.9 Interconnection

2.2.10 Startup Testing and Commissioning

2.3 Major activities planned but not completed

Please provide a summary of the major activities that were planned to be performed since the previous report but not completed as scheduled, including the reasons for not completing the activities, for each of the following aspects of the Facility:

2.3.1 [Insert Construction Milestones from Attachment K and Attachment L, if needed]

2.3.2 Financing

2.3.3 Governmental Approvals for Development

2.3.4 Site Control

- 2.3.5 Land Rights for Company-Owned Interconnection Facilities
- 2.3.6 Design and Engineering
- 2.3.7 Major Equipment procurement
- 2.3.8 Construction
- 2.3.9 Interconnection
- 2.3.10 Startup Testing and Commissioning

2.4 Major activities expected during the current month

Please provide a summary of the major activities to be performed during the current month for each of the following aspects of the Facility (provide details in subsequent sections of this report):

- 2.4.1 Construction Milestones
- 2.4.2 Financing
- 2.4.3 Governmental Approvals
- 2.4.4 Site Control
- 2.4.5 Land Rights for Company-Owned Interconnection Facilities
- 2.4.6 Design and Engineering
- 2.4.7 Major Equipment procurement
- 2.4.8 Construction
- 2.4.9 Interconnection
- 2.4.10 Startup Testing and Commissioning

3. Milestones

3.1 Milestone schedule

Please list all Construction Milestones specified in Attachment K and Attachment L and state the current status of each.

Construction Milestone	Milestone Date Specified in the Agreement	Status (e.g., on schedule, delayed due to [<i>specify reason</i>]; current expected completion date)
-------------------------------	--	--

3.2 Remedial Action Plan (if applicable)

Provide a detailed description of Seller's course of action and plan to achieve the missed Construction Milestones and all subsequent Construction Milestones by the Guaranteed Commercial Operation Date using the outline provided below.

- 3.2.1 Identify Missed Construction Milestone
- 3.2.2 Explain plans to achieve missed Construction Milestone
- 3.2.3 Explain plans to achieve subsequent Construction Milestones
- 3.2.4 Identify and discuss (a) delays in engineering schedule, equipment procurement, and construction and interconnection schedule and (b) plans to remedy delays as a result of the missed Construction Milestones

4. Financing

Please provide the schedule Seller intends to follow to obtain financing for the Facility. Include information about each stage of financing.

Activity (e.g., obtain \$xx for yy stage from zz)	Completion Date
	__/__/____ (expected / actual)
	__/__/____ (expected / actual)

5. Project Schedule

Please provide a copy of the current version of the overall Facility schedule (e.g., Work Breakdown Structure, Gantt chart, MS Project report, etc.). Include all major activities for Governmental Approvals for Development, design and engineering, procurement, construction, interconnection and testing.

6. Governmental Approvals

6.1 Environmental Impact Review

Please provide information about the primary environmental impact review for the Facility. Indicate whether dates are expected or actual.

Agency

Date of application/submission __/__/____
 (expected /
 actual)

**Date application/submission deemed
 complete by agency** __/__/____
 (expected /
 actual)

Date of initial study (if applicable) __/__/____
 (expected /
 actual)

Process (e.g., Notice of Exemption,
 Negative Declaration, Mitigated
 Negative Declaration, Environmental
 Impact Report)

Date of Notice of Preparation __/__/____
 (expected /
 actual)

Date of Draft ND/MND/EIR

___/___/_____
(expected /
actual)

Date Notice of Determination filed at
OPR or County Clerk

___/___/_____
(expected /
actual)

Governmental Approvals

Please describe each of the Governmental Approvals to be obtained by Seller and the status of each:

Status Summary

e.g., dates of application / hearing / notice / etc. (note whether dates are anticipated or actual); major activities (indicate whether planned, in progress and/or completed); primary reasons for possible delay, etc.

Agency / Approval

6.3 Governmental Approval activities recently performed

Please list all Governmental Approval activities that occurred since the previous report.

6.4 Governmental Approval activities expected during the current month

Please list all Governmental Approval activities that are expected to occur during the current month.

6.5 Governmental Approval Notices received from EPC Contractor

Please attach to this Monthly Progress Report copies of any notices related to Governmental Approval activities received since the previous report, whether from EPC Contractor or directly from Governmental Authorities.

7. Site Control

7.1 Table of Site Control schedule

If not obtained prior to execution of the Agreement, please provide the schedule Seller intends to follow to obtain control of the Site (e.g., purchase, lease).

Activity	Completion Date
	__/__/____ (expected / actual)
	__/__/____ (expected / actual)

7.2 Site Control activities recently performed

Please explain in detail the property acquisition activities that were performed since the previous report.

7.3 Site Control activities expected during the current month

Please explain in detail the site control activities that are expected to be performed during the current month.

8. Land Rights for the Company-Owned Interconnection Facilities

8.1 Table of Land Rights schedule for Company-Owned Interconnection Facilities

If not obtained prior to execution of the Agreement, please provide the schedule Seller intends to follow to obtain control of the Land for the Company-Owned Interconnection Facilities (e.g., purchase, lease).

Activity	Completion Date
	__/__/____ (expected / actual)
	__/__/____ (expected / actual)

8.2 Land Control activities recently performed

Please explain in detail the property acquisition activities that were performed since the previous report.

8.3 Land Control activities expected during the current month

Please explain in detail the Land control activities that are expected to be performed during the current month.

9. Design and Engineering

9.1 Design and engineering schedule

Please provide the name of the EPC Contractor, the date of execution of the EPC Contract, and the date of issuance of a full notice to proceed (or equivalent).

Please list all major design and engineering activities, both planned and completed, to be performed by Seller and the EPC Contractor.

Name of EPC Contractor / Subcontractor	Activity	Completion Date
		___/___/_____ (expected / actual)
		___/___/_____ (expected / actual)

9.2 Design and engineering activities recently performed

Please explain in detail the design and engineering activities that were performed since the previous report.

9.3 Design and engineering activities expected during the current month

Please explain in detail the design and engineering activities that are expected to be performed during the current month.

10. Major Equipment Procurement

10.1 Major equipment to be procured

Please list all major equipment to be procured by Seller or the EPC Contractor:

Equipment Description	Manufacturer	Delivery Date (indicate whether expected or actual)	Installation Date (indicate whether expected or actual)
		__/__/____ (expected / actual)	__/__/____ (expected / actual)
		__/__/____ (expected / actual)	__/__/____ (expected / actual)

Equipment Description	No. Ordered	No. Made	No. On-Site	No. Installed	No. Tested

10.2 Major Equipment procurement activities recently performed

Please explain in detail the major equipment procurement activities that were performed since the previous report.

10.3 Major Equipment procurement activities expected during the current month

Please explain in detail the major equipment procurement activities that are expected to be performed during the current month.

11. Construction

11.1 Construction activities

Please list all major construction activities, both planned and completed, to be performed by Seller or the EPC Contractor.

Activity	EPC Contractor / Subcontractor	Completion Date
		___/___/_____ (expected / actual)
		___/___/_____ (expected / actual)

11.2 Construction activities recently performed

Please explain in detail the construction activities that were performed since the previous report.

11.3 Construction activities expected during the current month

Please explain in detail the construction activities are expected to be performed during the current month.

11.4 EPC Contractor Monthly Construction Progress Report

Please attach a copy of the Monthly Progress Reports received since the previous report from the EPC Contractor pursuant to the construction contract between Seller and EPC Contractor, certified by the EPC Contractor as being true and correct as of the date issued.

12. Interconnection

12.1 Interconnection activities

Please list all major interconnection activities, both planned and completed, to be performed by Seller or the EPC Contractor.

Activity	Name of EPC Contractor / Subcontractor	Completion Date
		___/___/_____ (expected / actual)
		___/___/_____ (expected / actual)

12.2 Interconnection activities recently performed

Please explain in detail the interconnection activities that were performed since the previous report.

12.3 Interconnection activities expected during the current month

Please explain in detail the interconnection activities that are expected to be performed during the current month.

13. Startup Testing and Commissioning

13.1 Startup testing and commissioning activities

Please list all major startup testing and commissioning activities, both planned and completed, to be performed by Seller or the EPC Contractor.

Activity	Name of EPC Contractor / Subcontractor	Completion Date
		___/___/_____ (expected / actual)
		___/___/_____ (expected / actual)

13.2 Startup testing and commissioning activities recently performed

Please explain in detail the startup testing and commissioning activities that were performed since the previous report.

13.3 Startup testing and commissioning activities expected during the current month

Please explain in detail the startup testing and commissioning activities that are expected to be performed during the current month.

14. Safety and Health Reports

14.1 Accidents

Please describe all Facility-related accidents reported since the previous report.

14.2 Work stoppages

Please describe all Facility-related work stoppages from that occurred since the previous report.

Please describe the effect of work stoppages on the Facility schedule.

15. Certification

I, _____, on behalf of and as an authorized representative of [_____], do hereby certify that any and all information contained in this Seller's Monthly Progress Report is true and accurate, and reflects, to the best of my knowledge, the current status of the construction of the Facility as of the date specified below.

By: _____

Name: _____

Title: _____

Date: _____

ATTACHMENT T
CALCULATION AND REPORTING OF PRODUCTION-BASED AVAILABILITY
AND DISPUTE RESOLUTION BY INDEPENDENT PBA EVALUATOR

1. Production-Based Availability Overview.
 - (a) General Approach. The availability of the Facility is to be evaluated on the basis of production-based availability rather than time-based availability. Production-based availability shall be evaluated for each WTGS based on (i) the actual production of such WTGS, as measured at such WTGS, during periods when the Facility is fully dispatched and (ii) the calculation of the lost production of such WTGS during periods when the Facility is not Generating due to conditions within Seller's scope of responsibility. The results of such measurements and calculations for each WTGS shall then be aggregated to determine the production-based availability for the Facility as a whole. The details of the foregoing are more fully set forth in Section 2.5 (Facility PBAF; Liquidated Damages; Termination Rights) of this Agreement and in the balance of this Attachment T (Calculation and Reporting of Production-Based Availability and Dispute Resolution by Independent PBA Evaluator). The specific provisions of said Section 2.5 (Facility PBAF; Liquidated Damages; Termination Rights) and the balance of this Attachment T (Calculation and Reporting of Production-Based Availability and Dispute Resolution by Independent PBA Evaluator) shall control in the event of any conflict between such provisions and this Section 1(a) (General Approach).
 - (b) Modified Information Model. The Modified Information Model is set forth below in this Section 1(b) (Modified Information Model) of Attachment T (Calculation and Reporting of Production-Based Availability and Dispute Resolution by Independent PBA Evaluator). The purpose of the Modified Information Model is to facilitate the calculation of production-based availability (and, hence, Facility PBAF) by allocating, for each WTGS, the time that such WTGS is in certain "information categories" and, based upon such allocation of time, to allocate to each such information category the Actual WTGS Production and the Potential Production of such WTGS while in such information category.

MODIFIED INFORMATION MODEL						
Information categories				Priority	Actual WTGS Production Used to Calculate PBAF	Potential Production Included in Lost Production Used to Calculate PBAF
Level 1	Level 2	Level 3	Level 4			
INFORMATION AVAILABLE	OPERATIVE	GENERATING	FULL DISPATCH	1	Yes	No
			PARTIAL DISPATCH	2	No*	No
		NON-GENERATING	TECHNICAL STANDBY	3	N/A	No
			OUT OF ENVIRONMENTAL SPECIFICATION	4	N/A	No
			OUT OF ELECTRICAL SPECIFICATION	5	N/A	No
	COMPANY-ATTRIBUTABLE NON-PERFORMANCE	COMPANY-ATTRIBUTABLE FORCED OUTAGE		6	N/A	No
		SHUTDOWN REQUESTED BY COMPANY		7	N/A	No
	SELLER-ATTRIBUTABLE NON-PERFORMANCE	SELLER-ATTRIBUTABLE NON-GENERATION		8	N/A	Yes
		SHUTDOWN NOT REQUESTED BY COMPANY		9	N/A	Yes
		SCHEDULED MAINTENANCE		10	N/A	Yes
		PLANNED CORRECTIVE ACTION		11	N/A	Yes
		FORCED OUTAGE (exclusive of Company-Attributable Forced Outage)		12	N/A	Yes
	SUSPENDED		13	N/A	Yes	
	FORCE MAJEURE			14	N/A	No
	INFORMATION UNAVAILABLE (exclusive of IU Shutdown)				15	No

Copyright © 2014 IEC, Geneva, Switzerland. Modifications made to original.

* Although Actual WTGS Production during periods of Partial Dispatch shall not be used in the calculation of Facility PBAF, it shall be included in the calculation of the BOP Efficiency Ratio under Section 2.6 (Calculation of BOP Efficiency Ratio) of this Agreement.

2. Defined Terms. When used in this Attachment T (Calculation and Reporting of Production Based Availability and Dispute Resolution by Independent Evaluator of Production-Based Availability) and elsewhere in this Agreement, the following capitalized terms shall have the meanings set forth below:

"Actual WTGS Production": For each WTGS, the total quantity of electrical energy (measured in kilowatt hours) produced by such WTGS over a given time period as measured at such WTGS. For avoidance of doubt, Actual WTGS Production differs from Actual Output in that Actual Output is (i) for the Facility as a whole and (ii) is measured at the revenue meter.

"Applicable Power Curve": For the period commencing on the Commercial Operations Date through the end of the first Contract year, the "Applicable Power Curve" for each WTGS shall be the Manufacturer's Power Curve for such turbine. For the second Contract Year and for each Contract Year thereafter, the "Applicable Power Curve" for each WTGS shall be (i) the Historical Power Curve for such turbine as calculated for such Contract Year or (ii) such other Power Curve as shall be deemed under Section 4(c)(iv) (Determination of Historical Power Curve) of this Attachment T (Calculation and Reporting of Production Based Availability and Dispute Resolution by Independent Evaluator of Production-Based Availability) to be the "Applicable Power Curve" for such turbine for such Contract Year.

"Average Density-Adjusted Wind Speed": For purposes of determining the Potential Production of an WTGS for each 10-minute increment or portion thereof that such WTGS is in IU Shutdown, the average of the Density-Adjusted Wind Speed for the Information Available WTGS(s) over that same 10-minute increment.

"Company-Attributable Forced Outage": Time periods during which the WTGS in question (or the Facility as a whole) is not Generating because it is in Forced Outage due to conditions on the Company System other than the following excluded conditions: (i) Seller-Attributable System Conditions or (ii) conditions that the Facility is required to ride-through under Section 3 (Performance Standards) of Attachment B (Facility Owned by Seller). For avoidance of doubt, the data and calculated values during periods when

either of the two aforementioned excluded conditions are in effect shall be recorded in the Forced Outage information category and not in the Company-Attributable Forced Outage information category.

"Company-Attributable Non-Performance": Time periods during which when the WTGS in question (or the Facility as a whole) is not Generating because the conditions set forth in the definition of one of the two following underlying information categories have been satisfied: (i) Company-Attributable Forced Outage or (ii) Shutdown Requested by Company.

"Density-Adjusted Wind Speed": For each 10-minute increment for each WTGS, the 10-minute averaged wind speed measurement from a calibrated anemometer on top of the nacelle for such turbine as adjusted for temperature and pressure as provided in Section 4(c)(ii) (Calculation of Density-Adjusted Wind Speed) of Attachment T (Calculation and Reporting of Production Based Availability and Dispute Resolution by Independent Evaluator of Production-Based Availability) to this Agreement.

"Excess Energy Conditions": An operating condition on the Company System that may occur when Company has more energy available than is required to meet the load on the Company System at any point in time and the generating assets interconnected with the Company System are operating at or near their minimum levels, taking into consideration factors such as the need to maintain system reliability and stability under changing system conditions and configurations, the need for downward regulating reserves, the terms and conditions of power purchase agreements for base-loaded firm capacity or scheduled energy, and the normal minimum loading levels of such units.

"Facility Actual Production": The sum, over a given time period, of the Actual WTGS Production of all of the Facility's WTGS(s). For purposes of calculating the Facility Actual Production for the calendar month covered by a Monthly PBA Report under Section 6 (PBA Report) of this Attachment T (Calculation and Reporting of Production Based Availability and Dispute Resolution by Independent Evaluator of Production-Based Availability), the time period in question is the calendar month covered by such PBA Report. For purposes of calculating the BOP Efficiency Ratio for a Contract Year, the time period in question is

such Contract Year. For avoidance of doubt, the Facility Actual Production is not the equivalent of the Actual Output because (as defined in this Agreement) the latter is measured at the revenue meter while the Facility Actual Production is the total of the Actual WTGS Production (i.e., the total of the production measured at the turbines).

"Facility Lost Production": The sum, over a given time period, of the Lost Production of all of the Facility's WTGS(s) while in Seller-Attributable Non-Performance as calculated as set forth in Section 4(d) (Calculation of Facility Lost Production for Each WTGS for Periods of Seller-Attributable Non-Performance) of this Attachment T (Calculation and Reporting of Production-Based Availability and Dispute Resolution by Independent PBA Evaluator). For purposes of calculating the Facility Lost Production for the calendar month covered by a Monthly PBA Report under Section 6 (PBA Report) of this Attachment T (Calculation and Reporting of Production Based Availability and Dispute Resolution by Independent Evaluator of Production-Based Availability), the time period in question is the calendar month covered by such PBA Report. For purposes of calculating Facility PBAF for a PBAF LD Period, the time period in question is such PBAF LD Period.

"Facility Full Dispatch Production": The sum, over a given time period, of the Actual WTGS Production of all of the Facility's WTGS(s) when the Facility is in Full Dispatch. For purposes of calculating the Facility Full Dispatch Production for the calendar month covered by a Monthly PBAF Report under Section 6 (PBA Report) of the this Attachment T (Calculation and Reporting of Production-Based Availability and Dispute Resolution by Independent PBA Evaluator), the time period in question is the calendar month covered by such PBA Report. For purposes of calculating the Facility PBAF for a PBAF LD Period, the time period in question is such PBAF LD Period.

"Force Majeure": An event that satisfies the requirements of Section 21.1 (Definition of Force Majeure), Section 21.2 (Events That Could Qualify as Force Majeure) and Section 21.3 (Exclusions From Force Majeure).

"Forced Outage": An unplanned disabling of the generating capability of some or all of the Facility caused by factors such as automatic or programmed protective trips and trips

due to equipment malfunction, and which terminates when Company determines according to Good Engineering and Operating Practices that it is safe to bring the Facility back onto the Company System. For avoidance of doubt, the periods for which data and calculated values shall be recorded in the Forced Outage information category shall exclude periods of Company-Attributable Forced Outage but shall include periods of Forced Outage resulting from: (i) Seller-Attributable System Conditions and (ii) conditions on the Company System that the Facility is required to ride-through under Section 3 (Performance Standards) of Attachment B (Facility Owned by Seller).

"Full Dispatch": The time periods during which the WTGS in question is Generating and the Facility's set point is not less than the Allowed Capacity.

"Generating": The WTGS in question is converting wind energy into electrical energy and/or providing reactive power compensation.

"Historical Power Curve": For each WTGS, the historical power curve for such turbine for the Contract Year in question, as (i) calculated as set forth in Section 4(c)(iv) (Determination of Historical Power Curve) of Attachment T (Calculation and Reporting of Production Based Availability and Dispute Resolution by Independent Evaluator) to this Agreement, (ii) agreed by of the Parties as set forth in Section 7(d) (Submission of HPC Disagreement to Independent PBA Evaluator) of said Attachment T or (iii) decided by the Independent PBA Evaluator as set forth in Section 7(j) (Written Decision of Independent PBA Evaluator) of said Attachment T.

"IEC": The International Electrotechnical Commission and any successor entity.

"IEC Information Model": Shall have the meaning set forth in Section 3(a) (Changes Made to IEC Information Model) of this Attachment T (Calculation and Reporting of Production-Based Availability and Dispute Resolution by Independent PBA Evaluator).

"IEC 61400-12-1": The IEC 61400-12-1 (First edition 2005-12) or, in lieu thereof, any replacement, revision or amendment of IEC 61400-12-1 (First edition 2005-12) issued by IEC that Company and Seller agree in writing, subsequent

to the Execution Date, should apply to this Agreement and the Facility. For avoidance of doubt: (i) in the absence of such a written agreement subsequent to the Execution Date, the First edition 2005-12 of IEC 61400-12-1, as modified as set forth in this Attachment T (Calculation and Reporting of Production-Based Availability and Dispute Resolution by Independent PBA Evaluator) to this Agreement, shall apply to this Agreement and the Facility without giving effect to any replacement, revision, amendment or withdrawal of IEC 61400-12-1 (First edition 2005-12) by IEC during the Term; and (ii) as used in this Agreement, the term "IEC 61400-12-1" includes all Annexes thereto.

"IEC/TS 61400-26-1": The IEC/TS 61400-26-1 (Edition 1.0 2011-11) or, in lieu thereof, any replacement (including but not limited to replacement by an international standard), revision or amendment of IEC/TS 61400-26-1 (Edition 1.0 2011-11) issued by IEC that Company and Seller agree in writing, subsequent to the Execution Date, should apply to this Agreement and the Facility. For avoidance of doubt: (i) in the absence of such a written agreement subsequent to the Execution Date, the Edition 1.0 2011-11 of IEC/TS 61400-26-1, as modified as set forth in this Attachment T (Calculation and Reporting of Production-Based Availability and Dispute Resolution by Independent PBA Evaluator) to this Agreement, shall apply to this Agreement and the Facility without giving effect to any replacement, revision, amendment or withdrawal of IEC/TS 61400-26-1 (Edition 1.0 2011-11) by IEC during the Term; and (ii) as used in this Agreement, the term "IEC/TS 61400-26-1" includes all Annexes thereto.

"IEC/TS 61400-26-2": The IEC/TS 61400-26-2 (Edition 1.0 2014-06) or, in lieu thereof, any replacement (including but not limited to replacement by an international standard), revision or amendment of IEC/TS 61400-26-2 (Edition 1.0 2014-16) issued by IEC that Company and Seller agree in writing, subsequent to the Execution Date, should apply to this Agreement and the Facility. For avoidance of doubt: (i) in the absence of such a written agreement subsequent to the Execution Date, the Edition 1.0 2014-06 of IEC/TS 61400-26-2, as modified as set forth in this Attachment T (Calculation and Reporting of Production-Based Availability and Dispute Resolution by Independent PBA Evaluator) to this Agreement, shall apply to this Agreement and the Facility without giving effect to any replacement, revision, amendment or withdrawal of IEC/TS 61400-26-2

(Edition 1.0 2014-06) by IEC during the Term; and (ii) as used in this Agreement, the term "IEC/TS 61400-26-2" includes all Annexes thereto.

"Information Available": Time periods during which the WTGS in question is not the Information Unavailable category of the Modified Information Model.

"Information Available WTGS": For purposes of determining the Potential Production of a WTGS during the period such WTGS is in IU Shutdown, a WTGS that, at no point during such period, is in either (i) IU Shutdown or (ii) the Information Unavailable category of the Modified Information Model.

"Information Unavailable": Time periods during which at least one of the following two conditions applies to the WTGS in question: (i) reliable production and meteorological information concerning such WTGS is not available to the Company System Operator in real time via SCADA; or (ii) the Seller is unable to automatically log such information to permanent storage. A WTGS leaves the Information Unavailable information category when reliable production and meteorological information concerning such WTGS is both available to the Company System Operator in real time via SCADA and is being automatically logged to permanent storage. For avoidance of doubt:

- Because the availability to the Company System Operator in real time via SCADA of reliable meteorological and production information for each WTGS is necessary in order for Company to effectively optimize the benefits of its right to dispatch the Facility, a WTGS for which reliable information is not available in real time as aforesaid shall, for purposes of calculating Facility PBAF, be included in the Information Unavailable category (or, if the Company had exercised its rights under Section 6.4 (IU Shutdown) of this Agreement, shall be included in IU Shutdown) even if such information has been stored either permanently or on field measuring devices and provided to Company at a later time; and
- For purposes of calculating Facility PBAF, the Information Unavailable category shall not include any WTGS that is, during such period, in IU Shutdown.

"IU Shutdown": For each WTGS, the period during which the Company has directed Seller, pursuant to Section 6.4 (IU Shutdown) of this Agreement, to shutdown such WTGS (or the Facility as a whole) due to the unavailability to the Company System Operator of reliable meteorological and/or production information in real time via SCADA.

"Lost Production": For each WTGS, the Lost Production for such WTGS for periods of Seller-Attributable Non-Performance as derived as set forth in Section 4(d) (Calculation of Lost Production for Each WTGS for Period of Seller-Attributable Non-Performance) of Attachment T (Calculation and Reporting of Production Based Availability and Dispute Resolution by Independent Evaluator of Production-Based Availability) to this Agreement.

"Manufacturer's Power Curve": For each WTGS, the manufacturer's "site specific" reference power curve applicable to such turbine.

"Measured Wind Speed": For each WTGS, the arithmetic mean, over any given period of time, of the wind speed readings from such turbine's nacelle anemometer, taken or sampled every two (2) seconds by the Facility's Monitoring and Communication Equipment, in miles per hour (mph). For calculations under this Agreement based on Measured Wind Speed in m/s, the conversion factor shall be 1 mph = 0.447 m/s.

"Modified Information Model": Shall be as set forth in Section 1(b) (Modified Information Model) of this Attachment T (Calculation and Reporting of Production-Based Availability and Dispute Resolution by Independent PBA Evaluator).

"Non-Generating": Time periods during which the WTGS in question is Operative but not Generating because the conditions set forth in the definition of one of the following underlying information categories has been satisfied: (i) Technical Standby; (ii) Out of Environmental Specification; or (iii) Out of Electrical Specification.

"Operative": Time period during which (i) the WTGS in question is capable of performing the generation function, regardless of the capacity level that can be provided, and (ii) the conditions set forth in the definition of one of

the following underlying information categories have been satisfied: (aa) Generating or (bb) Non-Generating.

"Out of Electrical Specification": Time periods during which the WTGS in question is Operative but not Generating because the electrical conditions at the WTGS terminal are outside design specifications. This may include, but is not limited to, the following aspects:

- voltage;
- frequency;
- phase imbalance.

"Out of Environmental Specification": Time periods during which the WTGS in question is Operative but not Generating because the conditions of the natural environment are outside the design specifications. Natural environmental conditions could include ambient temperature, wind speed, humidity, atmosphere acidity, dust, turbulence, air density, etc.

"Partial Dispatch": Time periods during which the WTGS in question is Generating but the Facility's set point is less than the Allowed Capacity.

"Planned Corrective Action": Time periods during which actions are required to retain, restore, or improve the generating function of the WTGS in question when such actions are not part of Scheduled Maintenance. Planned Corrective Action may include retrofits and upgrades, or required corrective actions identified through condition-based maintenance, inspections, investigations etc., and is intended to account for corrective action where the need is identified prior to any actual failure and early enough to be planned and completed before resulting in a possible Forced Outage.

"Potential Production": For each WTGS, the potential energy production of such WTGS over a given time period based on the Density-Adjusted Wind Speed and the power determination for such Density-Adjusted Wind Speed as determined by the Applicable Power Curve in a manner consistent with Section A.2.2 (Nacelle anemometer and measurement with power curve) of Annex A to IEC/TS 61400-26-2 as modified and/or supplemented in Section 3(a) (Changes Made to IEC Information Model) and Section 4 (Population of Information Categories of Modified Information Model) of Attachment T

(Calculation and Reporting of Production Based Availability and Dispute Resolution by Independent Evaluator of Production-Based Availability) of this Agreement.

"Power Curve": A table of wind speeds and MW at a reference density.

"Power Curve Calculation Data Period": The Power Curve Calculation Data Period shall mean: (i) for the second Contract Year, the one-year period preceding the Power Curve Calculation Date for the second Contract year; (ii) for the third Contract Year, the two-year period preceding the Power Curve Calculation Date for such Contract Year; and (iii) for the third Contract Year and for each Contract Year thereafter, the three-year period prior to the Power Curve Calculation Date for the Contract Year in question.

"Power Curve Calculation Date": The first Day of the second Contract Year and thereafter on the first Day of each subsequent Contract Year or, for any Contract Year, such other date as the Parties shall agree in writing for such Contract Year.

"Scheduled Maintenance": Time periods during which scheduled maintenance actions affecting the WTGS in question are performed at the Facility.

"Seller-Attributable Non-Generation": Time periods during which the WTGS in question (or the Facility as a whole) is not dispatched or is derated or shutdown (or the Facility is disconnected) because of any of the following:

- (i) The Facility's failure to comply with any of the Performance Standards, Good Engineering and Operating Practices, Government Approvals, applicable Laws or Seller's other obligations under this Agreement;
- (ii) Seller-Attributable System Conditions;
- (iii) Conditions at or on either side of the Point of Interconnection arising from the acts or omissions of Seller or any vendor, materialmen, customer or supplier of Seller, unless such acts or omissions are themselves excused by reasons of Force Majeure pursuant to Article 21 (Force Majeure) of this Agreement;

- (iv) A disconnection initiated by the Company pursuant to Article 9 (Personnel and System Safety) of this Agreement);
- (v) Such WTGS (or the Facility as a whole) is in IU Shutdown;
- (vi) The Company has decided that it is inadvisable for such WTGS (or the Facility as a whole) to continue normal operations without a further Control System Acceptance Test as provided in Section 7(a) (Testing Requirements) of Attachment B (Facility Owned by Seller); or
- (vii) The Facility is deemed to be in Seller-Attributable Non-Generation status under Section 1(b) (iii) (H) (iv) of Attachment B (Facility Owned by Seller).

"Seller-Attributable Non-Performance": Time periods during which the WTGS in question is not Generating because the conditions set forth in the definition of one of the following underlying information categories have been satisfied: (i) Seller-Attributable Non-Generation; (ii) Shutdown Not Requested by Company; (iii) Scheduled Maintenance; (iv) Planned Corrective Action; (v) Forced Outage (exclusive of Company Attributable Forced Outage); or (vi) Suspended.

"Seller-Attributable System Conditions": Conditions on the Company System:

- (i) that result from either (aa) the Facility's generation and delivery of electric power to the Company System or (bb) any condition arising from the acts or omissions of Seller or any vendor, materialmen, customer or supplier or Seller, unless such acts or omissions are themselves excused by reasons of Force Majeure pursuant to Article 21 (Force Majeure) of this Agreement; and
- (ii) that Company reasonably determines to either (xx) be inconsistent with Good Engineering and Operating Practices on the Company System or (yy) jeopardize the safety, reliability or stability of the Company System.

For avoidance of doubt, the Company's inability to dispatch the Facility due to the existence of Excess Energy Conditions on the Company System shall not constitute Seller-Attributable System Conditions.

"Shutdown Not Requested by Company": Time periods during which the WTGS in question is not Generating because it has been stopped by a demand or constraint other than a Shutdown Requested by Company. The Shutdown Not Requested by Company includes, but is not limited to, shutdowns resulting from:

- Compliance with applicable Laws and/or Governmental Approvals;
- Actions of Governmental Authorities.

"Shutdown Requested by Company ": Time periods during which the WTGS in question is not Generating because it has been stopped by a request from the Company System Operator for reasons other than Seller-Attributable Non-Generation.

"Suspended": Time periods during which activities in Scheduled Maintenance, Planned Corrective Action and Forced Outage have to be interrupted or cannot be initiated due to conditions which compromise personal safety or equipment integrity. The Suspended information category includes, but is not limited to:

- access limitations to the Site;
- severe weather conditions;
- reduction-of-risk activities initiated because of, e.g., brush fire;
- orders of a Governmental Authority for suspension of the work because of personal safety;
- Site working conditions are not met.

"Technical Standby": Time periods during which the WTGS in question is Operative but not Generating and is actively performing tasks required for generation. This may include without limitation:

- safety loop test;
- component and system self-testing;
- cable unwinding/untwisting;

- heating up or cooling down after a period of "Out of Environmental Specification" due to temperature;
- ramp-up time - from a command to completion of command;
- dry out time after WTGS stop/pause with high humidity.

3. Modified Information Model Background.

(a) Changes Made to IEC Information Model. The Modified Information Model was developed from the information model described in IEC/TS 61400-26-1 and IEC/TS 61400-26-2 (the "IEC Information Model"). However, the Parties acknowledge that, although the IEC Information Model provides a useful starting point for the calculation of production-based availability, the IEC Information Model does not appropriately reflect, among other things, (i) the responsibility of Seller for the Facility and the acts or omissions of certain third parties with whom Seller interacts and (ii) the responsibility of Company for conditions on the Company System (other than Seller-Attributable System Conditions and conditions that the Facility is required to ride-through under this Agreement). Accordingly, the Modified Information Model includes the following modifications to the IEC Information Model:

- (i) Full Performance and Partial Performance: The "Full Performance" and "Partial Performance" information categories of the IEC Information Model are replaced by the new information categories in the Modified Information Model of "Full Dispatch" and "Partial Dispatch."
- (ii) Requested Shutdown: The "Requested Shutdown" information category of the IEC Information Model is replaced by two new categories in the Modified Information Model: "Shutdown Requested by Company" (which is an underlying information category of the new "Company-Attributable Non-Performance" information category of the Modified Information Model) and "Shutdown Not Requested by Company" (which is an underlying information category of the new "Seller-Attributable Non-Performance" information category of the Modified Information Model).

- (iii) Non-Operative: The "Non-Operative" information category of the IEC Information Model is replaced by two new information categories: "Company-Attributable Non-Performance" and "Seller-Attributable Non-Performance." Unlike the "Non-Operative" information category of the IEC Information Model (a pre-requisite of which is that the WTGS not be capable "of performing the generating function"), the lack of such capability is not a pre-requisite to inclusion in either the "Company-Attributable Non-Performance" or the "Seller-Attributable Non-Performance" information categories of the Modified Information Model.
- (iv) Company-Attributable Non-Performance. A new information category of "Company-Attributable Non-Performance" is established with two new underlying information categories: "Company-Attributable Forced Outage" and "Shutdown Requested by Company."
- (v) Seller-Attributable Non-Performance. A new information category of "Seller-Attributable Non-Performance" is established with two new underlying information categories ("Seller-Attributable Non-Generation" and "Shutdown Not Requested by Company") and the four following underlying information categories retained from the IEC Information Model, one of which ("Forced Outage") has been modified: "Scheduled Maintenance," "Planned Corrective Action," "Forced Outage (exclusive of Company-Attributable Forced Outage)" and "Suspended." For avoidance of doubt, a WTGS that is in IU Shutdown is included in the "Seller-Attributable Non-Generation" information category.
- (vi) Forced Outage. The "Forced Outage" information category of the IEC Information Model is modified to exclude periods of Company-Attributable Forced Outage.
- (vii) Information Unavailable. The "Information Unavailable" category of the IEC Information Model is modified to exclude WTGS(s) that are that are in IU Shutdown. A WTGS that is in IU

Shutdown is included in the "Seller-Attributable Non-Generation" information category.

- (b) Priority of Information Categories. The information categories are exclusive. In situations in which the conditions for allocating a time period to more than one information category are satisfied at the same time, the time period in question shall be allocated to the information category with the highest priority. The order of priorities is specified in the Modified Information Model, with 15 being the highest priority. The following are examples of allocating a period of time pursuant to the priorities set forth in the Modified Information Model:
- (i) if scheduled maintenance is conducted at the Facility during a period of calm winds, the period of time in question shall be allocated to the Scheduled Maintenance information category even if the calmness of wind would be sufficient to satisfy the conditions for the Out of Environmental Specification information category. In such case, the calmness of wind would be a factor in calculating the Potential Production (and hence the Lost Production) to be allocated to the Scheduled Maintenance information category during the period in question;
 - (ii) if conditions on the Company System sufficient to constitute a Company-Attributable Forced Outage occur during a period of scheduled maintenance at the Facility, the period of time in question shall be allocated to the Scheduled Maintenance information category; and
 - (iii) if the Facility is not dispatched because of the Facility's failure to comply with Performance Standards, the period of time in question shall be allocated to the Seller-Attributable Non-Generation information category even if the WTGS(s) in question were "capable of performing the generation function" within the meaning of the Operative information category.

4. Population of Information Categories of Modified Information Model and Calculation of Values.

- (a) Allocation of Time. It is the intent of the Modified Information Model to account for each second of every Day and the provisions of this Attachment T (Calculation and Reporting of Production Based Availability and Dispute Resolution by Independent Evaluator of Production-Based Availability), shall be construed so as to include each second of every Day in one of the categories of the Modified Information Model. In the event a particular period of time does not satisfy the express conditions for any of the information categories set forth in the definitions in Section 2 (Defined Terms), such period of time shall be allocated to the information category that comes closest to describing the time period in question. Without limitation to the generality of the preceding two sentences:
- (i) time shall be allocated to the Full Dispatch or Partial Dispatch information categories, as applicable, for periods during which the WTGS in question satisfies the conditions set forth in the definitions of "Full Dispatch" and "Partial Dispatch," respectively, in Section 2 (Defined Terms) of this Attachment T (Calculation and Reporting of Production-Based Availability and Dispute Resolution by Independent PBA Evaluator);
 - (ii) time shall be allocated to the Technical Standby, Out of Environmental Specification or Out of Electrical Specification information categories, as applicable, for periods during which the WTGS in question satisfies the conditions set forth in the definitions of "Technical Standby," "Out of Environmental Specification" and "Out of Electrical Specification," respectively, in Section 2 (Defined Terms) of this Attachment T (Calculation and Reporting of Production-Based Availability and Dispute Resolution by Independent PBA Evaluator);
 - (iii) time shall be allocated to the Company-Attributable Forced Outage information category for periods during which the WTGS in question satisfies conditions set forth in the definition of "Company-Attributable Forced Outage" in Section 2 (Defined Terms) of this Attachment T (Calculation Reporting of Production-Based

Availability and Dispute Resolution by Independent PBA Evaluator);

- (iv) time shall be allocated to the Shutdown Requested by Company information category for periods during which the WTGS in question satisfies the conditions set forth in the definition of "Shutdown Requested by Company" set forth in Section 2 (Defined Terms) of this Attachment T (Calculation Reporting of Production-Based Availability and Dispute Resolution by Independent PBA Evaluator);
- (v) time shall be allocated to the Seller-Attributable Non-Generation information category for periods during which the WTGS in question satisfies the conditions set forth in the definition of "Seller-Attributable Non-Generation" set forth in Section 2 (Defined Terms) of this Attachment T (Calculation and Reporting of Production-Based Availability and Dispute Resolution by Independent PBA Evaluator);
- (vi) time shall be allocated to the Shutdown Not Requested by Company information category for periods during which the WTGS in question satisfies the conditions set forth in the definition of "Shutdown Not Requested by Company" set forth in Section 2 (Defined Terms) of this Attachment T (Calculation Reporting of Production-Based Availability and Dispute Resolution by Independent PBA Evaluator);
- (vii) time shall be allocated to the Scheduled Maintenance, Planned Corrective Action, Forced Outage (exclusive of Company-Attributable Force Outage) and Suspended information categories, as applicable, for periods during which the WTGS in question satisfies the conditions set forth in the definition of "Scheduled Maintenance," "Planned Corrective Action," "Forced Outage" and "Suspended," respectively, in Section 2 (Defined Terms) of this Attachment T (Calculation Reporting of Production-Based Availability and Dispute Resolution by Independent PBA Evaluator);

- (viii) time shall be allocated to the Force Majeure information category for periods during which the WTGS in question satisfies the conditions set forth in the definition of "Force Majeure" in Section 2 (Defined Terms) of this Attachment T (Calculation Reporting of Production-Based Availability and Dispute Resolution by Independent PBA Evaluator);
 - (ix) time shall be allocated to the Information Unavailable (exclusive of IU Shutdown) category for periods during which the WTGS in question satisfies the conditions set forth in the definition of "Information Unavailable" in Section 2 (Defined Terms) of this Attachment T (Calculation Reporting of Production-Based Availability and Dispute Resolution by Independent PBA Evaluator); and
 - (x) time shall be allocated to IU Shutdown (which, by definition, is part of the Seller-Attributable Non-Generation information category) for periods during which the WTGS in question satisfies the conditions set forth in the definitions of "IU Shutdown" in Section 2 (Defined Terms) of this Attachment T (Calculation and Reporting of Production-Based Availability and Dispute Resolution by Independent PBA Evaluator).
- (b) Allocation of Production and Potential Production to Time Periods.
- (i) Allocation of Production During Full Dispatch. During periods of Full Dispatch, all of the Actual WTGS Production shall be allocated to the Full Dispatch information category and shall be included in the Facility Full Dispatch Production that is used to calculate Facility PBAF for the PBAF LD Period in question.
 - (ii) Allocation of Production During Partial Dispatch. Actual WTGS Production during periods of Partial Dispatch shall be allocated to the Partial Dispatch information category and shall be disregarded for purposes of calculating Facility PBAF, although Actual WTGS Production during periods of Partial Dispatch shall be added to

Facility Full Dispatch Production for purposes of calculating the BOP Efficiency Ratio under Section 2.6 (Calculation of BOP Efficiency Ratio) of this Agreement.

(iii) Allocation of Potential Production During Periods of Seller-Attributable Non-Performance.

Potential Production (as calculated as provided in Section 4(c)(i) (Calculation of Potential Production) of this Attachment T (Calculation and Reporting of Production Based Availability and Dispute Resolution by Independent Evaluator of Production-Based Availability)) during periods of Seller-Attributable Non-Performance shall be allocated to the Seller-Attributable Non-Performance information category.

(c) Calculation of Potential Production for Each WTGS for Periods of Seller-Attributable Non-Performance.

(i) Calculation of Potential Production.

(aa) Calculation of Potential Production of Each WTGS That is in IU Shutdown. The Potential Production for each WTGS during periods when such WTGS is in IU Shutdown shall be based on (i) the Average Density-Adjusted Wind Speed of the Information Available WTGS(s) for each 10-minute increment or portion thereof during the period of such IU Shutdown and (ii) the Applicable Power Curve for the WTGS that is in IU Shutdown.

(bb) Calculation of Potential Production for Each WTGS That is Not In IU Shutdown. The Potential Production during periods when a WTGS is in the Seller-Attributable Non-Performance information category for reasons other than IU Shutdown shall be calculated based on (i) the Density-Adjusted Wind Speed for such turbine for each 10-minute increment or portion thereof that such turbine is in the Seller-Attributable Non-Performance information category and (ii) the 10-minute averaged power determination from the Applicable Power Curve for such turbine in a manner consistent with Section

A.2.2 (Nacelle anemometer and measurement with power curve) of Annex A to IEC/TS 61400-26-2, as modified and supplemented by Section 4(c)(iii) (Calculation of Applicable Power Curve) and Section 4(c)(iv) (Determination of Historical Power Curve) of this Attachment T (Calculation and Reporting of Production Based Availability and Dispute Resolution by Independent Evaluator of Production-Based Availability).

- (ii) Calculation of Density-Adjusted Wind Speed. For purposes of calculating Density-Adjusted Wind Speed for each WTGS other than a WTGS in IU Shutdown, the 10-minute averaged wind speed measurement from the nacelle anemometer for such turbine shall be adjusted for the 10-minute averaged ambient air temperature and the 10-minute averaged ambient air pressure (both as measured by the field measurement devices located at approximately "hub height" on the Facility's MMTs) by calculating the Density-Adjusted Wind Speed for such turbine for each 10-minute increment as follows:

$$V_n = V_{obs} \left(\frac{\rho_{calc}}{\rho_0} \right)^{1/3}$$

where:

- V_n = Density-Adjusted Wind Speed [m/s];
 V_{obs} = Measured Wind Speed (10-minute averaged) [m/s]
 ρ_0 = 1.225 kg/m³
 ρ_{calc} = Calculated Air Density (10-minute averaged) [kg/m³]

$$= \frac{B_{obs}}{R_0 * T_{K_{obs}}}$$

where:

B_{obs} = Measured Ambient Air Pressure (10-minute averaged) [Pa]

R_0 = specific gas constant for dry air (287.057 J/kg*K)

$T_{K_{obs}}$ = Measured Ambient Air Temperature (10-minute averaged) [K]

For unit conversion purposes:

$$1 \text{ Pa} = 0.01 \text{ mbar}$$

$$T_{Kelvin} = T_{Celsius} + 273.15$$

The foregoing formulae are based on the formulae found at Section 8.1 of IEC 61400-12-1.

- (iii) Determination of Applicable Power Curve. For purposes of calculating Potential Production, the Applicable Power Curve for each WTGS shall be: (i) for the period commencing on the Commercial Operations Date through the end of the first Contract Year, the Manufacturer's Power Curve for such turbine; and (ii) for the second Contract Year and for each Contract Year thereafter: (aa) the Historical Power Curve for such turbine as determined as provided in this Attachment T (Calculation and Reporting of Production Based Availability and Dispute Resolution by Independent PBA Evaluator of Production-Based Availability); (bb) in the event an Historical Power Curve cannot be determined as aforesaid for such turbine for the Contract Year in question, the Historical Power Curve for the most recent Contract Year for which a Historical Power Curve was determined for such turbine; or (cc) if no Historical Power Curve has ever been determined for such turbine, the Manufacturer's Power Curve for such turbine.
- (iv) Determination of Historical Power Curve. Commencing with the second Contract Year and for each Contract year thereafter, the Historical Power Curve for each WTGS shall be calculated by Seller using the following data from the Power Curve Calculation Data Period applicable to the Contract Year in question: (aa) the Density-Adjusted Wind Speed (for avoidance of doubt, the only referenced air density shall be the ISO standard atmosphere for sea level air density of 1.225 kg/m³ as set forth in Section 4(c)(ii) (Calculation of Density-Adjusted Wind Speed) of this Attachment T), (bb) the 10-minute averaged Measured Wind Speed and (cc) the 10-minute averaged power output of such WTGS. The data set used for calculating the Historical Power Curve as of each Power Curve Calculation Date shall include only Measured Wind Speed and power output measurements during periods of Full Dispatch when the necessary information is available from the

Monitoring and Communication Equipment. The Historical Power Curve shall be calculated using (i) 0.5 m/s wind bins ranging from 1 *m/s* below the manufacturer's specified cut-in-wind speed to, at least, 1.5 times the wind speed specified by the manufacturer as associated with 85% of the rated power of the WTGS and (ii) the 10-minute averaged power output for each wind speed bin. The data set used to calculate the Historical Power Curve should include a minimum of 180 hours of sampled data from periods of Full Dispatch during the applicable Power Curve Calculation Data Period, where each wind bin includes the minimum of 30 minutes of sampled data. If the aforementioned required minimums of sampled data are not available, Seller and Company may agree in writing upon a smaller data set to calculate the Historical Power Curve for the Contract Year in question. If the Parties are unable to agree on such smaller data set, the Historical Power Curve for such turbine for the most recent Contract Year for which a Historical Power Curve has been calculated shall be deemed to be the Applicable Power Curve for such turbine for the Contract Year in question. If there is no previously calculated Historical Power Curve for such turbine, the Manufacturer's Power Curve for such turbine shall be deemed to be the Applicable Power Curve for such turbine for the Contract Year in question. Except as necessary to satisfy the foregoing requirements of this Section 4(c)(iv) (Determination of Historical Power Curve) of this Attachment T (Calculation and Reporting of Production Based Availability and Dispute Resolution by Independent Evaluator of Production-Based Availability), the Historical Power Curve shall be calculated in a manner consistent with Clause 8.1 and Clause 8.2 of IEC 61400-12-1. Upon Seller's calculation of the Historical Power Curve for each WTGS for each Contract Year beginning with the second Contract Year as provided in this Section 4(c)(iv) (Determination of Historical Power Curve), Seller shall provide written notice to Company of such Historical Power Curve(s).

- (d) Calculation of Lost Production for Each WTGS for Periods of Seller-Attributable Non-Performance. Once Potential Production for each WTGS for the time periods that such WTGS is in the Seller-Attributable Non-Performance information category has been calculated and allocated as provided in Section 3(b)(iii) (Allocation of Potential Production During Periods of Seller-Attributable Non-Performance) and Section 4(c) (Calculation of Potential Production for Each WTGS for Periods of Seller-Attributable Non-Performance) of this Attachment T (Calculation and Reporting of Production Based Availability and Dispute Resolution by Independent Evaluator of Production-Based Availability), the Lost Production for such WTGS shall be calculated as follows:
- (i) for periods during which such WTGS is in IU Shutdown, the Lost Production allocated to such WTGS while in IU Shutdown shall equal the Potential Production allocated to such WTGS while in IU Shutdown;
 - (ii) for periods during which such WTGS is included in the Seller-Attributable Non-Generation information category, the Lost Production for such WTGS shall equal (aa) the Lost Production (if any) allocated to such WTGS while in IU Shutdown pursuant to the foregoing Section 4(d)(i) of this Attachment T (Calculation and Reporting of Productions Based Availability and Dispute Resolution by Independent PBA Evaluator) plus (bb) any other Potential Production allocated to such WTGS while in the Seller-Attributable Non-Generation information category for reasons other than IU Shutdown; and
 - (iii) for all other underlying information categories of the Seller-Attributable Non-performance information category, Lost Production shall equal the Potential Production allocated to such category.

For avoidance of doubt, for periods during which a WTGS is in any of the following information categories, Lost Production shall not be calculated for such WTGS while in such category because Potential Production was not calculated for such WTGS while in

such category under Section 4(c) (Calculation of Potential Production for Each WTGS for Periods of Seller-Attributable Non-Performance) of this Attachment T (Calculation and Reporting of Productions Based Availability and Dispute Resolution by Independent PBA Evaluator): (aa) any of the underlying information categories of the "Operative" information category; (bb) either of the underlying information categories of the "Company-Attributable Non-Performance" information category; (cc) the "Force Majeure" information category; and (dd) the Information Unavailable category (which, by definition, excludes WTGS(s) that are in IU Shutdown).

- (e) Calculation of Facility Lost Production. For purposes of calculating the Facility PBAF for each PBAF LD Period, Facility Lost Production is the sum of the Lost Production allocated to any of the underlying information categories of the "Seller-Attributable Non-Performance" information category for each WTGS for each month of such PBAF LD Period.
5. Calculation of Facility PBAF. Facility PBAF shall be calculated as provided in Section 2.5(a) (Calculation of Facility PBAF) of this Agreement.
6. PBA Report. Commencing with the month during which the Commercial Operations Date is achieved, and for each calendar month thereafter during the Term, Seller shall provide to Company, in Excel, Lotus or such other format as Company may require, a PBA Report in the form set forth below populated with data and calculated values for both the calendar month in question and the PBAF LD Period ending with such calendar month, which Report shall include (i) for each WTGS for the calendar month in question, measured Actual WTGS Production and the calculated Potential Production and resulting Lost Production for such calendar month and (ii) Seller's calculation of the Facility PBAF for the PBAF LD Period ending with such calendar month. Seller shall deliver such PBA Report to Company by the fifth (5th) Business Day following the close of the calendar month in question. Seller shall deliver the PBA Report electronically to the address provided by the Company. Company shall have the right to verify all data set forth in the PBA Report by inspecting measurement instruments and reviewing Facility operating records. Upon Company's request, Seller shall promptly provide to Company

any additional data and supporting documentation necessary for Company to audit and verify any matters in the PBA Report.

Monthly PBA Report

Table A
Monthly Production

Summarized Monthly SCADA Production Data		A	B
		Actual WTGS Production While in Full Dispatch (kWh)	Actual WTGS Production While in Partial Dispatch (kWh)
Data Start	1/1/2019		
Data End	1/31/2019		
# of Seconds in Calendar Month			
WTGS XXX			
WTGS XXX			
WTGS XXX			
WTGS XXX			
WTGS XXX			
WTGS XXX			
WTGS XXX			
WTGS XXX			
WTGS XXX			
WTGS XXX			
WTGS XXX			
WTGS XXX			
WTGS XXX			
WTGS XXX			
WTGS XXX			

Monthly PBA Report (contd.)

Table B
(One Table B for Each WTGS)
Turbine **xxx**: Events of Seller-Attributable Non-Performance

A	B	C	D	E	F	G	H
Seller-Attributable Event No.	Event Start Date	Event Start Time	Event End Date	Event End Time	Number of Seconds for Event	Lost Production for Event (Equals Potential Production for Event)	Reason for Seller-Attributable Event
1							
2							
3							
4							
5							
6							

Turbine **xxx**: Total Lost Production for such Turbine during Events of Seller-Attributable Non-Performance in month covered by Monthly PBA Report (Sum of Column G of Table B for Turbine in Question):

Turbine **xxx**: Total Actual WTGS Production for such Turbine While Facility is in Full Dispatch in month covered by Monthly PBA Report (From Applicable Row of Column A of Table A)

Monthly PBA Report (contd.)
Totals for Month and for PBAF LD Period

MONTHLY DATA FOR USE IN CALCULATING FACILITY PBAF

Facility Full Dispatch Production (i.e., Total Actual WTGS Production While Facility is in Full Dispatch) for month covered by Monthly PBA Report (Sum of Column A of Table A): _____

Facility Lost Production for all events of Seller-Attributable Non-Performance for month covered by Monthly Report (Sum of Column G of all Table Bs): _____

MONTHLY DATA FOR USE IN CALCULATING BOP EFFICIENCY RATIO

Facility Actual Production (i.e., Total of Actual WTGS Production in Both Full Dispatch and Partial Dispatch) for month covered by Monthly PBA Report (Sum of Columns A and B of Table A): _____

PERFORMANCE METRICS FOR PBAF LD PERIOD (i.e., 12-month period ending with Month covered by Monthly PBA Report)

Total Facility Full Dispatch Production for the 11 months prior to month covered by Monthly PBA Report: _____

Total Facility Lost Production for all events of Seller-Attributable Non-Performance for the 11 months prior to month covered by Monthly PBA Report: _____

Facility PBAF for PBAF LD Period per following formula: _____

$$\text{Facility PBAF} = 1 - \frac{\text{Facility Lost Production}}{\text{Facility Full Dispatch Production} + \text{Facility Lost Production}}$$

Amount (if any) by which Facility PBAF for PBAF LD Period falls below PBAF Benchmark: _____

Liquidated Damages (if any) assessed for falling below PBAF Benchmark: _____

Lump Sum Payment due for month covered by Monthly PBA Report: _____

7. Disagreements Concerning Historical Power Curve, Production-Based Availability and BOP Benchmark.
- (a) Notice of Disagreement With Determination of Historical Power Curve. Within ten (10) Business Days after each Power Curve Calculation Date, Seller shall provide written notice to Company of the Historical Power Curve for each WTGS for such Contract Year as provided in Section 4(c)(iv) (Determination of Historical Power Curve) of this Attachment T (Calculation and Reporting of Production-Based Availability and Dispute Resolution by Independent PBA Evaluator). Within thirty (30) Days after Company's receipt of Seller's written notice of the Historical Power Curve for each WTGS, Company shall provide written notice to Seller of any disagreement with any such determination ("HPC Disagreement"). Together with any such notice of disagreement ("Notice of HPC Disagreement"), the Company shall include its own calculations and other support of its position. If Company fails to provide a Notice of HPC Disagreement within said 30-Day period, the Historical Power Curve for each WTGS for such Contract Year as calculated by the Seller pursuant to the aforesaid Section 4(c)(iv) (Determination of Historical Power Curve) shall be deemed to be accepted by Company and shall no longer be subject to dispute by Company or Seller.
- (b) Notice of Disagreement With PBA Report. Within five (5) Business Days following the close of the calendar month in question, Seller shall provide to Company the PBA Report for such calendar month and for the PBAF LD Period ending with such calendar month as provided in Section 6 (PBA Report) of this Attachment T (Calculation Reporting of Production-Based Availability and Dispute Resolution by Independent PBA Evaluator). Within ten (10) Business Days after Company's receipt of a PBA Report, Company shall provide written notice to Seller of any disagreement with any matter concerning such PBA Report, including (i) for the calendar month in question, the data on Actual WTGS Production and the calculation of Potential Production for each WTGS in any of the underlying information categories of the Seller-Attributable Non-Generation information category and the resultant Lost Production for such WTGS and (ii) Seller's calculation of the Facility PBAF for the PBAF LD Period ending with such calendar month ("PBA

Disagreement"). Together with any such notice of disagreement ("Notice of PBA Disagreement"), the Company shall include its own calculations and other support for its position. If Company fails to provide a Notice of PBA Disagreement within said 10-Business Day period, the PBA Report provided by Seller shall be deemed to be accepted by Company and shall no longer be subject to dispute by Company or Seller.

- (c) Notice of Disagreement With BOP Benchmark Determination. If Seller disagrees with either (i) the BOP Benchmark derived by Company from, as applicable, the IE Energy Assessment Report, the Initial OEPR or any Subsequent OEPR or (ii) Company's claim that it is unable to reasonably derive a BOP Benchmark from, as applicable, the IE Energy Assessment Report or any written clarification issued by an OEPR Evaluator pursuant to either Section 2.6(b)(ii) (Commencing With the Third Contract Year) or Section 2.6(b)(iii) (Commencing With the First Subsequent OEPR and Thereafter) of this Agreement, Seller shall, within thirty (30) Days after receipt of Company's written notice of the BOP Benchmark pursuant to Section 2.6(b) (Determination of BOP Benchmark) of this Agreement, provide written notice to Company of Seller's disagreement with either (i) the BOP Benchmark derived by Company as aforesaid or (ii) Company's claim that it is unable to reasonably derive a BOP Benchmark ("BOP Benchmark Disagreement"). Together with such notice of disagreement ("Notice of BOP Benchmark Disagreement"), the Seller shall include its own calculation and other support for its position. If Seller fails to provide such notice within such 30-Day period, the BOP Benchmark designated in Company's written notice shall be deemed to be accepted by Seller and shall no longer be subject to dispute by Company or Seller. For avoidance of doubt, if Company claims that it is unable to reasonably derive a BOP Benchmark from, as applicable, the IE Energy Assessment Report or any written clarification issued by an OEPR Evaluator, Company shall be deemed to have designated a BOP Benchmark of **97%**.
- (d) Submission of HPC Disagreement to Independent PBA Evaluator. Upon issuance of a Notice of HPC Disagreement, the Parties shall review the Historical Power Curve(s) in question together with such Notice of HPC Disagreement and attempt to resolve such HPC Disagreement. If the Parties are able to agree on a

resolution of such HPC Disagreement, the resulting Historical Power Curve for each WTGS for such Contract Year shall be set forth in a writing executed by both Parties, following which such Historical Power Curve for such WTGS for such Contract Year shall be deemed to be the Historical Power Curve for such WTGS for such Contract Year under this Agreement and shall no longer be subject to dispute by either Party. If the Parties are unable to agree on a written resolution of such HPC Disagreement within thirty (30) Days after Company's issuance of such notice of disagreement, either Party may submit the unresolved HPC Disagreement to an Independent PBA Evaluator for resolution. If, within five (5) Business Days following the expiration of said 30-Day period, neither Party has submitted such HPC Disagreement to an Independent PBA Evaluator, the Historical Power Curve for each WTGS for such Contract Year as calculated by Seller pursuant to Section 4(c)(iv) (Determination of Historical Power Curve) of this Attachment T (Calculation and Reporting of Production-Based Availability and Dispute Resolution by Independent PBA Evaluator) shall be deemed to be accepted by Company and shall no longer be subject to dispute by Company or Seller.

- (e) Submission of PBA Disagreement to Independent PBA Evaluator. Upon issuance of a Notice of PBA Disagreement, the Parties shall review the contents of the PBA Report(s) together with such Notice of PBA Disagreement and attempt to resolve such PBA Disagreement. If the Parties are able to agree on a resolution of any PBA Disagreement, the resulting corrected PBAF Report(s) in question shall be set forth in a writing executed by both Parties, following which (i) such corrected PBA Reports shall no longer be subject to dispute by either Party and (ii) to the extent such resolution of such PBA Disagreement affects future PBA Reports, such future PBA Reports shall be prepared in a manner consistent with such resolution. If the Parties are unable to resolve such PBA Disagreement within thirty (30) Days after Company's issuance of such notice of PBA Disagreement, either Party may, within five (5) Business Days after the end of such 30-Day period, submit the unresolved PBA Disagreement to an Independent PBA Evaluator for resolution. Notwithstanding anything to the contrary in this Section 7(e) (Submission of PBA Disagreement to Independent PBA Evaluator), once the Historical

Power Curve has been (i) deemed to be accepted by Company pursuant to Section 7(a) (Notice of Disagreement With Determination of Historical Power Curve) of this Attachment T (Calculation and Reporting of Production-Based Availability and Dispute Resolution by Independent PBA Evaluator), (ii) resolved pursuant to Section 7(d) (Submission of HPC Disagreement to Independent PBA), or (iii) resolved pursuant to Section 7(j) (Written Decision of Independent PBA Evaluator) of this Attachment T (Calculation and Reporting of Production-Based Availability and Dispute Resolution by Independent PBA Evaluator), the issue of the Historical Power Curve may not be reopened by either Party in the guise of a PBA Disagreement.

- (f) Submission of BOP Benchmark Disagreement to Independent PBA Evaluator. Upon issuance of a notice of BOP Benchmark Disagreement, the Parties shall review, as applicable, the IE Energy Assessment Report, the Initial OEPR and any written clarification thereof issued by the OEPR Evaluator who prepared the Initial OEPR, and any Subsequent OEPR and any written clarification thereof issued by the OEPR Evaluator who prepared the Subsequent OEPR, together with such notice of BOP Benchmark Disagreement, and attempt to resolve such BOP Benchmark Disagreement. If the Parties are able to agree on a resolution of any BOP Benchmark Disagreement, the resulting corrected BOP Benchmark shall be set forth in writing executed by both Parties, following which such corrected BOP Benchmark shall constitute the BOP Benchmark for the Contract Years in question. If the Parties are unable to resolve such BOP Benchmark Disagreement within thirty (30) Days after Seller's issuance of such notice of BOP Benchmark Disagreement, either Party may, within five (5) Business Days after the end of such 30-Day period, submit the unresolved BOP Benchmark Disagreement to an Independent PBA Evaluator for resolution. The authority of the Independent PBA shall be limited to deciding the following issues:
- i. If Company derived a BOP Benchmark from, as applicable, the IE Energy Assessment, the Initial OEPR and/or any written clarification issued by the OEPR Evaluator who prepared the Initial OEPR or a Subsequent OEPR and/or any written clarification issued by the

OEPR Evaluator who prepared such Subsequent OEPR, the authority of the Independent PBA Evaluator shall be limited to deciding:

(aa) Is the BOP Benchmark derived by Company reasonably supported by the document from which it was derived as aforesaid?; and

(bb) If not, what is the BOP Benchmark that is best supported by such document?

ii. If Company claimed that is was unable to reasonably derive a BOP Benchmark from, as applicable, the IE Energy Assessment, the Initial OEPR and/or written clarification issued by the OEPR Evaluator who prepared the Initial OEPR or a Subsequent OEPR and/or any written clarification issued by the OEPR Evaluator who prepared such Subsequent OEPR, the authority of the Independent PBA Evaluator shall be limited to deciding:

(aa) Was Company correct in claiming that a BOP Benchmark cannot be reasonably derived from the document in question?; and

(bb) If Company was not correct, what is the BOP Benchmark that is best supported by such document?

For avoidance of doubt, because **97%** is the BOP Benchmark that shall apply to any Contract Year for which a BOP Benchmark cannot be reasonably be derived from the applicable document as aforesaid, the Independent PBA Evaluator shall not have the authority to resolve a BOP Benchmark Dispute by performing an independent evaluation of the Facility to estimate, among other things, BOP electrical losses, in order to arrive at an independent determination of BOP efficiency.

(g) Appointment of Independent PBA Evaluator. If either Party decides to submit an unresolved HPC

Disagreement, unresolved PBA Disagreement or an unresolved BOP Benchmark Disagreement to an Independent PBA Evaluator, it shall provide written notice to that effect (the "Submission Notice") to the other Party, which notice shall designate which of the engineering firms on the OEPR Consultants List is to act as the Independent PBA Evaluator for purposes of resolving such dispute; provided, however, for purposes of facilitating consistency in the resolution of PBA Disagreements, all PBA Disagreements arising out of any one or more of the twelve (12) PBA Reports issued for a given Contract Year shall be submitted to the same Independent PBA Evaluator unless such Independent PBA Evaluator declines to accept any such submission(s). A Submission Notice must be provided within whichever of the following time periods is applicable:

- (i) For any HPC Disagreement, within the 5-Business Day period provided in Section 7(d) (Submission of HPC Disagreement to Independent PBA Evaluator);
- (ii) for any PBA Disagreement, within the 5-Business Day period provided in Section 7(e) (Submission of PBA Disagreement to Independent PBA Evaluator); and
- (iii) for any BOP Benchmark Disagreement, within the 5-Business Day period provided in Section 7(f) (Submission of BOP Benchmark Disagreement to Independent PBA Evaluator).

The Parties shall each pay fifty percent (50%) of the fees and expenses charged by the Independent PBA Evaluator.

- (h) Eligibility for Appointment as Independent PBA Evaluator. Both Parties agree that the engineering firms listed in Section 4(h) of Attachment U (Calculation and Adjustment of Net Energy Potential) are fully qualified to serve as Independent PBA Evaluator. Prior to the end of any Contract Year, either Party may remove a particular consultant from the OEPR Consultants List by giving written notice of such removal to the other Party, which removal (i) will have effect as of January 31st of the immediately following Contract Year but (ii) will not divest such

Independent PBA Evaluator of its authority to decide any disagreements submitted to such Independent PBA Evaluator on or before such January 31st. However, neither Party may remove a name or names from the OEPR Consultants List without approval of the other Party if such removal would leave the list without any names. Proposed additions to the OEPR Consultants List shall automatically become effective thirty (30) Days after notice is received by the other Party unless written objection is made by such other Party within said thirty (30) Day period. By written agreement between the Parties, a new name or names may be added to the OEPR Consultants List at any time.

- (i) Participation of Parties. Promptly following the issuance of a Submission Notice as provided in Section 7(g) (Appointment of Independent PBA Evaluator) of this Attachment T (Calculation and Reporting of Production-Based Availability and Dispute Resolution by Independent PBA Evaluator), Seller and Company shall provide the Independent PBA Evaluator which such data as they consider to be material to the resolution of the disputed issue(s). Seller and Company shall also provide such additional data and information as the Independent PBA Evaluator may reasonably request. The Parties shall assist the Independent PBA Evaluator throughout the process of resolving such dispute, including making key personnel and records available to the Independent PBA Evaluator, but neither Party shall be entitled to participate in any meetings with personnel of the other Party or review of the other Party's records. However, the Independent PBA Evaluator will have the right to conduct meetings, hearing or oral arguments in which both Parties are represented.
- (j) Written Decision of Independent PBA Evaluator. The terms of engagement with the Independent PBA Evaluator shall require the Independent PBA Evaluator to issue its written decision resolving the disputed issues submitted to it within the applicable time period set forth below, which time periods are subject to any tolling that may be applicable pursuant to Section 7(k) (Sequence to Resolving Inter-related Disagreements) of this Attachment T (Calculation and Reporting of Production-Based Availability and Dispute Resolution by Independent PBA Evaluator):

- (i) as measured from the issuance of the Submission Notice: (aa) for a HPC Disagreement, thirty (30) Days; (bb) for a PBA Disagreement, ninety (90) Days; and (cc) for a BOP Benchmark Disagreement, thirty (30) Days; or
- (ii) such other time period as the Parties may agree in writing.

Unless otherwise agreed by the Parties in writing: (i) for a HPC Disagreement, the written decision of the Independent PBA Evaluator shall set forth the Historical Power Curve for each WTGS in question for the Contract Year in question; (ii) for a PBA Disagreement, the written decision of the Independent PBA Evaluator shall set forth (aa) for the calendar month in question, the correct data as determined by such Independent PBA Evaluator for Actual WTGS Production while in Full Dispatch and Actual WTGS Production While in Partial Dispatch for each WTGS that was in dispute and the correct calculation as determined by such Independent PBA Evaluator for any Potential Production and resulting Lost Production that was in dispute and (bb) for the PBAF LD Period ending with the calendar month in question, the Facility PBAF for such PBAF LD Period as determined by such Independent PBA Evaluator if such Facility PBAF was in dispute; and (iii) for a BOP Benchmark Disagreement, the written decision shall: (aa) confirm that the BOP Benchmark derived by the Company was reasonably derived and state that such percentage constitutes the BOP Benchmark; or (bb) confirm the Company's conclusion that it is unable to reasonably derive a BOP Benchmark and state that **97%** is the BOP Benchmark; or (cc) disagree with the Company's conclusion that it is unable to reasonably derive a BOP Benchmark, state the percentage that is the best-supported BOP Benchmark, and state that such percentage constitutes the BOP Benchmark.

(k) Sequence for Resolving Interrelated Disagreements.

- (i) If a HPC Disagreement is unresolved at the time a PBA Disagreement is submitted to an Independent PBA Evaluator pursuant to Section 7(g) (Appointment of Independent PBA Evaluator) of this Attachment T

(Calculation and Reporting of Production-Based Availability and Dispute Resolution by PBA Evaluator), and the resolution of such HPC Disagreement is necessary to the resolution of such PBA Disagreement, the time period for an Independent PBA Evaluator to issue its written decision resolving such PBA Disagreement shall be tolled until the resolution of such HPC Disagreement pursuant to either Section 7(d) (Submission of HPC Disagreement to Independent PBA Evaluator) or Section 7(j) (Written Decision of Independent PBA Evaluator) of this Attachment T (Calculation and Reporting of Production-Based Availability and Dispute Resolution by Independent PBA Evaluator).

- (ii) If at the time a PBA Disagreement is submitted to an Independent PBA Evaluator pursuant to Section 7(g) (Appointment of Independent PBA Evaluator) of this Attachment T (Calculation and Reporting of Production-Based Availability and Dispute Resolution by Independent PBA Evaluator) there are one or more other unresolved PBA Disagreements concerning calendar months that fall within the PBAF LD Period in question that are pending before a different Independent PBA Evaluator, and the resolution of such other PBA Disagreement(s) is necessary to the resolution of the PBA Disagreement that has been newly submitted to a new Independent PBA Evaluator as aforesaid, the time period for such new Independent PBA Evaluator to issue its written decision resolving such newly submitted PBA Disagreement shall be tolled until the resolution of such pending PBA Disagreement(s). For avoidance of doubt, it is the intent of the Parties that disagreements over data and calculations concerning production-based availability for a given calendar month shall (i) not be

subject to resolution twice and (ii) once resolved, shall not be reopened.

- (1) Final, Conclusive and Binding. The Parties acknowledge the inherent uncertainty in calculating Production-Based Availability, the Historical Power Curve and the BOP Benchmark, and hereby assume the risk of such uncertainty and waive any right to dispute the qualification of the person or entity appointed as the Independent PBA Evaluator pursuant to Section 7(g) (Appointment of Independent PBA Evaluator) of this Attachment T (Calculation and Reporting of Production-Based Availability and Dispute Resolution by Independent PBA Evaluator) and/or the appropriateness of the methodology used by Independent PBA Evaluator in resolving such HPC Disagreement, PBA Disagreement or BOP Benchmark Disagreement. Without limitation to the generality of the preceding sentence, the decision of the Independent PBA Evaluator as to each HPC Disagreement, PBA Disagreement and BOP Benchmark Disagreement submitted to an Independent PBA Evaluator shall be final, conclusive and binding upon Company and Seller and shall not be subject to further dispute under Article 28 (Dispute Resolution) of the Agreement.
8. Periodic Review of Method of Calculating and Reporting Production-Based Availability. At least once per Contract Year, Company shall review the method of calculating and reporting Production-Based Availability under this Agreement method to determine if other variables should be incorporated into the Facility PBAF calculation.
9. Future Changes in Reporting Requirements. Seller shall reasonably cooperate with any Company requested revisions to the PBA Report to include additional data that may be necessary from time to time to enable Company to comply with any new reporting requirements directed by the PUC or otherwise imposed under applicable Laws.

DRAFTING NOTE: IN RESPONSE TO COMMENTS RECEIVED FROM STAKEHOLDERS ON THE AVAILABILITY FACTOR CALCULATION IN THE PV PPA, THE COMPANY EXPRESSED ITS WILLINGNESS TO DISCUSS CLARIFICATIONS TO THOSE PROVISIONS SO LONG AS SUCH CLARIFICATIONS ARE CONSISTENT WITH (1) THE CONCEPT THAT THE IPP IS GENERALLY RESPONSIBLE FOR THE AVAILABILITY OF ITS FACILITY AND (2) THE PROVISIONS ARE CONSISTENT ACROSS ALL OF THE COMPANY'S RDG PV

PPAs. COMPANY IS WILLING TO DISCUSS CLARIFICATIONS TO THE PBAF CALCULATION IN ITS RDG WIND PPAs, SUBJECT TO THOSE SAME TWO CONDITIONS. IN PARTICULAR, COMPANY IS CONSIDERING THE APPROPRIATENESS OF INCLUDING BOTH THE PRODUCTION AND THE LOST OUTPUT FROM PARTIAL DISPATCH SCENARIOS IN THE PBAF CALCULATION.

ATTACHMENT U
CALCULATION AND ADJUSTMENT OF NET ENERGY POTENTIAL

1. Net Energy Potential.

(a) Net Energy Potential and the Intent of the Parties. The essence of this Agreement is that Company is paying to Seller a Lump Sum Payment in exchange for Company's right to dispatch, subject to Renewable Resource Variability, the Facility's Net Energy Potential. Under this Agreement, "Net Energy Potential": (i) constitutes an estimated single number with a P-Value of 95 for annual Net Energy that could be produced by the Facility based on the estimated long-term monthly and annual total of such production over a period of ten years; (ii) is subject to adjustment from time to time as provided in this Attachment U (Calculation and Adjustment of Net Energy Potential); and (iii) as so adjusted, provides a basis for calculating and adjusting the Lump Sum Payment, as provided in Section 3 (Calculation of Lump Sum Payment) of Attachment J (Company Payments for Energy and Dispatchability) to this Agreement. It is the intent of the Parties that the estimate of Net Energy Potential, as calculated and adjusted as foresaid, should reflect the following risk allocation between the Parties under this Agreement:

(i) Seller has assumed the risk of downward adjustment to the Net Energy Potential (and hence the Lump Sum Payment) to account for any of the following circumstances:

(aa) if the Renewable Resource Baseline (as estimated on the basis of the typical meteorological year as derived from the Site's measured meteorological data) is lower than Seller had assumed when it submitted its **[Response to RFP]**;

(bb) if the as-built design and construction of the Facility is not as efficient in generating electrical energy and delivering such electric energy to the Point of Interconnection as Seller had assumed when it submitted its **[Response to RFP]**; and

- (cc) if the Facility's level of operational efficiency is below the standard of comparable facilities;
- (ii) Company has assumed the risk of the following (i.e., the following are to be disregarded for purposes of estimating Net Energy Potential (and hence the Lump Sum Payment)):
 - (aa) Renewable Resource Variability; and
 - (bb) the possibility that, at any given moment, Company does not need to dispatch any or all of the electric energy that the Facility is then capable of generating and delivering to the Point of Interconnection.

The foregoing is not intended as an exhaustive list of the risks assumed by either Party under this Agreement or as a limitation on the circumstances that an OEPR Evaluator, in its professional judgment, may decide to take into account in preparing its OEPR under Section 5(f) (Terms of Engagement) of this Attachment U (Calculation and Adjustment of Net Energy Potential).

- (b) NEP RFP Projection. In its response to RFP, the Seller projected that the Facility would have a Net Energy Potential (as defined in this Agreement) of MWh [REDACTED], and Company relied on Seller's NEP RFP Projection in deciding to contract with Seller in lieu of other developers. Among the fundamentals of the bargain evidenced in this Agreement is that there will be consequences to Seller if (i) the IE Energy Assessment does not support the NEP RFP Projection and/or (ii) the operational performance of the Facility indicates a Net Energy Potential that is below the applicable thresholds set forth in this Attachment U (Calculation and Adjustment of Net Energy Potential).
- (c) NEP IE Estimate and Company-Designated NEP Estimate. The Seller shall require the Facility Lender to provide Company with a copy of the IE Energy Assessment Report. Notwithstanding any other provision of this Agreement to the contrary, Company shall have no obligation to co-operate with the Facility Lender or execute any documents in connection with the Financing Documents unless (i) Company has received a copy of the IE Energy Assessment Report and (ii) the Facility Lender represents to Company

that the IE Energy Assessment Report is the latest energy assessment prepared for the Facility Lender as part of the Facility Lender's due diligence leading up to the Facility Lender's legally binding commitment to provide a specific amount of financing for the Project as evidenced by the Facility Lender's execution of the Financing Documents. If the two conditions set forth in the preceding sentence are not satisfied, or if the IE Energy Assessment Report fails to provide a NEP IE Estimate that is consistent with the requirements of this Agreement, Company shall have the option, exercisable by written notice to Seller issued no later than **[30]** Days, or such longer period as the Parties may agree in writing, following the first to occur of Company's receipt of (i) the IE Energy Assessment Report or (ii) notice that Company will not be provided with a copy of the IE Energy Assessment Report, to (aa) designate such Company-Designated NEP Estimate as Company, in its sole discretion, determines to be reasonable in light of the information then available to Company or (bb) declare this Agreement null and void. In connection with Company's decision as to whether to designate a Company-Designated NEP Estimate, Company shall have the right to require Seller to pay for an energy assessment to be performed by an independent engineer selected by Company. In such case, the aforesaid 30-Day period for Company's decision to designate a Company-Designated NEP Estimate or to declare this Agreement null and void shall be tolled for the time necessary to prepare such assessment. If Company fails, within the aforesaid 30-Day period as such period may be tolled as provided in the preceding sentence, to either designate a Company-Designated NEP Estimate or to declare this Agreement null and void, the NEP RFP Projection shall constitute the First NEP Benchmark, unless the Parties agree in writing on a lower First NEP Benchmark.

- (d) NEP IE Estimate, Liquidated Damages and Seller's Null and Void Right. If the NEP IE Estimate is higher than the NEP RFP Projection, the NEP RFP Projection shall constitute the First NEP Benchmark. In any other case, Seller shall have the option to declare this Agreement null and void by written notice to Company as follows:
- (i) if (aa) the NEP IE Estimate is lower than the NEP RFP Projection and (bb) Seller issues its null and void notice to Company not later than **[30]** Days after issuance of the IE Energy Assessment Report; or

- (ii) if (aa) Company exercises its right to designate a Company-Designated NEP Estimate under Section 1(c) of this Attachment U (Calculation and Adjustment of Net Energy Potential), (bb) such Company-Designated NEP Estimate is lower than the NEP RFP Projection, and (cc) Seller issues its null and void notice to Company not later than **[30]** Days after Company's notice of the Company-Designated NEP Estimate.

If Seller fails to declare this Agreement null and void under the conditions set forth in either clause (i) or clause (ii) above, then: (x) the NEP IE Estimate or the Company-Designated NEP Estimate, as applicable, shall thereafter constitute the First NEP Benchmark and (y) Seller shall, within five (5) Business Days following the expiration of the applicable 30-Day period for the issuance of Seller's null and void notice, pay liquidated damages equal to **[\$10]** for every MWh by which the NEP RFP Projection exceeds the First NEP Benchmark.

- 2. Initial OEPR. Following the first Day of the calendar month following the calendar month during which there occurs the second anniversary of the Commercial Operations Date, the Initial OEPR shall be prepared pursuant to the process set forth in Section 4 (Preparation of OEPR) of this Attachment U (Calculation and Adjustment of Net Energy Potential) and the Initial NEP OEPR Estimate shall be as set forth in or derived from the Initial OEPR, as more fully set forth in Section 4(e) (Terms of Engagement) of this Attachment U (Calculation and Adjustment of Net Energy Potential). If the Initial NEP OEPR Estimate differs from the First NEP Benchmark, the Lump Sum Payment shall be recalculated and adjusted as provided in Section 3.ii (Lump Sum Payment During Second Benchmark Period) of Attachment J (Company Payments for Energy and Dispatchability) to this Agreement.

(iii) Subsequent OEPRs.

- (a) Required Subsequent OEPR. If Seller makes any changes to the Facility that involve (i) replacing any step-up transformer(s) or (ii) making any other changes (e.g., changing the characteristics of the Facility equipment or the specifications used in the IRS) that Company reasonably determines require an updated IRS, then Seller shall also be required to have a subsequent OEPR prepared as of the first Day of the calendar month following the second anniversary of the date such change to the Facility was completed.

- (b) Voluntary Subsequent OEPR. Without limitation to the generality of Section 3(a) (Required Subsequent OEPR) of this Attachment U (Calculation and Adjustment of Net Energy Potential), if the Seller makes any changes to the Facility (e.g., replacing original equipment) that does not trigger a required Subsequent OEPR but which changes Seller has reasonable grounds to believe will improve the Facility's Net Energy Potential, Seller shall have a one-time option, exercisable by written notice to Company issued not less than [120] Days prior to the Applicable NEP Verification Date, of having a subsequent OEPR prepared as of a date no sooner than 24 months following completion of the then most recent OEPR.
- (c) Subsequent OEPR and Adjustment to Lump Sum Payment. If the Subsequent NEP OEPR Estimate differs from the Most Recent Prior NEP Benchmark, the Lump Sum Payment shall be recalculated and adjusted as provided in Section 3.iii (Lump Sum Payment Following Second Benchmark Period) of Attachment J (Company Payment for Energy and Dispatchability) to this Agreement.
4. Preparation of OEPR. The following provisions apply to the Initial OEPR and any Subsequent OEPR:
- (a) Selection of OEPR Evaluator. No later than [90] Days prior to the Applicable NEP Verification Date, Company shall select from the engineering firms listed on the OEPR Consultants List an independent engineer (the "OEPR Evaluator") to prepare an operational energy production report ("OEPR").
- (b) Eligibility for Appointment as OEPR Evaluator. Both Parties agree that the engineering firms listed in Section 4(h) of this Attachment U (Calculation and Adjustment of Net Energy Potential) are fully qualified to prepare the OEPR. Prior to the end of any Contract Year, either Party may remove a particular consultant from the OEPR Consultants List by giving written notice of such removal to the other Party, which removal (i) will have effect as of January 31st of the immediately following Contract Year but (ii) will not divest such OEPR Evaluator of its authority to prepare any OEPR for which it was selected on or before such January 31st. However, neither Party may remove a name or names from the OEPR Consultants List without approval of the other Party if such removal would leave the list without any names. Proposed additions to the OEPR Consultants List shall automatically become

effective thirty (30) Days after notice is received by the other Party unless written objection is made by such other Party within said thirty (30) Day period. By written agreement between the Parties, a new name or names may be added to the OEPR Consultants List at any time.

- (c) OEPR Period of Record. It is the intent of the Parties that the OEPR shall be prepared using measured meteorological and production data from the OEPR Period of Record. However, although the OEPR Period of Record is a twelve-month period, the Parties acknowledge that, in certain circumstances (e.g., Force Majeure), there may not be twelve months of data available for the OEPR Period of Record. In such case, (i) it is the intent of the Parties that the OEPR be prepared using such measured meteorological and production data that is available from the OEPR Period of Record and (ii) Parties may, by written agreement, direct the OEPR Evaluator to use such additional data outside of the OEPR Period of Record as the Parties may agree. The preceding sentence does not constitute a limitation on the professional judgment of the OEPR Evaluator as to the appropriateness of using measured meteorological and/or production from outside of the OEPR Period of Record.
- (d) Participation of Parties. Promptly following the Applicable NEP Verification Date, Seller and Company shall provide the OEPR Evaluator which such data from the OEPR Period of Record as they consider to be material to the preparation of the OEPR. Seller and Company shall also provide such additional data and information as the OEPR Evaluator may reasonably request. The Parties shall assist the OEPR Evaluator throughout the process of preparing the OEPR, including making key personnel and records available to the OEPR Evaluator, but neither Party shall be entitled to participate in any meetings with personnel of the other Party or review of the other Party's records. However, the OEPR Evaluator will have the right to conduct meetings, hearing or oral arguments in which both Parties are represented.
- (e) Terms of Engagement. The terms of engagement with the OEPR Evaluator must be acceptable to Company and shall, among other things, require the OEPR to provide (i) an estimated single number with a P-Value of 95 for annual Net Energy that could be produced by the Facility based on the estimated long-term monthly and annual total of such production over a period of ten years and (ii) a BOP

Benchmark for purposes of allowing the Parties to evaluate the BOP Efficiency Ratio as provided in Section 2.6(c) (BOP Benchmark and Liquidated Damages) of this Agreement. The provisions of this Attachment U (Calculation and Adjustment of Net Energy Potential) do not impose a limit on the OEPR's professional judgment as to what other estimates (if any) to include in the OEPR. Without limiting the professional judgment of the OEPR Evaluator in estimating the Net Energy Potential and BOP Benchmark, the following is a general description of how the Parties anticipate that the OEPR Evaluator will proceed:

The purpose of an OEPR is to implement the intent of the Parties as set forth in Section 1(a) (Net Energy Potential and the Intent of the Parties) of this Attachment U (Calculation and Adjustment of Net Energy Potential) by evaluating (i) whether, when the Renewable Resource Baseline (as estimated by the OEPR Evaluator on the basis of the typical meteorological year as derived from the Site's measured meteorological data) is present and all WTGS(s) are in Full Dispatch, the Facility is capable of doing what the Parties expected the Facility to do: i.e., generating and delivering to the Point of Interconnection electric energy in an amount consistent with the then applicable Net Energy Potential of the Facility (i.e., the estimate of Net Energy Potential then being used to calculate the monthly Lump Sum Payment pursuant to Section 3 (Calculation of Lump Sum Payment) of Attachment J (Company Payments for Energy and Dispatchability) to this Agreement); and (ii) if the Facility is not doing what the parties expected in this regard, identifying a new estimated single number with a P-Value of 95 for annual Net Energy that could be generated and delivered by the Facility based on the estimated long-term monthly and annual total of such production over a period of the next ten years.

At a high level, the analysis relies on reported Actual Output (i.e., energy delivered to the Point of Interconnection) during the OEPR Period of Record and reported Facility Actual Production (i.e., energy production measured at the WTGS(s)) during the OEPR Period of Record to estimate Facility performance over a future evaluation period of ten years. The data from the OEPR Period of Record are first quality screened and evaluated. One-time events are assessed and removed from the record where appropriate. Values for potential energy are then calculated from the reported Facility Actual Production by adjusting for 100% availability and undispached energy. Suitable long-term reference data sets are then identified by analyzing the reference for Density-Adjusted Wind Speeds and the normalized values for potential energy production of the WTG(s) over the OEPR Period of Record. Relationships between selected long-term reference wind speed data sets and normalized values for potential energy production of the WTGS(s) are used to calculate long-term values for such on a monthly and annual basis. Finally, estimates of future Facility availability (taking into account anticipated maintenance) and losses (such as blade degradation and BOP losses) are applied to the value for potential energy at the WTGS(s) in order to calculate the Net Energy Potential. For this purpose, no reductions are made for future estimates of energy that Company may choose not to dispatch. If a copy of the IE Energy Assessment Report is available to the OEPR Evaluator, the OEPR Evaluator should review such Report before commencing preparation of the OEPR and evaluate whether it is appropriate for the OEPR Evaluator to take into account any of the work reflected in the IE Energy Assessment Report.

- (f) Timeline and Fees. The terms of engagement with the OEPR Evaluator shall require the OEPR Evaluator to issue the OEPR with 30 Days following the NEP Applicable Verification Date. The Parties shall each pay fifty percent (50%) of the fees and expenses charged by the OEPR Evaluator in connection with the Initial OEPR. Seller shall pay all of the fees and expenses charged by the OEPR Evaluator in connection with any Subsequent OEPR.
- (g) Final, Binding and Conclusive. The Parties acknowledge the inherent uncertainty in estimating the Net Energy Potential and hereby assume the risk of such uncertainty and waive any right to dispute any of the qualification of the person or entity appointed as the OEPR Evaluator pursuant to Section 4(a) (Selection of OEPR Evaluator) and Section 4(b) (Eligibility for Appointment as OEPR Evaluator) of this Attachment U (Calculation and Adjustment of Net Energy Potential) of this Agreement, the appropriateness of the methodology used by OEPR Evaluator in preparing the OEPR, and/or the NEP OEPR Estimate. Without limitation to the generality of the preceding sentence, the determination of the NEP OEPR Estimate in the OEPR or (as more fully set forth in the definition of NEP OEPR Estimate) on the basis of the OEPR, shall be final, conclusive and binding upon Company and Seller and shall not be subject to further dispute under Article 28 (Dispute Resolution) of the Agreement.
- (h) Acceptable Persons and Entities. The following are acceptable as an OEPR Evaluator, subject to such additions or deletions effectuated by the Parties as provided in Section 7(h) (Eligibility for Appointment as Independent PBA Evaluator) of Attachment T (Calculation and Reporting of Production-Based Availability and Dispute Resolution by Independent PBA Evaluator) to this Agreement and Section 4(b) (Eligibility for Appointment as OEPR Evaluator) of this Attachment U (Calculation and Adjustment of Net Energy Potential):

DNV GL

AWS Truepower

ATTACHMENT V
**SUMMARY OF MAINTENANCE AND INSPECTION PERFORMED
IN PRIOR CALENDAR YEAR**

(See Article 5)

DATE WORK ORDER SUBMITTED: 06/28/96

WO#: 11451

EQUIPMENT #: 1CCF-TNK-1

EQUIPMENT DESCRIPTION: AMMONIA STORAGE TANK 1

PROBLEM DESCRIPTION: PURCHASE EMERGENCY ADAPTER FITTINGS FOR
UNLOADING GASPRO TANKS TO STORAGE TANK

WORK PERFORMED: PURCHASED THE NEW ADAPTERS AND VERIFIED THEIR
OPERATION.

COMPLETION DATE: 06/28/96

WORK ORDER COMPLETED BY: AA

-----END OF CURRENT WORK ORDER-----

DATE WORK ORDER SUBMITTED: 05/19/96

WO#: 11136

EQUIPMENT #: 1WSA-BV-12

EQUIPMENT DESCRIPTION: MAKE-UP PI ISOLATION

PROGRAM DESCRIPTION: 'D' MAKE-UP PUMP PI ISOLATION FITTING LEAKING ON
SPOOL SIDE

WORK PERFORMED: REMOVED AND REPLACED FITTINGS AND FLANGES WITH
STAINLESS STEEL. THIS WORK WAS DONE DURING PUMP OVERHAUL ON WO 1374. JH

COMPLETION DATE: 06/28/96

WORK ORDER COMPLETED BY: BB

-----END OF CURRENT WORK ORDER-----

ARTICLE 1 PARALLEL OPERATION..... 3
ARTICLE 2 PURCHASE AND SALE OF ENERGY AND DISPATCHABILITY; RATE
FOR PURCHASE AND SALE; BILLING AND PAYMENT..... 4
ARTICLE 3 FACILITY OWNED AND/OR OPERATED BY SELLER..... 19
ARTICLE 4 COMPANY-OWNED INTERCONNECTION FACILITIES..... 25
ARTICLE 5 MAINTENANCE RECORDS AND SCHEDULING..... 26
ARTICLE 6 FORECASTING..... 30
ARTICLE 7 SELLER PAYMENTS..... 35
ARTICLE 8 COMPANY DISPATCH..... 36
ARTICLE 9 PERSONNEL AND SYSTEM SAFETY..... 38
ARTICLE 10 METERING..... 39
ARTICLE 11 GOVERNMENT APPROVALS, LAND RIGHTS AND COMPLIANCE
WITH LAWS..... 41
ARTICLE 12 TERM OF AGREEMENT AND COMPANY'S OPTION TO PURCHASE
AT END OF TERM..... 42
ARTICLE 13 GUARANTEED PROJECT MILESTONES INCLUDING COMMERCIAL
OPERATIONS..... 48
ARTICLE 14 CREDIT ASSURANCE AND SECURITY..... 53
ARTICLE 15 EVENTS OF DEFAULT..... 57
ARTICLE 16 DAMAGES IN THE EVENT OF TERMINATION BY COMPANY..... 63
ARTICLE 17 INDEMNIFICATION..... 65
ARTICLE 18 INSURANCE..... 69
ARTICLE 19 TRANSFERS, ASSIGNMENTS, AND FACILITY DEBT..... 72
ARTICLE 20 SALE OF ENERGY TO THIRD PARTIES..... 75
ARTICLE 21 FORCE MAJEURE..... 76
ARTICLE 22 WARRANTIES AND REPRESENTATIONS..... 81
ARTICLE 23 PROCESS FOR ADDRESSING REVISIONS TO PERFORMANCE
STANDARDS..... 83
ARTICLE 24 FINANCIAL COMPLIANCE..... 89
ARTICLE 25 GOOD ENGINEERING AND OPERATING PRACTICES..... 94
ARTICLE 26 EQUAL EMPLOYMENT OPPORTUNITY..... 95
ARTICLE 27 SET OFF..... 96
ARTICLE 28 DISPUTE RESOLUTION..... 97
ARTICLE 29 MISCELLANEOUS..... 99
SCHEDULE OF DEFINED TERMS SCHEDULE-1
ATTACHMENT A DESCRIPTION OF GENERATION AND CONVERSION FACILITY... A-1
ATTACHMENT B FACILITY OWNED BY SELLER..... B-1
ATTACHMENT C METHODS AND FORMULAS FOR MEASURING PERFORMANCE
STANDARDS..... C-1
ATTACHMENT D CONSULTANTS LIST..... D-1
ATTACHMENT E SINGLE-LINE DRAWING AND INTERFACE BLOCK DIAGRAM.... E-1
ATTACHMENT F RELAY LIST AND TRIP SCHEME..... F-1
ATTACHMENT G COMPANY-OWNED INTERCONNECTION FACILITIES..... G-1
ATTACHMENT H BILL OF SALE AND ASSIGNMENT..... H-1
ATTACHMENT I ASSIGNMENT OF LEASE AND ASSUMPTION..... I-1
ATTACHMENT J COMPANY PAYMENTS FOR ENERGY AND DISPATCHABILITY.... J-1
ATTACHMENT K GUARANTEED PROJECT MILESTONES..... K-1

ATTACHMENT L REPORTING MILESTONES..... L-1
ATTACHMENT M FORM OF LETTER OF CREDIT..... M-1
ATTACHMENT N ACCEPTANCE TEST GENERAL CRITERIA..... N-1
ATTACHMENT O CONTROL SYSTEM ACCEPTANCE TEST CRITERIA..... O-1
ATTACHMENT P SALE OF FACILITY BY SELLER..... P-1
ATTACHMENT Q [RESERVED]..... Q-1
ATTACHMENT R REQUIRED INSURANCE..... R-1
ATTACHMENT S FORM OF MONTHLY PROGRESS REPORT..... S-1
ATTACHMENT T CALCULATION AND REPORTING OF PRODUCTION BASED
AVAILABILITY AND DISPUTE RESOLUTION BY INDEPENDENT
EVALUATOR.....T-1
ATTACHMENT U CALCULATION AND ADJUSTMENT OF NET ENERGY POTENTIAL..U-1
ATTACHMENT V SUMMARY OF MAINTENANCE & INSPECTION PERFORMED IN
PRIOR CALENDAR YEAR.....V-1

DRAFT REQUEST FOR PROPOSALS
FOR
VARIABLE RENEWABLE DISPATCHABLE GENERATION
ISLAND OF O‘AHU

FEBRUARY 2, 2018

Docket No. 2017-0352

*Appendix D – Code of Conduct
Procedures Manual*



**Hawaiian
Electric**

**HAWAIIAN ELECTRIC COMPANY, INC.
MAUI ELECTRIC COMPANY, LIMITED
HAWAII ELECTRIC LIGHT COMPANY, INC.**

**Code of Conduct Procedures Manual
for the
Competitive Bidding
Program**

I. INTRODUCTION

The Framework for Competitive Bidding (“Framework”) adopted on December 8, 2006, by the Public Utilities Commission of the State of Hawaii (the “Commission”) pursuant to Decision and Order No. 23121 (Docket No. 03-0372, Instituting a Proceeding to Investigate Competitive Bidding for New Generating Capacity in Hawaii), requires that the utility develop and follow a Code of Conduct whenever a utility or its affiliate seeks to advance an energy generation resource proposal in response to a request for proposals (RFP) issued by any of the Hawaiian Electric Companies (Hawaiian Electric Company, Maui Electric Company and Hawaii Electric Light Company) (individually, a “Company” and collectively, the “Companies”). Section III.A.4 of the Framework required the utility to submit to the Commission for review and approval (subject to modification if necessary) a Code of Conduct prior to the commencement of any competitive bid process under the Framework. On June 7, 2007, by letter to the Commission, the Company submitted its form of Code of Conduct for Commission review and approval. By Decision and Order No. 23614 (Docket No. 03-0372), issued August 28, 2007, the Commission approved the Code of Conduct.

This Code of Conduct Procedures Manual has been developed to outline the procedures to be followed and the policies that have been developed surrounding the implementation of the Companies’ competitive bidding process for new generating capacity. This Code of Conduct Procedures Manual has been developed in accordance with the requirements of Section IV.H.9.a(iii) of the Framework and outlines requirements (1), (3) and (4) of such section, namely: (1) the protocols for communicating with proposers, the self-build team, and others; (3) the documentation forms, including logs for any communications with proposers; and (4) other information consistent with the requirements of the solicitation process. Requirement (2) of the section, the evaluation process in detail and the methodologies for undertaking the evaluation process for the RFP are described in detail in Chapter 4 (Evaluation Process and Evaluation Criteria) of the RFP. The bid evaluation process and methodology will consider both

price/system impacts and non-price criteria in accordance with Section IV.E of the Framework and Tariff Rule 19 (See Appendix J (Tariff Rule 19) of the RFP).

The procedures and policies set forth herein have been designed to ensure that the procurement process is undertaken in a fair and equitable manner and that each Proposer is afforded an equal opportunity to participate and compete within the RFP framework.

This Code of Conduct Procedures Manual is intended to serve as a set of rules and guidelines for implementing the Companies' solicitation process and to manage communications between Company personnel and consultants participating in the RFP process. Necessary additions, deletions, and/or changes depending on the circumstances surrounding the RFP and directions from the IO may be required but only as ordered directly by the Commission, or indirectly through the IO after consultation with the Commission.

II. DEFINITIONS

- Affiliate- An "affiliated interest" of the Company as defined in HRS Section 269-19.5(a), specifically: (1) any person/entity holding 10% of more of the shares of the Company, (2) any person/entity holding 10% or more of the ownership interests of an entity holding 10% or more of the shares of the Company; (3) any corporation, 10% of which is owned by a person/entity holding 10% or more the shares of the Company; (4) any person who is an officer or director of the Company; (5) any corporation operating the Company, or providing engineering, accounting, legal, or similar service to the Company, which has 3 or more officers or 3 or more directors in common with the Company; and (6) any corporation which has directors in common with the Company where the number of common directors is more than one-third of the total number of the Company's directors. For the purposes of any RFP where an Affiliate of the Company is presenting a proposal in response to the RFP, such Affiliate and its proposal will be considered and evaluated in the same manner as any other independent Proposer.

- Affiliate Team – Affiliate personnel and outside consultants for the Affiliate responsible for the development of the Affiliate’s response to the RFP.
- Code of Conduct - A written code developed by Hawaiian Electric Company, Inc., Maui Electric Company, Limited and Hawaii Electric Light Company, Inc. (each, a “Company” and collectively, the “Companies”) to ensure the fairness and integrity of the competitive bidding process, in particular where the host utility or its affiliate seeks to advance its own resource proposal in response to an RFP. The Code of Conduct follows the requirements described in Section IV.H.9.c of the Framework and was previously approved by the Commission in Decision & Order No. 23614. Ministerial revisions and clarifications to the Code of Conduct have been proposed by the Companies in the instant Docket.
- Company Executive in Charge – A Company’s executive responsible for ensuring compliance with this Code of Conduct and serving as the point of contact for the Independent Observer for reporting any violations by the Company of the Code of Conduct. For any RFP of the Companies, the Company Executive in Charge shall be the Senior Vice President of Business Development & Strategic Planning. The Company’s Corporate Compliance Officer shall remain responsible for the Companies’ independent code of conduct and may support compliance matters and questions arising with employees, agents and other representatives of the Company, e.g., conflicts of interest, with respect to this Code of Conduct.
- Company RFP Team – The Company personnel and outside consultants responsible for the development of the Company’s RFP and the evaluation of bids submitted in response to the RFP. Within the Company RFP Team, there may be designated certain “core” team members who will be permanent team members of any Company RFP Team. Such “core” members will not have any involvement with the Company Self-Build Team for the subject RFP.
- Company Self-Build Team - The Company personnel and outside consultants responsible for the development of the Company’s self-build response to the RFP. Within the Company Self-Build Team, there may be designated certain

“core” team members who will be permanent team members of any Company Self-Build Team. Such “core” team members will not have any involvement with the Company RFP Team for the subject RFP.

- Confidential Information – Any non-public information developed and provided by the Company (i.e. proprietary system information, etc.) or Proposers during the RFP process (such non-public information may include, for example, the identity of competing Proposers, and their technical, trade or financial information). This term includes any material non-public information regarding the RFP process developed for and used during the competitive bidding solicitation process, such as the evaluation process or criteria. Confidential Information does not include public information, such as information on resources in the Company’s Power Supply Improvement Plan (PSIP) included in its filings with the Commission.
- Director of Energy Procurement - The director of the Division within the Renewable Acquisition Department responsible for directing the resources responsible for the implementation of the competitive bidding process pursuant to the Framework. The Director of Energy Procurement shall be a member of the Company RFP Team. The Director of Energy Procurement will report to the Manager of Renewable Acquisition on the status of the competitive bidding process.
- Eligible Proposer – A Proposer who has met the minimum requirements and threshold requirements in the RFP necessary to remain eligible to compete in the process.
- Energy Contract Manager – The staff position(s) within the Company’s Renewable Acquisition Department responsible for managing the RFP.
- Framework – The Framework for Competitive Bidding contained in Decision & Order No. 23121 issued by Commission on December 8, 2006, to establish rules for competitive bidding in response to a request for proposals when a utility seeks to acquire new generation resources.
- Independent Observer (IO) – The neutral person or entity appointed by the Commission to monitor the utility’s competitive bidding process, and to

advise the utility and Commission on matters arising out of the competitive bidding process, as described in Part III.C of the Framework.

- Manager of Renewable Acquisition – The manager of the Department that will oversee the Company's competitive bidding process. The Manager of Renewable Acquisition shall be a member of the Company RFP Team.
- Proposer – Entity who submits or plans to submit a proposal in response to a Company-issued RFP. An Affiliate of the Company participating in the RFP and submitting a proposal shall be considered a Proposer.

- RFP – A written request for proposals issued by one of the Companies to publicly solicit bids to supply future generating capacity to the Company pursuant to the competitive bidding process established in the Framework.
- Shared Resource – An employee of a Company or consultant to a Company who, because of the scarcity of his/her expertise within the Company, is authorized to communicate and provide information or input to both the Company RFP Team and the Company Self-Build Team and is not a resource dedicated to either team. Shared Resources will not be available as a resource to any Affiliate Team.

- Unassigned Company Resource -- Company employees unassigned to an essential team that may be called upon by the Company RFP Team and/or the Company Self Build Team to assist in meeting limited, *ad hoc* tasks for the RFP or the Self-Build proposal. For example, the RFP team may be unable to evaluate an unforeseen technical specialty included in a bid. In that event, the RFP team would need to request assistance from an employee in the company or a consultant that isn't already assigned to an essential team and possesses the specific expertise. Such personnel are intended to assist the requesting team only in an ad hoc manner, limited in scope and purpose to the particular task required. Unassigned Company Resources, once identified, may become Shared Resources, or if necessary because of the abundance of work performed for a team, may be placed on such team.

III. STATEMENT OF OBJECTIVES

From time to time, the Companies will be proposing to seek power supply proposals for electric generation resources that best meet the needs of the respective Company's system. The timing for issuance of RFPs for each of the systems will be dependent upon the Company's needs identified in the applicable PSIP, the necessary competitive bidding procedures identified in the Framework and upon the timing of the need for capacity for each island. Each of the Companies will undertake a detailed multi-stage review and evaluation process whereby eligible proposals will be selected based upon their ability to most cost-effectively and reliably satisfy the requesting Company's resource requirements. While cost minimization is a major criterion, the Companies will select those resources which, in its opinion, represent the best value to the Companies and its customers regarding economic and technical attributes, limited risk and flexibility for meeting its projected requirements. Consistent with this objective is the Companies' goal of ensuring the competitive benefits of the procurement process while continuing to provide equitable and fair consideration for all proposals. The Companies also intend that the evaluation process will be well-documented so that the results of the evaluation can be fully reviewed by an IO to confirm that all proposals were treated in a fair and consistent manner.

The Code of Conduct and this Manual addresses: (1) communication requirements and procedures associated with the relationship between utility employees (Company RFP Team, Company Self-Build Team, Shared Resources and Unassigned Company Resources); (2) communication requirements and procedures associated with the relationship between the Company RFP Team, the Company Self-Build Team, and Affiliate Team and Proposers; and (3) communication requirements associated with the relationship between Company management and the Company RFP Team. Communications between the Company and any Affiliate Team shall be treated as a communication with an independent third party Proposer. An Affiliate Team shall have no access to any

Shared Resources or Unassigned Company Resources other than such access provided to any other independent third party Proposer.

The Code of Conduct and this Manual also include procedures for the sharing of resources, where necessary and appropriate, by the Company RFP Team and the Company Self-Build Team for the purposes of completing their efforts to effectively administer the RFP or to submit a bid in response to the RFP. The small size of the Companies and limitation of resources will require specialized services, information exchange and sharing of resources in certain limited circumstances. Company personnel and consultants identified as "Shared Resources" or "Unassigned Company Resources" shall be designated by the Companies for this specific purpose. Specific rules shall apply to "Shared Resources" and "Unassigned Company Resources" as described herein and all such communications shall be governed by these rules. It is important to note here that Shared Resources may serve as a resource for either the Company RFP Team or the Company Self-build Team but shall not be a resource to facilitate the communication or the exchange of information between the Company RFP Team and the Company Self-build Team.

IV. ORGANIZATION AND COMMUNICATION RESPONSIBILITIES

This section outlines the RFP organizational structure for the development of the RFP and the Company self-build option and the organization's responsibilities to ensure that communications between Company personnel and consultants working on their respective RFP or self-build projects are conducted in a fair, consistent, and equitable basis so that the Company Self-Build Team does not enjoy any unfair advantage over other Proposers responding to the RFP.

A. Organization

The Company shall identify two separate teams to facilitate the independence and objectivity of the Company resources working on the RFP and ensure an arms-length relationship with the resources working on the Company's self-build

project to avoid any real or perceived inequity in the RFP process. The two essential teams shall be the "Company RFP Team" and the "Company Self-Build Team."

Other limited Company resources, such as select staff from various functional areas of the Company that are in short supply and thus cannot be dedicated solely to either team, may be designated as "Shared Resources" to perform services for the Company RFP Team and Self-Build Team. Shared Resource employees are allowed to carry on with both their RFP (for either the RFP Team and/or the Self-Build Team) and regular functions throughout the resource planning process (including the development of any Company parallel or contingency plan as defined in the Framework), which may require communications with or services performed for the Self-Build Team. Shared Resource employees, however, will not participate in the evaluation and selection process of proposals submitted in response to the RFP. Rules for communications between Shared Resources and the essential teams shall be outlined below.

Company employees unassigned to the RFP may be called upon by the RFP Team, Self-Build Team, or both for help to meet unforeseen tasks. After completing the Code of Conduct training, these "Unassigned Company Resources" are eligible to assist on an ad hoc basis with the requirement that all communications as an Unassigned Company Resource must be memorialized logged in the same manner as communications with Shared Resources. If an Unassigned Company Resource is called upon repeatedly and asked for a substantial amount of assistance by a particular team, the employee should be assigned to such team or evaluated for designation as a Shared Resource.

1. Essential Teams

Company RFP Team. The Company RFP Team, tasked with preparing the RFP and evaluating the responses and bids in response to the RFP, will consist

primarily of Director/Manager-level and other experienced employees together with possible outside consultants, with backgrounds in a number of disciplines necessary to conduct a thorough evaluation of each proposal. The members of the team will be prepared to evaluate proposals on the basis of their price and non-price aspects pertaining to their level of expertise. Members of the Company RFP Team will include professionals with experience in the following areas of expertise: engineering, siting/land use, environmental, transmission planning, fuel procurement, legal, financial planning, system operations, integrated resource planning, generation planning, production cost analysis, and others as needed.

Price and Non-price sub-teams will conduct their sections of the bid evaluation process separately and will not share the results of their evaluation with members of the other sub-team. Each team will submit their evaluation results to an oversight team, which will be responsible for compiling the results of the evaluations and selecting the short-list.

The Energy Contract Manager will be responsible for directing the efforts of the Company RFP Team and for distributing the appropriate sections of the proposal to the appropriate Company RFP Team members when the proposals are received. The Energy Contract Manager will be responsible for maintaining the documentation underlying the evaluation of each proposal as well as all communications with proposers.

The Self-Build Team. The Self-Build Team, tasked with preparing any Company proposal to be submitted by the Company in response to a Company RFP, will consist primarily of Company employees, along with possible outside consultants with backgrounds in a number of disciplines necessary to complete a competitive proposal in response to the Company RFP. The members of the team will include professionals with experience in the following areas of expertise: engineering, siting/land use, environmental, transmission planning, fuel

procurement, legal, financial planning, system operations, integrated resource planning, generation planning, production cost analysis, and others as needed.

Affiliate Team. Any Affiliate Team will be comprised solely of employees and consultants of the Affiliate and no Company employee or consultant shall serve as a member of an Affiliate Team, provided, however, that a consultant may perform services for an Affiliate and the Company so long as appropriate “walls” are established satisfactory to the Company, that ensures that employees of the consultant working for the Affiliate Team do not also perform work for the Company nor communicate with employees of the consultant performing work for the Company, and vice versa. Any consultant of an Affiliate Team assisting with the Affiliate Team’s RFP proposal shall agree to abide by the Code of Conduct and complete the Competitive Bidding Code of Conduct Acknowledgement of Receipt.

2. Other Resources.

Shared Resources. Other limited Company resources, such as select staff from various functional areas of the Company that are in short supply and thus cannot be dedicated solely to either team, may be designated as “Shared Resources” to perform services for the Company RFP Team and Self-Build Team. Shared Resource employees are allowed to carry on with both their RFP (for either the Company RFP Team and/or the Company Self-Build Team but not as a member of such teams) assignments and their regular functions throughout the resource planning process (including the development of any Company parallel or contingency plan as defined in the Framework), which may require communications with or services performed for the Self-Build Team. Shared Resource employees, however, will not participate in the evaluation and selection process of proposals submitted in response to the RFP. Rules for communications between Shared Resources and the essential teams shall be outlined below.

Unassigned Company Resources. Company employees unassigned to either of the essential teams may be called upon by the Company RFP Team, or the Company Self-Build Team for assistance to meet unforeseen tasks. After completing the Code of Conduct training and executing the Competitive Bidding Code of Conduct Acknowledgement of Receipt, these “Unassigned Company Resources” are eligible to assist on an ad hoc basis with the requirement that all communications as an Unassigned Company Resource must be memorialized and logged in the same manner as communications by Shared Resources. If an Unassigned Company Resource is called upon repeatedly and asked for a substantial amount of assistance by a particular team, the employee should be assigned to such team or evaluated for designation as a Shared Resource.

B. Communications Protocols

The Companies have developed policies and procedures governing communication between the Company RFP Team, the Company Self-Build Team, Shared Resources, Unassigned Company Resources, Proposers, the IO and with the Commission regarding RFP design and bid evaluation. Bid information and evaluation data and information shall not be communicated between members of the Company RFP Team, outside parties and other employees within the Companies except to those with a business need to know.

To ensure that the competitive bidding process is fair and unbiased, that all Proposers have access to the same information so that no Proposer has an unfair advantage, and that any Company Self-build and/or Affiliate proposals do not have any unfair competitive advantage or undue preference over third-party bids, the Companies shall follow the Code of Conduct whenever the utility or its Affiliate is seeking to advance a resource proposal as provided in Section IV.H.9.b of the Framework.

Each employee or consultant on the Company RFP Team, Company Self-Build Team and Shared Resources shall read, acknowledge and sign a Competitive Bidding Code of Conduct Acknowledgement of Receipt. Unassigned Company

Resources who may be called upon by the Company RFP Team or Self-Build Team for help to meet unforeseen tasks shall also read, acknowledge and sign a Competitive Bidding Code of Conduct Acknowledgement of Receipt if called upon. Finally, each employee or consultant of an Affiliate intending to submit a proposal in response to a Company-issued RFP shall read, acknowledge and sign a Competitive Bidding Code of Conduct Acknowledgement of Receipt.

The Company issuing the RFP will establish a shared drive on its corporate computer network designed to maintain the bid evaluation documentation and other information associated with the bidding process. Only Company RFP Team members will have access to all the files on the shared drive for the particular RFP.

In cases where staffing and resources are limited or constrained, the Company may identify Shared Resources or those employees eligible to provide information or serve as a resource to both the Company RFP Team and the Company Self-Build Team. Specific rules to log communications with the Company RFP Team or the Company Self-Build Team are described below.

Shared Resources will not have access to the Company's shared drive established for the RFP process which will include the documentation of the bid evaluation results.

1. Communications Between the Company RFP Team and Proposers, including the Company Self-Build Team.

During the RFP process, the Energy Contract Manager shall serve as the primary contact person for all RFP communications with Proposers. This is important from the standpoint of maintaining consistency and confidentiality of information between Proposers and the Company. For documentation and oversight purposes, all communications from Proposers must be submitted to an established website link provided by

the Company (the "Company RFP website"). The IO will monitor all communications through the Company RFP website. To ensure fair and equal access to information, any Company Self-Build Team and/or Affiliate Team shall be considered a Proposer for communication purposes and any request for information from the Company Self-Build Team or Affiliate Team to the Company RFP Team shall be through the Company RFP website.

A single exception to the communication process outlined above shall be instituted for the purpose of facilitating the preliminary exchange of confidential interconnection requirements for any Proposer's bid. For this limited scope, Proposers may communicate with the Company's Interconnection Services Division to discuss preliminary interconnection requirements associated with a Proposer's potential bid. The Director of Interconnection Services for the Company will serve as the primary contact person for all such interconnection communications with a Proposer, provided that all necessary confidentiality and non-disclosure agreements are in place. Employees of the Interconnection Services Division including the Director of Interconnection Services shall be considered "Shared Resources" for purposes of the Code of Conduct and this Procedures Manual and shall be required to adhere to all of its rules and requirements. Under no circumstances shall communicated information from any Proposer be directly or indirectly communicated to the Company RFP Team, the Company Self-Build Team or any Affiliate Team. Interconnection communications will be limited to a Proposer's bid and no more information other than as necessary to facilitate such communications will be permitted. Locations of projects shall be limited to that necessary only to determine the interconnection requirements of such Proposer's project. The IO shall have the right to monitor all such communications in his/her discretion. Company, with input from the IO, reserves the right to share any information that may be generally applicable to all Proposers via the Company RFP website.

Subject to confidentiality obligations, it is the objective of the Code of Conduct that all Proposers, including the Company Self-Build Team and any Affiliate Team, receive access to information released by the Company RFP Team, whether in response to a question from a Proposer or not, at the same time.

The communications process for addressing questions and requests for information from Proposers, and for the Company RFP Team to provide information to Proposers, is provided below:

- a. Other than during Company sponsored conferences, Proposers must submit all questions to the Company RFP website or the designated RFP email address (if the Company RFP website has not been opened yet for the RFP).
- b. Questions will be reviewed and responses will be coordinated with the appropriate functional area within the Company for a response. Every reasonable effort will be made to provide responses in a timely manner.
- c. All responses, including the classification of such response, i.e., whether non-confidential or confidential as described below, will be made available to the IO for monitoring purposes. The IO may choose to comment on any response at its discretion.
- d. Depending on the questions received, responses may involve Confidential Information of the Company and/or Proposers. Release of any Company Confidential Information must be approved in advance by the Company Executive authorized to release the Confidential Information. Any release of Company Confidential Information shall be accompanied by appropriate

confidentiality and non-disclosure agreements, protective orders or other means required to maintain the confidentiality of the Company Confidential Information while still permitting its disclosure under circumstances deemed appropriate by the responsible Company Executive. Other non-Company Confidential Information will not be shared without the prior written consent of the owner of such Confidential Information and the execution of appropriate confidentiality and non-disclosure agreements by all recipients of such Confidential Information. Responses will be categorized as follows:

Non-Confidential Responses: Questions and responses will either be posted directly on the Company RFP website (process-related questions or simple non-substantive information) or a description of the information that can be made available will be posted and Proposers will be instructed to submit a request to the Company via the Company RFP website to receive a copy.

Confidential Responses: Questions and a description or notice of a Confidential Information response will be posted on the Company RFP website and Proposers will be instructed to submit a request to the Company via the Company RFP website to receive instructions on how to access the Confidential Information. The Confidential Information will only be provided to the requestor after receipt of an executed Confidentiality and Non-Disclosure Agreement. Only those who have qualified to submit a bid (i.e. Eligible Proposers) and have executed a Confidentiality and Non-Disclosure Agreement will be considered for receipt of Confidential Information.

Process for Distribution of Confidential Information

Confidential Information provided in response to questions from proposers may be made available only to parties as indicated above via the following:

Confidential Information that is approved for exchanging on a secured access site: (1) Confidential Information may be made available on a secured website with an individual password provided to each approved Proposer. (2) Confidential Information in documents may be transmitted to approved recipients through the Company's secure email system.

Confidential Information that can be made available for inspection only, but cannot be copied: There may be some types of Confidential Information that the Company may consider making available for inspection only with no copies allowed. This type of Confidential Information will be made available on Company premises for inspection only. Proposers will be advised via the Company RFP website to make arrangements with Company staff to view the Confidential Information.

Confidential Information that may not be released. In the event that Proposers submit questions that require responses that the Company feels are not appropriate to provide for reasons which may include, but not be limited to, safety, security, protection of trade secrets or intellectual property rights, Proposers will be advised as such via the Company RFP website.

- e. Prior to and during the RFP, and outside of the Company RFP website protocol, developers may inquire with the Company Interconnection Services Division directly as to the interconnection viability of a proposed project. Contact information will be as follows:

Hawaiian Electric Company, Inc.
Interconnection Services Division
Attention: Director
Email: interconnection.services@hawaiianelectric.com
Telephone: _____

If determined necessary, face-to-face meetings may be scheduled. The IO may, in its discretion, attend and/or monitor such communications and/or meetings.

- f. Once bids are received, the Company may submit information requests to Proposers to clarify their proposals or request additional information. All contacts with Proposers will be through the Company RFP website. If determined necessary, face-to-face meetings may be scheduled. All contacts and information exchanged will be under the oversight of the IO.

2. Communications Between the Companies and the Commission.

The Company's Regulatory Affairs staff will be responsible for initiating communication with the Commission regarding the RFP or the Companies' evaluation process. Regular updates may be provided to the Commission regarding the RFP process if requested.

3. Communications Between the Company RFP Team and the IO.

Communications between the Company RFP Team and the IO will be required for many aspects of the evaluation process. The IO is also required to maintain confidentiality of any Company or Proposer Confidential Information. The IO will coordinate all activities through the Energy Contract Manager and/or the Director of Energy Procurement and/or the Manager of Renewable Acquisition. The IO will be invited to

participate in any meetings or discussions between the Company RFP Team and the Proposers and other communications as noted above. Sufficient notice will be provided whenever possible and teleconference and/or web conference alternatives may be utilized.

In order to provide full access to the IO during the evaluation process, substantive evaluation communications between Company RFP Team members shall be copied to the IO in a contemporaneous manner. Non-substantive and/or administrative communications are not required to be copied to the IO, provided, however, that such communications shall be maintained and reviewable by the IO in his/her discretion.

4. Communications between the Company RFP Team and the Company Self-Build Team

Any communication between the Company RFP Team and the Company Self-Build Team or between the Company RFP Team and any Affiliate Team with respect to the RFP shall be handled no differently than with Proposers and other outside parties. Accordingly, the Self-Build Team and any Affiliate Team will be required to submit any questions or information requests to the Company RFP Team via the Company RFP website and all responses will be provided in the same manner as to other Proposers. Members of the Company RFP Team are prohibited from providing any input into the development of the Self-build or Affiliate resource option by the Company or such Affiliate. Company RFP Team members are prohibited from sharing, either directly or indirectly through others, any Confidential Information (i.e. detailed evaluation criteria, other proposals, etc.) with any Self-Build or Affiliate Teams except in accordance with the procedures in the Code of Conduct, this Manual or the RFP.

Company RFP Team members and Company Self-Build Team members may continue to work with each other on projects not related to the RFP.

Further, members of each respective team do not have to be physically separated from each other but members of each team must take all reasonable measures to keep all Confidential Information (including electronic data) secure and inaccessible to the other team.

5. Communications among the Company RFP Team, the Company Self-Build Team and Shared Resources

Shared Resources may provide services to the Company RFP Team and the Company Self-Build Team. Shared Resources shall be limited as much as possible to instances where Company resources cannot provide a dedicated member to the Company RFP Team and the Company Self-Build Team at the same time and still provide the necessary functions of its area to the Company as a whole. Shared Resources are expressly prohibited from providing any Confidential Information developed on behalf of the Company RFP Team to the Company Self-Build Team, either directly or indirectly through others, or any Confidential Information developed on behalf of the Company Self-Build Team with the Company RFP Team, either directly or indirectly through others, except through the formal communication process outlined above, i.e., through the Company RFP website.

Additionally, Shared Resources are required to maintain a written record of the time, date and substance of all conversations, data and written material directly or indirectly exchanged with the Company RFP Team, the Company Self-Build Team and any affiliates that pertain to the RFP. A SharePoint-based interface will be set up and managed by the Energy Contract Manager to provide an easy to use and understand mechanism to log and memorialize these conversations.

Shared Resources will not have direct access to the Company's shared drive developed for the RFP process which will include documentation of the bid evaluation results. As noted above, Shared Resources shall have

no input into and shall not participate in the evaluation process for any particular RFP.

6. Communications between the Company RFP Team, the Company Self-Build Team and any Unassigned Company Resource or consultant that is not a Shared Resource.

There may be times, in which a Company RFP or Company Self-Build team member may need ancillary or other ministerial or administrative assistance that requires communication and/or assistance from Company personnel who are not on any team nor considered a Shared Resource. In such events, such personnel may assist the requesting team member on an *ad hoc* basis upon the following conditions:

a. The essential team member making the request must inform the Company personnel that sharing of the requested information or assistance with the other team, be it the Company RFP or Company Self-Build Team, is expressly prohibited under the Code of Conduct.

b. The assisting Company personnel shall complete the Code of Conduct training and sign the Competitive Bidding Code of Conduct Acknowledgement of Receipt form.

c. The assisting Company personnel shall be directed to the Company RFP and Company Self-Build Team rosters provided by such requesting team member to determine and/or confirm the restrictions on communication with the other team members. The essential team member making the request will ensure the roster of Unassigned Company Resources is updated by the Energy Contract Manager to include the assisting Company personnel.

d. Unassigned Company Resources will be required to maintain a written record of the time, date and substance of all conversations, data

and written material directly or indirectly exchanged with the Company RFP Team, the Company Self-Build Team and any affiliates that pertain to the RFP. A SharePoint-based interface will be set up and managed by the Energy Contract Manager to provide an easy to use and understand mechanism to log and memorialize these conversations. Unassigned Company Resources are expressly prohibited from providing any Confidential Information developed on behalf of the Company RFP Team to the Company Self-Build Team, either directly or indirectly through others, or any Confidential Information developed on behalf of the Company Self-Build Team with the Company RFP Team, either directly or indirectly through others, except through the formal communication process outlined above, i.e., through the Company RFP website.

e. If assistance from Unassigned Company Resource becomes more than occasional or more substantive than ancillary, ministerial or administrative services, the Unassigned Company Resource should be considered for inclusion on the team that he/she has been assisting on such basis. Additionally, the Unassigned Company Resource may also be considered for inclusion as a Shared Resource. Members of the Company RFP Team shall consult with the Energy Contract Manager for the RFP for resolution. Members of the Company Self-Build Team shall consult with the Director of Energy Procurement through the Company RFP website for resolution.

7. Communications between Company RFP Team, Company Self-Build Team and Company Management.

The Company RFP Team and the Company Self-Build Team will necessarily require management approval of the RFP and the Self-Build Proposal. Because of the size of the Company, it may be possible that a single employee (at whatever level) (the "Approver") may have approval responsibility for matters affecting the RFP and the Self-Build proposal. Approvers in this situation must use their best judgment in

making decisions reviewing and approving matters for the respective teams. The Code of Conduct must be adhered to in these situations and the Approver must not communicate, either directly or indirectly through others, Confidential Information learned from the Company RFP Team with the Company Self-Build Team.

If an Approver feels that he/she cannot manage this potential conflict, the Approver is recommended to consult with his/her immediate supervisor to determine whether such higher authority could be appointed with the task of reviewing and approving matters for a designated team, either the Company RFP Team or the Company Self-Build Team. In matters where a team of employees (including one or more Approvers) is responsible for reviewing and approving matters for the respective teams, approving employees (from whatever level, including executives) with information from reporting personnel beneath them from both the Company RFP Team and the Company Self-Build Team may consider recusing himself/herself from the decision making if such employee cannot objectively make a decision on the matter.

Finally, an Approver may be a member of either the Company RFP Team and have a subordinate reporting to him/her that is a member of the Company Self-Build Team (and vice versa). In such situations, because the Code of Conduct prohibits communication between the teams, the manager must recuse himself/herself from the decision making and request his/her manager to review and approve the matter in his/her place.

In all instances, it is possible that any particular situation above may be addressed and/or resolved by the terms and conditions of the Company's internal code of conduct implemented for all employees and consultants of the Company. As appropriate, an Approver or any other team member, Energy Contract Manager, Director of Energy Procurement,

Manager of Renewable Acquisitions or Company Executive in Charge may involve the Company's Corporate Compliance Officer for input and possible resolution under the Company's internal code of conduct.

V. WHEN THE CODE OF CONDUCT BECOMES EFFECTIVE

A. No later than 30 days after the Commission opens the docket to issue an RFP the Code of Conduct for that RFP will be activated. However, if the Company Self-Build Team determines at any time that it will not pursue a Self-Build Option for a particular RFP, the Code of Conduct may be de-activated in consultation with and approval from the IO.

B. Upon the signal to activate Step 1 above, the Code of Conduct shall be activated and members of the Company RFP Team and the Company Self-Build Team must then conduct activities on the RFP or Self-build process in compliance with the Code of Conduct. Once identified and having commenced work, no information may be shared outside the respective team members with respect to the RFP or the Self-Build Option except through the formal communication processes outlined above.

C. Immediately upon assignment to a Company team (RFP or Self-Build), designated as a Shared Resource, or requested to assist as an Unassigned Company Resource, each such employee or consultant must review this Manual, and sign the Competitive Bidding Code of Conduct Acknowledgement of Receipt form.

D. Within the RFP process, after a member has been assigned to a particular team, he or she will not be able to transfer to a different team at a later date for any reason. It is the responsibility of each team to fill vacant team positions with employees that have not been previously assigned as a team member for a team.

E. Each employee and consultant working on the RFP shall review the Code of Conduct and sign an acknowledgement attesting to his/her compliance with the Code of Conduct for each subsequent year until the Code of Conduct is terminated.

F. The Energy Contract Manager will be responsible for maintaining the Code of Conduct organizational chart and the signed "Competitive Bidding Code of Conduct Acknowledgement of Receipt" forms. The Company Executive in Charge shall be responsible for ensuring compliance with the Code of Conduct and shall have the written authority and obligation to enforce the Code of Conduct.

VI. IMMEDIATE ACTIONS UPON ACTIVATION OF THE CODE OF CONDUCT

The following items are required to be completed as soon as possible after activation of the Code of Conduct but no later than the designated events specified for each item below.

A. No later than 30 days after the opening of the docket commencing an RFP, an organizational chart listing each employee (with their title) and consultants in their designated role; Company RFP Team, Company Self-Build Team, Affiliate Team, Shared Resource or Unassigned Company Resource. When the IO is appointed, this organizational chart shall be provided to him/her. The organizational chart shall be placed in an accessible database (such as the Company's SharePoint database) so that any Company personnel can access the database to determine the identity of the respective teams and Shared Resources and any Unassigned Company Resources.

B. Upon the finalization of the organizational chart for the RFP and upon each addition to any team, the Energy Contract Manager shall obtain signed copies of the Competitive Bidding Code of Conduct Acknowledgement of Receipt form by Affiliate Team members, and all employees (whether full-time, part-time, temporary, or contract) and consultants involved in the competitive bidding

process, such as members of the Company RFP Team, the Company Self-Build Team, Shared Resources or Unassigned Company Resources.

C. No later than 30 days after the opening of the docket commencing an RFP, establishment of the Company email address to accept requests for information from Proposers, including the Company Self-Build Team or any Affiliate Team.

D. No later than 30 days after the opening of the docket commencing an RFP, establishment of the Company secured site that houses the accessible database (such as SharePoint).

VII. WHEN THE CODE OF CONDUCT TERMINATES

The Code of Conduct for a specific RFP will terminate after the following two conditions are met:

A. When the final contract(s) with the successful proposer(s) is executed or when written notice of the RFP's termination is provided by the Director of Energy Procurement or his/her designee to the IO and the Commission.

B. A certification of Code of Conduct compliance by all employees participating in the specific RFP process is submitted by affidavit by the Company Executive in Charge.

VIII. DOCUMENTATION FORMS

The following documentation forms may be utilized by those Company personnel involved in the RFP. These forms may be amended from time to time as necessary. Additional forms may also be developed as determined necessary.

- Competitive Bidding Code of Conduct Acknowledgement of Receipt form
- Code of Conduct Attestation Form (annual/final)
- Communications Log for Shared Resources

- Organizational Chart for essential teams, Shared Resources and Unassigned Company Resources

DRAFT REQUEST FOR PROPOSALS
FOR
VARIABLE RENEWABLE DISPATCHABLE GENERATION

ISLAND OF O‘AHU

FEBRUARY 2, 2018

Docket No. 2017-0352

Appendix E – PowerAdvocate User Information



**Hawaiian
Electric**

Electronic Procurement Platform

1. “Sourcing Intelligence™,” developed by PowerAdvocate, is the Electronic Procurement Platform that the Company has licensed and will utilize for this RFP.
2. There are no license fees, costs, or usage fees to Proposers for use of the PowerAdvocate Platform.
3. To access the RFP, the Proposer must register as a “Supplier” on the PowerAdvocate platform. A Proposer must submit a separate registration on the PowerAdvocate platform for each separate Proposal and each separate Proposal variation submitted.

The number of Proposal variations a Proposer is allowed under one Proposal Fee is defined in Section 1.8.2 of this RFP. The number of registrations on the PowerAdvocate platform does not correspond with the number of Proposal Fees that must be submitted.

4. If a Proposer is already registered on the PowerAdvocate platform, the Proposer may use their current login information as one registration.
5. Each registration will require a unique username, unique email address, and unique company name. Proposers that require multiple registrations to submit multiple Proposals or Proposal variations should use the Company Name field to represent the Company Name, Proposal Number, and Variation Number (ex: CompanyNameP1V1). Proposers may use shorthand or clear abbreviations. Proposers are asked to refer to their chosen unique company name throughout when referring to it in text responses.
6. Proposers can register for an account on the PowerAdvocate Electronic Procurement Platform by clicking on the “Registration” button (located in the top right corner of the webpage) on the PowerAdvocate website at the following address:

www.poweradvocate.com

7. Proposers may contact PowerAdvocate technical support for technical questions on the use of the Electronic Procurement Platform, including help with registration or modification of registration if desired. Support is available from 8 AM to 8 PM Eastern Daylight Time (2 AM to 2 PM Hawaii Standard Time when daylight savings is in effect) Monday to Friday, with the exception of Holidays posted on the PowerAdvocate website, both by phone (857-453-5800) and by email (info@poweradvocate.com).

Contact information for PowerAdvocate Support can also be found on the bottom border of the PowerAdvocate website:

www.poweradvocate.com

8. In order to complete the registration, the Proposer will need to review and accept PowerAdvocate’s Terms of Use. The Terms of Use are available online and a copy is also attached for convenience in this Appendix E.

9. Once a Proposer has successfully registered as a Supplier with PowerAdvocate, the Proposer shall request access to the subject RFP event from the Company Contact via email through the RFP email address set forth in Section 1.6 of the RFP. The email request must list the Company Name field (ex: CompanyNameP1V1), as applicable, under which the Proposer has registered with PowerAdvocate.
10. Once the RFP event is opened, Proposers will have online access to general notices, RFP-related documents, and other communications via Sourcing Intelligence™, and may begin to submit their Proposal. Proposals will be accepted only through the PowerAdvocate Platform.

Instructions to Proposers – Electronic Procurement Platform

11. Prior to the opening of the RFP in Sourcing Intelligence™, Proposers are encouraged to familiarize themselves with Sourcing Intelligence™.
12. Proposers should note that they will not be able to access any Bid documents until the event officially opens in Sourcing Intelligence™.
13. An e-mail notification will be sent to all prospective Proposers via the messaging feature in Sourcing Intelligence™ when the event has been opened to receive Proposals.
14. Proposals must be submitted through Sourcing Intelligence™ before 2:00 p.m. Hawai'i Standard Time (HST) on the date shown in the RFP Schedule in Section 3.1 of this RFP. Sourcing Intelligence™ will not accept the submittal of late information for this RFP event. It is the Proposer's sole responsibility to ensure that its complete information has been submitted on time. Any proposal information that is merely SAVED, but not SUBMITTED will not be considered. The Proposal submission deadline via the PowerAdvocate platform is an Eligibility Requirement for this RFP. See Section 4.2 of this RFP.
15. All Proposals must be prepared in accordance with the procedures and format specified in this RFP document and in the event hosted on PowerAdvocate's Sourcing Intelligence™ Electronic Procurement Platform. Proposers are also required to respond to all questions and provide all information requested in the RFP and the bid event, as applicable. This process is intended to provide an orderly, consistent and fair evaluation of the Proposals.
16. Uploaded files must follow consistent naming conventions described herein. Names of electronic files uploaded to the Electronic Bidding Platform must include, in order, consistent company names, proposal number, variation number, technology, variation descriptor, and question number, for example:
"SupplierNameP1V1_Solar_wstorage_Q1.PDF".
Proposers may use shorthand if it is clear and easy to follow.
17. Input/submission items in the RFP that are not applicable to a specific Proposer, Proposal or Proposal variation must be clearly marked as "N/A" (Not Applicable) and provide a brief explanation for each item as marked.

18. It is the Proposer's sole responsibility to advise the Energy Contract Manager of conflicting requirements, ambiguities, omission of information, or the need for clarification prior to submitting a Proposal. The Company cautions proposers to allow sufficient time to receive a response and submit Proposals before the Proposal due date.
19. It is the Proposer's sole responsibility to ensure the timely submission of the completed Proposal. The Company will not be responsible for technical problems that interfere with the upload or download of Proposal information. PowerAdvocate provides live customer support Monday through Friday, from 8 AM to 8 PM, Eastern Standard Time (3 AM to 3 PM Hawai'i Standard Time when daylight savings is not in effect), and is closed on Holidays specified on the PowerAdvocate website..
20. Proposers are encouraged to start early, SAVE data frequently and avoid waiting until the last minute to SUBMIT the required information. Proposers are allowed to revise information that has been previously submitted, as well as add, modify and/or delete documents any time before the event closes. There is no limit to the size of a file that can be uploaded, but larger files will take longer. Multiple files can also be compressed into a .zip archive for upload.

PowerAdvocate Platform Submittal Procedures

21. After logging onto the PowerAdvocate Platform, the RFP will be visible on the Proposer's dashboard with several Tabulations (Tabs) each used for the following:
 - "Download Documents:" Documents stored under this tab are provided for the Suppliers use and information. All documents can be downloaded and/or printed, as required. If available, the Company's responses to Proposer questions will be posted in this tab.
 - "Upload Documents:" In addition to specific data that is requested through the datasheets stored under the Commercial, Technical and Pricing Data Tabs, files such as (spreadsheets, pdfs, word documents, signature statements, etc.) may be requested. Such files being submitted by the Supplier may be uploaded here.
 - "Commercial Data:" Proposers are required to fill in the Commercial datasheets.
 - "Technical Data:" Proposers are required to fill in the Technical datasheets.
 - "Pricing Data:" Proposers are required to fill in the Pricing datasheets.
22. All responses to this RFP shall be submitted in the English language.
23. All questions or concerns regarding the RFP shall be submitted to the Energy Contract Manger via the PowerAdvocate Messaging tab.
24. Questions regarding the PowerAdvocate platform ONLY should be directed to:

PowerAdvocate Support

E-mail: support@poweradvocate.com

Tel: 857-453-5800

PowerAdvocate Support will only answer questions related to the operation and functionality of the PowerAdvocate platform. Questions related to the RFP cannot be answered by PowerAdvocate Support. All RFP related questions should be directed to the Company Contact email address identified in Section 1.6 of this RFP.



PowerAdvocate Terms of Use (Version: January 1, 2010)

READ THESE TERMS OF USE CAREFULLY BEFORE USING THE SITE. BY USING OR ACCESSING THE SITE, YOU ACKNOWLEDGE THAT YOU HAVE READ, ACCEPT, AND AGREE TO BE BOUND BY THESE TERMS OF USE.

1. Background

Your use of www.poweradvocate.com (the Site) is governed by these PowerAdvocate Terms of Use (Terms of Use or Agreement). The password protected areas of the Site allows individuals or entities with registered Users (as defined below) to access and use the PowerAdvocate Energy Intelligence Platform. Your use of the Energy Intelligence Platform (or any of the individual products that comprise the Energy Intelligence Platform – Spend Intelligence, Cost Intelligence, Market Intelligence and Sourcing Intelligence as of the date hereof) is governed by these Terms of Use and by any license, subscription or other applicable written contract entered into by you or by the Participating Company (as defined below) or which you are a User. A Participating Company is an individual or a legal entity that has Users that have registered to participate on the Energy Intelligence Platform. The employees or authorized agents of a Participating Company are referred to as Users. A Participating Company submitting information on, or bids or offers to sell, goods or services (including any entity acting as a representative or agent or another) on Sourcing Intelligence is referred to as a Supplier Company. A Participating Company posting a request on the Sourcing Intelligence, or otherwise requesting or collecting information on, or receiving bids or offers for the purchase of, goods or services from Supplier Companies is referred to as a Buyer Company. Except as expressly stated otherwise, all terms apply equally to Supplier Companies and to Buyer Companies.

2. Registration

Each User must register on the Site before Users are authorized to participate on the Energy Intelligence Platform.

3. User Names and Passwords

Each User will be issued a unique user name and password upon registration. Each Participating Company agrees to take all reasonable precautions to maintain as confidential the user names and passwords of its Users. Each Participating Company agrees not to provide access to the Energy Intelligence Platform to any persons other than authorized Users through use of their user names or passwords and to notify PowerAdvocate upon becoming aware of any loss or theft of a user name or password or an unauthorized use of the Energy Intelligence Platform or a user name or password. A Participating Company will be responsible for all use of its user names and passwords by any person or entity. At its sole discretion and at any time, PowerAdvocate may disable one or more user names or passwords or otherwise deny a User access to the Energy Intelligence Platform.

4. PowerAdvocate's Role

PowerAdvocate may be involved on the Site in many ways, including by assisting a Buyer Company with the preparation and posting of a request or proposals on Sourcing Intelligence, by promoting Supplier Company participation, and by facilitating Participating Company use of the Energy Intelligence Platform through helpdesk services. PowerAdvocate will not take title to, or otherwise have any liability for, any products or services sold or offered for sale on the Site, and each Participating Company hereby releases PowerAdvocate from any such liability. PowerAdvocate is not responsible for any material posted on the Site by a Participating Company. PowerAdvocate has no obligation to monitor the content on the Site. PowerAdvocate has the right, but not the obligation, to remove any material posted on the Site, including any material that is alleged to violate an intellectual property right (whether or not the allegation proves accurate) or that may violate these Terms of Use or applicable laws.

5. Participating Company's Role

Each Participating Company is responsible for all activities carried out on the Energy Intelligence Platform by its Users, and ensuring that each of its Users abides by the Terms of Use, as they are amended from

time to time and appear on the Site. All Users must be employees or authorized agents of a Participating Company and authorized by that Participating Company to conduct business on the Energy Intelligence Platform. A Participating Company shall inform PowerAdvocate immediately of any change in a User's status that affects that User's right to use the Energy Intelligence Platform. Should a Participating Company fail to do so, that Participating Company will continue to be responsible for all the User's activities on the Energy Intelligence Platform. The applicable Buyer Companies and Supplier Companies are responsible for determining the final terms and conditions between them with respect to a purchase and sale of goods or services arising out of their use of Sourcing Intelligence, including pricing, warranties, logistics, transportation, and inspection as required. If a Buyer Company elects to purchase any goods or services, that Buyer Company and the successful Supplier Company(s) will enter into any contracts they deem necessary and PowerAdvocate will not be a party thereto. You and each Participating Company warrant and covenant that its Contact Information (as defined in paragraph 9), its posting of any materials on the Site, and its other uses of and activities on the Site do not and shall not: (a) infringe any third party's copyright, patent, trademark, trade secret or other intellectual property rights, or other proprietary rights or rights of publicity or privacy; (b) violate any law, statute, ordinance or regulation (including, without limitation, those governing export control, unfair competition, deceptive trade practices, and false advertising); or (c) constitute activities that are scandalous, deceptive, inaccurate, misleading, defamatory, libelous, obscene, harassing or threatening. You and each Participating Company will comply with all applicable laws, statutes, ordinances and regulations regarding its use of the Site, and regarding its ordering of, bidding on or purchase of goods and services, and its posting and retrieval of information, on or through the Site. Access to the Site by means of screen scrapers, web crawlers or similar methods is prohibited. Any Supplier Company acting as a representative or agent for another Supplier Company (e.g., a manufacturer's representative) acknowledges and agrees that these Terms of Use are intended to bind itself and the Supplier Company that it represents. Each Participating Company represents and warrants that it has all necessary right, title and interest to enter into this Agreement and to perform its obligations under this Agreement and, in the case of a Supplier Company acting as a representative for another Supplier Company, that it has the power to bind that other Supplier Company to these Terms of Use.

6. Third Party Links

The Site may contain links to third-party web sites not under the control or operation of PowerAdvocate. PowerAdvocate does not endorse these third-party web sites, and is not responsible for the contents of any linked site or any link contained in a linked site. You may provide a hypertext link to the Site on another web site, so long as such link is done in good taste and does not create the false appearance that PowerAdvocate is associated with or sponsoring the linking web site. The use of techniques to frame the Site within a third-party web site is not permitted under this Agreement. PowerAdvocate reserves the right to revoke its consent to any link at any time in PowerAdvocate's sole discretion.

7. Warranties and Limitations of Liability

THE SITE IS PROVIDED ON AN "AS IS" AND "AS AVAILABLE" BASIS. POWERADVOCATE AND EACH PARTICIPATING COMPANY WARRANTS AND COVENANTS THAT ITS CONTACT INFORMATION (AS DEFINED IN PARAGRAPH 9), ITS POSTING OF ANY MATERIALS ON THE SITE, AND ITS OTHER USES OF AND ACTIVITIES ON THE SITE DO NOT AND SHALL NOT: (a) INFRINGE ANY THIRD PARTY'S COPYRIGHT, PATENT, TRADEMARK, TRADE SECRET OR OTHER INTELLECTUAL PROPERTY RIGHTS, OR OTHER PROPRIETARY RIGHTS OR RIGHTS OF PUBLICITY OR PRIVACY; (b) VIOLATE ANY LAW, STATUTE, ORDINANCE OR REGULATION (INCLUDING, WITHOUT LIMITATION, THOSE GOVERNING EXPORT CONTROL, UNFAIR COMPETITION, DECEPTIVE TRADE PRACTICES, AND FALSE ADVERTISING); OR (c) CONSTITUTE ACTIVITIES THAT ARE SCANDALOUS, DECEPTIVE, INACCURATE, MISLEADING, DEFAMATORY, LIBELOUS, OBSCENE, HARASSING OR THREATENING. YOU AND EACH PARTICIPATING COMPANY WILL COMPLY WITH ALL APPLICABLE LAWS, STATUTES, ORDINANCES AND REGULATIONS REGARDING ITS USE OF THE SITE, AND REGARDING ITS ORDERING OF, BIDDING ON OR PURCHASE OF GOODS AND SERVICES, AND ITS POSTING AND RETRIEVAL OF INFORMATION, ON OR THROUGH THE SITE. ACCESS TO THE SITE BY MEANS OF SCREEN SCRAPERS, WEB CRAWLERS OR SIMILAR METHODS IS PROHIBITED. ANY SUPPLIER COMPANY ACTING AS A REPRESENTATIVE OR AGENT FOR ANOTHER SUPPLIER COMPANY (E.G., A MANUFACTURER'S REPRESENTATIVE) ACKNOWLEDGES AND AGREES THAT THESE TERMS OF USE ARE INTENDED TO BIND ITSELF AND THE SUPPLIER COMPANY THAT IT REPRESENTS. EACH PARTICIPATING COMPANY REPRESENTS AND WARRANTS THAT IT HAS ALL NECESSARY RIGHT, TITLE AND INTEREST TO ENTER INTO THIS AGREEMENT AND TO PERFORM ITS OBLIGATIONS UNDER THIS AGREEMENT AND, IN THE CASE OF A SUPPLIER COMPANY ACTING AS A REPRESENTATIVE FOR ANOTHER SUPPLIER COMPANY, THAT IT HAS THE POWER TO BIND THAT OTHER SUPPLIER COMPANY TO THESE TERMS OF USE.

DAMAGES (INCLUDING WITHOUT LIMITATION FOR LOST PROFITS, REVENUES OR DATA), ARISING OUT OF OR IN CONNECTION WITH THE SITE, USAGE OF THE SITE, OR THOSE RESULTING FROM ANY GOODS OR SERVICES PURCHASED OR OBTAINED OR MESSAGES RECEIVED THROUGH, OR TRANSACTIONS ENTERED INTO AS A RESULT OF USING THE SITE. THE LIMITATIONS OF LIABILITY PROVIDED IN THESE TERMS OF USE INURE TO THE BENEFIT OF POWERADVOCATE, AND ITS SUBSIDIARIES AND AFFILIATES, AND THEIR RESPECTIVE OFFICERS, DIRECTORS, EMPLOYEES, ATTORNEYS AND AGENTS. IN THE EVENT THAT A PARTICIPATING COMPANY HAS A DISPUTE WITH ANOTHER PARTICIPATING COMPANY, BOTH SUCH PARTICIPATING COMPANIES HEREBY RELEASE POWERADVOCATE, AND ITS SUBSIDIARIES AND AFFILIATES, AND THEIR RESPECTIVE OFFICERS, DIRECTORS, EMPLOYEES, ATTORNEYS AND AGENTS, FROM ALL CLAIMS, LOSSES, LIABILITIES, DEMANDS, AND DAMAGES OF EVERY KIND AND NATURE (DIRECT, INDIRECT, SPECIAL, PUNITIVE, CONSEQUENTIAL OR OTHERWISE) ARISING OUT OF OR IN ANY WAY CONNECTED WITH SUCH DISPUTE.

8. Confidential Information

PowerAdvocate recognizes the importance of protecting confidential and proprietary information collected or posted on the Energy Intelligence Platform and of not disclosing such information to unauthorized third parties. As such, PowerAdvocate enters into confidentiality agreements with PowerAdvocate customers that contain PowerAdvocate's sole obligations concerning the treatment of confidential or proprietary information collected or posted by that customer on the Site.

9. Intellectual Property

"PowerAdvocate" (alone and together with the three rings) is a registered trademark of Power Advocate, Inc. In addition, "Energy Intelligence Platform," "Spend Intelligence", "Cost Intelligence", "Market Intelligence", and "Sourcing Intelligence" are trademarks or service marks of Power Advocate, Inc. Unless otherwise noted on the Site, all other trademarks, service marks, and logos used in this Site are the trademarks, service marks or logos of their respective owners. All ownership rights -- including all right, title, and interest in all patents, copyright rights, trademarks, trade secrets and other intellectual property rights -- in the Site, including any software associated with the operation or functioning of the Site, are and will remain in PowerAdvocate or its licensors. You and each Participating Company will not undertake to copyright, trademark or patent the Site, or any portion thereof. You and each Participating Company acknowledge that all or portions of the Site (including the software and methodologies associated with the operation or functioning of the Energy Intelligence Platform) may be copyrighted, trademarked or patented by PowerAdvocate or another party. You and each Participating Company acknowledge that no such act will cause or be construed as causing any portion of the Energy Intelligence Platform to be in the public domain. You and each Participating Company will not, and will not attempt to, modify, reverse engineer, disassemble or decompile the Site, or permit or cause any third party to do so on our behalf. Any changes, advice, modifications or evaluations of or concerning the Site generated or proposed by any party will be the exclusive property of PowerAdvocate and will not give anyone other than PowerAdvocate any right, title or interest in or to the Site. All ideas, concepts, know-how or techniques relating to the use, operation or functioning of the Site will be the exclusive property of PowerAdvocate or PowerAdvocate's licensors. You and each Participating Company are granted only a limited, revocable, non-transferable license to print and download portions of any materials created by PowerAdvocate ("PowerAdvocate Materials") and posted on the Site solely for internal, non-commercial use, provided that any copyright notice and any other notices that appear on any such copies are maintained and unmodified. Any other use, copying, redistribution, publication, or retransmission of any portion of any PowerAdvocate Materials on the Site is strictly prohibited without the express written permission of PowerAdvocate. All PowerAdvocate Materials on the Site are, and shall continue to be, owned by PowerAdvocate. Each Participating Company shall also maintain any copyright notice and any other notices that appear on any materials created by any third party and posted on the Site. PowerAdvocate retains all rights to any data, modules, components, designs, utilities, subsets, objects, program listings, tools, models, methodologies, programs, systems, analysis frameworks, leading practices ("Technical Elements") owned or developed by PowerAdvocate prior to, or independent of, the provision of the Site (and any modifications or enhancements to PowerAdvocate's Technical Elements developed in the course of providing the Site) (collectively, "PowerAdvocate Technical Elements") and PowerAdvocate retains exclusive ownership rights to all PowerAdvocate Technical Elements. PowerAdvocate retains all rights to its knowledge, experience and know-how (including processes, ideas, concepts and techniques) acquired in the course of providing the Site, and, subject to the confidentiality obligations in the separate contracts referenced in Section 8, you and each Participating Company hereby grant to PowerAdvocate a perpetual, worldwide, paid-up license to use, copy, modify and or sublicense, in the course of

PowerAdvocate's business, any Technical Elements acquired or developed as a result of providing the Site.

0 Contact Information

"Contact Information" shall mean any and all contact information (name, address, phone numbers, email address) that you provide to PowerAdvocate during registration for the Energy Intelligence Platform or during any other use of the Site. During registration, you shall provide -- and Participating Company shall ensure that its Users provide -- true, accurate, current and complete Contact Information. During registration or any other use of the Site that collects Contact Information, you will ensure that all Contact Information is office or home office contact information and is not private home contact information. PowerAdvocate uses the Contact Information in furtherance of, and consistent with, the Site and otherwise in its normal course of business. By providing your Contact Information, you provide your consent to PowerAdvocate's contacting you by email or telephone in its normal course of business, including to determine your interest in any PowerAdvocate offerings.

Governing Law and Jurisdiction

This Agreement shall be deemed to have been made and performed entirely in the Commonwealth of Massachusetts, and shall be governed by and construed pursuant to the laws of the Commonwealth of Massachusetts without regard to its provisions regarding the conflicts of laws. You and each Participating Company and PowerAdvocate hereby agree the state and federal courts of Massachusetts shall be the exclusive forum and venue to resolve disputes involving PowerAdvocate and arising out of or relating to these Terms of Use or any use of the Site. By using the Site and thereby agreeing to these Terms of Use, you and each Participating Company consent to personal jurisdiction and venue in the state and federal courts in Massachusetts with respect to all such disputes.

Amendment

PowerAdvocate may modify this Agreement from time to time by posting the modified Agreement on the Site. Any use of the Site after the posting of the modified Agreement constitutes that user's and that Participating Company's agreement to be bound by such modified version of this Agreement. PowerAdvocate reserves the right to change the Site at its discretion at any time. PowerAdvocate may add or remove features, services or otherwise modify the Site, all without any liability whatsoever.

3 Order of Precedence

THESE TERMS OF USE SHALL OVERTRIDE ANY OTHER TERMS AND CONDITIONS OF ANY OTHER WRITTEN CONTRACT THAT YOU OR A PARTICIPATING COMPANY MAY HAVE WITH POWERADVOCATE OR WITH ANY OTHER PARTICIPATING COMPANY. In the event of any conflicting terms under a written contract signed by you or a Participating Company with PowerAdvocate and these Terms of Use, the terms of the written contract will prevail over the conflicting terms in these Terms of Use.

Miscellaneous

Any notice, report, approval, or consent required or permitted under this Agreement shall be in writing and in the English language. Notices to PowerAdvocate may be sent to Power Advocate, Inc., 179 Lincoln Street, Boston, MA 02111, Facsimile: 857-453-5656, Attention: Daniel P. Sullivan. No failure or delay in exercising any right under this Agreement will operate as a waiver thereof, nor will any partial exercise of any right or power under this Agreement preclude further exercise. If any provision of this Agreement is unenforceable or invalid, that provision shall be limited or eliminated to the minimum extent necessary so that this Agreement shall otherwise remain in full force and effect and enforceable. For all purposes under this Agreement, each party shall be and act as an independent contractor of the other and shall not bind nor attempt to bind the other to any contract with third-parties. No agency, partnership, joint venture, employee-employer, or franchisor-franchisee relationship is intended nor created by this Agreement.



Sourcing Intelligence® Quick Start for Suppliers

PowerAdvocate Sourcing Intelligence enables suppliers to access buyer documents and submit documents over a web-based sourcing platform.

Logging In

1. Launch a web browser and go to www.poweradvocate.com.
2. Click the orange **Login** button.
3. Enter your account **User Name** and **Password** (both are case-sensitive) and click **Login**.
4. Click the **Events** tab if it is not already displayed.

Dashboard

Your Dashboard lists the events you have been invited to. A line divides currently accessible events from others.

Click to view Supplier Intelligence Dashboard

Click to view Contract Intelligence Dashboard

Buyer filter

Navigation bar

Dashboard Profile Company Help Logout

Events Portals Contracts

Dashboard

Company Filter: All Companies

Fill-In Data Sheets

Event / Buyer	Msg	Open	Close	Download Documents	Upload Documents	Commercial	Technical	Pricing
190-cb1-1: 190 First St. Cable/Wiring Electric Power Utility		05/16/10 8:00 AM EDT	06/08/10 4:00 PM EDT	1	2	3	4	5
T42g: Colorado River Sluice Gates Great Western Utilities	1/1	04/04/10 10:00 AM EDT	06/30/10 4:00 PM EDT	1	2	3	4	5
1998-01: Grid Expansion Electric Power Utility		09/01/10 8:00 AM EDT	12/29/10 4:00 PM EST	1	2	3	4	5

Buying entity

Click to view the event's Status tab

Number of unread/total messages

Click to view the event's Messaging tab

Click numbers to view event tabs

Datasheet available

No datasheet available

Open & Pending Pre-Bid events

Pending (no Pre-bid) and Closed events

- Click an event name to view its Status tab, which displays a summary of your activity and key event dates. To view specific details of an event, click the buttons **1 2 3 4 5** to view the corresponding tab.
- To return to the Dashboard, click **Dashboard** in the navigation bar at the top of the window.
- An event will not appear on your Dashboard until the Bid Event Coordinator has added you as a participant.

In addition to the Events tab, you may also see:

- An **Opportunities** tab, if a buyer opens an event to all PowerAdvocate suppliers; you can review a high-level event description, and may request full access to the event.
- A **Portals** tab, if a buyer subscribes to PowerAdvocate Supplier Intelligence
- A **Contracts** tab, if a buyer subscribes to PowerAdvocate Contract Intelligence.

Downloading Bid Packages

All of the buyer's bid package documents, including specifications and engineering drawings, are centrally stored on the PowerAdvocate platform. To view bid documents, click **1** on your Dashboard or on the **1. Download Documents** tab from within the event.

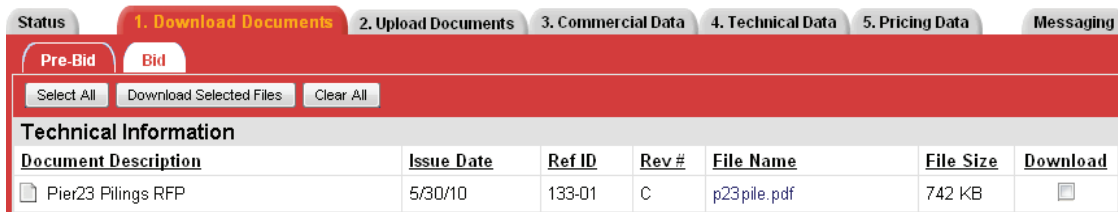

- You can access the **Bid** sub-tab after the bid opens. You can access Buyer documents before the event from a **Pre-Bid** sub-tab if the buyer requires a Pre-Bid submittal; the buyer must approve your submittal before you can access the **Bid** sub-tab. Likewise, you will see a **Post Bid** sub-tab if the buyer invites you to participate in post-bid negotiations.
- To view or download a document, click the file name; you may be prompted to open or save the file.
- To download multiple documents:
 1. Select the checkbox in the **Download** column for each document you wish to download, or click **Select All**.
 2. Click **Download Selected Files**.
 3. Click **Start** to download a .zip file containing the selected documents.

Uploading Documents

To upload your documents, click **2** on your Dashboard, or on the **2. Upload Documents** tab from within the event.

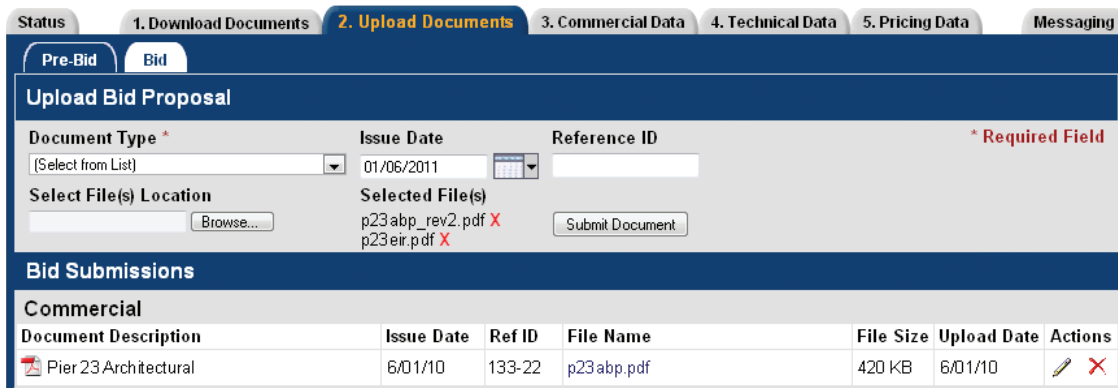

- As with the **1. Download Documents** tab, you may be able to access and upload documents to **Pre-Bid**, **Bid**, and **Post Bid** sub-tabs as appropriate.
- To upload a document:
 1. Specify a **Document Type**, and edit the Issue Date and Reference ID if necessary.
 2. Click **Browse**, navigate to and select the document, and then click **Open**; multiple files can also be compressed into one .zip file for upload.
 3. Click **Submit Document**.
- Late documents are accepted at the Buyer's option, but are flagged in red text.

Completing Datasheets

To view the event datasheets, click **3**, **4**, **5** on your Dashboard or on the **3. Commercial**, **4. Technical**, or **5. Pricing** tabs from within the event. Buttons/tabs are grayed out (e.g., **3**) if the buyer did not create a particular type of datasheet.

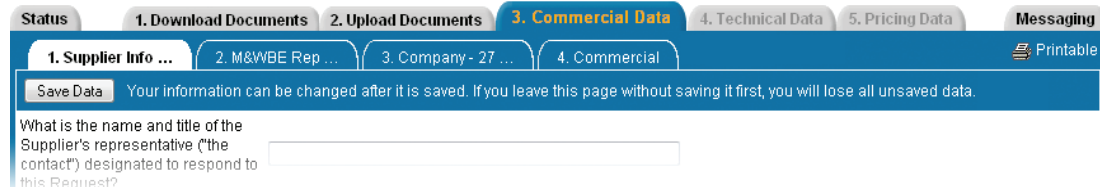

- Complete the datasheets over the course of the Bid Open period; datasheets may have multiple sub-tabs.
- Click **Save Data** often to avoid data loss. Once the bid closes, saved data is automatically submitted to the buyer.
- Once the bid closes, you are normally unable to modify datasheets. However, at the buyer's option, you may upload additional documents on the **2. Upload Documents** tab (which are flagged as being late).
- To view a printer-friendly version of a datasheet, click **Printable**.

Communicating with the Bid Event Coordinator

Buyer companies use one of two communication options in Sourcing Intelligence: Email or PowerAdvocate Messaging.

Email

Click the icon next to the Buyer Contact's name to contact them through your default email application (e.g., Outlook).



PowerAdvocate Messaging

To send a message to the Bid Event Coordinator (BEC), go to the **Messaging** tab and click **Create New Message**. To read or reply to a message from the BEC, click the message subject.

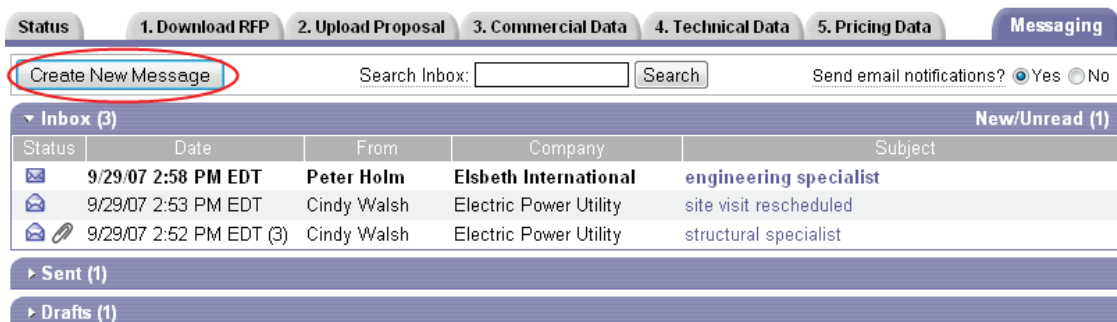

- You can send messages to the BEC and Buyer team; replies are sent your Supplier team and the Buyer team.
- BECs can message the Buyer team and all Supplier teams at once; Supplier teams can respond but not see other Supplier teams' responses.
- Supplier teams cannot message each other, or see other Supplier teams' correspondence with the Buyer team.
- You can receive external email notification of new PowerAdvocate messages.

Getting More Information

- Click **Help** on the navigation bar to display the online help.



- Supplier documentation can be downloaded from the online help system.
- Call PowerAdvocate support at 857-453-5800 (on-Fri, 8 a.m. to 8 p.m. Eastern Time) or email support@poweradvocate.com.

ay 2016

PowerAdvocate Sourcing Intelligence®



Suppliers' Frequently Asked Questions
May 2016

How do I log in to Sourcing Intelligence?

1. Launch a web browser and go to www.poweradvocate.com, and then click the orange **Login** button.
2. Enter your account **User Name** and **Password** (both are case-sensitive).
3. Click **Login**.

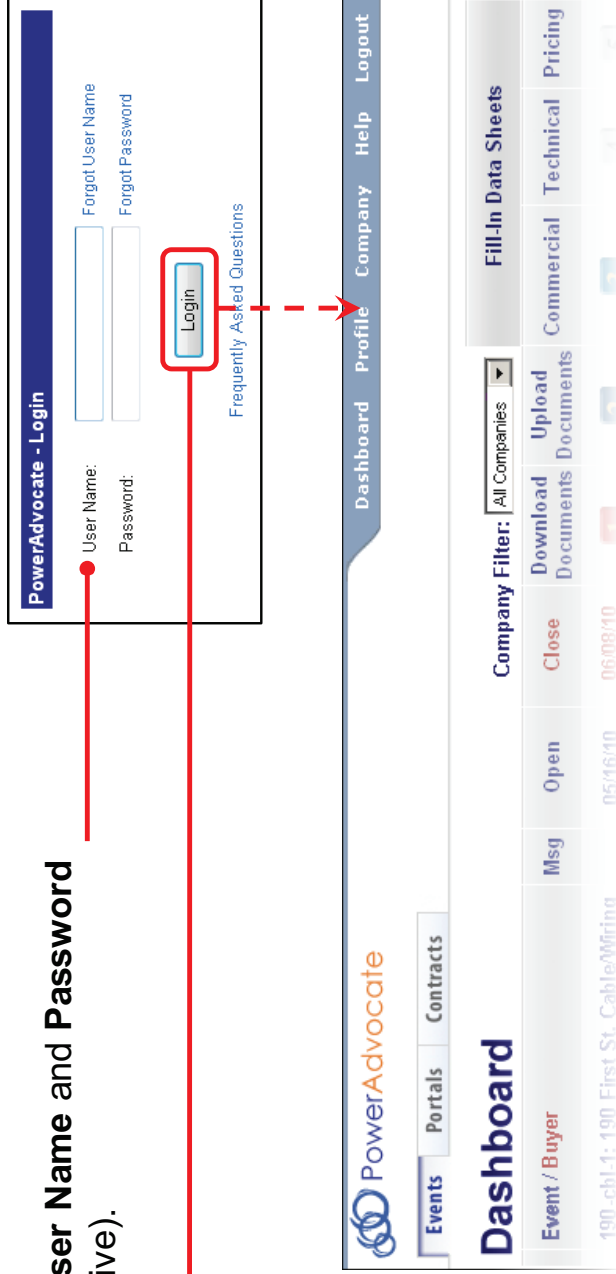

Tips

- Participating in a Reverse Auction requires logging into PowerAdvocate using IE9 or higher.
- If you received an email from a Bid Event Coordinator inviting you to register, follow the instructions in the email to complete the registration process.
- **Portals** and **Contracts** tabs may appear if buyers also subscribe to Supplier Intelligence or Contract Intelligence, respectively. An **Opportunities** tab may also appear, which is described on page 5.

How do I get more information if I need it?

You can contact PowerAdvocate Support at support@poweradvocate.com or by calling **857-453-5800**, Monday through Friday (excluding U.S. Federal Holidays) from 8:00 AM to 8:00 PM Eastern Time

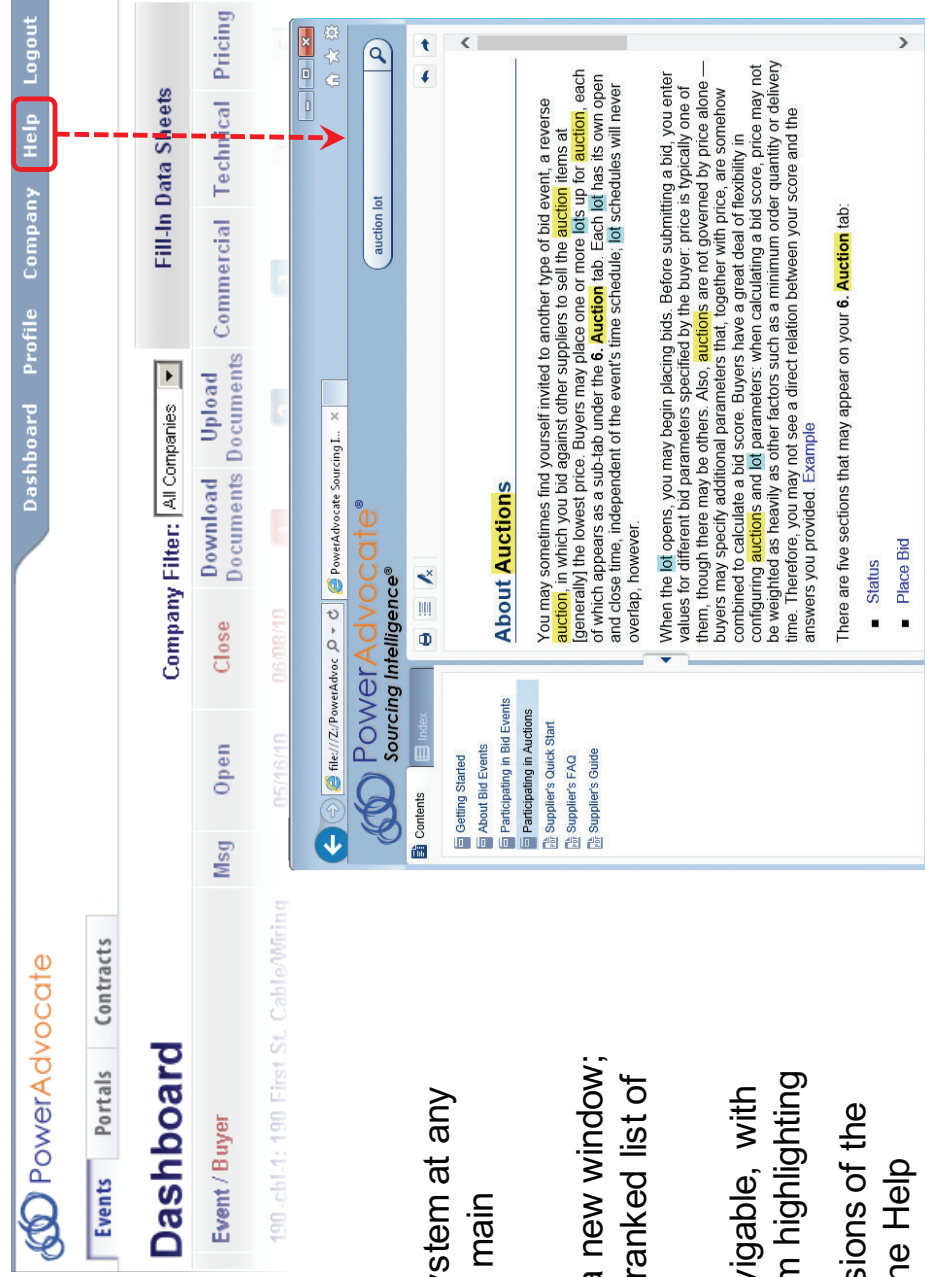

The screenshot displays the PowerAdvocate Sourcing Intelligence dashboard. At the top, there is a navigation bar with tabs for 'Events', 'Portals', and 'Contracts'. Below this, the 'Dashboard' section is visible, featuring a 'Company Filter' set to 'All Companies' and buttons for 'Download Documents', 'Upload Documents', 'Open', 'Close', 'Msg', and 'Event / Buyer'. A red dashed box highlights the 'Help' button in the top right corner of the dashboard. A red arrow points from this box to a search bar in the top right of the main content area, which contains the text 'auction lot'. Below the search bar, there is a 'Contents' section with links to 'Getting Started', 'About Bid Events', 'Participating in Bid Events', 'Participating in Auctions', 'Supplier's Quick Start', 'Supplier's FAQ', and 'Supplier's Guide'. The main content area is titled 'About Auctions' and contains text explaining the auction process, including terms like 'lot', 'lot schedule', and 'lot overlap'. A 'Status' section at the bottom right of the main content area lists 'Status' and 'Place Bid'.

Online Help

- You can access the Help System at any time by clicking **Help** on the main navigation bar
- The Help System opens in a new window; use full-text search to get a ranked list of relevant help topics
- The Help System is fully navigable, with features such as search term highlighting
- You can download PDF versions of the documentation from within the Help System

What information is displayed on my Dashboard?

Your Dashboard displays all bid events to which you have been invited.

Dashboard		Company Filter: All Companies		Fill-In Data Sheets				
Event / Buyer	Msg	Open	Close	Download Documents	Upload Documents	Commercial	Technical	Pricing
190 -cbl-1: 190 First St. Cable/Wiring Electric Power Utility		05/16/10 8:00 AM EDT	06/08/10 4:00 PM EDT	1	2	3	4	5
T42g: Colorado River Sluice Gates Great Western Utilities	1/1	04/04/10 10:00 AM EDT	06/30/10 4:00 PM EDT	1	2	3	4	5
1998-01: Grid Expansion Electric Power Utility		09/01/10 8:00 AM EDT	12/29/10 4:00 PM EST	1	2	3	4	5

Open and Pending Pre-Bid events

Pending (not Pre-Bid) and Closed events

Buying entity

Event name/number

Number of unread/total messages; click to access the **Messaging** tab.

The numbers on the Dashboard represent a general workflow, though you can work in any order:

- 1 Download the bid package.
- 2 Upload bid documents, proposals, etc.
- 3 4 5 Fill in online datasheets if present.

Tips

- If an event is missing a type of datasheet, that number & its corresponding tab are grayed out (e.g., 3).
- Events with links in the **Msg** column use PowerAdvocate Messaging; others use standard email.
- Supplier contacts are invited individually by the buyer

How do I find other supplier opportunities?

Buyer companies have the option to make their bid events visible to all PowerAdvocate-registered suppliers.

When these opportunities exist, your **Opportunities** tab displays some high-level event information for you to evaluate.

To request access to a posted event:

1. Click .
A pop-up appears asking you to verify your qualifications. You may also enter Optional Comments to the buyer, if you have something to add.
2. Click **Submit Request**.
The Accessible column will display Pending until the buyer approves your request. Once approved, the event will appear on your Events tab. If the buyer does not approve your request, the event will be removed from your Opportunities tab.

Events		Opportunities				
Opportunities Dashboard						
Event Title	Company	Products / Services	Open Date	Close Date	Accessible	
<input type="checkbox"/> Actuators	Acme Electric	Controls	08/18/2015 8:00 AM EDT	08/31/2015 4:30 PM EDT		
<input type="checkbox"/> Next-Gen Boiler Upgrade	Universal Energy	Boiler Components	08/15/2015 8:00 AM EST	12/31/2015 4:00 PM EST		
Description: Looking for a cutting-edge implementation for a green building in the planning stages.						
<input type="checkbox"/> Project Simulator	Solar Arrays LLC	Construction Services	08/01/2015 8:00 AM EDT	09/07/2015 4:00 PM EDT	Pending	
<input type="checkbox"/> Site 101 Rough-out	Sheridan Builders	Piping	07/01/2015 9:00 AM EDT	12/31/2015 6:00 PM EST		

How do I access the buyer's bid package?

Once a buyer invites you to participate in a bid event, that event appears on your Dashboard. You can begin downloading the buyer's bid documents after the event opens. From the Dashboard, click **1** to access the **1. Download Documents > Bid** tab, where you can download the buyer's entire bid package, download selected documents, or view individual documents online.

If the buyer invites you to Pre-Bid, you can access documents from the **1. Download Documents > Pre-Bid** tab before the event opens; the buyer must approve your Pre-Bid submittal before you can access the **Bid** sub-tab. Likewise, a **1. Download Documents > Post Bid** sub-tab indicates an invitation to post-bid negotiations.

Click **Download Selected Files** to download the selected documents.

1. Download Documents

Pre-Bid **Bid**

Select All Download Selected Files Clear All

Technical Information

Document Description	Issue Date	Ref ID	Rev #	File Name	File Size	Download
Pier23 Piling RFP	5/30/10	133-01	C	p23pile.pdf	742 KB	<input type="checkbox"/>

Click **Select All** to select all files in the bid package.

Click a document **File Name** to open and view it online

If there are multiple documents, you can selectively download them

Tip

- Selected documents are saved in a .zip file named **BidPackage-nnnn-n.zip** (nnnn-n is a unique ID).

How do I submit documents to the buyer?

1. Go to the **2. Upload Documents** tab and select the appropriate sub-tab.

2. Select a **Document Type** and enter a brief **Document Description**.

3. Click **Browse**, navigate to your document, and click **Open**.

4. Click **Submit Document**.

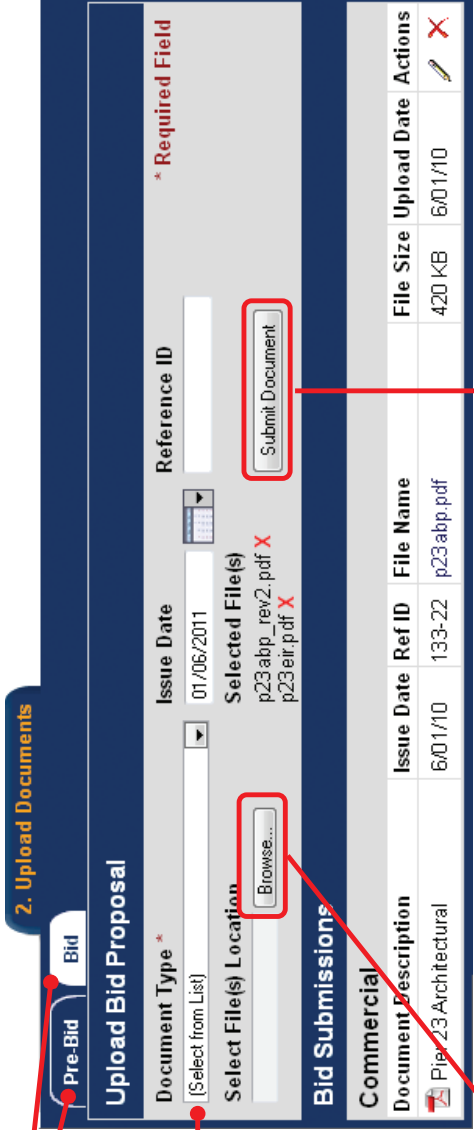

Tips

- **Issue Date** and **Reference ID** are optional, though they are helpful for tracking documents.
- You can add, modify (✎), or delete (X) documents at any time before the event closes.
- There is no limit on the number or size of documents that you can upload; multiple files can also be compressed into a .zip archive for upload.
- Late documents, if the buyer opts to accept them, are flagged in red text.

How do datasheets work?

In addition to your proposal, buyers often request that you complete datasheets as part of your bid package. Datasheets are online forms that allow buyers to collect specific data to tabulate and compare across suppliers.

2. Fill out the required information in the online form.

1. Click one of the datasheet tabs.



3. Click **Save Data**.

Tips

- Multiple users from the same company cannot simultaneously fill out a datasheet — when one user saves, others' work will be lost.
- Be sure to click **Save Data** before navigating elsewhere, or data may be lost. Save your work often.
- There is no **Submit** button. Data is automatically submitted when the bid closes.
- The buyer may block access to datasheets once the bid closes.

How do I communicate with the buyer? (1 of 2)

The buyer uses one of the following messaging options in Sourcing Intelligence:

- **Standard email** – Click an  icon to create a message to the buyer contact in your default email application.

17579 : Widgets and Gizmos **Electric Power Utility**
Open: 08/19/09 08:00:00 AM EDT Close: 09/15/09 04:00:00 PM EDT Time Remaining: 21 days 2 hours 56 mins 5 secs

Buyer Contact: Cathy Walsh 

Status

1. Supplier Info ... 2. M&WEE Rep ... 3. Company - 27 ... 4. Commercial 5. Pricing Data

1. Download Documents 2. Upload Documents 3. Commercial Data 4. Technical Data 5. Pricing Data

1. Supplier Info ... 2. M&WEE Rep ... 3. Company - 27 ... 4. Commercial

Save Data Your information can be changed after it is saved. If you leave this page without saving it first, you will lose all unsaved data. 

- **PowerAdvocate Messaging** – See the following slide.



How do I communicate with the buyer? (2 of 2)

To create a message in PA Messaging:

1. Click the event's **Messaging** tab or the link in the **Msg** column on your Dashboard.
2. Click **Create New Message**.

The screenshot shows the PA Messaging interface. At the top, there are tabs for 'Status', '1. Download RFP', '2. Upload Proposal', '3. Commercial Data', '4. Technical Data', '5. Pricing Data', and 'Messaging'. Below the tabs, there is a 'Create New Message' button circled in red. To the right of this button is a search bar labeled 'Search Inbox:'. Below the search bar is a table with columns for 'Status', 'Date', 'From', 'Company', and 'Subject'. The table contains three rows of messages. The first row has a status of 'New/Unread (1)', a date of '9/29/07 2:58 PM EDT', from 'Peter Holm', company 'Eisbeth International', and subject 'engineering specialist'. The second row has a date of '9/29/07 2:53 PM EDT', from 'Cindy Walsh', company 'Electric Power Utility', and subject 'site visit rescheduled'. The third row has a date of '9/29/07 2:52 PM EDT (3)', from 'Cindy Walsh', company 'Electric Power Utility', and subject 'structural specialist'. The 'structural specialist' subject is highlighted with a red box. Below the table are buttons for 'Sent (1)', 'Drafts (1)', and 'View Message'. To the right of the 'View Message' button is a 'Subject: site visit rescheduled' section with a list of messages and their dates. Below this is a 'From:' section with the sender's name and email address, a 'To:' section with the recipient's name and email address, a 'Cc:' section with the recipient's name and email address, a 'Date:' section with the date and time, and a 'Subject:' section with the subject line. Below the 'Subject:' section is a 'Message:' section with the text of the message. At the bottom right of the 'Message:' section are buttons for 'Send', 'Save Draft', and 'Close'.

To view a message:

- Click the message subject or status icon ( / )

Tips

- New messages are sent to the Bid Event Coordinator and copied to the Buyer and Supplier Teams.
- Messages/file attachments are embedded within an event, and cannot be viewed outside of that event.
- Messages are sent to entire teams; one-to-one messaging is not allowed.
- You can choose to receive [external] email notifications of new event-related messages.

DRAFT REQUEST FOR PROPOSALS
FOR
VARIABLE RENEWABLE DISPATCHABLE GENERATION

ISLAND OF O‘AHU

FEBRUARY 2, 2018

Docket No. 2017-0352

*Appendix F – Mutual Confidentiality and
Non-Disclosure Agreement*



**Hawaiian
Electric**

APPENDIX F
MUTUAL CONFIDENTIALITY AND NON-DISCLOSURE AGREEMENT
Independent Power Producers – (“IPPs”)

This Mutual Confidentiality and Non-Disclosure Agreement (this “Agreement”) is effective as of _____, 20____ (the “Effective Date”) between **[INSERT NAME OF IPP]**, a **[State of incorporation/organization] [type of entity]** (“IPP”) and Hawaiian Electric Company, Inc. (the “Company”), a Hawai’i corporation (“Company”). In consideration of the mutual promises contained in this Agreement, including the provision of Confidential Information (as defined below) by either party to the other hereunder, and other good and valuable consideration, the receipt and sufficiency of which are hereby acknowledged, the parties agree as follows:

1. Background

The Company has or intends to issue a Request for Proposals (“RFP”) for renewable energy generation. The IPP has or intends to propose a nominal [] MW, **[TYPE OF PLANT]** plant located at **[LOCATION]** on the island of **[NAME OF ISLAND]**, State of Hawai’i (“Proposal”).

In connection with the IPP’s Project, the Company may conduct an interconnection requirements study (“IRS”) to establish the requirements for interconnection of the IPP’s proposed renewable energy generation facility to the Company’s electric grid. The RFP process may also result in the award of a potential power purchase agreement, the terms of which must be negotiated and agreed upon by the parties (“PPA Negotiations”). For purposes of this Agreement the term “Project” refers to the RFP, Proposal and potential IRS and PPA Negotiations.

In order to evaluate the Project, either party may from time to time provide to the other party certain Confidential Information, as defined herein. The parties are willing to provide such Confidential Information to each other upon the terms and conditions of this Agreement.

2. Confidential Information

Except as set forth in Section 3 below, “Confidential Information” means all non-public, confidential or proprietary information disclosed by either party (the “Provider”) to the other party (a “Recipient”) its affiliates and its and their directors, officers, employees, agents, advisors, consultants (including, without limitation, financial advisors, counsel and accountants) and controlling entities or individuals (collectively, “Representatives”) whether disclosed orally or disclosed or accessed in written, electronic or other form of media, and whether or not marked or otherwise identified as “confidential,” including, without limitation:

(a) all information concerning the Provider and its affiliates’, and their customers’, suppliers’ and other third parties’ past, present and future business affairs including, without limitation, finances, customer information, supplier information, products, services, designs,

processes, organizational structure and internal practices, forecasts, sales and other financial results, records and budgets, business, marketing, development, sales and other commercial information and strategies;

(b) information concerning the Company's generation, transmission, and distribution systems (e.g., engineering and operating characteristics of the Company's transmission lines and substations) ("Critical Infrastructure Confidential Information");

(c) the Provider's unpatented inventions (whether or not they are patentable), ideas, methods and discoveries, techniques, formulations, development plans, trade secrets, know-how, unpublished patent applications and other confidential intellectual property;

(d) all designs, specifications, documentation, components, source code, object code, images, icons, audiovisual components and objects, schematics, drawings, protocols, processes, and other visual depictions, in whole or in part, of any of the foregoing;

(e) any third-party confidential information included with, or incorporated in, any information provided by the Provider to the Recipient or its Representatives; and

(f) all notes, analyses, compilations, reports, forecasts, studies, samples, data, statistics, summaries, interpretations and other materials ("Notes") prepared by or for the Recipient or its Representatives that contain, are based on, or otherwise reflect or are derived from, in whole or in part, any of the foregoing.

3. Exclusions from Confidential Information

Except as required by applicable federal, state, or local law or regulation, the term "Confidential Information" as used in this Agreement shall not include information that:

(a) at the time of disclosure is, or thereafter becomes, generally available to and known by the public other than as a result of, directly or indirectly, any violation of this Agreement by the Recipient or any of its Representatives; provided, however, that Confidential Information shall not be disqualified as Confidential Information (i) merely because it is embraced by more general or generic information which is in the public domain or available from a third party, or (ii) if it can only be reconstructed from information taken from multiple sources, none of which individually shows the whole combination (with matching degrees of specificity);

(b) at the time of disclosure is, or thereafter becomes, available to the Recipient on a non-confidential basis from a third-party source, provided that such third party is not and was not prohibited from disclosing such Confidential Information to the Recipient by a contractual or other obligation to the Provider;

(c) was known by or in the possession of the Recipient or its Representatives, as established by documentary evidence, prior to being disclosed by or on behalf of the Provider pursuant to this Agreement;

(d) was or is independently developed by the Recipient, as established by documentary evidence, without reference to or use of, in whole or in part, any of the Provider's Confidential Information; or

(e) was or is learned of established entirely from public sources, as established by documentary evidence, without reference to or use of, in whole or in part, any of the Provider's Confidential Information.

The parties acknowledge and understand that the confidentiality obligations of this Agreement apply only to the Confidential Information shared in connection with the Project. The parties may share other information with each other under other agreements, provisions or understandings which are not related to the Project. Such information sharing shall be subject to the provisions of the agreements and confidentiality provisions associated thereto and this Agreement shall not be construed to infringe upon or apply to such agreements or provisions.

4. Non-Disclosure of Confidential Information

Unless otherwise agreed to in writing by the Provider, the Recipient agrees as follows:

(a) except as required by law, not to disclose or reveal any Confidential Information to any person or entity other than its Representatives who are actively and directly participating in the evaluation of the Project or who otherwise need to know the Confidential Information for the purpose of evaluating the Project.

(b) not to use Confidential Information for any purpose other than in connection with its evaluation of the Project or the consummation of the Project.

(c) except as required by law, not to disclose to any person or entity (other than those of its Representatives who are actively and directly participating in the evaluation of the Project or who otherwise need to know for the purpose of evaluating the Project) any information about the Project, or the terms or conditions or any other facts relating thereto, including, without limitation, the fact that discussions are taking place with respect thereto or the status thereof, or the fact that Proprietary Information has been made available to the Recipient or its Representatives.

(d) to use diligent efforts to safeguard and protect the confidentiality of the Confidential Information, including, at minimum, implementing the same commercial measures that the Recipient uses to protect its own confidential information. Before disclosing the Confidential Information to any Representative, the Recipient will inform such Representative of the confidential nature of such information, their duty to treat the Confidential Information in accordance with this Agreement and shall ensure that such Representative is legally bound by the terms and conditions of this Agreement or subject to confidentiality duties or obligations to the Recipient that are no less restrictive than the terms and conditions of this Agreement.

(e) Any provision herein to the contrary notwithstanding, the Company may disclose Confidential Information to the State of Hawai‘i Public Utilities Commission (“Commission”) and/or the State of Hawai‘i Division of Consumer Advocacy (including their respective staffs) provided that such disclosure is made under a protective order entered in the docket or proceeding with respect to which the disclosure will be made or any general protective order entered by the Commission.

5. Required Disclosure and Notice

If the parties or any of their Representatives become legally compelled (by deposition, interrogatory, request for documents, subpoena, civil investigative demand, court order, or similar process) to disclose any of the Confidential Information, the compelled party shall undertake reasonable efforts to provide the other party with notice within three (3) business days of such requirement or advice prior to disclosure so that the other party may (a) seek a protective order or other appropriate remedy, (b) consult with the other party with respect to the compelled party taking steps to resist or narrow the scope of such requirement or advice, and/or (c) waive compliance, in whole or in part, with the terms of this Agreement. If such protective order or other remedy is not obtained, or the other party waives compliance with the provisions hereof, the compelled party agrees to furnish only that portion of the Confidential Information which it is legally required to so furnish and, at the request of the other party, to use reasonable efforts to obtain assurance that confidential treatment will be accorded such Confidential Information, it being understood that such reasonable efforts shall be at the cost and expense of the party whose Confidential Information has been sought. In any event, neither the IPP nor any of its Representatives will oppose action by the Company to obtain an appropriate protective order or other reliable assurance that confidential treatment will be accorded the Confidential Information.

6. Return or Destruction of Confidential Information

At any time during or after the term of this Agreement, at the Provider’s written request, and in any event, upon the termination of the Agreement, the Recipient shall certify within ten (10) business days that it has destroyed all Confidential Information by using industry standard data elimination methods used to prevent unauthorized disclosure of information, and for Personally Identifiable Information (defined as personally identifiable information of individuals, and any information that may be used to track, locate or identify such individuals (or which is otherwise protected by privacy laws), including any automatically generated information (such as IP addresses and other customer identifiers) that identifies or is unique or traceable to a particular individual or computer or other electronic device capable of accessing the internet, including without limitation, name, address, telephone number, social security number, credit card account numbers, email addresses, user identification numbers or names and passwords, which is disclosed to the Recipient or its subcontractors in connection with this Agreement by the Provider, which products and services are used or intended to be used for personal, family or household purposes), such methods shall be consistent with Hawaii Revised Statute 487-R; provided, however, that with respect to Confidential information in tangible form, the Recipient may return such Confidential Information to the Provider within ten (10) business days in lieu of destruction. The Recipient’s sole obligation with respect to the disposition of any Notes shall be

to redact or otherwise expunge all such Confidential Information from such Notes and certify to the Provider that it has so redacted or expunged the Confidential Information. Notwithstanding the foregoing, with respect to any Confidential Information stored in Recipient's disaster recovery backups or other electronic archives, Recipient is not required to destroy such Confidential Information if it would impose a material cost or burden; provided, however, such Confidential Information shall be destroyed when such archives are destroyed in accordance with Recipients records retention policies.

7. Authority

Each party represents and warrants that it has full power and authority to enter into and perform this Agreement, and the person signing this Agreement on behalf of each has been properly authorized and empowered to enter into this Agreement, understands it and agrees to be bound by it.

8. No Representations or Warranties

Neither the Provider nor any of its Representatives make any express or implied representation or warranty as to the accuracy or completeness of any Confidential Information disclosed to the Recipient hereunder, and the Recipient agrees that it is not entitled to rely on the accuracy or completeness of any Confidential Information. Neither the Provider nor any of its Representatives shall be liable to the Recipient or any of its Representatives relating to or arising from the use of any Confidential Information or for any errors therein or omissions therefrom. Notwithstanding the foregoing, the Recipient shall be entitled to rely solely on such representations and warranties regarding Confidential Information as may be made to it in any final agreement relating to the Project, subject to the terms and conditions of such agreement.

9. No Other Obligations

Neither this Agreement nor the disclosure of the Confidential Information shall result in any obligation on the part of either party to enter into any further agreement with the other with respect to the subject matter hereof or otherwise, to purchase any products or services from the other, or to require either party to disclose any further information to the other. Nothing in this Agreement shall be deemed to constitute either party hereto as partner, agent or representative of the other party or to create any fiduciary relationship between the parties. Either party may offer products or services which are competitive with products or services now offered or which may be offered by the other. Subject to the express terms and conditions of this Agreement, neither this Agreement nor discussions and/or communications between the parties will impair the right of either party to develop, make, use, procure, and/or market any products or services, alone or with others, now or in the future, including those which may be competitive with those offered by the other. Whether or not the Project is consummated, neither party shall issue a press release or release any information to the general public concerning such transaction or the absence thereof without the express prior written consent of the other, and the parties agree that neither party will use the other's name whether by including reference to the other in any press release, list of customers advertising that its services are used by Company or otherwise, without written authorization by the respective party's authorized representative.

10. Property Rights in Confidential Information

All Confidential Information shall remain the sole and exclusive property of the Provider and nothing in this Agreement, or any course of conduct between the parties shall be deemed to grant to the Recipient any license or rights in or to the Confidential Information of the Provider, or any part thereof. Unless otherwise expressly agreed in a separate license agreement, the disclosure of Confidential Information to the Recipient will not be deemed to constitute a grant, by implication or otherwise, of a right or license to the Confidential Information or to any patents or patent applications of the Provider.

11. Publicly Traded Company

The IPP acknowledges that the Company's holding company is a publicly traded company, and that Confidential Information of the Company may constitute material, non-public information with respect to the Company. The IPP understands, and will advise its Representatives to whom Confidential Information of the Company is disclosed, of the restrictions imposed by the United States securities laws on (a) the purchase or sale of securities by any person in possession of material, non-public information with respect to such securities, and (b) the communication of material, non-public information with respect to securities to a person who may purchase or sell such securities in reliance upon such information.

12. Remedies

(a) Each party acknowledges and agrees that any breach or threatened breach of this Agreement may give rise to an irreparable injury to the Provider or its Representatives, for which compensation in damages is likely to be an inadequate remedy. Accordingly, in the event of any breach or threatened breach of this Agreement by the Recipient or its Representatives, the Provider shall be entitled to seek equitable relief, including in the form of injunctions and orders for specific performance, in addition to all other remedies available at law or in equity.

(b) In the event that the Recipient learns of dissemination, disclosure, or use of the Confidential Information which is not permitted by this Agreement, the Recipient shall notify the Provider immediately in writing and shall use reasonable efforts to assist the Provider in minimizing damages from such disclosure. Such remedy shall be in addition to and not in lieu of any other rights or remedies available to the Provider at law or in equity.

13. Cumulative Remedies

No rights or remedy herein conferred upon or reserved to either party hereunder is intended to be exclusive of any other right or remedy, and each and every right and remedy shall be cumulative and in addition to any other right or remedy under this Agreement, or under applicable law, whether now or hereafter existing.

14. Notice

(a) By delivering written notice, either party may notify the other that it no longer wishes to receive or provide Confidential Information. Any further information received or provided by the party who received such notice following receipt of such notice, shall not be subject to the protection of this Agreement.

(b) All notices, consents and waivers under this Agreement shall be in writing and will be deemed to have been duly given when (i) delivered by hand, (ii) sent by electronic mail ("E-mail") (provided receipt thereof is confirmed via E-mail or in writing by recipient), (iii) sent by certified mail, return receipt requested, or (iv) when received by the addressee, if sent by a nationally recognized overnight delivery service (receipt requested), in each case to the appropriate addresses and E-mail Addresses set forth below (or to such other addresses and E-mail addresses as a party may designate by notice to the other party):

(1) Company:

By Mail:

Hawaiian Electric Company, Inc.
P.O. Box 2750
Honolulu, Hawaii 96840
Attn: Director of Procurement, Renewable Acquisition
Department

Delivered By Hand or Overnight Delivery:

Hawaiian Electric Company, Inc.
Central Pacific Plaza
220 South King St, 21st Floor
Honolulu, HI 96813
Attn: Director of Procurement, Renewable Acquisition
Department

By E-mail:

Hawaiian Electric Company, Inc.
Attn: Director of Procurement, Renewable Acquisition
Department
Email: renewableacquisition@hawaiianelectric.com

With a copy to:

By Mail:

Hawaiian Electric Company, Inc.
Legal Department
P.O. Box 2750
Honolulu, Hawaii 96840

Delivered By Hand or Overnight Delivery:

Hawaiian Electric Company, Inc.
American Savings Bank Tower
1001 Bishop Street, Suite 1100
Honolulu, Hawaii 96813
Attn: Legal Department

By E-mail:

Hawaiian Electric Company, Inc.
Legal Department
Email: legalnotices@hawaiianelectric.com

(2) [Purchaser][Vendor][Supplier]

By Mail:

[INSERT ADDRESS/CONTACT]

Delivered By Hand or Overnight Delivery:

[INSERT ADDRESS/CONTACT]

By E-mail:

[INSERT ADDRESS/CONTACT]

With a copy to:

By Mail:

[INSERT ADDRESS/CONTACT]

Delivered By Hand or Overnight Delivery:

[INSERT ADDRESS/CONTACT]

By E-mail:

[INSERT ADDRESS/CONTACT]

15. No Waiver

Except as otherwise provided in this Agreement, no delay or forbearance of a party in the exercise of any remedy or right will constitute a waiver thereof, and the exercise or partial exercise of a remedy or right shall not preclude further exercise of the same or any other remedy or right.

16. Governing Law

This Agreement is made under, governed by, construed and enforced in accordance with, the laws of the state of Hawaii. Any action brought with respect to the matters contained in this Agreement shall be brought in the federal or state courts located in the State of Hawaii. Each party agrees and irrevocably consents to the exercise of personal jurisdiction over each of the parties by such courts and waives any right to plead, claim or allege that the State of Hawaii is an inconvenient forum or improper venue. Notwithstanding the foregoing, Company, at its option, may elect to submit any such dispute to binding arbitration pursuant to the commercial arbitration rules of Dispute Prevention & Resolution, Inc. or the American Arbitration Association then in effect in which case the parties agree that any alternative dispute resolution shall take place in the State of Hawaii.

17. Attorneys' Fees and Costs

If there is a dispute between the parties and either party institutes a lawsuit, arbitration, mediation or other proceeding to enforce, declare, or interpret the terms of this Agreement, then the prevailing party in such proceeding shall be awarded its reasonable attorneys' fees and costs.

18. Assignment Prohibited

This Agreement shall be binding upon and inure to the benefit of the parties hereto and their respective successors, legal representatives, and permitted assigns. Neither party shall have the right to assign any of its rights, duties or obligations under this Agreement, by operation or law or otherwise, without the prior written consent of the other party. Any purported assignment in violation of this section shall be null and void.

19. No Third Party Beneficiaries

Nothing expressed or referred to in this Agreement will be construed to give any person or entity other than the parties any legal or equitable right, remedy, or claim under or with respect to this Agreement or any provision of this Agreement. This Agreement and all of its provisions and conditions are for the sole and exclusive benefit of the parties and their successors and permitted assigns.

20. Entire Agreement

This Agreement constitutes the entire agreement between the Parties relating to the subject matter hereof, superseding all prior and contemporaneous agreements, understandings or undertakings, oral or written with respect to the subject matter. Any amendment or modification of this Agreement or any part hereof shall not be valid unless in writing and signed by the Parties. Any waiver hereunder shall not be valid unless in writing and signed via by the Party against whom waiver is asserted.

21. Term and Survival

This Agreement shall remain in full force and effect for a period of two (2) years from the Effective Date. All confidentiality obligations within this agreement shall survive following expiration or termination of this Agreement.

22. Severability

If any term or provision of this Agreement, or the application thereof to any person, entity or circumstances is to any extent invalid or unenforceable, the remainder of this Agreement, or the application of such term or provision to persons, entities or circumstances other than those as to which it is invalid or unenforceable, shall not be affected thereby, and each term and provision of this Agreement shall be valid and enforceable to the fullest extent permitted by law, and the parties will take all commercially reasonable steps, including modification of the Agreement, to preserve the economic "benefit of the bargain" to both parties notwithstanding any such aforesaid invalidity or unenforceability.

23. Negotiated Terms

The parties agree that the terms and conditions of this Agreement are the result of negotiations between the parties and that this Agreement shall not be construed in favor of or against any party by reason of the extent to which any party or its professional advisors participated in the preparation of this Agreement.

24. Counterparts and Electronic Signatures

This Agreement may be executed in counterparts, each of which shall be deemed an original, and all of which shall together constitute one and the same instrument binding all Parties notwithstanding that all of the Parties are not signatories to the same counterparts. For all purposes, duplicate unexecuted and unacknowledged pages of the counterparts may be discarded and the remaining pages assembled as one document. The parties agree that this Agreement and any subsequent writings, including amendments, may be executed and delivered by exchange of executed copies via E-mail or other acceptable electronic means, and in electronic formats such as Adobe PDF or other formats mutually agreeable the parties which preserve the final terms of this Agreement or such writing. A party's signature transmitted by E-mail or other acceptable electronic means shall be considered an "original" signature which is binding and effective for all purposes of this Agreement.

[Signature Page Follows]

IN WITNESS WHEREOF, each party has caused this Agreement to be executed on its behalf by a duly authorized representative, all as of the Effective Date.

HAWAIIAN ELECTRIC COMPANY, INC.
("HAWAIIAN ELECTRIC")

By: _____
Print Name: _____
Its: _____

[Insert Name of IPP]

("IPP")

By: _____
Print Name: _____
Its: _____

DRAFT REQUEST FOR PROPOSALS
FOR
VARIABLE RENEWABLE DISPATCHABLE GENERATION

ISLAND OF O‘AHU

FEBRUARY 2, 2018

Docket No. 2017-0352

Appendix G – Description of Available Sites



**Hawaiian
Electric**

**APPENDIX G
VARIABLE RENEWABLE DISPATCHABLE GENERATION
DESCRIPTION OF AVAILABLE SITES**

On December 12, 2016, the Hawaiian Electric Companies issued a Land Request for Information (“Land RFI”) seeking information on available land for potentially siting future utility scale renewable energy projects on the islands of O‘ahu, Maui, Moloka‘i, Lana‘i, and Hawai‘i. Information from responding landowners is available upon request by following the instructions at <http://hawaiianelectric.com/landrfi>.

This information is being provided for proposers’ consideration only. Project proposals submitted in response to this RFP are not required to be sited at a location identified through the Land RFI. Hawaiian Electric also makes no representations as to the suitability of the listed sites for renewable energy production with regard to resource quality, interconnection constraints, zoning and permitting issues, community support, or other issues. Proposers should perform their own evaluation of these factors in determining whether a site is suitable for renewable energy project development. After further evaluation, proposers that are interested in any of the identified Land RFI parcels are invited to engage in further discussions directly with landowners to negotiate any required rights to use the property.

Additionally, the following links to a few publicly available resources relating to renewable energy project siting and development from the Hawaii State Energy Office are being provided for use at proposers’ sole discretion:

Project Permitting Assistance and Resources

<http://energy.hawaii.gov/developer-investor/project-permitting-assistance-and-resources>

Provides numerous resources to support more informed and appropriate project siting and permitting, including the Permit Guide, Renewable Energy Permitting Consultants, DOH, ePermitting Portal, Renewable EnerGIS, Permitting Wizard, and the Renewable Energy Projects Directory.

Hawaii Clean Energy Programmatic Environmental Impact Statement

<http://energy.hawaii.gov/testbeds-initiatives/hawaii-clean-energy-peis/peis-overview>

The Hawaii Clean Energy Programmatic Environmental Impact Statement (PEIS) analyzes, at a programmatic level, the potential environmental impacts of clean energy activities and technologies in the following clean energy categories: (1) Energy Efficiency, (2) Distributed Renewables, (3) Utility-Scale Renewables, (4) Alternative Transportation Fuels and Modes, and (5) Electrical Transmission and Distribution

Hawaii Statewide GIS Program

<http://planning.hawaii.gov/gis/>

Provides Hawaii GIS data and other resources to support site identification and analysis

Aloha Aina: A Framework for Biocultural Resource Management in Hawai‘i’s Anthropogenic Ecosystems

https://nmshawaiihumpbackwhale.blob.core.windows.net/hawaiihumpbackwhale-prod/media/archive/council/pdfs/aloha_aina.pdf

A framework developed by the Hawaiian Islands Humpback Whale National Marine Sanctuary Advisory Council to integrate Native Hawaiian and Western scientific management approaches toward ecosystem management. While intended for the Sanctuary, this document provides useful insight into successful collaboration in Hawaii.

DRAFT REQUEST FOR PROPOSALS
FOR
VARIABLE RENEWABLE DISPATCHABLE GENERATION

ISLAND OF O‘AHU

FEBRUARY 2, 2018

Docket No. 2017-0352

Appendix H – (Reserved)



**Hawaiian
Electric**

DRAFT REQUEST FOR PROPOSALS
FOR
VARIABLE RENEWABLE DISPATCHABLE GENERATION

ISLAND OF O‘AHU

FEBRUARY 2, 2018

Docket No. 2017-0352

Appendix I – Interconnection Facilities and Cost Information



**Hawaiian
Electric**

Hawaiian Electric Company
APPENDIX I- INTERCONNECTION FACILITIES AND COST INFORMATION 2017

Developers are responsible for the cost of interconnecting their project with the Hawaiian Electric system. To assist developers in assessing the impacts of location on potential projects, the per unit cost figures provided in the sections and tables below are to be used to provide an approximate estimated cost for interconnecting, including substation, communications, and transmission or distribution line cost to the existing Hawaiian Electric System. The per-unit cost figures below should not be used to create a detailed project estimate. A detailed project estimate typically requires a certain level of engineering to assess project site conditions and to factor in other parameters specific to the project.

The project proposal must identify the components assumed for their project and the quantity assumed for each. Each table below provides notes on the assumptions for each of the unit cost estimates. If a proposed project’s requirements are different than what is assumed in the notes, the developer must identify each difference and provide an estimated additional cost or savings resulting from those different requirements.

2.1 Transmission & Distribution Line Interconnection Costs

Component	Description	Cost per mile
1	New 138 kV Overhead line (accessible 500' spans)	\$3,399,000
2	New 46 kV Overhead line (accessible 250' spans)	\$746,750
3	New 138 kV Overhead line (inaccessible 500' spans)	\$4,223,000
4	New 46 kV Overhead line (inaccessible 250' spans)	\$927,000
5	138 kV overbuild on existing 46 kV line (accessible 500' spans)	\$3,914,000
6	46 kV overbuild on existing 12 kV line (accessible 250' spans)	\$2,163,000
7	138 kV overbuild on existing 46 kV line (inaccessible 500' spans)	\$4,944,000
8	46 kV overbuild on existing 12 kV line (inaccessible 250' spans)	\$2,678,000
9	New 138 kV Underground line Dielectric Cable	\$10,609,000

Notes:

1. Easement and/or land costs are NOT included with these estimates.
2. EA/EIS cost are NOT included with these estimates.
3. Components 7 and 9 - Overbuilding a 138 kV line on existing 46 kV pole line assumes the removal of the existing 46 kV poles.
4. Components 6 and 8 – Overbuilding a 46 kV line on existing 12 kV pole line – assumes the removal of some of the existing 12 kV poles.
5. Components 3, 4, 7 and 8 include 25% contingency for inaccessible or mountainous areas.
6. All estimates are provided in 2017 dollars.
7. All estimates are single respective circuits (i.e. single 46 kV circuit or single 138 kV circuit with single 46 kV circuit underbuild).

8. Components 1, 3, 5 and 7 assume steel pole construction.
9. Components 2, 4, 6 and 8 assume wood pole construction.
10. Components 5 and 7 – Extending the 46 kV sized easement to a 138 kV sized easement – is NOT included with these estimates.
11. Components 6 and 8 - assumes the 12 kV sized easement is acceptable for a 46 kV line.
12. Component 9 - based on 1780 KCM AL 138kV (2000A) cable, includes duct bank and MH installation

2.2 Substation Interconnection Costs (Please Note: Requirements for Variable and Firm projects may differ)

2.2.1 Substation Interconnection Costs VARIABLE Projects

2.2.1.1 Substation (138kV) Interconnection Costs VARIABLE Projects

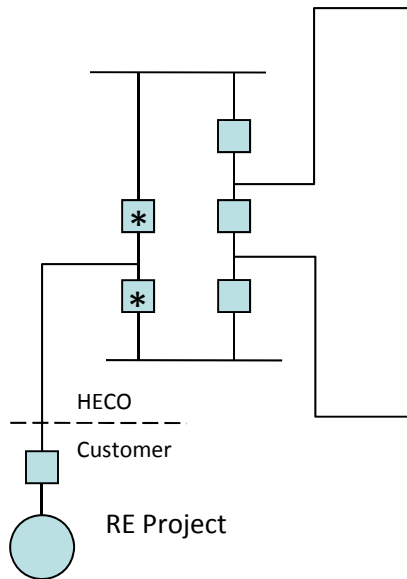

Component	Description	Cost
1	*2 – 138 kV circuit breaker addition to Existing Switching Station (HECO)	\$4,301,000

Notes:

1. Existing substation has been built to accommodate the addition of this 138kV breaker-and-a-half bay, including all groundwork (grading, grounding, rockfill, driveway, etc.) and fencing. Groundwork and fencing is not included in this estimate.
2. Costs are in 2017 dollars.

3. Estimate does not contain any of the following costs: Telecom, Relay Coordination Study, Land Cost, Environmental Assessment/Environmental Impact Statement, or Project Management.
4. Substation relay protection requirements have not been identified, so costs are based upon typical circuit breaker and line protection relaying requirements.

2.2.1.2 Substation (46kV) Interconnection Costs VARIABLE Projects

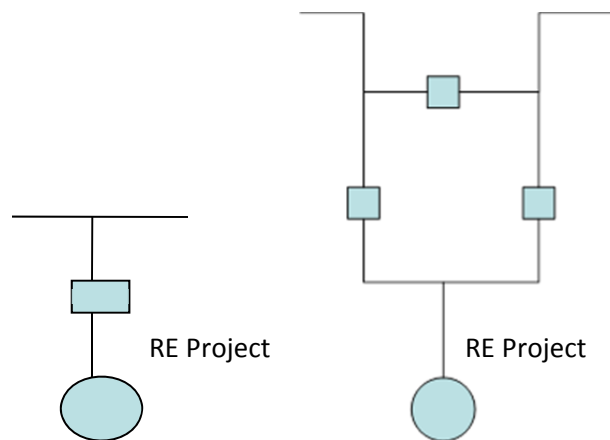

Component	Description	Cost
1	1 – 46 kV Breaker Switching Station	\$4,960,000
2	3 – 46 kV Breaker Switching Station	\$7,383,000

Notes:

1. Substation land that is received has been graded per Hawaiian Electric’s civil and structural requirements. Costs for excavation and fill are not included in the estimates.
2. Costs are in 2017 dollars.
3. Estimate does not contain any of the following costs: Telecom, Relay Coordination Study, Land Cost, Environmental Assessment/Environmental Impact Statement, or Project Management.
4. Substation relay protection requirements have not been identified, so costs are based upon typical circuit breaker and line protection relaying requirements.
5. Control house and SCADA are included in cost estimates.
6. The estimate is for a switching station, which does not contain any transformers.

2.2.2 Substation Interconnection Costs FIRM Projects

2.2.2.1 Substation (138kV) Interconnection Costs FIRM Projects

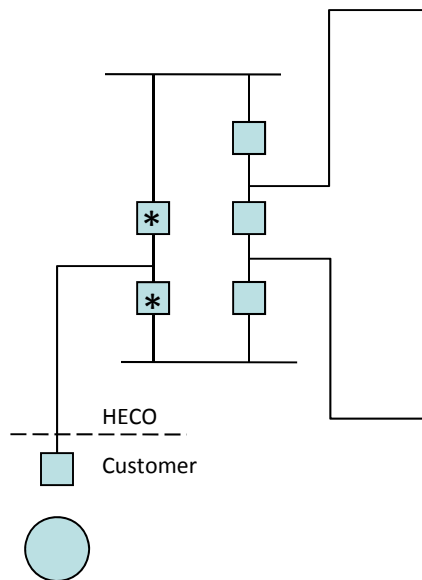

Component	Description	Cost
1	*2 – 138 kV circuit breaker addition to Existing Switching Station (HECO)	\$4,301,000

Notes:

1. Existing substation has been built to accommodate the addition of this 138kV breaker-and-a-half bay, including all groundwork (grading, grounding, rockfill, driveway, etc.) and fencing. Groundwork and fencing is not included in this estimate.
2. Costs are in 2017 dollars.
3. Estimate does not contain any of the following costs: Telecom, Relay Coordination Study, Land Cost, Environmental Assessment/Environmental Impact Statement, or Project Management.
4. Substation relay protection requirements have not been identified, so costs are based upon typical circuit breaker and line protection relaying requirements.

2.2.2.2 Substation (46kV) Interconnection Costs FIRM Projects

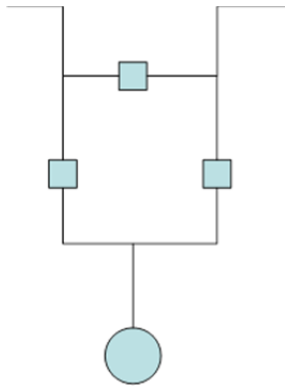

Component	Description	Cost
1	3 – 46 kV Breaker Switching Station	\$7,383,000

Notes:

1. Substation land that is received has been graded per Hawaiian Electric’s civil and structural requirements. Costs for excavation and fill are not included in the estimates.
2. Costs are in 2017 dollars.
3. Estimate does not contain any of the following costs: Telecom, Relay Coordination Study, Land Cost, Environmental Assessment/Environmental Impact Statement, or Project Management.
4. Substation relay protection requirements have not been identified, so costs are based upon typical circuit breaker and line protection relaying requirements.
5. Control house and SCADA are included in cost estimates.
6. The estimate is for a switching station, which does not contain any transformers.

2.3 Telecommunication Interconnection Costs

1. Point-to-point microwave: \$1,074,000 with the following assumptions:
 - a. There is line-of-sight between the communications endpoints.
 - b. FCC licensed Microwave Frequencies are available.
 - c. There are existing structures/buildings and available space on either end to house the radio equipment.
 - d. Telecommunications grounding standards are up-to-date at both sites.
 - e. 48 V DC power with 12 hour battery backup is available.

- f. This estimate does not include any special site-specific permit/approval that may be required.
 - g. Space is available to locate antenna towers/structures at both ends. Meets category 5 hurricane wind loading.
 - h. Interconnection to Hawaiian Electric's existing communications is not included.
2. Fiber with overbuild and new construction: \$211,000 per mile with the following assumptions:
- a. The poles are in good condition and do not need replacing.
 - b. The poles are not overloaded.
 - c. The poles and the attachments are in accordance with NESC 2002 and no work is required to upgrade the poles to current standards.
3. Supervisory Control and Data Acquisition (SCADA) Communications: \$84,000 with the following assumptions:
- a. 1.5 Mbps leased communications circuit is typically used for SCADA (Supervisory Control and Data Acquisition) applications via Fiber optics, or Ground Potential Rise (GPR) equipment where required.
 - b. Existing leased communications network is in close proximity to the substation.
 - c. Space is provided in control house or cabinet

DRAFT REQUEST FOR PROPOSALS
FOR
VARIABLE RENEWABLE DISPATCHABLE GENERATION

ISLAND OF O‘AHU

FEBRUARY 2, 2018

Docket No. 2017-0352

Appendix J – Rule 19 Tariff



**Hawaiian
Electric**

RULE NO. 19

Interconnection and Transmission Upgrades

A. GENERAL

1. Definitions

- a. "Betterment" means and includes any upgrading to a facility made solely for the benefit of and at the election of the Company, not attributable to the interconnection requirements. The Betterment includes any provisions for future expansion which cannot be charged to replacement. It also includes any related system work beyond that required for interconnection. If an existing facility is replaced with one of greater functional capacity or capability, the difference between the upgraded facility and a replacement facility of equivalent functional capacity is considered Betterment. It does not mean the substitution of a replacement facility for an existing facility, that is, an underground facility for an overhead facility, unless otherwise provided for in the RFP.

Example 1: A substation with a three breaker scheme is required to connect the Generating Facility to the grid. If the Company installs a substation with a six breaker ring bus scheme, the difference between installing a substation with a three breaker scheme and one with a six breaker scheme would be the Betterment.

Example 2: A transmission line needs to be upgraded to accommodate a new Generating Facility. The existing line is designed to withstand a 56 mph wind speed. The project includes upgrading the facilities to withstand a 100 mph wind speed. The increase in the design to the 100 mph wind speed criteria would be the Betterment.

Example 3: A transmission line needs to be upgraded to accommodate a new Generating Facility. In response to the Company's application to upgrade the line, the Commission orders that the line be placed underground. The cost difference between the overhead upgrade and the installation of the underground facilities would not be considered Betterment.

- b. "Company's Dispatch" means the Company's sole and absolute right to control, from moment to moment, through Supervisory Control, or otherwise, and in accordance with good engineering and operating practices in the electric utility industry, the rate of delivery of energy offered by the bidder to the Company.
- c. "Company's System" means the electric system owned and operated by the Company (to include any non-utility owned facilities) consisting of power plants, transmission and distribution lines, and related equipment for the production and delivery of electric power to the public.

HAWAIIAN ELECTRIC COMPANY, INC.

RULE NO. 19 - Continued

Interconnection and Transmission Upgrades

- d. "Distribution System" means all electrical wires, equipment, and other facilities at the distribution voltage levels (such as 25kV, 12kV, or 4kV) owned or provided by the Company, through which the Company provides electrical service to its customers.
- e. "Framework" means the Framework for Competitive Bidding dated December 8, 2006, adopted by the Commission in Docket No. 03-0372, Decision and Order No. 23121, which provides the mechanism for acquiring a future energy generation resource or a block of generation resources by the Company.
- f. "Generating Facility" means a bidder or utility-owned electrical energy generation resource that is interconnected to the Company electrical grid.
- g. "Grid Connection Point" means the point at which Interconnection Facilities connect to the Company's System, normally the Company's transmission grid. Facilities from the Generating Facility to the Grid Connection Point shall be considered Interconnection Facilities (see examples given in Attachment A). The Grid Connection Point will be identified in the IRS.
- h. "Interconnection Agreement" means a contract with the bidder that specifies the terms and conditions under which Interconnection Facilities (and, in some cases, certain System Upgrades) will be designed, installed, paid for, owned, operated and/or maintained. In some instances, such terms and conditions may be included in the PPA with a bidder, instead of in a separate Interconnection Agreement.
- i. "Interconnection Facilities" means the equipment and devices required to permit a Generating Facility to operate in parallel with and deliver electric energy to Company's System and provide reliable and safe operation of, and power quality on, the Company's System (in accordance with applicable provisions of the Commission's General Order No. 7, Company tariffs, operational practices and planning criteria), such as, but not limited to, transmission and distribution lines, transformers, switches, and circuit breakers.

Example 1: A wind farm facility constructed on a neighbor island (e.g. Molokai) that exports to the Company the energy it produces would be required to install undersea transmission lines to interconnect the Generating Facility to the Company's System. The undersea transmission lines and related facilities would be considered Interconnection Facilities.

HAWAIIAN ELECTRIC COMPANY, INC.

RULE NO. 19 - Continued

Interconnection and Transmission Upgrades

Example 2: A proposed Generating Facility is remotely located in a region of the island where there are no existing Transmission System facilities. In this case, if the size of the Generating Facility requires that it be tied to the existing Transmission System, the new Transmission System facilities (i.e. all electrical wires, equipment, and other facilities at the transmission voltage level) constructed from the Generating Facility to the Company's existing Transmission System facilities would be considered Interconnection Facilities.

- j. "Interconnection Requirements Study (IRS)" means a study, performed in accordance with the terms of the IRS Letter Agreement and with the applicable terms of the RFP and any resulting PPA, to identify the Interconnection Facilities, System Upgrades and other system requirements and all associated costs to integrate the proposed Generating Facility with the Company's System, and includes a detailed steady-state and a dynamic analysis. The IRS is conducted by the Company or its consultant and the bidder is responsible for the cost of conducting the IRS.
- k. "Interconnection Requirements Study Letter Agreement (IRS Letter Agreement)" means the letter agreement and any written, signed amendments thereto, between the Company and the bidder that describes the scope, schedule, and payment arrangements for the IRS.
- l. "IRP" means an electric utility's Integrated Resource Plan that has been submitted to the Commission for review and approval in the utility's IRP proceeding, in accordance with the Commission's IRP Framework.
- m. "IRP Framework" means the Commission's Framework for Integrated Resource Planning, dated May 22, 1992, as amended by In re Public Util. Comm'n, Docket No. 05-0075, Decision and Order No. 22490, filed on May 26, 2006.
- n. "Point of Interconnection" means the point of delivery of Energy and/or Capacity supplied by the bidder to the Company, where the facilities owned by the bidder interconnect with the facilities owned or to be owned by the Company. The bidder shall own and maintain the facilities from the Generating Facility to the Point of Interconnection. The Company shall own and maintain the facilities from the Point of Interconnection to the Company's System (see examples given in Attachment A). The Point of Interconnection will be identified in the IRS.
- o. "PPA" means a power purchase agreement or contract by the Company to purchase firm capacity, energy, or both.

HAWAIIAN ELECTRIC COMPANY, INC.

RULE NO. 19 - Continued

Interconnection and Transmission Upgrades

- p. "Renewable Energy Facility" means a Generating Facility that generates electricity using renewable energy as the source.
- q. "RFP" means a written request for proposal issued by the Company to solicit bids from interested third-parties, and where applicable from the Company or its affiliate, to supply a future generation resource or a block of generation resources to the Company pursuant to a competitive bidding process.
- r. "Subtransmission System" means all electrical wires, equipment, and other facilities at the subtransmission voltage levels (such as 46kV, 35kV, or 23kV) owned or provided by the Company, through which the utility provides electrical service to its customers.
- s. "Supervisory Control" means remote monitoring and/or control of a Generating Facility's power output and interrupting device status by means of a communication channel that is acceptable to the Company. For Generating Facilities intending to export power with an aggregate export capacity greater than 250kW, computerized supervisory control may be required to ensure the safety of working personnel and prompt response to system abnormalities in case of islanding of the Generating Facility. The Company shall determine the need for supervisory control based upon the results of the initial technical screening and/or IRS. Supervisory control shall include at a minimum monitoring of: (a) gross generation by the Generating Facility; (b) feedback of Watts, Vars, WattHours, current and voltage; (c) Vars furnished by the utility; and (d) status of the interrupting device. In addition, the supervisory control will allow the Company to trip the interrupting device during emergency conditions. Monitoring will be performed by system dispatchers or operators at the Company's control center.
- t. "System Benefit" means a material increase in power flow capability or in the reliability of the Company's electrical system from a system-wide perspective.
- u. "System Upgrades" means improvements made to the Company's System, other than the Interconnection Facilities, required to provide reliable and safe operation of, and power quality on, the Company's System (in accordance with applicable provisions of the Commission's General Order No. 7, Company tariffs, operational practices and planning criteria) when the Generation Facility is interconnected with the Company's System (see Attachment A). Such improvements may include, but are not limited to, new transmission or distribution lines, reconstruction or reconductoring of existing lines, circuit breakers, switches, transformers, buses, protective devices, communications, and substation equipment and facilities.

HAWAIIAN ELECTRIC COMPANY, INC.

RULE NO. 19 - Continued

Interconnection and Transmission Upgrades

v. "Transmission System" means all electrical wires, equipment, and other facilities at the transmission voltage levels (such as 138kV or 69kV) owned or provided by the utility, through which the utility provides electrical service to its customers.

2. Application of Tariff

This Tariff shall apply to an RFP issued pursuant to the Framework and Interconnection Requirement Studies arising from the RFP process. In the event that there is a conflict between any provision of this Tariff and that of an RFP issued pursuant to the Framework and reviewed by the Commission in accordance with Sections III.B.2 and IV.B.6.e. of the Framework, the provisions of the RFP shall prevail. The terms and conditions established in a PPA arising from the RFP and approved by the Commission shall ultimately control over the requirements and terms of both this Tariff and the RFP.

3. Independent Observer

As established in the Framework, the duties and responsibilities of an Independent Observer (IO) include, among other duties and responsibilities, reviewing and monitoring the Company's communications, methods, and implementation of this Tariff, the RFP and related IRS processes.

B. INTERCONNECTION STUDY PROCESS FOR COMPETITIVE BIDDING

1. RFP Package Data -- available to all prospective bidders.

RFP packages issued by the Company shall contain general and regional system information to provide prospective bidders with high level guidance relating to the Company's existing transmission infrastructure. For example, RFP packages may include information in the form of an island map with areas of the Transmission System identified that are at or near their loading limits to provide high level guidance to bidders on areas of the island with transmission constraints. These constraints may include "load pockets", which are load-driven transmission constraints as well as areas of generation-driven transmission constraints. Because transmission impacts are to a large extent specific to the characteristics of supply-side proposals, definitive transmission information cannot be provided in these maps. Detailed geographic maps of the transmission system may not be part of this information due to security concerns. Rather, a map of the island with areas of the map shaded to identify areas (rather than circuits) of transmission constraints, may be provided.

HAWAIIAN ELECTRIC COMPANY, INC.

RULE NO. 19 - Continued

Interconnection and Transmission Upgrades

In addition, the RFP shall include applicable transmission planning criteria that will be used in the determination of interconnection requirements and potential Transmission System impacts. The information in the bid package will provide bidders with information (a) that should help in the selection of the proposed project's characteristics, including project site, project size, and project mode of operation, and (b) to estimate the interconnection requirements associated with their Generating Facilities and the opportunity to reflect the costs of the interconnection requirements in their bids.

2. Information Requests During Bidding Process - available to all prospective bidders.

During the bidding process, if a prospective bidder requires clarification or additional technical or operational information pertaining to the Company's System, a written request with specific questions may be submitted to the Company in accordance with the requirements set forth in the RFP. The written request, specific questions, and written Company response will be provided to all bidders.

3. RFP Requirements and Threshold Criteria Screening - evaluation performed on all bids received

Each bid received will be reviewed to ensure that it satisfies all of the RFP and threshold criteria requirements. The Company will determine whether each bid conforms to the specified RFP requirements and meets the minimum threshold criteria. Applicable performance standards may be part of the threshold criteria. These performance standards may vary depending upon factors such as the size of the generating resource(s) being acquired in the RFP, the Company's ability to dispatch the Generating Facility, the operational status (e.g., as-available vs. firm) of the Generating Facility, and the fuel type of the Generating Facility (e.g., run-of-the-river hydro may have different performance standards from wind power).

4. High Level Evaluation -- performed on all bids that pass threshold screening in RFP process
 - a. All bids which pass the threshold screening in the RFP process will undergo a high level evaluation consistent with the requirements identified in the RFP, which will focus primarily on basic steady-state analyses (e.g., identifying thermal line impacts, voltage impacts, and any obvious "fatal flaws").

HAWAIIAN ELECTRIC COMPANY, INC.

RULE NO. 19 - Continued

Interconnection and Transmission Upgrades

- b. For each bid, a high level estimate of the costs of Interconnection Facilities and required System Upgrades will be developed based solely on the high level evaluation identified in Section B.4.a. of this Tariff and on unitized cost estimates (e.g., \$/mile for 138kV line, \$/transformer).
 - c. Results of the high level evaluation and high level estimate of the costs of Interconnection Facilities and required System Upgrades will be factored into the determination of which bids make the short list based on the requirements specified in the RFP.
 - d. Basic curtailment analysis of the proposed Generating Facility and related impacts to operations of existing Generating Facilities may also be factored into the determination of which bids make the short list based on the requirements specified in the RFP.
5. Full Interconnection Requirements Study - performed only on short list bids.
- a. An IRS shall be performed only for bid(s) that have met the RFP requirements, passed the threshold criteria, and made the short list, or as otherwise specified in the RFP.
 - b. An IRS would be performed either serially starting with the bid evaluated as the most competitive at the point of the evaluation process, then proceeding to the next most competitive bid on the short list or in parallel on all or some of the short list bidders simultaneously. The determination of whether or not IRS work is to be performed serially, in parallel, or a combination of the two will be based upon factors such as resource availability, number of short list bids, RFP schedule, and relative competitiveness of one bid to others, and the availability of all information and data from bidders necessary to perform the IRS work
 - c. The Company may if practicable "bundle" IRS work for multiple short list bids into a single IRS if the bids are, among other factors, technically, operationally and geographically (e.g., size, location, technology, timing, operating characteristics, etc.) identical or sufficiently similar to each other.
 - d. The results of the IRS, including identified Interconnection Facilities, System Upgrades, Point of Interconnection, and Grid Connection Point, will be provided to the bidder.
 - e. Bidders shall be responsible for incorporating the costs of their Interconnection Facilities into their bids. The RFP may provide bidders with an opportunity to revise their pricing proposals under certain circumstances. Any pricing change, if permitted under the terms of the RFP, will prompt a re-evaluation of short list bidders in the selection of the winning bid as provided for in the RFP.

HAWAIIAN ELECTRIC COMPANY, INC.

RULE NO. 19 - Continued

Interconnection and Transmission Upgrades

- f. The Company may perform the analyses included in the IRS, or the IRS or parts of the IRS may be contracted to an outside consultant specializing in such analyses for complex situations or in situations where the Company does not have available resources to conduct the analyses in a time frame agreeable to the Company.
- g. The scope and cost of the IRS will depend on the complexity of the Company's System and Generating Facility that must be modeled, and the degree to which the Generating Facility will affect the Company's System.
- h. The bidder will be responsible for the cost of the IRS (or such lesser amount as the Company may specify to facilitate the processing of interconnection requests for similarly situated facilities) to be performed in order to evaluate the impacts of the Generating Facility's interconnection to the Company's System.

C. INTERCONNECTION COST AND SYSTEM UPGRADE COST ALLOCATION FOR COMPETITIVE BIDDING

- 1. The bidder shall be responsible for the cost of Interconnection Facilities and shall be responsible for the installation and maintenance of Interconnection Facilities from the Generating Facility to the Point of Interconnection, unless otherwise specified in the RFP.
- 2. Interconnection Facilities from the Generating Facility to the Point of Interconnection shall be built by the bidder, unless the Company agrees otherwise.
- 3. Interconnection Facilities from the Point of Interconnection to the Grid Connection Point shall be built by the Company and paid for by the bidder, unless the Company agrees or determines otherwise. The Company may elect to include Betterments to Interconnection Facilities from the Point of Interconnection to the Grid Connection Point, and such Betterments shall be paid for by the Company. The cost of Betterments to such Interconnection Facilities will not be considered in the bid evaluations. The bidder shall acquire the necessary land and easements for Interconnection Facilities from the Point of Interconnection to the Grid Connection Point, unless the Company agrees otherwise. Interconnection Facilities from the Point of Interconnection to the Grid Connection Point, if built by the bidder, shall be transferred to the Company upon completion, along with the necessary land rights and easements.

HAWAIIAN ELECTRIC COMPANY, INC.

RULE NO. 19 - Continued

Interconnection and Transmission Upgrades

4. The Company shall install and maintain the identified System Upgrades arising from the interconnection of the Generating Facility and shall be responsible for the cost of such System Upgrades.
 - a. The Company's cost for System Upgrades will be considered as a factor in the bid evaluations.
 - b. The degree to which the System Upgrades provide System Benefits and/or Betterments will be considered in the bid evaluations.
5. Standards and Interconnection Agreements
 - a. Interconnection Facilities and System Upgrades owned or to be owned by the Company shall be constructed in accordance with the Company's applicable standards and in accordance with the PPA or the Interconnection Agreement, if there is a separate Interconnection Agreement.
 - b. Generating Facilities and Interconnection Facilities owned by the bidder shall be constructed in accordance with applicable State and County code requirements and in accordance with the PPA or the Interconnection Agreement, if there is a separate Interconnection Agreement.
 - c. The bidder's Generating Facility may be interconnected and operated in parallel with the Company's System in accordance with the terms and conditions of the PPA between the Company and the bidder, and/or the terms and conditions of an Interconnection Agreement between the Company and the bidder, if there is a separate Interconnection Agreement.
 - d. The bidder will be required to furnish, install, operate, and maintain suitable and sufficient equipment, to maintain adequate records, and to follow such operating procedures, as may be specified by the Company to protect the Company's System from damage resulting from the parallel operation of the Seller's Facility, including the equipment, records and operating procedures more fully described in the PPA and/or Interconnection Agreement, if there is a separate Interconnection Agreement.
 - e. Interconnection Facilities shall be designed, installed operated and maintained in accordance with good interconnection practice. The objectives of good interconnection practice include, but are not limited to,
 1. Safety - To protect the safety of utility personnel, utility customers, and the public.

HAWAIIAN ELECTRIC COMPANY, INC.

RULE NO. 19 - Continued

Interconnection and Transmission Upgrades

2. Reliability - To maintain the reliability of the utility system for all utility customers.
 3. Power Quality - To provide for acceptable power quality and voltage regulation on the utility system and for all utility customers.
 4. Restoration - To facilitate restoration of power on the utility system.
 5. Protect Utility and Customer Equipment - To protect utility and customer equipment during steady state and faulted system operating conditions.
 6. Protect Generating Facilities - To protect generating facilities from operation of utility protective and voltage regulation equipment.
 7. Utility System Overcurrent Devices - To maintain proper operation of the utility system's overcurrent protection equipment.
 8. Utility System Operating Efficiency - To ensure operation at appropriate power factors and minimize system losses.
- f. The bidder shall obtain, at its expense, any and all authorizations, approvals, permits, and licenses required for the construction and operation of its Generating Facility and the interconnection of its Generating Facility with the Company's System, including but not limited to environmental permits, building permits, rights of way, or easements.
 - g. Where any Company-owned Interconnection Facilities are to be located on the site of the bidder's Generating Facility, the bidder shall provide, at no expense to the Company, a location and access acceptable to the Company for all such facilities.
6. Renewable Energy Facilities
- a. In its IRP process, the Company may propose System Upgrades, to be paid for, owned and maintained by the utility, to encourage the development of Renewable Energy Facilities.
 - b. In its IRP process, the Company may propose to pay for Interconnection Facilities between the Point of Interconnection and the Grid Connection Point, in order to encourage the development of Renewable Energy Facilities.

HAWAIIAN ELECTRIC COMPANY, INC.

RULE NO. 19 - Continued
Interconnection and Transmission Upgrades

Attachment A

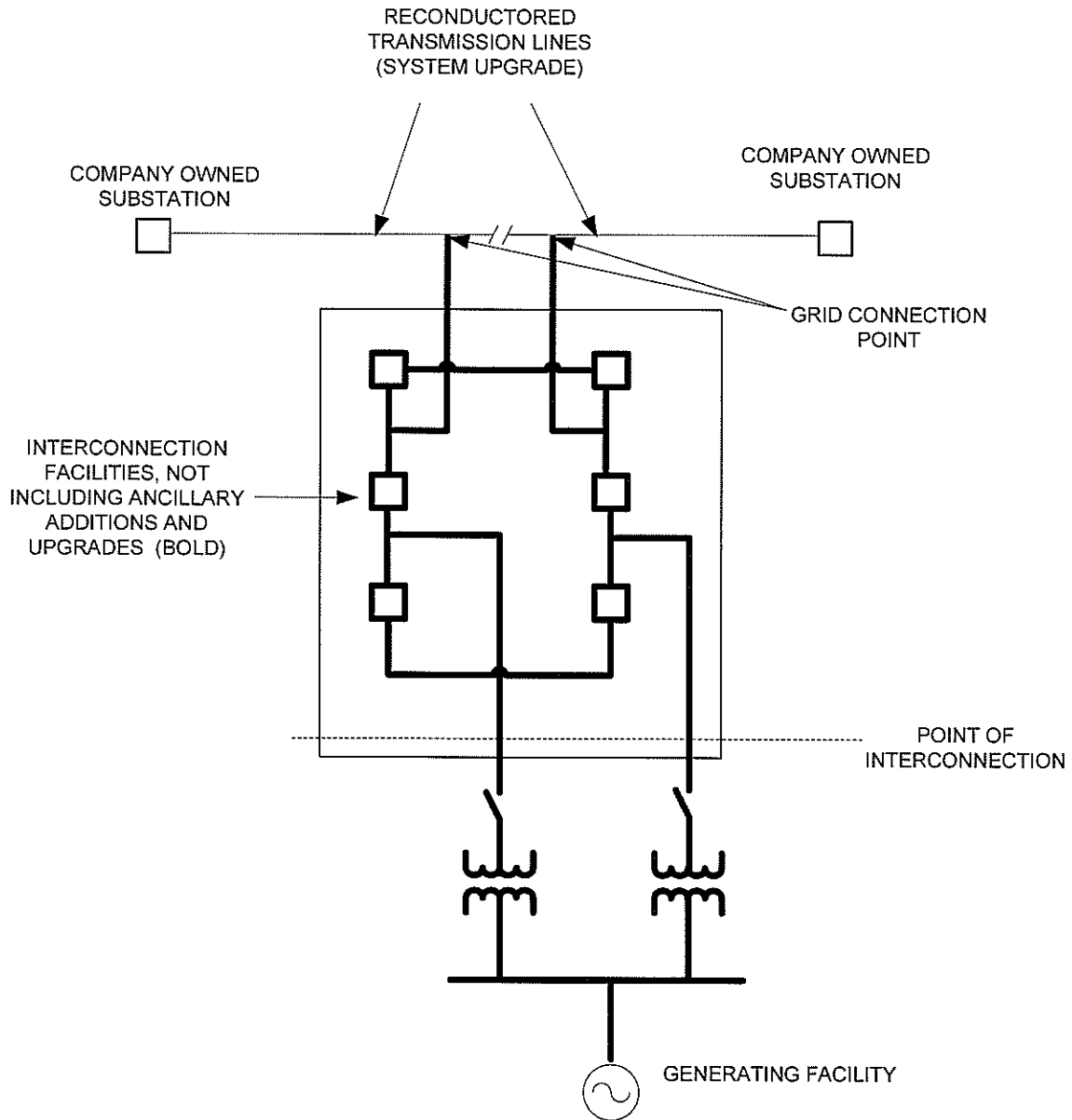

HAWAIIAN ELECTRIC COMPANY, INC.

DRAFT REQUEST FOR PROPOSALS
FOR
VARIABLE RENEWABLE DISPATCHABLE GENERATION

ISLAND OF O‘AHU

FEBRUARY 2, 2018

Docket No. 2017-0352

Appendix K – (Reserved)



**Hawaiian
Electric**

DRAFT REQUEST FOR PROPOSALS
FOR
VARIABLE RENEWABLE DISPATCHABLE GENERATION

ISLAND OF O‘AHU

FEBRUARY 2, 2018

Docket No. 2017-0352

Appendix L – Selection Criteria



**Hawaiian
Electric**

**APPENDIX L
SELECTION CRITERIA
VARIABLE RENEWABLE DISPATCHABLE GENERATION
ISLAND OF O‘AHU**

A. Introduction

This document outlines the evaluation and selection process the Company will implement for reviewing, evaluating, and selecting resources at each stage in the evaluation process. The document outlines the Company’s process for receiving Proposals, conducting the initial Eligibility and Threshold assessment and the bid evaluation process, ultimately resulting in selection of the Short List and Final Award Group.

The Company will employ a multi-step evaluation process for the Variable Renewable Dispatchable Generation RFP. The Proposals will be subject to a consistent and defined review, evaluation and selection process. Upon receipt of the Proposals, the Company will ensure that the Proposals meet the Eligibility requirements, and if met, will review the Proposals to ensure that the Threshold Requirements are met. Proposals that have successfully passed the Eligibility and Threshold criteria assessments will then enter a two-step Proposal evaluation process. The process includes the Initial Evaluation selection of a Short List, followed by the opportunity for Short-Listed Proposals to provide Best and Final Offers, and then a Detailed Evaluation process to arrive at a Final Award Group.

B. Receipt of Proposals

Proposals must be submitted through the PowerAdvocate Platform by the proposal close date specified in Chapter 3 of the RFP. The PowerAdvocate Platform will not accept the submission of late information for this event.

Figure 1 below from the RFP Document illustrates the complete evaluation process.

Figure 1 – Evaluation Workflow

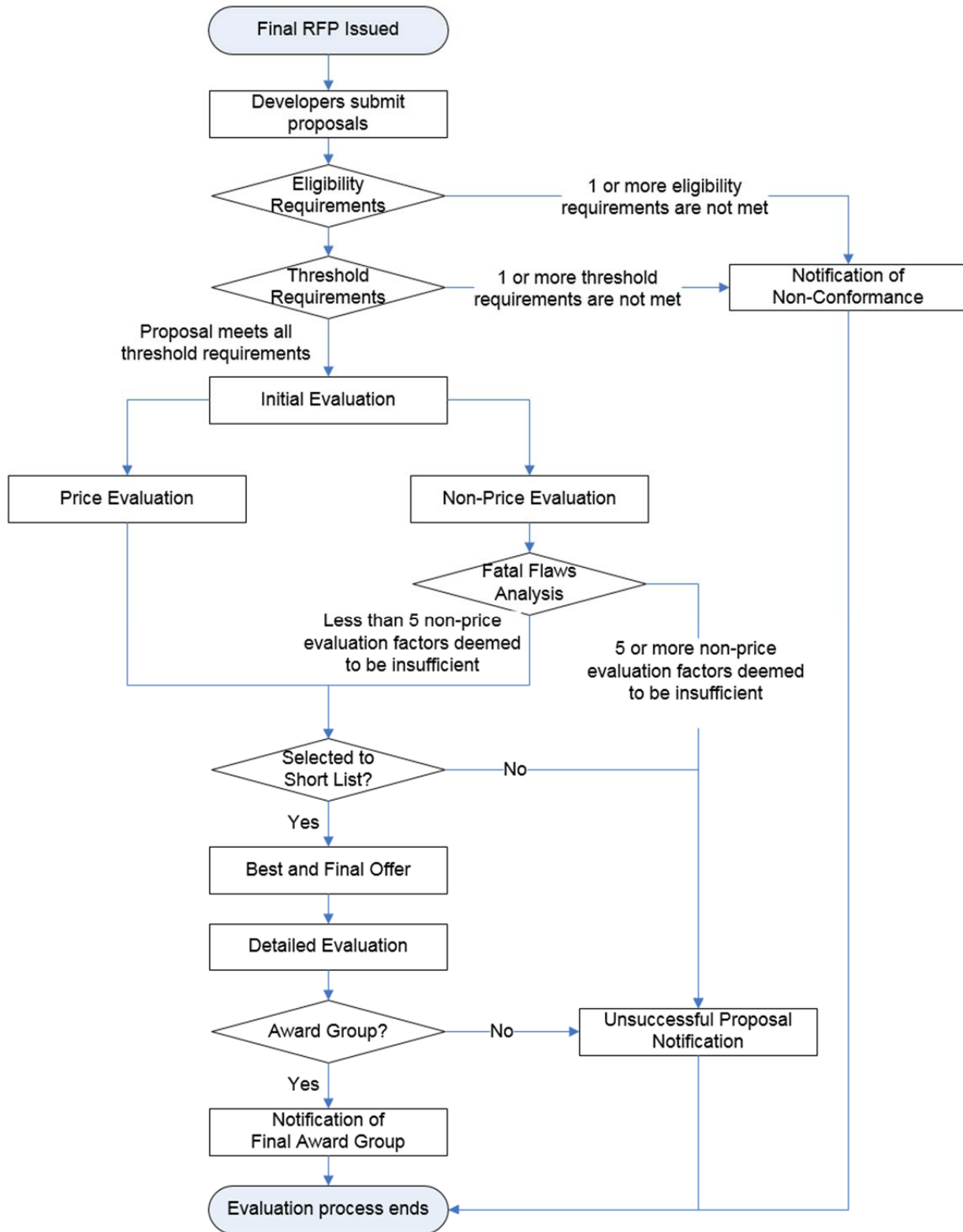

C. Eligibility Requirements Assessment

The Company RFP team, with oversight from the Independent Observer, will begin a review of the Proposals to determine if the Proposals meet the Eligibility Requirements. If a Proposal is deemed not to meet the Eligibility Requirements, the reasons for such failure will be identified and documented. From Section 4.2 in the RFP:

- The Proposal must be received on time via the PowerAdvocate Platform.
- The non-refundable Proposal Fee must be received on time.
- The Proposal must not contain material omissions.
- The Proposal must be signed and certified by an officer or other authorized person of the Proposer.
- There must not have been illegal or undue attempts by or on behalf of the Proposer or others to influence the Proposal review process.
- The Proposal must not contain misrepresentations.
- The Proposers must fully execute the agreements or other documents required pursuant to this RFP.
- The Proposer must provide a certificate of good standing from the State of Hawai'i Department of Commerce and Consumer Affairs.
- The Proposer must provide Federal and State tax clearance certificates for the Proposer.
- The Proposal must not be contingent upon changes to existing county, state or federal laws or regulations.
- The proposed Project must be located on the Island of O'ahu.
- No single point of failure from the Facility shall result in a decrease in net electrical output greater than 135 MW.
- Storage systems that are coupled with a Facility must only be charged by the renewable energy generated by the Facility and not delivered from the grid.

The Company in coordination with the Independent Observer will determine if a Proposer is allowed to cure any aspect of its Proposal or whether the Proposal would be eliminated based on failure to meet Eligibility Requirements.¹ If a Proposer is provided the opportunity to cure any aspect of its Proposal, the Proposer shall be given three (3) business days to cure from the date of notification to cure.

¹ As a general rule, if a Proposer does not include a requested document or may inadvertently exclude minor information or provides inconsistencies in its information, it may be given a chance to cure the inadequacies. If a Proposer does not include significant sections of its Proposal and providing the Proposer with the opportunity to cure is deemed a benefit to that Proposer at the expense of the competitors it could be classified as non-conforming and eliminated for failure to meet the eligibility requirements.

D. Threshold Requirement Assessment

Proposals that meet all the Eligibility Requirements will then be evaluated to determine compliance with the Threshold Requirements, which have been designed to screen out Proposals that are insufficiently developed, lack demonstrated technology, or will impose unacceptable execution risk for the Company. Proposals that fail to meet a Threshold Requirement will be eliminated from further consideration upon concurrence with the Independent Observer. The Threshold Requirements for this RFP are the following:

- **Site Control:** The Proposal must demonstrate that the Proposer has Site Control for all real property required for the successful implementation of a specific Proposal at a Site not controlled by the Company, including any Interconnection Facilities for which the Proposer is responsible. If the Threshold Requirement for Site Control is met, Site Control will be further evaluated as a part of the Non-Price evaluation.
- **Performance Standards:** The proposed Facility must be able to meet the attributes identified in this RFP and the Performance Standards identified in the Model Renewable Dispatchable Generation PPA (“Model PPA”).
- **Proven Technology:** The Company will only consider Proposals utilizing technologies that have been successfully reached commercial operations in multiple commercial applications at the scale being proposed.
- **Experience of the Proposer:** The Proposer, its affiliated companies, partners, and/or contractors and consultants on the Proposer’s Project team must have experience in the development and operation of at least one (1) electricity generation project through the commercial operations stage where such project was of a similar in size (i.e., no less than half of the size of the project being proposed in response to this RFP), scope, technology, and structure to the Project being proposed by Proposer.
- **Credit/Collateral Requirements:** Proposers shall agree to post Development Period Security and Operating Period Security as described in Section 3.13 of the RFP.
- **Available Transmission Circuit Capacity:** The output capacity of the Proposed project must not exceed the available capacity of the transmission circuit to which it will interconnect.
- **Financial Viability of Proposer:** Proposers must provide a basic financial plan for the project with details on the sources of debt and equity, capital structure, etc.
- **Guaranteed Commercial Operations Date:** The project’s Guaranteed Commercial Operations Date must be no later than December 31, 2022.

If necessary, during the Eligibility and Threshold evaluation, the Company may identify specific follow-up questions for each Proposer to ensure that a complete and thorough evaluation can then be undertaken. Proposers will have up to three (3) business days to complete and submit their responses from the date of the request by the Company. Proposals that fail to meet a Threshold Requirement will be eliminated from further consideration upon concurrence with the Independent Observer.

E. Initial Evaluation Resulting in Selection of the Short List

Proposals that meet both the Eligibility and Threshold requirements will then be subject to a price and non-price assessment. Two teams have been established to undertake the bid evaluation process: (1) the Price Evaluation Team and (2) Non-Price Evaluation Team. Each team will work independently and not divulge the scoring or ranking of Proposals to the other team.

The results of the price and non-price analysis will be a relative ranking and scoring of all eligible proposals within technology buckets where the inclusion of storage will be treated as a separate technology bucket (i.e., Solar PV, Solar PV plus energy storage, wind, wind plus storage, etc.). For the short-listing process, price-related criteria will be weighed at 60% of the total ranking and non-price at 40%. The Company's objective for the Short List selection process is to identify and select proposals that are low cost and viable projects, as defined by the price and non-price weights at this stage in the process.

Price Evaluation

For the initial price analysis, an equivalent energy price (Levelized \$/MWh) will be calculated for each Proposal based on information provided in the Proposal including the Lump Sum Payment (\$/month), Energy Payment Price (\$/MWh), and the Net Energy Potential ("NEP") RFP Projection (MWh) information defined in Section 3.11.2 of the RFP.

In order to fairly evaluate Proposals with different technologies and characteristics while using an equivalent energy price in Levelized \$/MWh at this stage in the evaluation, the Company will group Proposals being evaluated into technology buckets.² The Company will then conduct the comparative evaluation and award evaluation points to Proposals within each technology bucket in accordance with the relative ranking based on levelized price per MWh. The Proposal with the lowest levelized price in each technology bucket will receive 600 points and all other proposals in that technology bucket will receive points based on the percentage increase in the Proposal's levelized price when compared to the lowest levelized price in the same technology

² The process of grouping proposals into technology buckets rather than merely calculating levelized costs for each proposal and ranking accordingly has several advantages for such a solicitation process with multiple technology options. First, levelized cost analysis is a reasonable screening tool that can be used effectively to evaluate "like" or similar proposals or technologies with similar characteristics. Second, ranking and selecting proposals in technology buckets ensures that all technologies will have the opportunity to compete during the final evaluation process when the implications of each proposal on the utility system costs are evaluated. Third, effectively comparing technologies or proposals with different operating characteristics is challenging and does not provide reasonable results when using a levelized cost methodology. For example, in All-Source RFPs, it is not reasonable or effective to compare a Demand-Response product that offers 100 hours of operations relative to a combined cycle project that can operate at a very high capacity factor. The levelized costs of each option will be dependent on the capacity factor of each option rather than a "one size fits all" result. The bucketing process, which allows for comparison of like resources, therefore eliminates the potential shortcomings associated with the use of levelized costs as a screening tool for comparing different projects in such a process.

bucket. For example, if Proposal B's levelized price is 10% higher than the lowest cost Proposal (i.e., Proposal A), the lowest cost Proposal will be awarded 600 price points, while Proposal B, which is 10% higher in price will be awarded 90% of the points or 540 points. The result of this assessment will be a ranking and scoring of each proposal within each technology bucket.

Non-Price Evaluation

For the non-price analysis, each Proposal will be evaluated based on each of the eleven (11) non-price criteria categories set forth in Appendix L, with each non-price criteria category in Appendix L weighted equally. The non-price criteria categories include:

1. Community Outreach and Engagement
2. Cultural Resource Impacts
3. Environmental Review and Permitting
4. Experience and Qualifications
5. Financial Strength and Financing Plan
6. State of Project Development and Schedule
7. Site Control
8. Environmental Compliance/Impacts
9. O&M Plan
10. Model PPA Contract Exceptions
11. Financial Compliance

Proposals will be evaluated using the following non-price criteria to assess their merit in the general areas of project development feasibility and operational viability.

Community Outreach and Engagement – Gaining community support is an important part of a project's viability and success. Proposals will be evaluated on their plan to inform the neighboring community of the project, incorporate changes based on community input, and any community outreach and engagement efforts that have been performed to date. At a minimum, proposals should include a community outreach plan that describes the proposer's intentions to work with the neighboring community to provide project information during project development and construction and to address any local and community issues that may arise. Additional preference will be given to proposers who have already established contacts to work with the local community and have proposed a community benefits package. Preference will also be given to developers and/or their selected community consultant that have successfully worked with one or more Hawai'i communities for project development (energy or projects with similar community issues). This criteria is aligned with the Companies' new community engagement process whereby all developers will be required to engage in community outreach prior to signing a PPA with the Companies. This process is also outlined in the RFP document.

Cultural Resource Impacts – Projects should be mindful of their potential impact to cultural resources. Parties should, at a minimum, identify (1) valued cultural, historical, or natural resources in the area in question, including the extent to which traditional and customary native Hawaiian rights are exercised in the area; (2) the extent to which those resources – including traditional and customary native Hawaiian rights – will be affected or impaired by the proposed action; and (3) the feasible action, if any, to be taken to reasonably protect native Hawaiian rights if they are found to exist. Proposals will be evaluated on their plan to assess and mitigate their impact to cultural resources and any assessments that have been conducted to date. At a minimum, proposers should have already contracted with a consultant with expertise in this field to begin a cultural impact assessment for the project. Additional preference will be given to Proposals that are further along in the assessment process and are able to provide a mitigation/action plan or are able to provide a date for when a mitigation/action plan will be available that addresses any identified cultural resource issues.

Environmental Review and Permitting Plan – Completing any necessary environmental review and obtaining the required permitting in a timely manner is important to meeting construction schedules. Proposals will be evaluated on their plan to identify, apply for, and secure the required permits for the project, any permitting activity that has been completed to date, and the degree of certainty offered by the Proposer in securing the necessary permits. At a minimum, proposers should have identified all major permits and approvals required and have a preliminary plan for securing the permits. Additional preference will be given to Proposals that are able to provide a greater degree of certainty that its plan to secure the required permits is realistic and achievable, or have already received all or a majority of the required permits.

Experience and Qualifications – Developers with a demonstrated ability to construct and interconnect projects to the Company grid can reasonably be expected to be able to successfully complete a project with a higher level of confidence than those without any prior experience. Therefore, proposals will be evaluated based on the experience of the Developer in constructing, interconnecting and operating projects through the commercial operations stage of similar size (i.e., no less than half of the size of the project being proposed in response to this RFP), scope and technology. At a minimum, the proposer and its team should have experience with developing at least one project of a similar size and technology to the one being proposed. Additional preference will be given to proposers with experience in successfully developing, financing constructing, and operating multiple projects that are similar to the one being proposed and/or that have prior experience developing a project in Hawai‘i.

Financial Strength and Financing Plan – This criterion addresses the comprehensiveness and reasonableness of the financial plan for the project as well as assesses the financial strength and capability of the proposer to develop the project. A

complete financial plan addresses the following issues: project ownership, capital cost and capital structure, sources of debt and equity, and evidence that the project is financeable. The financial strength of proposers or their credit support providers will be considered, including their credit ratings. At a minimum, the Proposal should include a basic financial plan for the project covering the sources of debt and equity, capital structure, etc. and provide evidence of general support for the project financing. The financing participants are expected to be reasonably strong financially. Additional preference will be given to financial plans that are more comprehensive and also achievable, provide stronger evidence (for example, a letter from a financial institution or bank) that the project is financeable, and that can demonstrate that the proposer has the capability and financial strength to develop and finance the project. Developers and their sources of capital that have investment grade credit ratings from a reputable credit rating agency (S&P, Moody's, Fitch) will also be given preference, with those that have higher credit ratings ranked higher. This criterion will also look at the high-level project costs set forth in the Proposal including: costs for equipment, construction, engineering, Seller-Owned Interconnection Facilities, Company-Owned Interconnection Facilities, Land, and Annual O&M and the reasonableness of such costs. Project costs that do not appear reasonable for a project of the size proposed may result in a lower ranking for this criterion if the Company reasonably determines that the cost information is unrealistic based on prior experience in the market which may result in a risk that the Project can be built on time and for the price proposed by the Proposer. The Company reserves the right to discuss any cost and financial information with a Proposer to ensure the information provided is accurate and correct.

State of Project Development and Schedule – Projects that are further along in development generally have lower project execution risk and a greater probability of being able to be successfully placed into service prior to the Commercial Operations Date required to be no later than December 31, 2022 and are more likely to be able to pass along tax credit savings to customers. At a minimum, projects should be able to demonstrate that there is a reasonable chance that the project will be able to meet the 2019 investment tax credit safe harbor and a commercial operations date no later than December 31, 2022. Additional preference will be given to proposals that are able to demonstrate via a detailed critical path schedule, including identifying adequate slack time, that there is a high likelihood that the project will be able to meet the 2019 investment tax credit safe harbor and commercial operations by the end of 2022.

Site Control – This criterion relates to the status of site ownership and control by the project sponsor as well as the maturity of site control. In addition, developmental requirements and restrictions such as zoning of the site and the status of easements are considered. At a minimum, the proposer should have executed a letter of intent to develop the site and have a reasonable plan for addressing zoning, rights of ways, and

easements. Additional preference will be given to Proposers who: (1) own the site or have executed an agreement or option to purchase or lease the site, (2) propose a site that is currently appropriately zoned, or (3) have obtained or have letters of intent to obtain any required rights of ways and easements. It is anticipated and acceptable that there may be non-exclusive agreements or options for a particular site which would be contingent upon selection of projects.

Environmental Compliance / Impacts – This criterion relates to the potential environmental impacts associated with each project, the quality of the plan offered by the proposer to mitigate and manage any environmental impacts (including any pre-existing environmental conditions), and the plan of Proposers to remain in environmental compliance over the term of the contract. These impacts are reflected on a technology specific basis. At a minimum, proposed projects should be expected to have a minimal impact for most environmental areas and proposals should provide a preliminary plan to mitigate the identified impacts to remain in environmental compliance which should not significantly affect the project timeline. Additional preference will be given to proposals that provide a more detailed plan as well as those that have already proactively taken steps to mitigate environmental impacts.

O&M Plan – Operations and maintenance is an important aspect of project operations. This is especially important in the context of the new Model PPA structure, which relies on the continued performance of the Facility in exchange for fixed monthly payments. Proposals will be evaluated on their plan for operating and maintaining the Facility throughout the contract term including the status of any agreements with an O&M provider, the reasonableness of the O&M funding levels and mechanism, staffing levels, as well as any design plans that identify and incorporate features to ensure appropriate reliability is built into the project. At a minimum, proposals should include a reasonable O&M plan that identifies expected funding and staffing levels. Additional preference will be given to proposals that provide a more comprehensive plan or those that have identified a potential O&M provider or have already executed a minimum letter of intent with a reputable O&M provider.

Model PPA Contract Exceptions – Proposers may propose modifications to the Model PPA, including modifications that are intended to address a project's specific technology and operating characteristics. However, in general, Proposers are encouraged to accept the contract terms identified in the Model PPA where possible in order to expedite the overall RFP process and potential PPA negotiations. Proposers who elect to propose modifications to the Model PPA shall provide a red-line version of the Model PPA with their requested modifications as a component of their Proposals and shall also provide a detailed explanation and supporting rationale for each of the proposed modifications to the Model PPA in order to enable the Company and Independent Observer to evaluate the

impact that the proposed modifications will have on the overall risk assessment associated with the evaluation of each Proposal.

Financial Compliance – The proposed Project must not cause the Company to be subject to consolidation and capital lease treatment as set forth, respectively, in Financial Accounting Standards Board (“FASB”) Accounting Standards Codification Topic 810, Consolidation (“ASC 810”) and 840, Leases (“ASC 840”) as issued and amended from time to time by FASB, nor lease treatment as set forth in FASB Accounting Standards Codification 842, Leases, effective January 1, 2019 (“FASB ASC 842”), as issued and amended from time to time by FASB. At a minimum, Proposers are required to state to the best of their knowledge, with supporting information to allow the Company to verify such conclusion, that the proposal will not: (1) trigger a capital lease accounting treatment under FASB ASC 840; (2) trigger lease treatment under FASB ASC 842; or (3) result in the Seller under the PPA being a Variable Interest Entity (“VIE”) that would trigger consolidation of the Sellers’s finances on to the Company’s financial statements under FASB ASC 810. The Company will perform a preliminary consolidation and capital lease assessment based on the Proposals received. If the Company believes that the Proposal may be subject to such treatment, it will inform the Proposer and either may request additional information or work with the Proposer to structure its agreement to avoid the lease and consolidation treatment. The Company reserves the right to allow a Proposal to proceed through the evaluation process through selection of the Short List and work with the Proposer on this issue during Model PPA negotiations. Projects that appear less likely to cause lease and/or consolidation treatment based on Company’s assessment will be rated more favorably. A final consolidation and capital lease assessment will be performed prior to execution of a PPA. Final analysis will focus on PPA revisions or proposal changes which, for lease consideration, could influence the right to direct the use of the project asset over the PPA term, and for consolidation issues, revisions or changes that could potentially affect determination of the primary beneficiary of the contractual arrangement, e.g., having or affecting the ability to direct activities that significantly impact economic performance of the project asset, such as the ability to direct or control operations and maintenance activities.

Each of the eleven non-price criteria will be scored on a scale of 1 (poor) to 5 (highly preferable). The total non-price score will be the sum of the scores for each of the eleven individual non-price criteria.

The Company will then award non-price evaluation points in accordance with the relative ranking of scores within each technology bucket. The Proposal in each technology bucket with the highest total non-price score will receive 400 points and all other Proposals within that technology bucket will receive points equal to the Proposal’s score divided by the top score, multiplied by 400.

During the non-price criteria evaluation, a fatal flaw analysis will also be conducted such that any Proposal that is deemed to not meet the minimum standards level³ for five (5) or more of the eleven (11) non-price criteria will be disqualified given that any Proposal that has failed to meet the minimum standards of nearly half of the non-price criteria is indicative of the lack of general feasibility and operational viability of a proposed project.

Selection of the Short List

At the conclusion of both the price and non-price analysis, a total score will be calculated for each Proposal using the 60% price-related criteria/40% non-price-related criteria weighting outlined above. The price and non-price analysis, and the summation of both price and non-price scores described above, will result in a ranking of proposals within each technology bucket.

The Company will select a Short List from the highest scoring Proposals from across the different technology buckets. While the Company has retained flexibility in the RFP to determine how many projects to advance to the Short List, the Company currently intends to select up to the number of projects targeted, plus one, in the RFP from each technology bucket for the Short List. For example, the O‘ahu Variable RFP is targeting two (2) projects in Stage 1. Thus, up to three (2+1=3) projects from each technology bucket will be selected to the Short List.⁴ The Companies have the right in consultation with the Independent Observer to select more projects to the Short List, if for example, significantly more Proposals are received for one technology as compared to others in response to the RFP.

The following illustrative example n is provided to explain the process from the Initial Evaluation stage to to the Short List stage:

- There are thirteen proposals, four PV projects (#1, #2, #3, #4), four PV+ storage projects (#5, #6, #7, #8), and five wind projects (#9, #10, #11, #12, #13);
- The ranking for each project matches its numbering (e.g., project #1 has a higher total points score than project #2);
- Projects #1, #2 and #3, #5 and #6, and #9 and #10 are all on the same circuit;
- The remaining projects are each on different circuits; and
- The RFP targets two projects to be selected (so up to 2+1=3 projects to be selected to advance from each technology bucket to the Short List).

In this illustration, project #3 would be eliminated because it is on the same circuit with #1 and #2 within its respective bucket. Therefore, the projects selected to advance to the short list are: #1, #2, #4 from the PV bucket; #5, #6, #7 from the PV+ storage bucket; and #9, #10, #11 from the wind bucket for a total of nine projects advancing to the Short List.

³ A score of three (3) is the “meets minimum standards” level that a Proposal must achieve in at least six criteria.

⁴ In cases where the highest scoring Proposals within a technology bucket propose to interconnect to the same circuit, only up to two of the highest scoring Proposals on the same circuit will be kept and all others on that circuit will be eliminated. Thus, within each technology bucket, there will be no more than two projects on the same circuit that become eligible for selection to the Short List.

Proposals that are not included on the Short List will be released from further consideration when the Short List is established.

F. Best and Final Offers and Detailed Evaluation

The Company will solicit a Best and Final Offer from Proposers selected to the Short List. Proposers will have the opportunity to update (downward only) the pricing elements in their Proposals, including the:

- Lump Sum Payment (\$/year) amount
- Energy Payment price (\$/MWh) amount

Proposers will not be allowed to increase their price,⁵ but may elect to maintain the same pricing submitted in their original Proposal. If a Proposer does not modify its Proposal, the original Proposal will be deemed its Best and Final Offer.

The Company will then further evaluate Proposals by assessing the proposed cost of the delivered energy and operating characteristics of the proposed Project. The Company intends to use the PLEXOS model⁶ for this analysis. The evaluation will be based on the Total Net Cost (Costs and Benefits) to the Company of integrating a Proposer's proposed Project onto the Company's system which includes:

1. The cost to dispatch the Project and the energy purchased;
2. The fuel cost savings (benefits) and any other direct savings (IPP savings from dispatchable fossil fuel savings) resulting from the displacement of generation by the proposed Project;
3. The estimated increase (or decrease) in operating cost, if any, incurred by the Company to maintain system reliability;
4. The cost of imputed debt, if applicable.

For conducting this analysis, the Company will replace units in a reference plan with the proposed resource and re-run its resource plan with the specific Short-Listed Proposal.

During the Detailed Evaluation process, the Company may elect to have face-to-face meetings with Proposers to better assess the Proposals and status of the proposed Project(s).

⁵ Proposers will not be allowed to increase the pricing in their Proposals to address interconnection and/or system upgrade costs or for any other reason.

⁶ The PLEXOS Integrated Energy Model software is developed by Energy Exemplar. Refer to their website: www.energyexemplar.com for additional information on the software.

As noted above, the Company will take into account the cost of rebalancing its capital structure resulting from any debt or imputed debt impacts associated with each Proposal (including any costs to be incurred by the Company, as described above, that are necessary in implementing the Proposal). The Company proposes to use the imputed debt methodology published by Standard & Poor's ("S&P") that is applicable to the Proposal being submitted.⁷ S&P views long-term PPAs as creating fixed, debt-like financial obligations that represent substitutes for debt-financed capital investments in generation capacity. By adjusting financial measures to incorporate PPA fixed obligations, greater comparability of utilities that finance and build generation capacity and those that purchase capacity to satisfy new load are achieved.

The Company's RDG PPA proposes a fixed payment. S&P's methodology of imputed debt begins with calculating the present value of total fixed payments over the life of the contracts, using a 7% discount rate. It then determines a risk factor to apply to the contracts to reflect the riskiness to the utility based on the terms of the contract and assurances of cost recovery. The risk factor is applied to the present value of the fixed payments under the contract to calculate the imputed debt (risk factor x present value of fixed contract payments = imputed debt). For resources where the contract price is stated as a single, all-in energy price, S&P has published a revised methodology which calculates the fixed costs for imputed debt purposes based on a proxy capacity charge stated in \$/kW-year for a new peaking unit. While the Company does not expect such projects given the RDG PPA structure, for such projects, the Company would calculate the imputed debt impact based on the current S&P methodology by first determining the approximate monthly cost (capacity x capacity factor x proxy capacity charge/12 months). The Company will then calculate the net present value of the stream of monthly costs over the duration of the PPA term.

The Company proposes to apply a risk factor consistent with guidance from S&P regarding the risk factor that would be applicable to the Company's entering into the particular type of PPA and the cost-recovery mechanism. Under current guidance from S&P, the Company plans to use a risk factor of 25% in light of the power cost adjustment recovery provisions available to PPAs that the Company would expect to enter into pursuant to this RFP. The cost of rebalancing the capital structure for the calculated imputed debt, in order to maintain the Company's target equity/total capitalization ratio will be included in the calculation of the Total Net Cost as indicated above.

⁷ Each Proposal will be evaluated under generally accepted accounting standards, to determine whether or not it is a lease. If the Proposal is deemed to be a lease, it will be evaluated to determine whether it is an operating lease or a capital lease obligation. If the Proposal is deemed a capital lease obligation, the incremental cost of additional common equity to maintain the Company's target equity/total capitalization ratio will be considered in the proposal evaluation. If the Proposal is deemed an operating lease or other off-balance sheet obligation, the Company proposes to use the imputed debt methodology published by Standard & Poor's.

In addition to the above described analysis, during the evaluation and before the Proposals advance to the Final Award Group, the Company will perform load flow analyses to determine if certain Project combinations introduce transmission circuit constraints that will factor into the selection process. This is to address the possibility that even though sufficient line capacity was identified for an individual Project, large Projects on separate transmission circuits that are in close proximity with each other could introduce additional transmission circuit constraints. The Projects selected must not have any additional constraints imposed based on the Load Flow Analysis to advance to the Final Award Group. However, the Company reserves the right, in consultation with the Independent Observer, to allow minor modifications to a Proposal to avoid such additional constraints. If such modification resulted in a reduced size of the facility, the pricing proposed would also need to be revised. Under no circumstances would a Proposer be allowed to increase its price as a result of such minor modification. In addition, the Company will ensure Projects selected as the Final Award Group are not on the same transmission circuit.

In addition, a sensitivity analysis may be performed that considers the Interconnection Costs Savings Rate included in Proposals selected to the Short List in the event that there are Proposals with approximately the same Total Net Cost to the Company in the detailed evaluations. The Company may run additional scenario analyses if requested by the IO and the time and capability exist to run such analyses.

G. Selection of the Final Award Group

Based on the results of the Detailed Evaluation and review of the results with the Independent Observer, the Company will select a Final Award Group from which to begin contract negotiations. The Company intends to select two (2) Projects in this Stage 1 RFP. All Proposers will be notified at this stage of the evaluation process whether their Proposal is included in the Final Award Group.

Selection to the Final Award Group and/or entering into contract negotiations does not guarantee execution of a PPA. Any Project not selected to the Final Award Group may be resubmitted in Stage 2 of this RFP or in a subsequent RFP.

Unless time permits and in consultation with the Independent Observer, after the selection of the Final Award Group, if at any time a project no longer continues, the Company will not seek a replacement project in Stage 1 but will seek the supply of renewable energy from the Stage 2 solicitation process.

DRAFT REQUEST FOR PROPOSALS
FOR
VARIABLE RENEWABLE DISPATCHABLE GENERATION

ISLAND OF O‘AHU

FEBRUARY 2, 2018

Docket No. 2017-0352

Appendix M – Revisions to RDG PPA for Storage



**Hawaiian
Electric**

PPA Revisions to Accommodate Projects that contain Storage

Proposals may contain storage which may be charged during periods when full potential export is not being taken by the Company, and used to provide energy to the Company during periods when source energy is not available. The Company maintains complete dispatch rights over the entire Facility and may dispatch the Facility at any time. Revisions to the RDG PPAs will be necessary for proposals that include storage. Such revisions shall include, but shall not be limited to the following sections of the RDG PPAs.

Section	Revision
Article 2.5 – Availability Factor; Liquidated Damages; Termination Rights	Modify this section to include the energy storage equipment in the calculation of the availability factor, availability benchmark and liquidated damages.
Article 2.6 – Measured Performance Ratio; Liquidated Damages; Termination Rights	Modify this section to include energy storage in the calculation of the performance ratio, performance ratio benchmark and liquidated damages.
Attachment A, Section 5 - Equipment	Add specifications for Energy Storage system.
Attachment B, Section 3 – Performance Standards	
3 (b) (i) – Reactive Amount	Clarify that this section applies to each generator and each energy storage unit.
3 (c) (i) and 3 (c) (ii) – Ramp Rates, 3 (h) – Fault Ride Through, 3 (m) – Frequency Response	Clarify that energy storage is expected to assist in meeting these performance standards
Attachment B, Exhibit B-2	Provide capability curves for generator and energy storage.