

BEFORE THE PUBLIC UTILITIES COMMISSION  
OF THE STATE OF HAWAII

In the Matter of the Requests of )  
 )  
HAWAII ELECTRIC LIGHT COMPANY, INC. )  
 )  
To Institute a Proceeding Relating )  
To Competitive Procurement to )  
Acquire a Battery Energy Storage )  
System in North Kohala. )  
 )  
\_\_\_\_\_ )

DOCKET NO. 2022-0012

ORDER NO. **38195**

OPENING THE DOCKET

BEFORE THE PUBLIC UTILITIES COMMISSION  
OF THE STATE OF HAWAII

In the Matter of the Requests of )  
)  
HAWAII ELECTRIC LIGHT COMPANY, INC.)  
)  
To Institute a Proceeding Relating) )  
To Competitive Procurement to) )  
Acquire a Battery Energy Storage) )  
System in North Kohala. )  
\_\_\_\_\_ )

DOCKET NO. 2022-0012

ORDER NO. **38195**

OPENING THE DOCKET

By this Order,<sup>1</sup> the Public Utilities Commission ("Commission") opens this docket to receive filings, review approval requests, and resolve disputes, if necessary, related to HAWAII ELECTRIC LIGHT COMPANY, INC.'s ("HELCO's") request to proceed with competitive procurement<sup>2</sup> of a

---

<sup>1</sup>The Parties are HAWAIIAN ELECTRIC LIGHT COMPANY, INC. ("HELCO") and the DIVISION OF CONSUMER ADVOCACY ("Consumer Advocate"), an ex officio party pursuant to Hawaii Revised Statutes ("HRS") § 269-51 and Hawaii Administrative Rules ("HAR") § 16-601-62(a).

<sup>2</sup>The Commission expects that procurement of a BESS through this solicitation will generally adhere to the Framework for Competitive Bidding, but the Commission may exercise its discretion to expedite and/or amend certain parts of the Framework to accommodate time constraints that may apply to the potential commercial transactions under this solicitation. See In re Pub. Utils. Comm'n, Docket No. 2003-0372, Decision and Order No. 23121, filed on December 8, 2006, Exhibit A - Framework for Competitive Bidding ("Framework").

5 megawatt ("MW")/ 22 megawatt hours ("MWh") battery energy storage system ("BESS") that will integrate with a microgrid controller system and be located in and serve North Kohala on the island of Hawaii.

I.

BACKGROUND

HELCO provides electric utility service to the island of Hawaii.

A.

Framework for Competitive Bidding

A description of the Framework, the Commission's primary role and duties thereto (including the selection of an independent observer ("IO") for a competitive bidding proceeding initiated at HELCO's behest), and the Commission's authority for opening the subject repository docket, is summarized in an Order issued on February 24, 2011, in In re Public Utils. Comm'n, Docket No. 2011-0038, and that summary description is incorporated by reference herein. In addition, after review of the draft request for proposal ("RFP") and comments from interested stakeholders, as set forth below, the Commission may exercise its discretion to expedite and/or amend certain parts of the Framework to accommodate time constraints that may apply to the potential

commercial transactions under this solicitation (e.g., to allow for the opportunity to meet deadlines to qualify for federal tax incentives).

B.

HELCO's Letter Request

By letter dated October 29, 2021, HELCO requested that the Commission: (1) open a docket for the purpose of receiving filings, reviewing approval requests, and resolving disputes relating to HELCO's plan to acquire a BESS that will integrate with a microgrid controller system and be located in and serve North Kohala on the island of Hawaii; and (2) allow HELCO to move forward with soliciting and hiring an IO to oversee the RFP process for the Commission; or (3) alternatively, the Commission itself solicit and hire an IO.

A copy of HELCO's October 29, 2021 letter request is attached to this Order.

II.

OPENING THE SUBJECT DOCKET

The Commission states, as follows:

1. The Commission opens this docket to receive filings, review approval requests, and resolve disputes, if necessary, related to HELCO's plan to solicit a BESS that will



integrate with a microgrid controller system and be located in and serve North Kohala on the island of Hawaii.

2. The subject docket is intended to serve as a repository for the requisite filings and a forum for resolving approval requests and disputes, and any amendments for this proceeding adopted by the Commission, if necessary.<sup>3</sup>

3. The Commission does not consider the subject docket to be a contested case proceeding.<sup>4</sup>

4. All matters that may require Commission approval related to the resulting RFP, with the exception of the Commission's review and adjudication of any power purchase agreements that may arise from the resulting RFP, will be resolved in this docket.<sup>5</sup>

5. The Commission will appoint an IO to serve as the monitor of the competitive bidding process and to report on the progress and results thereto to the Commission.<sup>6</sup>

---

<sup>3</sup>In re Public Utils. Comm'n, Docket No. 2011-0038, Order filed on February 24, 2011 ("February 24, 2011 Order"), at 5-6.

<sup>4</sup>See February 24, 2011 Order at 5-6.

<sup>5</sup>See February 24, 2011 Order at 5-6.

<sup>6</sup>The Commission plans to oversee the initial filing of the draft RFP and the subsequent comments by interested stakeholders discussed in this Order, but intends to bring in an IO(s) to oversee all additional steps in this process.

6. The parties are HELCO and the DIVISION OF CONSUMER ADVOCACY ("Consumer Advocate"), an ex officio party pursuant to HRS § 269-51 and HAR § 16-601-62(a).<sup>7</sup>

7. In prior proceedings involving the development of an electric utility's RFP to solicit competitive bids for new or additional sources of energy generation, the Commission has consistently held that such a proceeding, by design, provides interested persons with the opportunity to participate in the process set forth in the Framework without the need to formally intervene in the relevant proceeding.<sup>8</sup>

8. As a repository docket, the Commission specifically excludes from this Order any language that invites interested persons to move to intervene or participate in this docket. Instead, the subject repository docket, by design, provides interested persons with the opportunity to participate in the process set forth in the Framework without the need to formally intervene in the docket.<sup>9</sup>

---

<sup>7</sup>See February 24, 2011 Order at 5-6.

<sup>8</sup>See, e.g., In re Pub. Utils. Comm'n, Docket No. 2017-0352, Order No. 34856, "Opening the Docket," filed on October 6, 2017 ("Order No. 34856"), at 6; In re Pub. Utils. Comm'n, Docket No. 2011-0225, Order No. 31446, "(1) Denying the Motions to Intervene and Other Related Motions; and (2) Dismissing Certain Other Motions," filed on September 10, 2013, at 13-15.

<sup>9</sup>Order No. 34856 at 6.

9. HELCO, through the subject docket, seeks to solicit a BESS that will integrate with a microgrid controller system and be located in and serve North Kohala, through a competitive bidding, RFP process. To ensure open transparency in such a repository docket whereby non-parties will have the opportunity to review and comment on the relevant filings without the need to formally intervene, the Commission anticipates that the issuance of a protective order will not be necessary.

10. As initial steps to initiate this competitive procurement process, the Commission files (attached to this Order), HELCO's draft RFP and associated exhibits.

Any comments by interested stakeholders on the draft RFP, supporting documentation, and/or detailed description of how HELCO proposes to successfully execute the competitive bidding process, shall be filed in this docket and served on HELCO and the Consumer Advocate consistent with Order No. 37043, "Setting Forth Public Utilities Commission Emergency Filing and Service Procedures Related to COVID-19" (non-docketed), filed on March 13, 2020 ("Order No. 37043"), no later than February 25, 2022.<sup>10</sup>

---

<sup>10</sup>The Commission notes that the Framework includes a step directing "[t]he utility [to] hold[] a technical conference to discuss the draft RFP with interested parties (which may include potential bidders)," before soliciting comments on a draft RFP. Framework at 19. Given the Framework's intention that competitive

Any stakeholder comments related to the draft RFP, as well as comments and recommendations by the IO on the draft RFP, shall be filed in this docket.

After review of the draft RFP and stakeholder comments, the Commission intends to direct HELCO to finalize and release the RFP after making any necessary modifications.

The Commission will provide further guidance on this competitive procurement, as necessary.

### III.

#### ORDERS

##### THE COMMISSION ORDERS:

1. This docket is opened to receive filings, review approval requests, and resolve disputes, if necessary, related to HELCO's plan to proceed with a competitive bidding process to acquire a BESS on the island of Hawaii.

2. All matters that may require Commission approval related to the resulting RFP, with the exception of the Commission's review and adjudication of any PPA(s) that may arise from the resulting RFP, will be resolved in this docket.

---

bidding be "structured and implemented in a flexible and efficient manner," the Commission will not require HELCO to hold a technical conference to discuss the draft RFP, but will move directly to the comment phase, as set forth above. Id. at 16.

3. The Commission will appoint an IO to monitor the competitive bidding process and to report on the progress and results thereto to the Commission in a forthcoming order.

4. The parties are HELCO and the Consumer Advocate.

5. The Commission issues this Order to enable HELCO to commence the RFP process.

6. The Commission files (attached to this Order), HELCO's draft RFP and associated exhibits.

7. Any comments by interested stakeholders on the draft RFP, supporting documentation, and/or detailed description of how HELCO proposes to successfully execute the competitive bidding process, shall be filed in this docket and served on HELCO and the Consumer Advocate consistent with Order No. 37043, by February 25, 2022.

DONE at Honolulu, Hawaii JANUARY 25, 2022.

PUBLIC UTILITIES COMMISSION  
OF THE STATE OF HAWAII

By James P. Griffin, Chair      By Jennifer M. Potter, Commissioner

APPROVED AS TO FORM:

By Brandon H. Ito, Commission Counsel      By Leodoloff R. Asuncion, Jr., Commissioner



October 29, 2021

The Honorable Chair and Members  
of the Hawai'i Public Utilities Commission  
Kekuanao'a Building, First Floor  
465 South King Street  
Honolulu, Hawai'i 96813

Dear Commissioners:

Subject: Requesting the Commission to Open a Docket to Institute a Proceeding Relating to a Competitive Bidding Process to Acquire Energy Storage  
Development of North Kohala Energy Storage RFP

---

Hawaiian Electric<sup>1</sup> respectfully request that the Commission open a docket for the Company's proposed request for proposals ("RFP") for a microgrid project for North Kohala. This docket would be to receive filings, review approval requests, and resolve disputes, if necessary, related to the RFP.

Recognizing the need for an Independent Observer for this RFP under the Framework for Competitive Bidding,<sup>2</sup> Hawaiian Electric respectfully requests that the Commission allow the Company to move forward with soliciting and hiring an Independent Observer to oversee the RFP process for the Commission, or alternatively requests the Commission to solicit and hire an Independent Observer.

Hawaiian Electric respectfully submits a proposed draft version of a North Kohala Energy Storage Request for Proposals for Hawai'i Island ("North Kohala Energy Storage RFP") and supporting documentation. The Company notes that this RFP should be filed in the docket that the Commission opens for this matter, as requested above.

Hawaiian Electric submits the following exhibits with this transmittal:

- Exhibit 1: Description of development of the draft North Kohala Energy Storage RFP;
- Exhibit 2: Proposed Timelines for the North Kohala Energy Storage RFP;

---

<sup>1</sup> Hawai'i Electric Light Company, Inc. is referred to as "Hawaiian Electric" or the "Company".

<sup>2</sup> See Decision and Order No. 23121 in Docket No. 03-0372 (To Investigate Competitive Bidding for New Generating Capacity in Hawai'i)

The Honorable Chair and Members  
of the Hawai'i Public Utilities Commission  
October 29, 2021  
Page 2

- Exhibit 3: Hawaiian Electric Companies' Code of Conduct Pertaining to the Implementation of a Competitive Bidding Process for the North Kohala Energy Storage RFP ("Competitive Bidding Code of Conduct");
- Exhibit 4: Proposed draft North Kohala Energy Storage RFP;
- Exhibit 5: Draft Model Energy Storage Services Agreement ("ESSA")

The proposed drafts of the North Kohala Energy Storage RFP and model ESSA will be made available to the public on Hawaiian Electric's website at <https://www.hawaiianelectric.com/NorthKohalaEnergyStorageRFP> ("RFP Website") no later than Tuesday, November 2, 2021.

The Company looks forward to working with the Commission, the Independent Observer, and stakeholders to finalize the RFP and launching a competitive and successful procurement.

Sincerely,

/s/ Rebecca Dayhuff Matsushima

Rebecca Dayhuff Matsushima  
Director  
Renewable Acquisition

Attachments

cc: Division of Consumer Advocacy

# EXHIBIT 1

Description of Development of draft North Kohala  
Energy Storage RFP



**Exhibit 1**  
**Description of Development of the Draft North Kohala Energy Storage Request  
for Proposals**

This Exhibit 1 explains the Hawaiian Electric Companies’<sup>1</sup> process and rationale for developing the proposed competitive bidding process set forth in the Request for Proposals (“RFP”) for the North Kohala Energy Storage solicitation.

**I. Background**

The North Kohala area of Hawai‘i Island is served by a single 69 kV radial transmission line. Built in the 1950s, it spans approximately 24 miles between Waimea and Halaula/Hawi. There are approximately 2,000 customers served by this transmission line. The Company recognized the need to replace or rebuild the aging line to improve reliability and resilience and worked with the community to develop several options.

The first option was to install a second transmission line and substation, which would create a redundant, diverse path for power, and which would increase resilience and increase capacity for renewable generation in the area. Construction of this line could take place without taking outages on the existing transmission line and could allow more flexibility in the timeline and strategy for the rebuild.

The second option presented was to rebuild the existing transmission line and create a microgrid in the North Kohala area to provide power to customers while the line was out of service, supported by temporary diesel generators.

The third option, and the one that ultimately received the most support from stakeholders, was a variation of the second option, in that it also involves a rebuild of the existing transmission line and creating a microgrid in the North Kohala area. However, based on the desires expressed by the community, instead of supporting the microgrid by diesel generators, the third option contemplates the microgrid being supported by a battery energy storage system (“BESS”), allowing it to utilize as-available renewable energy. The microgrid would allow for the flexibility to perform the transmission line rebuild over multiple years. This option was the most well-received and as a result, the Company decided to pursue the microgrid with BESS for North Kohala. Consistent with the Commission’s general guidance to pursue resources through competitive bidding, the Company proposes issuing an RFP for the BESS, while maintaining operational control of the microgrid controller, to which the BESS will be required to interface.

Recognizing the uniqueness of the microgrid solution being sought for North Kohala, and the complexity of third-party ownership of the BESS, the Company engaged Entura, an Australia-based power consulting firm, to provide guidance on technical requirements and procurement and contracting mechanisms. The Companies selected Entura due to their expertise and proven experience with designing small island microgrid systems that incorporated high levels of variable renewable energy and energy storage.

---

<sup>1</sup> Hawaiian Electric Company, Inc., Maui Electric Company, Limited, and Hawai‘i Electric Light Company, Inc. are each referred to as a “Company” and collectively as the “Hawaiian Electric Companies” or “Companies.”

On August 18, 2021, the Company informed stakeholders that it intended to issue a RFP for an energy storage solution to integrate with a Company microgrid controller application for North Kohala on Hawai'i Island. In a virtual meeting on September 2, 2021, the Company provided stakeholders the opportunity to review the history and context for the procurement and to provide feedback for the development of the RFP. Entura provided a technical presentation at this meeting which outlined the reasoning behind the approach and operational requirements.

The Company released a draft of the RFP on September 23, 2021 and hosted a Technical Status Conference on September 30, 2021. Comments to the RFP were requested by October 7, 2021.

In addition, the draft North Kohala Energy Storage RFP was shaped by the Company's following guiding principles, which are used for of all the Company's RFPs developed pursuant to the Competitive Bidding Framework:

- 1. Transparency, predictability and streamlining lowers costs to customers and fosters trust in the process.** Although this RFP is unique in its purpose, the Company has worked hard to continue its efforts to learn from past procurements and to further streamline the process and make it more transparent and predictable for all stakeholders, including holding numerous discussions with the community and other stakeholders to seek their input on solutions to improve reliability and resilience in North Kohala.

The North Kohala community has played an important role in shaping this project. The outreach and engagement efforts were based on a collaborative approach which included many face-to-face meetings with a diverse group of stakeholders. The goal was to share information and gather feedback on the various options. Those conversations helped the Company understand the community's perspective. The options were modified to address their concerns and the changes were shared with the community. Government and community leaders were kept informed through focus groups, round table discussions, and regular briefings. Updates were also provided during town halls hosted by elected officials. Partnerships were formed with organizations that work to keep the community safe, healthy and connected. One of the partnerships was with Hawaii Energy, who the Company worked closely with to educate the community about rebate programs to help conserve energy and reduce load. The results of the extensive outreach were shared at the Resilience and Sustainability Forum which was hosted in partnership with the North Kohala CDP Action Committee in November 2019. Representatives from Hawai'i County Civil Defense, Hawai'i County Council, Hawai'i Institute of Pacific Agriculture, and Hawaiian Electric served as panelists. The forum also featured information booths from our partners at Hawai'i Energy, North Kohala Community Policing, North Kohala Community Emergency Response Team, and Hawai'i Wildlife Center. The Company found that the majority of the community expressed support for the microgrid with a battery storage option. This engagement model is based on collaboration and partnerships. It helps the Company learn about and address the needs of a community. It leads to solutions that are as fair, equitable and practical as possible.

2. **Community engagement is critical to near-term and long-term project success.** As the Company has noted in past procurements, like all businesses in Hawai‘i, developers have a critical role and responsibility to Hawai‘i’s communities, particularly those in which they operate. The Company expects the storage operator to operate in a manner that is consistent with the Company’s values, particularly aloha – taking care of our community, our Hawai‘i and its future, and integrity – being honest and ethical in our words and actions. With this RFP, the Company has committed to leading the community engagement as part of the overall microgrid outreach but is requiring the selected energy storage developer to participate in such engagement.
3. **Coordination and collaboration of all parties involved is necessary to achieve a successful and timely procurement.** As this is a first of its kind procurement, it is more important than ever that coordination and collaboration of all parties occur to ensure the success of the project and the microgrid as a whole. This RFP will require collaboration with and support of regulatory, state, and county agencies, in addition to developers, communities, non-profits and other industry stakeholders.
4. **There is no perfect answer; tradeoffs must be considered.** As the Company seeks to achieve many objectives, such as transparency, predictability, expediency, reliability, community engagement, alignment with grid needs and low cost, optimizing one objective may deteriorate another. The proposed North Kohala Energy Storage RFP is the result of years of engagement with the community and consideration of many options, including the inherent tradeoffs of such options. Depending on a particular party’s priorities and interests, different conclusions could be made for such tradeoffs, and there is no perfect answer. Through the process, the microgrid and BESS solution emerged as the clear preference of the community, and the Company developed this RFP accordingly. This experience is a good example of why the Company believes upfront understanding and input into the process is so important.

To provide more clarity to the RFP documents, the following sections explain some of the key components in the development of the North Kohala Energy Storage RFP.

## II. Requests for Proposals

### Procurement Targets and Scope

The RFP is seeking a standalone BESS with 5 megawatts (MW) / 22 megawatt hours (MWh) of energy storage capacity for integration with the microgrid controller system to serve the North Kohala area on the island of Hawai‘i. The BESS with microgrid controller capabilities is expected to seamlessly transition between grid-connected and island modes for planned transmission outages. While there will be short outage for unplanned outages of the transmission line, the restoration will be seamless. The microgrid BESS is expected to operate as a Grid Forming, black start resource capable of providing power to serve customers in the microgrid when islanded by a planned or unplanned outage of the 3300 line, and in the absence of any conventional synchronous generation. It is expected that the microgrid provide service consistent with utility-provided service (e.g., power quality and safety/protection) when in island mode operation. The Grid Forming function of the BESS microgrid resource inverters is expected to allow distributed PV to operate within the

microgrid when islanding under the same customer use profile as if grid connected. The microgrid is intended to be able to operate without any conventional synchronous generation resources and has been sized to be able to support islanded operation during average weekday loading conditions between the hours of 6 a.m. and 4 p.m., to facilitate 1-hour transitions to and from islanding mode at the beginning and conclusion of an 8-hour workday on the 3300 line.

#### Energy Storage Services Agreement

The Company intends to contract the energy storage resource using its Model Energy Storage Services Agreement (“ESSA”), which treats the energy storage resource as fully dispatchable. In general, the terms and conditions of the ESSA are similar to those incorporated in the Renewable Dispatchable Generation PPAs utilized in the Companies’ Stage 1 and Stage 2 RFPs and the Stage 2 Model Energy Storage Power Purchase Agreement. However, the technical and operational requirements of this procurement differ from those in the paired and standalone storage projects in the Companies’ Stage 1 and Stage 2 RFPs to meet the needs of this particular use case. The microgrid BESS resource sought for procurement in this RFP is expected to operate as the only Grid Forming resource in the microgrid boundary to provide acceptable power quality in the microgrid when islanded in the absence of any conventional synchronous generation. As such, this energy storage resource is the critical and essential element for provision of reliable energy to form an operable microgrid. This unique use case required the Company, with the guidance of its consultant, Entura, to make significant changes to certain provisions common to the Stage 1 and Stage 2 model contracts for this acquisition.

#### Community Outreach

The overall North Kohala microgrid project is unique in that the Company will contract for a third-party BESS while owning and operating the microgrid controller. As the Company will be managing the overall microgrid project, it will take the lead with regard to community engagement and cultural resource matters. Therefore, the Community Engagement evaluation criteria was removed from this RFP. However, the selected Proposer will still be required to fully cooperate with and assist the Company with these community outreach efforts.

#### Independent Observer

Consistent with the Framework for Competitive Bidding, the Company proposes that the RFP will be conducted under the oversight of an Independent Observer. The Company is prepared to hire an Independent Observer that would report to the Commission, similar to CBRE, or having one hired and appointed by the Commission, similar to the Companies Stage 1 and Stage 2 RFPs. The Company seeks further clarity on the Commission’s preference so that an Independent Observer could be brought on as quickly as possible and not cause any delays to the process.

#### Project Site

The Company will be offering a pre-determined Company-controlled project site, referred to as the Akoni Pule Site in Hawi Village, North Kohala, for the location of the BESS. It is approximately 1.207 acres and adjoins the existing Company-owned Hawi Substation, where the microgrid controller will be located. The Company is providing this site with the intent to reduce cost and

shorten development timelines of the project. The Company is currently leasing this site, but is in negotiations to purchase the site. The land rights and obligations of the selected Proposer are covered in Attachment X to the ESSA.

#### Procurement Timeline

The schedule included in Section 3 of the North Kohala Energy Storage RFP anticipates that the RFP will be issued in early February 2022, with proposals due in early April 2022. The RFP's establishment of the project site and scoping specifications will allow for an accelerated evaluation period and selections to be made in mid-July of 2022. This RFP has set a proposed guaranteed commercial operations date of November 22, 2024, to align with the projected in-service date of the microgrid controller. Both the BESS and microgrid controller components will need to be operational for the microgrid solution to be effective. Any changes that the Commission may elect to make in the schedule leading up to the issuance of the RFP may have an effect on the rest of the procurement timeline, including the commercial operations date.

#### Interconnection Cost

The Company has proposed that the Company-Owned Interconnection Facilities should be paid for by the Company as part of the overall microgrid project. As any proposal would have the same interconnection requirements and would be using the same site, such cost information is not unique to the project and therefore should not factor into the evaluation of proposals.

### **III. Next Steps**

As noted in the proposed schedule shared at the September 30, 2021 Technical Conference and included as Exhibit 2 to this filing, the Company anticipates that it will file its proposed final draft RFP later this year, after the Commission has had the opportunity to review and provide comment. However, the Company recognizes the Commission may make modifications to the schedule proposed in Exhibit 2, which could, in turn, affect the schedule included in Section 3.1 of the RFP. The Company will review submitted comments and thoughtfully consider them, prior to preparing a proposed final North Kohala Energy Storage RFP to be filed on December 20, 2021.

The Company looks forward to continuing to work with the Commission, Consumer Advocate, and stakeholders to finalize the North Kohala Energy Storage RFP to begin the process of addressing the reliability issues for the customers in the North Kohala area.

# EXHIBIT 2

## Proposed Timelines for the North Kohala Energy Storage RFP

## Proposed Timelines for the North Kohala Energy Storage RFP

### RFP Schedule

<b>Milestone</b>	<b>Schedule Dates</b>
(1) Distribute RFP for Stakeholder input	September 23, 2021
(2) Technical Status Conference	September 30, 2021
(3) Parties and Participants file comments by	October 7, 2021
(4) Draft RFP filed	October 29, 2021
(5) PUC to provide comments by	November 29, 2021
(6) Proposed Final RFP filed	December 20, 2021
(7) Final RFP is Issued	February 3, 2022 <sup>7</sup>
(8) Hawaiian Electric Proposal Due Date	April 4, 2022 at 2:00 pm HST
(9) IPP and Affiliate Proposal Due Date	April 5, 2022 at 2:00 pm HST
(10) Selection of Final Award Group	July 18, 2022
(11) Contract Negotiations Start	July 25, 2022

## EXHIBIT 3

Hawaiian Electric Companies' Code of Conduct Pertaining  
to the Implementation of a Competitive Bidding Process  
for the North Kohala Energy Storage RFP



## **The Hawai'i Electric Light Company's Code of Conduct**

Hawai'i Electric Light Company, Inc. ("Company") Code of Conduct Pertaining to the Implementation of a Competitive Bidding Process for the North Kohala Energy Storage RFP

### **Purpose**

The Framework for Competitive Bidding ("Framework"), adopted on December 8, 2006, by the Public Utilities Commission of the State of Hawai'i (the "Commission") pursuant to Decision and Order No. 23121 (Docket No. 03-0372, Instituting a Proceeding to Investigate Competitive Bidding for New Generating Capacity in Hawaii), requires that the utility develop and follow a code of conduct in order to ensure the fairness and integrity of the competitive bidding process, in particular where a utility or its affiliate seeks to advance a system resource proposal in response to a Company RFP (as defined below). The Framework, at Section III.A.4, requires the utility to submit to the Commission for review and approval (subject to modification, if necessary, by the Commission), a Code of Conduct prior to the commencement of any competitive bid process under the Framework.

This *Code of Conduct Pertaining to the Implementation of a Competitive Bidding Process for the North Kohala Energy Storage RFP* ("Code of Conduct") outlines the policies and general procedures under which the competitive bidding process for system resources will be undertaken by the Company to ensure that the competitive bidding process is undertaken in a fair and unbiased manner, that all proposers have access to the same information to ensure no proposer has an unfair advantage, and that Hawaiian Electric Proposal Team and/or affiliate options do not have any unfair competitive advantage or enjoy undue preference over third-party bids.

### **Definitions**

- Affiliate – Any person or entity that possesses an "affiliated interest" in a utility as defined by section 269-19.5, Hawaii Revised Statutes ("HRS"), including a utility's parent holding company but excluding a utility's subsidiary or parent which is also a regulated utility.
- Affiliate Team – Employees and consultants of an Affiliate of the Company who prepare a proposal to be submitted to a Company in response to a Company RFP.
- Code of Conduct Acknowledgement – The Competitive Bidding Code of Conduct Acknowledgement of Receipt form required to be executed acknowledging review of, and agreeing to abide by, this Code of Conduct and its RFP Code of Conduct Procedures Manual.
- Code of Conduct Procedures Manual – The Company-prepared manual required by the Framework which implements procedures, in accordance with the policies outlined in the Framework and this Code of Conduct, for communications within the Company between the Company RFP Team, Shared Resources and Unassigned Company Resources and between the Company and proposers into an RFP, including a Hawaiian Electric Proposal Team and/or Affiliate Team.

- Communications Log – A written record to note activities and/or information shared between the Company RFP Team or Hawaiian Electric Proposal Team with Shared Resources or Unassigned Company Resources, accessed via the RFP Communication Tool Kit SharePoint Site.
- Company – Hawai‘i Electric Light Company, Inc.
- Company Executive in Charge – The Company executive responsible for ensuring compliance with this Code of Conduct and serving as the point of contact for the Independent Observer for reporting any violations by the Company of the Code of Conduct. The Company Corporate Compliance Officer shall remain responsible for the Company independent corporate code of conduct and may support compliance matters and questions arising with employees, agents and other representatives of the Company, e.g., conflicts of interest, with respect to this Code of Conduct.
- Company RFP – A written request for proposal issued by the electric utility to solicit bids from interested third-parties, and where applicable from the utility or its affiliate, to supply a future system resource or a block of system resources to the utility pursuant to the competitive bidding process.
- Company RFP Team – The Company personnel and outside consultants responsible for the development of the Company’s RFP conducted under the Framework and the evaluation of bids submitted in response to this RFP. Subject to the transfer rules specified in the Company Code of Conduct Procedures Manual, the Company RFP Team will have fixed team members who will not have any involvement with the Hawaiian Electric Proposal Team for the RFP.
- Confidential Information – Any non-public information developed and provided by the Company (e.g., proprietary system information) or proposers during the RFP process (such non-public information may include, for example, the identity of competing proposers, and their technical, trade or financial information). This term includes any material non-public information regarding the RFP process developed for and used during the competitive bidding solicitation process, such as the evaluation process or criteria. Confidential Information includes Confidential Resource Proposal Information and Confidential RFP Process Information but does not include public information, such as information in the Company’s public filings with the Commission.
- Confidential Resource Proposal Information – Any non-public information developed and provided by the Hawaiian Electric Proposal Team, its affiliates or third-party proposers during the RFP process (such non-public information may include, for example, the identity of competing proposers, and their technical, trade or financial information).
- Confidential RFP Process Information – Any non-public information regarding the RFP process developed and used during the competitive bidding solicitation process.
- Consumer Advocate – The Division of Consumer Advocacy of the Department of Commerce and Consumer Affairs, State of Hawai‘i.
- Director of Renewable Acquisition – The supervisor of the Division that will oversee the Company’s competitive bidding process.
- Energy Contract Manager – The staff position(s) within the Company’s Renewable Acquisition Division responsible for managing the Company RFP Team. The Energy Contract Manager shall be a member of the Company RFP Team.
- Hawaiian Electric Proposal Team – The Company personnel and outside consultants responsible for the development of the Hawaiian Electric Proposal Team’s response to the RFP. Subject to the transfer rules specified in the Company Code of Conduct Procedures Manual, the Hawaiian Electric Proposal Team will have fixed team members who will not

have any involvement with the Company RFP Team for the RFP.

- Independent Observer – The neutral person or entity either appointed by the Commission or, at the direction of the Commission, identified and retained by the utility to monitor the utility's competitive bidding process, and to advise the utility and Commission on matters arising out of the competitive bidding process, as described in Part III.C of the Framework.
- Manager of Energy Procurement – The supervisor of the department within the Company's Renewable Acquisition Division responsible for directing the resources responsible for the implementation of the competitive bidding process pursuant to the Framework. The Manager of Energy Procurement will report to the Director of Renewable Acquisition on the status of the competitive bidding process and shall be a member of the Company RFP Team.
- Non-Wires Alternative - An electricity grid project that uses non-traditional transmission and distribution (T&D) solutions, such as distributed generation (DG), energy storage, energy efficiency (EE), demand response (DR) and grid software and controls, to defer or avoid the need for conventional transmission and/or distribution infrastructure investments.
- Roster – A consolidated list of members that comprise the Company RFP Team, Hawaiian Electric Proposal Team, Shared Resources and Unassigned Company Resources located in the RFP Communication Tool Kit SharePoint Site. Names and roles of Company employees and consultants will be identified.
- Shared Resources – Company employees and consultants who, because of the scarcity of their expertise within the Company, are designated and authorized to provide information or input to both the Company RFP Team and the Hawaiian Electric Proposal Team (but not any Affiliate Team) and is not a resource dedicated to either team. For example, Shared Resources may include an environmental attorney and members of the Company's Risk Management Department.
- Unassigned Company Resources – Company employees unassigned to an essential team that may be called upon by the Company RFP Team and/or the Hawaiian Electric Proposal Team (but not any Affiliate Team) to assist in meeting unforeseen tasks for the RFPs or the Hawaiian Electric Proposal Team proposals. For example, the RFP team may be unable to evaluate an unforeseen technical specification included in a bid. In that event, the RFP team would need to request assistance from a Company employee or a consultant that is not already assigned to an essential team and possesses the specific expertise. Such personnel are intended to assist the requesting team only in an ad hoc manner, limited in scope and purpose to the particular task required.

## **Implementation and Application of the Code of Conduct**

Employees of the Company who will be involved in the competitive bidding process must comply with the Code of Conduct. Members of the Company RFP Team, Hawaiian Electric Proposal Team, Shared Resources and Unassigned Company Resources must implement the Code of Conduct in order to be eligible to evaluate bids or participate in the development and submission of a Company system resource option.<sup>1</sup> The Code of Conduct addresses: (1) communication requirements and procedures associated with the relationship between utility employees; (2)

---

<sup>1</sup> Note: Shared Resources and Unassigned Company Resources are not eligible to evaluate bids. See *Rules for Evaluators* herein.

communication requirements and procedures associated with the relationship between utility RFP personnel and proposers; and (3) communication requirements associated with the relationship between Company management and the various entities involved in the competitive bidding process. The Code of Conduct Procedures Manual implements the requirements of the Framework and this Code of Conduct and provides further requirements for such communications.

The Code of Conduct also includes the procedures for addressing cases where limited resources and expertise of the Company may be shared by the Hawaiian Electric Proposal Team and Company RFP Team. While the Company will make every reasonable effort to develop internally separate teams for evaluating the bids and developing the Hawaiian Electric Proposal Team options, the small size of the Company and limitation of resources and expertise generally will require specialized services, information exchange and sharing of resources in certain limited circumstances, such as in the course of resource planning activities. Where the Company has identified these limited resources and expertise, the Company has designated such resources and expertise as Shared Resources with strict communications restrictions and the requirement to maintain the Communication Log of all communications with either team.

Finally, this Code of Conduct does not apply to communications and information shared between utility employees in the normal course of their employment that is not associated with any active RFP.

### **General Rules**

1. Competitive Bidding Code of Conduct Acknowledgement of Receipt. Any employee (whether full-time, part-time, temporary or contract) or consultant involved in the competitive bidding process as a member of the Company RFP Team or the Hawaiian Electric Proposal Team, or designated as a Shared Resource or Unassigned Company Resource, shall comply with the rules of conduct in this Code of Conduct and the procedures outlined in the Code of Conduct Procedures Manual and must sign the Code of Conduct Acknowledgement.
2. Separation of Teams; No Transfer Between Teams. To enhance the opportunity to maintain separation of resources between the Company RFP Team and the Hawaiian Electric Proposal Team, while recognizing the potential problems associated with limited resources, the following procedures shall be followed. The Company RFP Team will have no involvement with the Hawaiian Electric Proposal Team with respect to the RFP. Further, no team member from one team may switch teams, i.e., from the Company RFP Team to the Hawaiian Electric Proposal Team and vice versa, within any particular stage or phase of the RFP. Other employees, not a member of any team, could serve as Shared Resources or Unassigned Company Resources, but will be subject to the conditions defined in General Rules 7 and 8, respectively, below.
3. No Involvement with Affiliate Teams. Affiliate Teams shall be considered and treated as a separate third-party proposer for all purposes within the RFP. There shall be no communication or interaction between the Company RFP Team and any Affiliate Team except as may be permitted under the Framework, this Code of Conduct or the Code of Conduct Procedures Manual and consistent in all respects with communications and

interactions permitted with unaffiliated third-party proposers. Affiliate Teams shall have no access to, interaction or communications with Shared Resources or Unassigned Company Resources for the purpose of completing a proposal in response to the RFP. Affiliates of the Company shall also be subject to the terms, conditions and restrictions specified in the Company's Affiliate Transaction Requirements issued by the Commission.<sup>2</sup>

4. Duty Not to Disclose Confidential Information Across Teams. Members of the Company RFP Team may work with members of the Hawaiian Electric Proposal Team or with an Affiliate on other projects not related to the Company RFP, but are prohibited from discussing or disclosing, directly or indirectly through a conduit, Confidential Information with: (i) the Hawaiian Electric Proposal Team and any Affiliates except in accordance with the procedures outlined in this Code of Conduct and the RFP, or (ii) any other Company employee, individual or entity without a business need to know. No transfer of an employee of the Company, including to an Affiliate, shall be used to circumvent this prohibition to create a conduit for the prohibited transfer of Confidential Information.
5. Work Locations. Members of the Company RFP Team and the Hawaiian Electric Proposal Team do not have to be physically separated from each other but members of each team must take all reasonable measures to keep all Confidential Information (including electronic data) pertaining to the competitive bidding process confidential.
6. Roster. The Roster for the Company RFP Team, the Hawaiian Electric Proposal Team, Shared Resources and identified Unassigned Company Resources will be maintained by the Company and provided to the Independent Observer upon request. All team members will be specifically identified by name and role.
7. Managing of Shared Resources. Certain Company resources, such as select staff from various functional areas of the Company (e.g., generation and transmission planning, engineering, system and power plant operations, environmental, financial analysis, risk management, etc.) that are not members of any team, may be treated as a shared resource to perform services for the Company RFP Team and to carry on their regular functions throughout the resource planning process (including the development of the utility's Parallel Plan or Contingency Plan as defined in the Framework), which may require communication with or services performed for the Hawaiian Electric Proposal Team. Shared Resources may perform these services subject to complying with the Code of Conduct and the Code of Conduct Procedures Manual. Any information received by employees serving as a Shared Resource from their communication with one team (either the Company RFP Team or Hawaiian Electric Proposal Team) will not, either directly or indirectly through others, be provided to members on the other team or to other proposers, except through the formal RFP communication process. A written record of the time, date and substance of all conversations, data and written material directly or indirectly exchanged with any member of the Company RFP Team or the Hawaiian Electric Proposal Team that pertain to the Company RFP, shall be maintained on the Communication Log. The Independent Observer will have contemporaneous access to the Communication Log. In any limited case where information or resources are required to be provided by one team

---

<sup>2</sup>See Order No. 36112, issued January 24, 2019, in Docket No. 2018-0065, establishing those certain Affiliate Transaction Requirements for the Company and its Affiliates.

to another, and because of confidentiality or proprietary reasons, cannot be disseminated through the means specified in the Company RFP, all such communications will be directed through the Energy Contract Manager copied to and with direct oversight by the Independent Observer.

8. Managing of Unassigned Company Resources. Certain Unassigned Company Resources may be requested to perform services for either the Company RFP Team or the Hawaiian Electric Proposal Team on an *ad hoc* basis that does not necessitate such resource being added to the team requesting assistance. Such Unassigned Company Resources may provide such services subject to complying with the Code of Conduct and the Code of Conduct Procedures Manual. In connection with providing such services, a written record of such services shall be maintained in the same manner and fashion as the written records required of Shared Resources on the Communication Log. The Independent Observer will have contemporaneous access to this Communication Log.
9. Access to Information During Bidding Period. It is the objective of the Company that all proposers, as well as the Hawaiian Electric Proposal Team and any Affiliate Team, receive access to the same RFP information at the same time. All communications regarding the RFP will be provided to all proposers through the communication means specified in the Company RFP or other specialized means of access established for purposes of administering the RFP. No members of the Hawaiian Electric Proposal Team or Affiliate Team will have access to such information before it is distributed to all potential proposers.
10. Duty Not to Disclose Confidential Resource Proposal Information During RFP Process. All Confidential Resource Proposal Information shall be held in confidence during the RFP evaluation and selection process and negotiation of contracts with selected proposers (if necessary), and shall not be discussed or exchanged by the Company RFP Team with any party except the proposer providing the information, Company management personnel responsible for resource decisions, Company RFP Team members, the Independent Observer, and the Commission and the Consumer Advocate, and their respective staffs and consultants. Dissemination of such Confidential Resource Proposal Information shall be limited, to the extent possible, to those with a business need to know.
11. Prohibition of Hawaiian Electric Proposal Team and Affiliates from Advance Disclosure of Confidential Resource Proposal Information to Company RFP Team. The Hawaiian Electric Proposal Team and any Affiliate Team are prohibited from providing team members of the Company RFP Team with any Confidential Resource Proposal Information pertaining to the development of a Hawaiian Electric Proposal Team or Affiliate Team resource option in response to a Company RFP until after that proposal is officially submitted.
12. Treatment of Information Requests from Hawaiian Electric Proposal Team and Affiliate Team. The Company RFP Team will treat all requests from the Hawaiian Electric Proposal Team and Affiliate Team for information pertaining to the Company RFP in the same manner as requests received from non-affiliate entities. The Hawaiian Electric Proposal Team and the Affiliate Team will be required to submit all questions in writing and will receive a response via the communication means specified in the Company RFP, as would any other proposers.

13. No Preferential Treatment. The Company RFP Team, when evaluating proposals will give all proposals the same consideration within the parameters of the particular RFP and the eligibility, threshold and evaluation requirements and criteria contained therein. Hawaiian Electric Proposal Team bids and Affiliate Team bids will not be given any preferential or discriminatory treatment.
14. Applicability of Code. Any employee or consultant who directly or indirectly takes part in the conduct of the competitive bidding process, whether an employee of the Company or of a company under contract, shall comply with the requirements for treatment of Confidential Information obtained during the competitive bidding process. Such employee or consultant shall execute the Acknowledgement required under General Rule 1 above.
15. Rules for Evaluators. Any employee or consultant taking part in the evaluation of bids or in the process of selecting system resources (the "evaluator") must comply with the following rules and eligibility requirements:
  - a. In carrying out his or her responsibilities, the evaluator must make his/her decision based on the merits of the proposal and irrespective of all partisan considerations;
  - b. The evaluator must not accept any gifts, favors, entertainment or other advantages from any proposers;
  - c. The evaluator must hold in confidence all Confidential Information obtained through the bidding process;
  - d. Should the evaluator be directly contacted by any proposer, including members of the Hawaiian Electric Proposal Team or Affiliate Team, he/she must promptly relate such contact to the Energy Contract Manager, and, as applicable, the Independent Observer, if such contact could be deemed to have compromised the evaluation process.
  - e. Evaluators shall be members of the Company RFP Team, separated into price and non-price evaluation teams. See *Code of Conduct Procedures Manual* for details.
  - f. Shared Resources and Unassigned Company Resources shall not be permitted to participate, or advise the Company RFP Team, in evaluating bids.
16. Company Officer Certification of Code of Conduct Compliance. A Company officer, identified to the Independent Observer and the Commission, shall have the written authority and obligation to enforce the Code of Conduct. Such officer shall certify, by affidavit, Code of Conduct compliance by all employees participating in a specific RFP process after each specific RFP process ends.
17. Term. This Code of Conduct shall remain in effect until: (a) the final contract(s) for RFPs conducted under the Framework with the successful proposer(s) is/are executed or when written notice of termination of the RFPs to be conducted under the Framework is provided by the Manager of Energy Procurement or his/her designee to the Independent Observer and the Commission; and (b) a certification of Code of Conduct compliance by all employees participating in the specific RFP process is submitted by affidavit by the Company Executive in Charge. The Code of Conduct shall remain in effect through all

stages or phases of a particular RFP, regardless of the length of time between such stages or phases in the RFP.



# EXHIBIT 4

Proposed draft North Kohala Energy Storage RFP

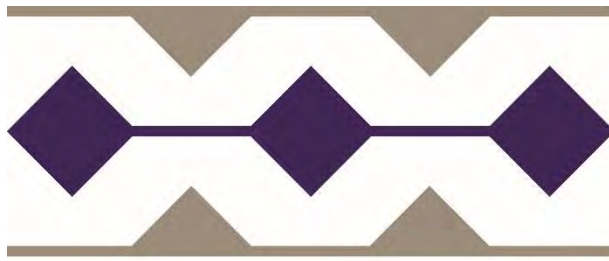

**Hawai'i  
Electric  
Light**

**DRAFT**

**REQUEST FOR PROPOSALS**

**FOR**

**NORTH KOHALA**

**ENERGY STORAGE**

**ISLAND OF HAWAI'I**

OCTOBER 29, 2021

Docket No. TBD

This Request for Proposals (“RFP”) is a DRAFT only. Hawai‘i Electric Light Company, Ltd. (“Hawai‘i Electric Light” or “Company”) will employ a competitive bidding process to select an energy storage project consistent with the State of Hawai‘i Public Utilities Commission’s (“PUC”) Competitive Bidding Framework. Under the Competitive Bidding Framework, Hawai‘i Electric Light files the initial draft RFP with the PUC. Then, Hawai‘i Electric Light will seek input from prospective Proposers and other stakeholders through a Technical Conference as described in the draft RFP and modify the draft RFP to the extent feasible to address input received in order to foster a robust competitive process. The proposed final RFP will be submitted to the PUC for approval and is subject to further revision based upon direction received from the PUC. After approval by the PUC, Hawai‘i Electric Light will issue the final RFP.

## Table of Contents

Chapter 1: Introduction and General Information .....	1
1.1 Authority and Purpose of the Request for Proposals .....	2
1.2 Scope of the RFP .....	2
1.3 Competitive Bidding Framework .....	4
1.4 Role of the Independent Observer .....	4
1.5 Communications Between the Company and Proposers – Code of Conduct Procedures Manual.....	4
1.6 Company Contact for Proposals .....	5
1.7 Proposal Submittal Requirements.....	5
1.8 Proposal Fee.....	6
1.9 Procedures for any Hawaiian Electric or Affiliate Proposals .....	7
1.10 Dispute Resolution Process.....	9
1.11 No Protest or Appeal.....	10
1.12 Modification or Cancellation of the Solicitation Process .....	10
1.13 Community Outreach.....	11
Chapter 2: Resource Needs and Requirements .....	11
2.1 Performance Standards .....	11
2.2 Distribution-Level System Information.....	12
2.3 Interconnection to the Company System .....	12
Chapter 3: Instructions to Proposers .....	13
3.1 Schedule for the Proposal Process .....	13
3.2 Company RFP Website / Electronic Procurement Platform.....	14
3.3 Information Exchange.....	15
3.4 Preparation of Proposals .....	15
3.5 Organization of the Proposal .....	16
3.6 Proposal Limitations .....	16
3.7 Proposal Compliance and Bases for Disqualification.....	17
3.8 Power Purchase Agreement .....	17
3.9 Pricing Requirements.....	19
3.10 Project Description.....	19
3.11 Project Site .....	20

3.12	Confidentiality .....	20
3.13	Credit Requirements Under the ESSA.....	21
Chapter 4: Evaluation Process and Evaluation Criteria .....		22
4.1	Proposal Evaluation and Selection Process .....	22
4.2	Eligibility Requirements Assessment .....	24
4.3	Threshold Requirements Assessment .....	25
4.4	Evaluation – Price and Non-Price Analysis.....	26
4.5	Selection of Awardee .....	30
Chapter 5: Post Evaluation Process .....		31
5.1	Interconnection Requirements Study Process.....	31
5.2	Contract Negotiation Process.....	32
5.3	Awardee Commitments .....	33
5.4	Greenhouse Gas Emission Analysis .....	33
5.5	PUC Approval of ESSA.....	34
5.6	Project In-Service.....	34

**List of Appendices**

Appendix A	Definitions
Appendix B	Proposer's Response Package / Project Interconnection Data Request
Appendix C	Code of Conduct Procedures Manual
Appendix D	PowerAdvocate User Information
Appendix E	Mutual Confidentiality and Non-Disclosure Agreement
Appendix F	Description of the Site
Appendix G	Hawaiian Electric Proposal Team Certification Form
Appendix H	Interconnection Facilities and Cost Information
Appendix I	RESERVED
Appendix J	RESERVED
Appendix K	North Kohala Community Comments
Appendix L	North Kohala ESSA
Appendix M	RESERVED
Appendix N	RESERVED
Appendix O	Functional Requirements

## **Chapter 1: Introduction and General Information**

Hawai'i Electric Light Company, Inc. ("Hawai'i Electric Light" or the "Company") seeks proposals for a standalone Battery Energy Storage System ("BESS") for the North Kohala area on the island of Hawai'i in accordance with this Request for Proposals ("RFP"). Hawai'i Electric Light seeks to procure 5 megawatts ("MW") / 22 megawatt hours ("MWh") of standalone energy storage capacity for integration with a microgrid controller system.

The Company or its Affiliates may submit a Proposal in response to this RFP subject to the requirements of this RFP.

The Company intends to contract for a single BESS Project through this RFP using its Energy Storage Services Agreement ("ESSA"), which gives the Company full dispatch rights over the energy storage facilities.

The successful Proposer will provide energy storage services to the Company pursuant to the terms of the ESSA, which will be subject to review and approval by the State of Hawai'i Public Utilities Commission ("PUC").

Proposers are instructed to thoroughly review the Model ESSA attached as Appendix L. The ESSA gives the Company exclusive rights to schedule and control the Project for the use of the defined Performance Standards, which include but are not limited to: Back-up Power, Rated Energy Capacity, Frequency Regulation, Rated Active Power Capacity, Voltage Regulation, Black-Start, ability to operate in grid-forming mode, and any other uses the Project is capable of providing that would benefit the Company's distribution or transmission system; and, in exchange, the Proposer is provided a fixed monthly payment ("Lump Sum Payment"), which is subject to adjustment based on the availability and performance of the Project. Under the ESSA, the Project must meet certain requirements to receive the full lump sum payment each month. These requirements ensure that the Project is available to the Company for scheduled and un-scheduled operation of the microgrid or system needs.

The Company will evaluate Proposals using the evaluation and selection process described in Chapter 4. The Company will evaluate and select a Proposal based on both price and non-price factors that impact the Company, its customers, and communities affected by the proposed Project.

Additionally, the bid price of the Proposal will be added to the estimated cost of the Company's microgrid project. This aggregated cost will then be compared with the estimated value of a traditional second wires path solution. This estimated value is intended to be used as an order of magnitude financial estimate of the non-wires alternative opportunity. The estimated value is based on the current planning level estimate for the traditional second wires path solution.

All requirements necessary to submit a Proposal(s) are stated in this RFP. A description of the technical requirements for Proposers is included in the body of this RFP, Appendix B, and in the ESSA attached as Appendix L.

All capitalized terms used in this RFP shall have the meaning set forth in the glossary of defined terms attached as Appendix A. Capitalized terms that are not included in Appendix A shall have the meaning ascribed in this RFP.

## 1.1 Authority and Purpose of the Request for Proposals

- 1.1.1 This RFP is issued in alignment with the Integrated Grid Planning (“IGP”) process with respect to Non-Wires Opportunity Evaluation Methodology dated June 2020<sup>1</sup>.
- 1.1.2 While storage resources were not contemplated in Decision and Order (“D&O”) No. 23121 in Docket No. 03-0372 (To Investigate Competitive Bidding for New Generating Capacity in Hawai‘i), which sets forth the PUC’s Framework for Competitive Bidding (“Framework” or “Competitive Bidding Framework”), the Company intends to follow the Framework to the extent applicable for this RFP. This RFP is also consistent with the Updated Framework for Competitive Bidding (“Updated Framework” or “Updated Competitive Bidding Framework”), which was drafted to be more inclusive of various technologies, and filed on February 12, 2021 in Docket No. 2018-0165. The Updated Framework is currently pending PUC approval, and if approved prior to the issuance of this RFP, this RFP shall be subject to the Updated Framework.
- 1.1.3 Proposers should review the functional requirements identified in Appendix O which informs Proposers of the system needs.

## 1.2 Scope of the RFP

- 1.2.1 The Company is seeking a standalone storage project that meets the requirements noted in this RFP for integration with a microgrid controller system. This would be the first utility microgrid based on storage in the State of Hawai‘i. Establishing this microgrid system with a BESS provides a non-wires alternative<sup>2</sup> (“NWA”) by providing a grid-forming energy source in the North Kohala area when the 3300 line connection is not available. This energy source will be charged from grid energy while the 3300 line is in service. By supporting the electrical needs of customers during sustained 3300 line outages, this microgrid avoids having to build an alternative transmission path to avoid outages during the rebuilding of the 3300 line, and also, will be able to provide service during unplanned outages. This would improve reliability and resilience for customers in North Kohala while allowing for routine maintenance of the 3300 line without building a second path to serve the area. Installing a microgrid system with a BESS avoids the use of a diesel-powered microgrid, which was also considered, but did not receive the level of community acceptance as a battery solution.
- 1.2.2 Each Proposal submitted in response to this RFP must represent a Project that is capable of meeting the requirements of this RFP without having to rely on a proposed change in law, rule, or regulation.

---

<sup>1</sup> See

[https://www.hawaiianelectric.com/documents/clean\\_energy\\_hawaii/integrated\\_grid\\_planning/stakeholder\\_engagement/working\\_groups/distribution\\_planning/20200602\\_dpwg\\_non\\_wires\\_opportunity\\_evaluation\\_methodology.pdf](https://www.hawaiianelectric.com/documents/clean_energy_hawaii/integrated_grid_planning/stakeholder_engagement/working_groups/distribution_planning/20200602_dpwg_non_wires_opportunity_evaluation_methodology.pdf)

<sup>2</sup> A non-wires alternative, also referred to as non-transmission alternative in this RFP, is generally defined as an electricity grid project that uses non-traditional transmission and distribution solutions, such as distributed generation, energy storage, energy efficiency (“EE”), demand response (“DR”), and grid software and controls, to defer or avoid the need for conventional transmission and/or distribution infrastructure investments. See Docket No. 2018-0165, Hawaiian Electric Companies’ Integrated Grid Planning Workplan, filed December 14, 2018, at 21.

- 1.2.3 Projects must interconnect to the Company’s System at the 34.5 kV level at the existing Hawi Substation located on the island of Hawai‘i (see Section 3.11 of this RFP, Appendix F and Appendix H, Attachment 1).
- 1.2.4 To prevent adverse impacts to the microgrid reliability, the storage system and protection design shall provide sufficient redundancy to avoid single points of failure of critical telemetry measurements.
- 1.2.5 The contract for the Project selected through this RFP shall use the ESSA, as described in Section 3.8. Under the ESSA, the Company will maintain exclusive rights to fully direct charge and discharge of the Project, subject to availability of the resource and Section 1.2.7 below. The term of the ESSA will be 10 years.
- 1.2.6 The Project must be capable of the following Performance Standards: Back-up Power, Rated Energy Capacity, Frequency Regulation, Rated Active Power Capacity, Voltage Regulation, Black-start, ability to operate in grid-forming mode; and, any other uses the Project is capable of providing that would benefit of Company’s distribution or transmission system. The storage will be charged in accordance with the Company design when not in a microgrid configuration, and once charged, remain ready to support microgrid operation for planned and unplanned outages.
- 1.2.7 The Maximum Annual Energy Throughput is expected not to exceed 3960 MWh. The Annual Energy Throughput is the cumulative energy discharged by the Project measured between 12:00am January 1 to 11:59:59pm December 31 in each calendar year. Energy discharge can occur in continuous full discharges or over intermittent discharges and charges.
- 1.2.8 Proposals must specify a Guaranteed Commercial Operations Date (“GCOD”) no later than November 22, 2024.
- 1.2.9 A Proposer’s GCOD set forth in its Proposal will be the GCOD in any resulting ESSA if such Proposal is selected to the Final Award Group. Note that the Company intends to contract for a single BESS Project and therefore the Final Award Group will only consist of one project.
- 1.2.10 The selected Proposer will be responsible for all Project costs throughout the term of the ESSA, including but not limited to Project development, completion of a facility equipment and controls design review, interconnection design review, the cost of conducting a greenhouse gas analysis, land leasing, to the extent set forth in Appendix F to the RFP and the ESSA, permitting, financing, construction of the Project and all Seller-owned Interconnection Facilities, and the operations and maintenance (“O&M”) of the Project.
- 1.2.11 The selected Proposer will be solely responsible for the decommissioning of the Project and the restoration of the Site upon the expiration of the ESSA, as described in Attachment G, Section 7 of the ESSA.



- 1.2.12 To the extent that any federal or state tax credits exist, the selected Proposer shall pursue all such tax credits. Proposal pricing must be set to incorporate the benefit of any such federal or state tax credits.

### **1.3 Competitive Bidding Framework**

Consistent with the Framework, this RFP outlines the Company's requirements in relation to the resources being solicited and the procedures for conducting the RFP process. It also includes information and instructions to prospective Proposers participating in and responding to this RFP.

### **1.4 Role of the Independent Observer**

- 1.4.1 Part III.C.1 of the Framework sets forth the circumstances under which an Independent Observer is required in a competitive bidding process. The Independent Observer will advise and monitor all phases of the RFP process and will coordinate with PUC staff throughout the RFP process to ensure that the RFP is undertaken in a fair and unbiased manner. In particular, the Company will review and discuss with the Independent Observer decisions regarding the evaluation, disqualification, non-selection, and selection of Proposals.

- 1.4.2 The role of the Independent Observer, as described in the Framework, will include but is not limited to:

- Monitor all steps in the competitive bidding process
- Monitor communications (and communications protocols) with Proposers
- Monitor adherence to the Company's Code of Conduct
- Submit comments and recommendations, if any, to the PUC concerning the RFP
- Review the Company's Proposal evaluation methodology, models, criteria, and assumptions
- Review the Company's evaluation of Proposals
- Advise the Company on its decision-making
- Participate in dispute resolution as set forth in Section 1.10
- Monitor contract negotiations with Proposers
- Report to the PUC on monitoring results during each stage of the competitive bidding process
- Provide an overall assessment of whether the goals of the RFP were achieved

- 1.4.3 The Independent Observer for this RFP is: [TBD].  
The Independent Observer Email Address is: [TBD].

### **1.5 Communications Between the Company and Proposers – Code of Conduct Procedures Manual**

- 1.5.1 Communications and other procedures under this RFP are governed by the "Code of Conduct Procedures Manual," (also referred to as the "Procedures Manual") developed by the Company as required by the Framework, and attached as Appendix C.

- 1.5.2 All Proposal communication with prospective Proposers will be conducted via the Company's RFP website, Electronic Procurement Platform, and/or electronic mail ("Email") through the address specified in Section 1.6 (the "RFP Email Address"). Phone communication or face-to-face meetings will not be supported.

To ensure the Independent Observer can monitor communication, questions regarding the RFP or a proposed Project submitted to the RFP Email Address should include the Independent Observer Email Address found in Section 1.4.3. Frequently asked questions submitted by prospective Proposers and the answers to those questions may be posted on the Company's RFP website. The Company reserves the right to respond only to comments and questions it deems are appropriate and relevant to the RFP. Proposers shall submit questions no later than fifteen Days before the Proposal Due Date (see RFP Schedule in Section 3.1, Table 1, Items 8 and 9). The Company will endeavor to respond to all questions no later than five Days before the Proposal Due Date.

- 1.5.3 After Proposals have been submitted, the Company may contact individual Proposers for purposes of clarifying their Proposal(s).
- 1.5.4 Any confidential information deemed by the Company, in its sole discretion, to be appropriate to share, will only be transmitted to the requesting party after receipt of a fully executed North Kohala Mutual Confidentiality and Non-Disclosure Agreement<sup>3</sup> ("NDA"). See Appendix E.
- 1.5.5 Except as expressly permitted and in the manner prescribed in the Procedures Manual, any unsolicited contact by a Proposer or prospective Proposer with personnel of the Company pertaining to this RFP is prohibited.

## **1.6 Company Contact for Proposals**

The primary contact for this RFP is:

Christin Chang  
Energy Contract Manager  
Hawaiian Electric Company, Inc.

RFP Email Address: [renewableacquisition@hawaiianelectric.com](mailto:renewableacquisition@hawaiianelectric.com)

## **1.7 Proposal Submission Requirements**

- 1.7.1 All Proposals must be prepared and submitted in accordance with the procedures and format specified in the RFP. Proposers are required to respond to all questions and provide all information requested in the RFP, as applicable, and only via the communication methods specified in the RFP.
- 1.7.2 Detailed requirements regarding the form, submission, organization and information for the Proposal are set forth in Chapter 3 and Appendix B.

---

<sup>3</sup> See Section 3.12.1 of this RFP.

- 1.7.3 Proposals must not rely on any information that is not contained within the Proposal itself in demonstrating compliance for any requirement in this RFP.
- 1.7.4 In submitting a Proposal in response to this RFP, each Proposer certifies that the Proposal has been submitted in good faith and without fraud or collusion with any other unaffiliated person or entity. The Proposer shall acknowledge this in the Response Package submitted with its Proposal. Furthermore, in executing the NDA provided as Appendix E, the Proposer agrees on behalf of its Representatives (as defined in the NDA) that the Company's negotiating positions will not be shared with other Proposers or their respective Representatives.

In addition, in submitting a Proposal, a Proposer will be required to provide Company with its legal counsel's written certification in the form attached as Appendix B Attachment 1 certifying in relevant part that irrespective of any Proposer's direction, waiver, or request to the contrary, that the attorney will not share a Proposer's confidential information associated with such Proposer with others, including, but not limited to, such information such as a Proposer's or Company's negotiating positions.

- 1.7.5 All proposals must be submitted via the Electronic Procurement Platform by 2:00 pm Hawai'i Standard Time ("HST") on the Proposal Due Date shown in the RFP Schedule in Section 3.1, Table 1, Items 7 and 8. No hard copies of these Proposals will be accepted by the Company.

It is the Proposer's sole responsibility to ensure that complete and accurate information has been submitted on time and consistent with the instructions of this RFP. With this assurance, Company shall be entitled to rely upon the completeness and accuracy of every Proposal. Any errors identified by the Proposer or Company after the Proposal Due Date has passed may jeopardize further consideration and success of the Proposal. If an error or errors are later identified, Company, in consultation with the Independent Observer, may permit the error(s) to be corrected without further revision to the Proposal, or may require Proposer to adhere to terms of the Proposal as submitted without correction. Additionally, and in Company's sole discretion, if such error(s) would materially affect the Final Award Group, Company reserves the right, in consultation with the Independent Observer, to remove or disqualify a Proposal upon discovery of the material error(s). The Proposer of such Proposal shall bear the full responsibility for such error(s) and shall have no recourse against Company's decision to address Proposal error(s), including removal or disqualification. The Energy Contract Manager, in consultation with the Independent Observer, will confirm that all Proposals were submitted by the Proposal Due Dates shown in Section 3.1, Table 1, Item 8 and 9. The Electronic Procurement Platform automatically closes to further submissions after the IPP and Affiliate Proposal Due Date in Section 3.1, Table 1, Item 9.

## **1.8 Proposal Fee**

- 1.8.1 IPP and Affiliate proposers are required to tender a non-refundable Proposal Fee of \$5,000 for each Proposal submitted.

- 1.8.2 The Proposal Fee must be in the form of a cashier's check or equivalent from a U.S.-chartered bank made payable to "Hawai'i Electric Light Company, Inc." and must be delivered and received by the Company by 2:00 pm HST on the Proposal Due Date shown in the RFP Schedule in Section 3.1, Table 1, Item 9. The cashier's check should include a reference to the Proposal(s) for which the Proposal Fee is being provided. Proposers are strongly encouraged to utilize a delivery service method that provides proof of delivery to validate delivery date and time.

If the Proposal Fee is delivered by U.S. Postal Service (with registered, certified, receipt verification), the Proposer shall address it to:

Christin Chang  
Energy Contract Manager  
Hawaiian Electric Company, Inc.  
Mail Code CP21-IU  
PO Box 2750  
Honolulu, Hawai'i 96840

If the Proposal Fee is delivered by other courier services, the Proposer shall address it to:

Hawaiian Electric Company, Inc  
Ward Receiving  
Attention: Christin Chang, Energy Contract Manager  
Mail Code CP21-IU  
799 S. King St.  
Honolulu, Hawai'i 96813

Due to COVID-19 disease prevention measures, Proposal Fees cannot be delivered in person.

## **1.9 Procedures for any Hawaiian Electric or Affiliate Proposals**

- 1.9.1 The Competitive Bidding Framework allows the Company the option to offer a Self-Build Proposal(s) in response to this RFP ("Hawaiian Electric Proposal"). Accordingly, the Company must follow certain requirements and procedures designed to safeguard against and address concerns associated with: (1) preferential treatment of the Hawaiian Electric Proposal or members, agents, or consultants of the Company formulating the Hawaiian Electric Proposal; and (2) preferential access to proprietary information by the Hawaiian Electric Proposal Team. These requirements are specified in the Code of Conduct ("North Kohala Code of Conduct") required under the Framework and implemented by certain rules and procedures found in the Procedures Manual submitted to the PUC in Docket No. TBD on (date – TBD). The North Kohala Code of Conduct will apply regardless of whether the Company will submit a Hawaiian Electric Proposal. A copy of the Procedures Manual is attached as Appendix C.

The Competitive Bidding Framework also allows Affiliates of the Company to submit Proposals<sup>4</sup> to RFPs issued by the Company. All Hawaiian Electric and Affiliate Proposals are subject to the Company's Code of Conduct and the Procedures Manual. Affiliate Proposals are also subject to any applicable Affiliate Transaction Requirements issued by the PUC in Decision and Order No. 35962 on December 19, 2018, and subsequently modified by Order No. 36112, issued on January 24, 2019, in Docket No. 2018-0065. Affiliate Proposals will be treated identically to an IPP Proposal and must be submitted electronically through the Electronic Procurement Platform by the IPP and Affiliate Proposal Due Date in RFP Section 3.1, Table 1, Item 9.

- 1.9.2 The Company will require that the Hawaiian Electric and Affiliate Proposal(s) be submitted electronically through the Electronic Procurement Platform. Hawaiian Electric Proposals will be due a minimum of one (1) Day before other Proposals are due. Hawaiian Electric Proposals will be uploaded into the Electronic Procurement Platform in the same manner Proposals from other Proposers are uploaded. The Energy Contract Manager, in consultation with the Independent Observer, will confirm that the Hawaiian Electric Proposals are timestamped by the Hawaiian Electric Proposal Due Date shown in RFP Section 3.1, Table 1, Item 8.
- 1.9.3 Detailed requirements for a Hawaiian Electric Proposal can be found in Appendix G. These requirements are intended to provide a level playing field between Hawaiian Electric Proposals and third-party Proposals. Except where specifically noted, a Hawaiian Electric Proposal must adhere to the same price and non-price Proposal requirements as required of all Proposers, as well as certain ESSA requirements, such as milestones and liquidated damages, as described in Appendix G. The non-negotiability of the Performance Standards shall apply to any Hawaiian Electric Proposal to the same extent it would for any other Proposal. Notwithstanding the fact that it will not be required to enter into an ESSA with the Company, a Hawaiian Electric Proposer will be required to note its exceptions, if any, to the ESSA in the same manner required of other Proposers, and will be held to such modified parameters if selected. In addition to its Proposal, the Hawaiian Electric Proposal Team will be required to submit Appendix G Attachment 1, Hawaiian Electric Proposal Team Certification Form, acknowledging it has followed the rules and requirements of the RFP to the best of its ability and has not engaged in any collusive actions or received any preferential treatment or information providing an impermissible competitive advantage to the Hawaiian Electric Proposal Team over other Proposers responding to this RFP, as well as adherence to ESSA terms and milestones required of all Proposers and the Hawaiian Electric Proposal's proposed cost protection measures.

The cost recovery methods between a regulated utility proposal and IPP proposals are fundamentally different due to the business environments they operate in. As a result, the Company has instituted a process to compare the two types of proposals for the evaluation of the price related criteria on a 'like' basis through comparative analysis.

---

<sup>4</sup> A Proposal will also be treated as an Affiliate Proposal if the Affiliate is a partner for the Proposal.

At the core of a Hawaiian Electric Proposal are its total project capital cost and any associated annual operations and maintenance (“O&M”) costs. During the RFP’s pricing evaluation step, these capital costs<sup>5</sup> and O&M costs will be used in a revenue requirement calculation to determine the estimated revenues needed from customers which would allow the Company to recover the total cost of the Project. The Hawaiian Electric Proposal revenue requirements are then used in a levelized benefit calculation to determine a Levelized Benefit (“LB”) (\$/MWh) which will then be used for comparison to IPP and any Affiliate Proposals.

The Company, in conjunction with the Independent Observer, may also conduct a risk assessment of the Hawaiian Electric Proposal to ensure an appropriate level of customer cost protection measures are included in such Proposal.

The Hawaiian Electric Proposal will be permitted to submit a shared savings mechanism with its Proposal to share in any cost savings between the amount of cost bid in the Hawaiian Electric Proposal and the actual cost to construct the Project. If the Hawaiian Electric Proposal is selected to the Final Award Group, the proposed shared savings mechanism will need to be approved by the PUC. Submission of a shared savings mechanism is not required and will not be considered in the evaluation of the Hawaiian Electric Proposal.

## **1.10 Dispute Resolution Process**

- 1.10.1 If disputes arise under the RFP, the provisions of Section 1.10 and the dispute resolution process established in the Framework will control. See Part V of the Framework.
- 1.10.2 Proposers who challenge or contest any aspect of the RFP process must first attempt to resolve their concerns with the Company and the Independent Observer (“Initial Meeting”). The Independent Observer will seek to work cooperatively with the parties to resolve any disputes or pending issues and may offer to mediate the Initial Meeting to resolve disputes prior to such issues being presented to the PUC.
- 1.10.3 Any and all disputes arising out of or relating to the RFP which remain unresolved for a period of twenty (20) Days after the Initial Meeting takes place may, upon the agreement of the Proposer and the Company, be submitted to confidential mediation in Honolulu, Hawai‘i, pursuant to and in accordance with the Mediation Rules, Procedures, and Protocols of Dispute Prevention Resolution, Inc. (“DPR”) (or its successor) or, in its absence, the American Arbitration Association then in effect (“Mediation”). The Mediation will be administered by DPR. If the parties agree to submit the dispute to Mediation, the Proposer and the Company shall each pay fifty percent (50%) of the cost of the Mediation (i.e., the fees and expenses charged by the mediator and DPR) and shall otherwise each bear their own Mediation costs and attorneys’ fees.

---

<sup>5</sup> Hawaiian Electric Proposals will be required to provide a table identifying project costs by year. These capital costs should be all inclusive, including but not limited to costs associated with equipment, Engineering, Procurement, and Construction (“EPC”), interconnection, overhead, and Allowance for Funds Used During Construction (“AFUDC”).

- 1.10.4 If settlement of the dispute is not reached within sixty (60) Days after commencement of the Mediation, or if after the Initial Meeting, the parties do not agree to submit any unresolved disputes to Mediation, then as provided in the Framework, the Proposer may submit the dispute to the PUC in accordance with the Framework.
- 1.10.5 In accordance with the Framework, the PUC will serve as the arbiter of last resort for any disputes relating to this RFP involving Proposers. The PUC will use an informal expedited dispute resolution process to resolve the dispute within thirty (30) Days, as described in Parts III.B.8 and V of the Framework.<sup>6</sup> There will be no right to hearing or appeal from this informal expedited dispute resolution process.
- 1.10.6 If any Proposer initiates a dispute resolution process for any dispute or claim arising under or relating to this RFP, other than that permitted by the Framework and this Section 1.10 (e.g., a court proceeding), then such Proposer shall be responsible for any and all attorneys' fees and costs that may be incurred by the Company or the PUC in order to resolve such claim.

### **1.11 No Protest or Appeal**

Subject to Section 1.10, no Proposer or other person will have the right to protest or appeal any award or disqualification of a Project made by the Company.

By submitting a Proposal in response to the RFP, the Proposer expressly agrees to the terms and conditions set forth in this RFP.

### **1.12 Modification or Cancellation of the Solicitation Process**

- 1.12.1 Unless otherwise expressly prohibited, the Company may, at any time up to the final execution of an ESSA, as may be applicable, in consultation with the Independent Observer, postpone, withdraw, and/or cancel any requirement, term, or condition of this RFP, including deferral of the award or negotiation of any contract, and/or cancellation of the award all together, all of which will be without any liability to the Company.
- 1.12.2 The Company may modify this RFP subject to requirements of the Framework, whereby the modified RFP will be reviewed by the Independent Observer and submitted to the PUC thirty (30) Days prior to its issuance, unless the PUC directs otherwise. See Framework Part IV.B.10. The Company will follow the same procedure with regard to any potential postponement, withdrawal, or cancellation of the RFP or any portion thereof.

---

<sup>6</sup> The informal expedited dispute resolution process does not apply to PUC review of contracts that result from the RFP. See Decision and Order No. 23121 at 34-35. Further, the informal expedited dispute resolution process does not apply to the Framework's process relating to issuance of a draft and final RFP, and/or to the PUC approval of the RFP because: (1) the Framework (and the RFP) set forth specific processes whereby interested parties may provide input through the submission of comments; and (2) the Framework's dispute resolution process applies to "Bidders" and there are no "Bidders" at this stage in the RFP process.

### **1.13 Community Outreach**

The North Kohala community has played an important role in shaping this project. The Company took a collaborative approach in developing plans to improve resilience and reliability in the North Kohala area. The Company shared information and requested feedback through focus groups, conducted roundtables with key community members, and provided regular briefings to Hawai‘i Island government leaders, and provided updates at town halls hosted by elected officials. The Company also formed partnerships with organizations that work to keep the North Kohala community safe, healthy and connected. Through these partnerships, the Company hosted or participated in several events including the North Kohala Resilience and Sustainability Forum and various community fairs and festivals. As a result of the feedback and input provided by community members, the Company was able to develop the proposed microgrid project and the requirements of this RFP.

## **Chapter 2: Resource Needs and Requirements**

### **2.1 Performance Metrics and Standards**

Proposals must meet the attributes set forth in this RFP and the requirements of the ESSA. This RFP, and the ESSA set forth the minimum requirements that all Proposals must satisfy to be eligible for consideration in this RFP. Additional Performance Standards may be required based on the results of the IRS.

The ESSA should be referenced for the complete list of Performance Metrics and Standards and details of each; but the following Performance Standards are considered of utmost importance to ensure acceptable performance of the proposed resource and are reproduced here for reference:

“Back-up Power” means the capability to supply power to maintain service continuity and grid resilience in the event of an outage, at the direction of the Company.

“Rated Energy Capacity” means the amount of energy that the Project is capable of discharging in megawatt-hours (MWh), measured between the maximum and minimum allowable states of charge and available to the Company.

“Frequency Regulation” means the capability to consume or deliver active power, for the purpose of retaining a target frequency under changing load and generation conditions.

“Rated Active Power Capacity” means the total possible instantaneous discharge capability in megawatts (MW) of the Project, or the maximum rate of discharge that the Project can achieve, starting from a fully charged state, and available to the Company.

“Voltage Regulation” means the ability to compensate for anomalies or disturbances (e.g., voltage magnitude, harmonics, etc.) to achieve a target voltage at the Point of Interconnection by manipulating the reactive energy component of the Project.



“Black-Start” means the capability of the Project to self-start, and also energize the islanded transformers and loads, as defined in the RFP, in a single breaker closure without outside assistance. Further, inverter-based resources shall ensure they have sufficient energy storage to maintain power injection to the grid during system restoration (i.e., have power available when and if called upon). The capability of the Project to energize transformers and loads is only required within the limits of the Rated Active Power Capacity and Rated Energy Capacity. The Company is responsible for determining the required minimum capacities of the Project.

The Project must also meet all other Performance Standards described in Section 3 of Attachment B of the ESSA; including but not limited to reactive capability, ride-through, and the ability to operate in grid-forming (“GFM”) mode as further described in the ESSA.

The functionality and characteristics of the storage must be maintained throughout the term of the ESSA. To be clear, Proposers are to determine how to manage degradation, either from oversizing battery capacity or managing cell replacement to retain performance over the entire term.

## **2.2 Transmission-Level System Information**

The Company has performed a preliminary evaluation of the Transmission System which indicates a BESS of the requested size is able to interconnect and support the North Kohala area. The Company will provide line data and load transformer datasheets to Proposers to simulate a black start of the microgrid system in an electromagnetic transient (“EMT”) environment system if requested via the communication methods identified in Section 1.5 and upon the execution of an NDA as specified in Section 3.12.1. Proposals are required to provide EMT simulation results demonstrating acceptable black start performance of the microgrid using the proposed resource. Further, as part of this RFP, fault current levels at select busses are provided and Proposals are expected to verify their proposed resource can achieve these fault current levels in modeling. A detailed IRS will be required to ensure the Project BESS size, proposed inverter equipment, and controller settings are providing acceptable performance when grid connected, islanding, and during Black Start. Additional system mitigation measures in the form of additional equipment is not expected to be required to integrate any specific Project selected through this RFP and if any is identified the addition will be at the cost of the Company. Per Section 3.11 and Appendix F, Projects must interconnect to the Company’s System at 34.5 kV level at the existing Hawi Substation located on the island of Hawai‘i. The estimated configuration of the interconnection is provided in Appendix H. Any questions regarding the interconnection may be directed to the RFP Email Address in Section 1.6.

## **2.3 Interconnection to the Company System**

- 2.3.1 The Proposer must provide all information pertaining to the design, development, and construction of the Seller-Owned Interconnection Facilities as specified in Appendix B.

- 2.3.2 All Proposals must provide a completed Project Interconnection Requirement Study Data Request worksheet, which can be found in Appendix B, Attachment 2, with their Proposal submission. All project diagram(s), models for equipment and controls (see Appendix B, Attachments 3 and 4), list(s) identifying components and respective files (for inverters and power plant controller), and complete documentation with instructions must also be submitted with their Proposal submission. The proposed Interconnection Facilities must be compatible with the Company System and in coordination with Company Owned Interconnection Facilities. In the design, Projects must adequately consider Company requirements to address impacts on the performance and reliability of the Company System. Please see Appendix B for reference.
- 2.3.2.1 In addition to the Performance Standards and findings of the IRS, the design of the Interconnection Facilities, including power rating, Point of Interconnection with the Company System, and scheme of interconnection, must meet Company standards as applicable.
- 2.3.2.2 Interconnection Facilities must be designed such that it meets or exceeds the applicable single line diagram in Appendix H, Attachment 1.
- 2.3.3 RESERVED
- 2.3.4 The Proposer shall be responsible for building all Seller-Owned Interconnection Facilities and for all costs for Seller-Owned Interconnection Facilities needed to interconnect a Project to the Company System. The Company will be responsible for building all Company-Owned Interconnection Facilities and for all costs for Company-owned Interconnection Facilities needed to interconnect a Project to the Company system.
- 2.3.5 Proposers are required to include in their pricing proposal all costs for interconnection and distribution equipment expected to be required between their Project and the Point of Interconnection. The selected Proposer shall be responsible for the actual final costs of all Seller-Owned Interconnection Facilities (see Appendix H), whether or not such costs exceed the costs set forth in a Proposer's Proposal. No adjustments will be allowed to the proposed price in a Proposal if actual costs for Interconnection Facilities exceed the amounts proposed.
- 2.3.6 RESERVED
- 2.3.7 All Projects will be screened for general readiness to comply with the requirements for interconnection. The selected Proposal will be subject to further study in the form of an IRS. The IRS process is further described in Section 5.1. The results of the completed IRS, as well as any mitigation measures identified, will be incorporated into the terms and conditions of a final executed ESSA.

### **Chapter 3: Instructions to Proposers**

#### **3.1 Schedule for the Proposal Process**

Table 1 sets forth the proposed schedule for the proposal process (the “RFP Schedule”). The RFP Schedule is subject to PUC approval. The Company reserves the right to revise the RFP Schedule as necessary. Changes to the RFP Schedule prior to the RFP Proposal Due Date will be posted to the RFP website. Changes to the RFP Schedule after the Proposal Due Date will be communicated via email to the Proposers and posted on the RFP Website.

**Table 1  
RFP Schedule**

<b>Milestone</b>	<b>Schedule Dates</b>
(1) Distribute RFP for Stakeholder input	September 23, 2021
(2) Technical Status Conference	September 30, 2021
(3) Parties and Participants file comments by	October 7, 2021
(4) Draft RFP filed	October 29, 2021
(5) PUC to provide comments by	November 29, 2021
(6) Proposed Final RFP filed	December 20, 2021
(7) Final RFP is Issued	February 3, 2022 <sup>7</sup>
(8) Hawaiian Electric Proposal Due Date	April 4, 2022 at 2:00 pm HST
(9) IPP and Affiliate Proposal Due Date	April 5, 2022 at 2:00 pm HST
(10) Selection of Final Award Group	July 18, 2022
(11) Contract Negotiations Start	July 25, 2022

### 3.2 Company RFP Website/Electronic Procurement Platform

3.2.1 The Company has established a website for general information to share with potential Proposers. The RFP website is located at the following link:

[www.hawaiianelectric.com/NorthKohalaEnergyStorageRFP](http://www.hawaiianelectric.com/NorthKohalaEnergyStorageRFP)

The Company will provide general notices, updates, schedules and other information on the RFP website throughout the process. Proposers should check the website frequently to stay abreast of any new developments. This website will also contain the link to the Electronic Procurement Platform employed by the Company for the receipt of Proposals.

“Sourcing Intelligence” developed by Power Advocate is the Electronic Procurement Platform that the Company has licensed and will utilize for the receipt of Proposals in this RFP. Proposers who do not already have an existing account with PowerAdvocate and who intend to submit a Proposal for this RFP will need to register as a “Supplier” with PowerAdvocate.

<sup>7</sup> Per Section IV.B.6.e.ii of the Competitive Bidding Framework “[t]he utility shall have the right to issue the RFP if the Commission does not direct the utility to do otherwise within thirty (30) days after the Commission receives the proposed RFP and the Independent Observer's comments and recommendations.” February 3, 2022 assumes the Company issues a Final RFP to comply with Commission guidance received after 30 days. The Final RFP may be issued sooner, but the Company will not issue the Final RFP without Commission guidance.

- 3.2.2 There are no license fees, costs, or usage fees to Proposers for the use of the Electronic Procurement Platform.

See Appendix D for user information on and screenshots of PowerAdvocate's Sourcing Intelligence procurement platform.

### **3.3 Information Exchange**

The Company held a stakeholder outreach meeting on September 2, 2021 to discuss the needs set forth in this RFP and gain stakeholder input. A recording of the September 2, 2021 stakeholder outreach meeting can be found on the Company's RFP website.

The Company also conducted a Technical Status Conference on September 30, 2021 to discuss this draft RFP. Parties and Participants had the opportunity to submit comments on the draft RFP. A recording of the Technical Status Conference can be found on the RFP website. The Company has reviewed and answered questions sent in by stakeholders which can be found on the RFP website and is now submitting this draft RFP for PUC review and approval.

Additionally, the Company will hold a prerecorded webinar in accordance with the Competitive Bidding Framework for prospective Proposers to learn about the provisions and requirements of this RFP. This prerecorded webinar will be posted to the Company's RFP website within one week of the issuance of the final RFP. Prospective Proposers may also submit written questions regarding the RFP to the RFP Email Address set forth in Section 1.6. The Company will endeavor to address all questions that will be helpful to prospective Proposers via a Q&A section on the RFP website.

Prospective Proposers should review the RFP Website's Q&A section prior to submission of their Proposal. Duplicate questions will not be answered.

### **3.4 Preparation of Proposals**

- 3.4.1 Each Proposer shall be solely responsible for reviewing the RFP (including all attachments and links) and for thoroughly investigating and informing itself with respect to all matters pertinent to this RFP, the Proposer's Proposal, and the Proposer's anticipated performance under the ESSA. It is the Proposer's responsibility to ensure it understands all requirements of the RFP, to seek clarification if the RFP's requirements or Company's request is not clear, and to ask for any confirmation of receipt of submission of information. Under Section 1.7.5, the Proposer is solely responsible for all errors in its Proposal(s). The Company will not accept any assertion by a Proposer that it was incumbent on the Company to catch any error.
- 3.4.2 Proposers shall rely only on official information provided by the Company in this RFP when preparing their Proposal. The Company will rely only on the information included in the Proposals and additional information solicited by the Company to Proposers in the format requested, to evaluate the Proposals received. Evaluation will be based on the stated information in this RFP and on information submitted by Proposers in response to

this RFP. Proposals must clearly state all capabilities, functionality and characteristics of the Project; must clearly detail plans to be performed; must explain applicability of information; and must provide all referenced material if it is to be considered during the Proposal evaluation. Referencing previous RFP submissions or projects for support will not be considered. Proposers should not assume that any previous RFP decisions or preferences also apply to this RFP.

- 3.4.3 Each Proposer shall be solely responsible for, and shall bear all of its costs incurred in the preparation of its Proposal and/or its participation in this RFP, including, but not limited to, all costs incurred with respect to the following: (1) review of the RFP documents; (2) status conference participation; (3) third-party consultant consultation; and (4) investigation and research relating to its Proposal and this RFP. The Company will not reimburse any Proposer for any such costs, including the selected Proposer.
- 3.4.4 Each Proposal must contain the full name and business address of the Proposer and must be signed by an authorized officer or agent<sup>8</sup> of the Proposer.

### **3.5 Organization of the Proposal**

- 3.5.1 The Proposal must be organized as specified in Appendix B. It is the Proposer's responsibility to ensure the information requested in this RFP is submitted and contained within the defined Proposal sections as specified in Appendix B.

### **3.6 Proposal Limitations**

Proposers expressly acknowledge that Proposals are submitted subject to the following limitations:

The RFP does not commit or require the Company to award a contract, pay any costs incurred by a Proposer in the preparation of a Proposal, or procure or contract for products or services of any kind whatsoever. The Company reserves the right, in consultation with the Independent Observer, to accept or reject, in whole or in part, any or all Proposals submitted in response to this RFP, to negotiate with any or all Proposers eligible to be selected for award, or to withdraw or modify this RFP in whole or in part at any time.

- The Company reserves the right, in consultation with the Independent Observer, to request additional information from any or all Proposers relating to their Proposals or to request that Proposers clarify the contents of their Proposals. Proposers who are not responsive to such information requests may be eliminated from further consideration upon consultation with the Independent Observer.

---

<sup>8</sup> Proposer's officer or agent must be authorized to sign the Proposal. Such authorization must be in writing and may be granted via Proposer's organizational documents (i.e., Articles of Incorporation, Articles of Organization, By-laws, etc.), resolution, or similar documentation.

- The Company reserves the right, in consultation with the Independent Observer, to solicit additional Proposals from Proposers after reviewing the initial Proposals. Other than as provided in this RFP, no Proposer will be allowed to alter its Proposal or add new information to a Proposal after the Proposal Due Date.
- All material submitted in response to this RFP will become the sole property of the Company, subject to the terms of the NDA.

Proposers understand and agree that if its Proposal is selected by the Company for the Final Award Group, such selection shall in no way constitute the Company's confirmation that a Proposer's Project will meet the requirements under this RFP, e.g., that the Project's proposed interconnection is feasible and will meet the Company's requirements. The Proposer is ultimately responsible for ensuring that its Project meets the technical requirements specified in this RFP, and if the parties reach agreement on the ESSA, the requirements specified in the ESSA.

### **3.7 Proposal Compliance and Bases for Disqualification**

Proposers may be deemed non-responsive and/or Proposals may not be considered for reasons including, but not limited to, the following:

- Any unsolicited contact by a Proposer or prospective Proposer with personnel of the Company pertaining to this RFP as described in Section 1.5.5.
- Any illegal or undue attempts by or on behalf of the Proposer or others to influence the Proposal Review process.
- The Proposal does not meet one or more of the Eligibility Requirements specified in Section 4.2.
- The Proposal does not meet one or more of the Threshold Requirements specified in Section 4.3.
- The Proposal is deemed to be unacceptable through a fatal flaws analysis as described in Section 4.4.2.
- The Proposer does not respond to a Company request for additional information to clarify the contents of its Proposal within the timelines specified by the Company.
- The Proposal contains misrepresentations or errors.

### **3.8 Energy Storage Services Agreement**

- 3.8.1 The Agreement for proposals selected under this RFP will be in the form of the ESSA, attached as Appendix L.

- 3.8.2 If selected, any Affiliate Proposer will be required to enter into the ESSA with the Company.
- 3.8.3 If selected, a Hawaiian Electric Proposer will not be required to enter into an ESSA with the Company. However, the Hawaiian Electric Proposer will be held to the proposed modifications to the ESSA, if any, it submits as part of the Hawaiian Electric Proposal in accordance with Section 3.8.6. Moreover, the Hawaiian Electric Proposal will be held to the same performance metrics and milestones set forth in the ESSA to the same extent as all Proposers, as attested to in the Hawaiian Electric Proposal's Appendix G, Attachment 1, Hawaiian Electric Proposal Team Certification submittal. If liquidated damages are assessed, they will be paid from shareholder funds and returned to customers through the Purchased Power Adjustment Clause ("PPAC") or other appropriate rate adjustment mechanisms.
- To retain the benefits of operational flexibility of a Company-owned facility, the Hawaiian Electric Proposal will be permitted to adjust operational requirements and performance metrics with the approval of the PUC. The process for adjustment would be similar to a negotiated amendment to an ESSA with PUC approval.
- 3.8.4 In general, under the ESSA, payment to the Seller consists of a Lump Sum Payment component to cover the costs of the Project. In return, the ESSA gives the Company exclusive rights to schedule and control the energy storage facility. The monthly Lump Sum Payment is subject to adjustment based on the availability and performance of the Project.
- 3.8.5 The Performance Standards identified in Section 2.1 of this RFP and Attachment B, Section 3 of the ESSA establish the minimum requirements a Proposal must satisfy to be eligible for consideration in this RFP. A proposed Project's ability to meet these Performance Standards is both a Threshold Requirement and a Non-Price Related Criteria under Sections 4.3 and 4.4.2, respectively. As such, these Performance Standards included in the ESSA are non-negotiable. Proposers may propose modifications to other sections of the ESSA but are encouraged to accept such terms as written in order to expedite the overall RFP process and potential contract negotiations. As a component of their Proposals, Proposers who elect to propose modifications shall provide a Microsoft Word red-line version of the relevant document identifying specific proposed modifications to the model language that the Proposer is agreeable to, as well as a detailed explanation and supporting rationale for each modification.
- 3.8.5.1 General comments, drafting notes and footnotes such as "parties to discuss", and reservation of rights to propose modifications at a later time are unacceptable and will be considered non-responsive. Proposed modifications to the ESSA will be evaluated as a non-price evaluation criterion as further described in Section 4.4.2. In order to facilitate this process, the Company will make available an electronic version of the model agreement on the RFP website and through the Electronic Procurement Platform for the RFP. Any proposed modifications to the ESSA will be subject to negotiation between the Company and the Final Award Group and should not be assumed to have been accepted either as a result of being selected to the Final Award Group or based on any

previously executed PPA. As stated above, since general comments, drafting notes, and footnotes without accompanying specific proposed language modifications are unacceptable and non-responsive, the Company will not negotiate provisions simply marked by such general comments, drafting notes, and footnotes.

- 3.8.6 Proposals that do not include specific proposed modifications to the attached ESSA will be deemed to have accepted the ESSA in its entirety.

### 3.9 Pricing Requirements

- 3.9.1 Proposers are responsible for understanding the terms of the ESSA. Pricing cannot be specified as contingent upon other factors.
- 3.9.2 Escalation in pricing over the term of the ESSA is prohibited.
- 3.9.3 Pricing information must only be identified within specified sections of the Proposal instructed by this RFP's Appendix B Proposer's Response Package (i.e., Proposal pricing information must be contained within defined Proposal sections of the Proposal submission). Pricing information contained anywhere else in a Proposal will not be considered during the evaluation process.
- 3.9.4 The Proposer's Response Package must include the following prices for each Proposal:

For IPP or Affiliate proposals:

- **Lump Sum Payment (\$/year):** Payment amount for exclusive rights to schedule and control the Project. Payment will be made in monthly increments.

For the Hawaiian Electric Proposal:

- **Total Project Capital Costs (\$/year):** Total capital costs for the Project (identified by year).
- **Annual O&M Costs (\$/year):** Initial year operations and maintenance costs, annual escalation rate.
- **Annual Revenue Requirement (\$/year):** Annual revenue requirements (ARR) calculated for each year.

Additional description and detail on the Total Project Capital Costs, Annual O&M Costs, and Annual Revenue Requirement for the Hawaiian Electric Proposal is located in Appendix G.

### 3.10 Project Description

- 3.10.1 RESERVED



- 3.10.2 Each Proposer must also agree to provide Project financial information, including proposed Project finance structure information specified in Appendix B. Such information will be used to evaluate Threshold Requirements and non-price criteria (e.g., Financial Viability of Proposer, Financial Strength and Financing Plan, State of Project Development and Schedule) set forth in Sections 4.3 and 4.4.2. Upon selection, the Final Award Group may be requested to provide further detailed cost information if requested by the PUC or the Consumer Advocate as part of the ESSA approval process. If requested, such information would be provided to the PUC, Consumer Advocate, and Company pursuant to a protective order in the docket.
- 3.10.3 The Proposer agrees that no material changes or additions to the Project from what is submitted in its Proposal will be made without the Proposer first having obtained prior written consent from the Company. Evaluation of all Proposals in this RFP is based on the information submitted in each Proposal at the Proposal Due Date. If any Proposer requests that any Proposal information be changed after that date, the Company, in consultation with the Independent Observer, and in consideration of whether the evaluation is affected, will determine whether the change is permitted.

### **3.11 Project Site**

All Proposals must be sited on a pre-determined Company Controlled Project Site, referred to as the Akoni Pule Site. The available area is approximately 1.207 acres located along Akoni Pule Highway in Hawi Village, North Kohala, and is further described in Appendix F. Additional details regarding the specific interconnection requirements for a Project sited at the Akoni Pule Site are described in Appendix H.

The selected Proposer will be required to agree to specific terms and conditions for such use as provided for in Attachment X of the ESSA. Provisions providing for access to the site during construction and thereafter, during commercial operations, will be subject to current Company security policies and procedures, including any additional restrictions due to COVID-19. Physical, communication, and internet security will be required consistent with Company policy. Additional measures may be required to limit or eliminate interference between Seller and Company facilities and infrastructure. Such policies, procedures, and requirements may change as necessary during the term of the ESSA to reflect changes in Company policies or to remain in compliance with current applicable laws, rules, or regulations. Additional information regarding the site can also be found in Appendix F.

Due to COVID-19 travel restrictions, a site visit will not be available at this time. The Company will endeavor to provide as much information as possible to interested potential Proposers, and if conditions related to the ongoing health pandemic do not allow for an in-person visit early in the bid submittal period, the Company will provide additional information which may include photographs and/or video. Information on a potential in-person site visit or any additional information will be posted on the Company's RFP website.

### **3.12 Confidentiality**

- 3.12.1 Each prospective Proposer must submit an executed NDA in the form attached as Appendix E by the Proposal Due Date specified in the RFP Schedule in Section 3.1, Table 1. The form of the NDA is not negotiable. Information designated as confidential by the Company will be provided on a limited basis, and only those prospective Proposers who have submitted an executed NDA will be considered. Proposers must clearly identify all confidential information in their Proposals. However, Proposers should designate as confidential only those portions of their Proposals that genuinely warrant confidential treatment. The Company discourages the practice of marking every page of a Proposal as confidential. The Company will make reasonable efforts to protect any such information that is clearly marked as confidential. Consistent with the terms of the NDA, the Company reserves the right to share any information, even if marked confidential, with its agents, contractors, or the Independent Observer for the purpose of evaluating the Proposal and facilitating potential contract negotiations.
- 3.12.2 Proposers, in submitting any Proposal to Company in response to this RFP, certify that such Proposer has not shared its Proposal, or any part thereof, with any other Proposer of a Proposal responsive to this RFP.
- 3.12.3 The Company will request that the PUC issue a Protective Order to protect confidential information provided by Proposers to the Company and to be filed in a proceeding before the PUC. A copy of the Protective Order, once issued by the PUC, will be provided to Proposers. Proposers should be aware that the Company may be required to share certain confidential information contained in Proposals with the PUC, the State of Hawai'i Department of Commerce and Consumer Affairs, Division of Consumer Advocacy, and the parties to any docket instituted by the PUC, provided that recipients of confidential information have first agreed in writing to abide by the terms of the Protective Order. Notwithstanding the foregoing, no Proposer will be provided with Proposals from any other Proposer, nor will Proposers be provided with any other information contained in such Proposals or provided by or with respect to any other Proposer.

### **3.13 Credit Requirements Under the ESSA**

- 3.13.1 The Proposer with whom the Company enters into an ESSA must post Development Period Security and Operating Period Security in the form of an irrevocable standby letter of credit from a bank chartered in the United States as required and set forth in Article 14 of the ESSA. Cash, a parent guaranty, or other form of security will not be accepted in lieu of the irrevocable standby letter of credit.
- 3.13.2 The Development Period Security and Operating Period Security identified in the ESSA are minimum requirements. Proposers shall not propose an amount lower than that set forth in the ESSA.
- 3.13.3 Each Proposer shall be required to provide a satisfactory irrevocable standby letter of credit in favor of the Company from a bank chartered in the United States to guarantee Proposer's payment of interconnection costs for all relocation costs in excess of Total

Estimated Relocation Costs that are payable to Company as required and set forth in Attachment G to the ESSA.

- 3.13.4 Proposers may be required to provide an irrevocable standby letter of credit in favor of the Company from a bank chartered in the United States in lieu of the required Source Code Escrow in an amount and as required and set forth in Attachment B to the ESSA.

## **Chapter 4: Evaluation Process and Evaluation Criteria**

### **4.1 Proposal Evaluation and Selection Process**

The Company will employ a multi-step evaluation process. Once the Proposals are received, the Proposals will be subject to a consistent and defined review, evaluation, and selection process. This Chapter provides a description of each step of the process, along with the requirements of Proposers at each step. Figure 1 sets forth the flowchart for the proposal evaluation and selection process.

Upon receipt of the Proposals, the Company will review each Proposal submission to determine if it meets the Eligibility Requirements and the Threshold Requirements. The Company, in coordination with the Independent Observer will determine if a Proposer is allowed to cure any aspect of its Proposal or whether the Proposal will be eliminated based on failure to meet either Eligibility or Threshold Requirements.<sup>9</sup> If a Proposer is provided the opportunity to cure any aspect of its Proposal, the Proposer shall be given three (3) business days to cure from the date of notification to cure<sup>10</sup>. Proposals that have successfully met the Eligibility and Threshold Requirements will then enter a price and non-price evaluation process, ultimately ending in a Proposal being selected to the Final Award Group.

---

<sup>9</sup> As a general rule, if a Proposer does not include a requested document, inadvertently excludes minor information or provides inconsistencies in its information, it may be given a chance to cure such deficiency. If a Proposer fails to provide material required information in its Proposal and providing the Proposer an opportunity to cure is deemed by the Company, in consultation with the Independent Observer, as an unfair advantage to such Proposer, the Proposal could be classified as non-conforming and eliminated for failure to meet Eligibility Requirements.

<sup>10</sup> The initial request will be offered 3 business days to cure. Succeeding inquiries on the deficiencies will be offered cure periods deemed sufficient by the Company and Independent Observer.

**Figure 1 – Evaluation Workflow**

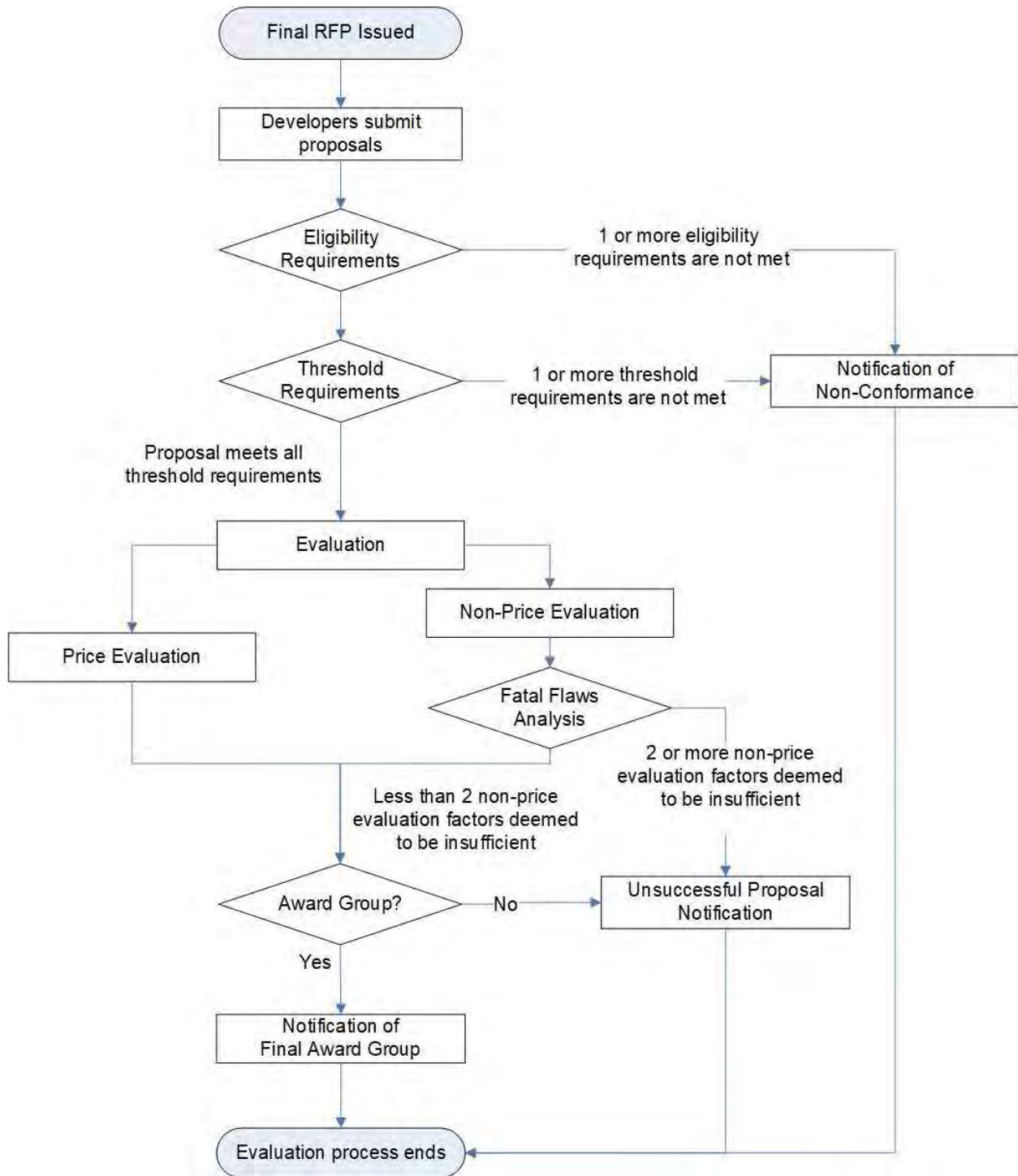

## 4.2 Eligibility Requirements Assessment

Upon receipt of the Proposals, each Proposal will be reviewed to ensure that it meets the following Eligibility Requirements.

- The Proposer is not eligible to participate in this RFP if the Proposer, its parent company, or an affiliate of the Proposer has:
  - defaulted on a current contract with the Company, or
  - had a contract terminated by the Company, or
  - any pending litigation with the Company.
- The Proposal, including required uploaded files, must be received on time via the Electronic Procurement Platform.
- The Proposal Fee must be received on time on or before the Proposal Due Date.<sup>11</sup>
- The Proposal must not contain material omissions.
- The Proposal must be signed and certified by an officer or other authorized agent of the Proposer.
- The Proposers must fully execute the NDA and any other documents required pursuant to this RFP.
- The Proposer must provide a Certificate of Vendor Compliance from the Hawai'i Compliance Express dated and issued within 60 days of the date of Proposal submission (a certificate of good standing from the State of Hawai'i Department of Commerce and Consumer Affairs and also federal and Hawai'i state tax clearance certificates for the Proposer may be substituted for the Certificate of Vendor Compliance).
- The Proposal must not be contingent upon changes to existing county, state, or federal laws or regulations.
- The Proposal must be sited on the Project Site.
- The Proposal must be for a BESS connecting to the prescribed 34kV Point of Interconnection.
- The BESS must be able to be charged from the grid at the direction of the Company as described in Section 1.2.1.
- Proposals must provide grid-forming and black start capabilities as described in Section 2.1. Proposal are to provide simulated proof, using EMT software, of such performance (i.e., frequency control, voltage control, black start) using the Company provided datasheets for the microgrid elements.
- Proposals must specify a GCOD no later than November 22, 2024.
- Proposers shall agree to post Development Period Security and Operating Period Security as described in Section 3.13.
- The Proposal must include a written attestation that states the Proposer will fulfill all requirements set forth in Section 5.3.1.

---

<sup>11</sup> Proposal Fees will not be required for Hawaiian Electric Proposals.

- The aggregated cost of the bid price of the Proposal and estimated cost of the Company's microgrid project must not exceed the estimated value of a traditional second wires path solution as described in Section 1.

### 4.3 Threshold Requirement Assessment

Proposals that meet all the Eligibility Requirements will then be evaluated to determine compliance with the Threshold Requirements, which have been designed to screen out Proposals that are insufficiently developed, lack demonstrated technology, or will impose unacceptable execution risk for the Company.

Proposals must provide explanations and contain supporting information demonstrating how and why the Project proposed meets each of the Threshold Requirements. Proposals that fail to provide this information or meet a Threshold Requirement will be eliminated from further consideration upon concurrence with the Independent Observer.

The Threshold Requirements for this RFP are the following:

1. **Performance Standards:** The proposed Project must be able to meet the performance attributes identified in this RFP and the Performance Standards identified in Section 2.1 of this RFP and Attachment B, Section 3 of the ESSA. Proposals should include sufficient documentation to support the stated claim that the Project will be able to meet the Performance Standards. The Proposal should include information required to make such a determination in an organized manner to ensure this evaluation can be completed within the evaluation review period.
2. **Proven Technology:** This criterion is intended as a check to ensure that the technology proposed is a viable technology for an energy storage project for the purposes of a microgrid of a similar MW scale for large commercial operations (ex. military bases, educational institutions, business facilities, utility plants) and can reasonably be relied upon to meet the objectives of this RFP. The Company will only consider Proposals utilizing technologies that have successfully reached commercial operations in commercial applications (i.e., a PPA) at the scale being proposed. Proposals should include any supporting information for the Company to assess the commercial and financial maturity of the technology being proposed.
3. **Experience of the Proposer:** The Proposer, its affiliated companies, partners, and/or contractors and consultants on the Proposer's Project team must have experience in financing, designing, constructing, interconnecting, owning, operating, and maintaining at least one (1) energy storage project for the purposes of a microgrid of a similar MW scale for large commercial operations (ex. military bases, educational institutions, business facilities, utility plants), similar in size, scope, technology, and structure to the Project being proposed by Proposer. The Company will consider a Proposer to have reasonably met this Threshold Requirement if the Proposer can provide sufficient information in its Proposal's RFP Appendix B, Section 2.13 tables demonstrating that at least one member of the Proposer's team (identified in the Proposal) has specific experience in each of the

following categories: financing, designing, constructing, interconnecting, owning, operating, and maintaining projects similar to the Project being proposed.

**4. Financial Compliance:** The proposed Project must not cause the Company to be subject to consolidation, as set forth in Financial Accounting Standards Board (“FASB”) Accounting Standards Codification Topic 810, Consolidation (“ASC 810”), as issued and amended from time to time by FASB. Proposers are required to state to the best of their knowledge, with supporting information to allow the Company to verify such conclusion, that the Proposal will not result in the Seller under the PPA being a Variable Interest Entity (“VIE”) and result in the Company being the primary beneficiary of the Seller that would trigger consolidation of the Seller’s finances on to the Company’s financial statements under FASB ASC 810. The Company will perform a preliminary consolidation assessment based on the Proposals received. The Company reserves the right to allow a Proposal to proceed through the evaluation process through selection of the Priority List and work with the Proposer on this issue prior to or during ESSA negotiations. The Company has determined that for purposes of FASB ASC 842, the energy storage facility will be treated as a lease. The Company would evaluate the amount of the lease that would be recorded based on the proposal submitted.

#### **4.4 Evaluation – Price and Non-Price Analysis**

Proposals that meet both the Eligibility and Threshold Requirements are Eligible Proposals which will then be subject to a price and non-price assessment. Two teams have been established to undertake the Proposal evaluation process: a Price Evaluation Team and Non-Price Evaluation Team. The results of the price and non-price analysis will be a relative ranking and scoring of all Eligible Proposals. Non-price criteria will account for sixty percent (60%) of the total score and price-related criteria will account for forty percent (40%) of the total score. The non-price criteria and methodology for applying the criteria are explained in Section 4.4.2.

The Company will employ a closed-bidding process for this solicitation in accordance with Part IV.H.3 of the Framework where the price and non-price evaluation models to be used will not be provided to Proposers. However, the Company will provide the Independent Observer with all necessary information to allow the Independent Observer to understand the evaluation models and to enable the Independent Observer to observe the entire analysis to ensure a fair process.

##### **4.4.1 Evaluation of the Price Related Criteria**

For the price analysis, a total of 400 points will be awarded. The eligible Proposal with the lowest bid price will receive 400 points. All other eligible Proposals will receive points based on a proportionate reduction using the percentage by which the eligible Proposal’s Lump Sum Payment exceeds the lowest Lump Sum Payment. For example, if a Proposal’s value is ten (10%) higher than the lowest Lump Sum Payment, the Proposal

will be awarded 360 points (that is, 400 points less 10%). The result of this assessment will be a ranking and scoring of each Proposal.

#### 4.4.2 Evaluation of the Non-Price Related Criteria

For the non-price analysis, each Proposal will be evaluated on each of the six (6) non-price criteria categories set forth below to assess their merit in the general areas of Project development feasibility and operational viability.

1. State of Project Development and Schedule
2. Performance Standards
3. Environmental Compliance and Permitting Plan
4. Experience and Qualifications
5. Financial Strength and Financing Plan
6. ESSA Contract Proposed Modifications

Each of the first two criteria – State of Project Development and Schedule and Performance Standards – will be weighted twice as heavily as the others to reflect the impact these categories have to achieve a successful and timely procurement. The non-price criteria are generally scored on a scale of 1 (poor) to 5 (highly preferable). The total non-price score will be the sum of the scores for each of the applicable individual non-price criteria. The Company will then award non-price evaluation points in accordance with the relative ranking of scores. The Proposal with the highest total non-price score will receive 400 points, and all other Proposals will receive points equal to the Proposal's score divided by the top score, multiplied by 400.

During the non-price criteria evaluation, a fatal flaws analysis will also be conducted such that any Proposal that is deemed not to meet the minimum standards level for two (2) or more applicable non-price criteria will be disqualified given that the Proposal has failed to meet the required number of non-price factors that are indicative as to the general feasibility and operational viability of a proposed Project.

The Company's evaluation of the non-price criteria will be based on the materials provided by a Proposer in its Proposal. Acceptance of any Proposal as the Awardee shall not be assumed or construed to be an endorsement or approval that the materials provided by Proposer are complete, accurate or in compliance with applicable law. The Company assumes no obligation to correct, confirm or further research any of the materials submitted by Proposers. Proposers retain sole responsibility to ensure their Proposals are accurate and in compliance with all laws.

The non-price criteria are:

1. **State of Project Development and Schedule** – Projects that are further along in development generally have lower project execution risk and a greater probability of being able to be successfully placed into service prior to the GCOD (specifically identified in each Proposal). At a minimum, Projects should demonstrate how they plan to capture any ITC safe harbor (if applicable) and reach their GCOD specified,



- including identification of risks and schedule assumptions. (Schedules must identify the IRS completion date and PUC approval dates assumed.) Proposals should also demonstrate, via a detailed critical path schedule, that there is a high likelihood that the Project will be able to reach commercial operations as specified. Proposals shall include a Gantt chart that clearly illustrates the overall schedule and demonstrates achievement of any ITC safe harbor, if applicable, and commercial operations by their specified GCOD. The Gantt chart shall include task durations and dependencies, identify tasks that will be fast tracked, and identifies slack time and contingencies. This criterion will also look at the high-level Project costs set forth in the Proposal including: costs for equipment, construction, engineering, Seller-Owned Interconnection Facilities, Company-Owned Interconnection Facilities, land, annual O&M, the reasonableness of such costs and the assumptions used for such costs. Project costs that do not appear reasonable for a project of the size proposed may result in a lower ranking for this criterion if the Company reasonably determines that the cost information is unrealistic based on prior experience in the market which may result in a risk that the Project can be built on time and for the price proposed by the Proposer. The Company reserves the right to discuss any cost and financial information with a Proposer to ensure the information provided is accurate and correct.
2. **Performance Standards:** The proposed Project must be able to meet the performance attributes identified in this RFP and the Performance Standards identified in the ESSA. The Company will review the Proposal information received, including design documents and operating procedures materials provided in the Proposal, and evaluate whether the Project as designed is able to meet the Performance Standards identified in the ESSA and in this RFP. At a minimum, in addition to meeting the Performance Standards, the Proposal should include sufficient documentation, provided in an organized manner, to support the stated claim that the Project will be able to meet the Performance Standards. The Proposal should include information required to make such a determination in an organized manner to ensure this evaluation can be completed on a timely basis. Preference will be given to Proposals that provide detailed technical and design information showing how each standard can be met by the proposed Project. Preference will also be provided on facilities that offer additional capabilities.
  3. **Environmental Compliance and Permitting Plan** – This criterion relates to the potential (short- and long-term) environmental impacts associated with each Project, the quality of the plan offered by the Proposer to mitigate and manage any environmental impacts (including any pre-existing environmental conditions), and the plan of Proposers to remain in environmental compliance over the term of the contract. These impacts are reflected on a technology-specific basis. Completing any necessary environmental review and obtaining the required permitting in a timely manner is also important and Proposals will be evaluated on their plan to identify, apply for, and secure the required permits for the Project, any permitting activity that has been completed to date, including having initial discussions with the applicable

regulating agencies such as U.S. Fish and Wildlife and the State of Hawai'i Department of Land and Natural Resources' Division of Forestry and Wildlife, prior to submitting a Proposal, and the degree of certainty offered by the Proposer in securing the necessary permits.

At a minimum, proposed Projects should be expected to have minimal environmental impact for most areas and Proposals should provide a comprehensive plan to mitigate the identified potential or actual significant environmental impacts to remain in environmental compliance. The proposed mitigation plans should be included in the Project timeline. Preference will be given to Proposals that provide a more detailed plan as well as those that have proactively taken steps to mitigate potential environmental impacts.

Also, this criterion requires that, at a minimum, Proposers should have identified, and disclosed in their Proposal(s) all major permits, approvals, appurtenances and entitlements (including applicable access, rights of way and/or easements) (collectively, the "permits") required and have a preliminary plan for securing such permits. Preference will be given to Proposals that are able to provide a greater degree of certainty that its plan to secure the required permits is realistic and achievable, or have already received all or a majority of the required permits. The Proposer should disclose all identified (a) discretionary permits required, i.e., those requiring public or contested case hearings and/or review and discretionary approval by an appropriate government agency and (b) ministerial conditions without discretionary approval conditions. In all cases, the Proposer must provide a credible and viable plan to secure all necessary and appropriate permits necessary for the Project. For example, if the Project is located within an agricultural district, the Proposer shall provide evidence of Proposer's verification with the appropriate government agency that the Project complies with HRS Section 205-2 and Section 205-4.5, relating to solar energy facilities placed on agricultural land, provided, however that where a special use permit (under Section 205-6), exemption (under Section 205-6), or amendment to land use district boundary lines (under Section 205-4) is required to secure such compliance, Proposer shall identify the need for such permit, exemption or amendment and provide a list of required prerequisites and/or conditions and a realistic timeline necessary to obtain such permit, exemption or amendment satisfactory for Proposer to still meet its designated Guaranteed Commercial Operations Date.

4. **Experience and Qualifications** – Proposals will be evaluated based on the experience of the Proposer in financing, designing, constructing, interconnecting, owning, operating, and maintaining (including all components of the project) energy storage projects for the purposes of a microgrid of a similar MW scale for large commercial operations (ex. military bases, educational institutions, business facilities, utility plants) of a similar size, scope and technology. At a minimum, Proposals must show via the table format specified in RFP Appendix B, Section 2.13 that at least one (1) member must have specific experience in each of the following categories: financing, designing, constructing, interconnecting, owning, operating, and

- maintaining at least one energy storage project for the purposes of a microgrid with grid-forming capabilities of a similar MW scale for large commercial operations project including all components of the project similar to the Project being proposed. Preference will be given to Proposers with experience in successfully developing multiple projects that are similar to the one being proposed and/or that have prior experience successfully developing and interconnecting a utility scale project to the Company's System.
5. **Financial Strength and Financing Plan** – This criterion addresses the comprehensiveness and reasonableness of the financial plan for the Project as well as assesses the financial strength and capability of the Proposer to develop the Project. A complete financial plan addresses the following issues: Project ownership, capital cost and capital structure, sources of debt and equity, and evidence that credit-worthy entities are interested in financing the Project. The financial strength of Proposers or their credit support providers will be considered, including their credit ratings. The financing participants are expected to be reasonably strong financially. Developers and their sources of capital that have investment grade credit ratings from a reputable credit rating agency (S&P, Moody's, Fitch) will also be given preference, with those that have higher credit ratings ranked higher.
  6. **ESSA Contract Proposed Modifications** – Proposers are encouraged to accept the contract terms identified in the model ESSA in its entirety in order to expedite the overall RFP process and potential contract negotiations. Proposers who accept the model ESSA without edits, will receive a higher score and will be the only proposals that can achieve the highest scoring for this non-price evaluation criterion. Technology-specific or operating characteristic-required modifications, with adequate explanation as to the necessity of such modifications, will not jeopardize a Project's ability to achieve the highest score. Proposers who elect to propose modifications to the model agreements shall provide a Microsoft Word red-line version of the applicable document identifying specific proposed modifications to the model agreement language, as well as a detailed explanation and supporting rationale for each modification. General comments without proposed alternate language, drafting notes without explanation or alternate language, footnotes such as "parties to discuss," or a reservation of rights to make additional modifications to the model agreements at a later time are unacceptable, will be considered unresponsive, and will result in a lower score. See also [Section 3.8](#). The Company and Independent Observer will evaluate the impact that the proposed modifications will have on the overall risk assessment associated with the evaluation of each Proposal.

#### **4.5 Selection of the Final Award Group**

At the conclusion of both the price and non-price analysis, a total score will be calculated for each Eligible Proposal using the 40% price-related criteria / 60% non-price-related criteria weighting outlined above. The price and non-price analysis, and the summation of both price and non-price scores described above, will result in a ranking of Proposals.

Based on the results of this Evaluation and review with the Independent Observer, the Company will select a single Proposal to the Final Award Group from which to begin contract negotiations. All Proposers will be notified at this stage of the evaluation process whether their Proposal has been awarded.

Selection to the Final Award Group and/or entering into contract negotiations does not guarantee execution of an ESSA.

Further, if at any time during the evaluation process it is discovered that a Proposer's Proposal contains incorrect or misrepresented information that have a material effect on any of the evaluation processes, including selection of the Final Award Group, the Company reserves the right, at any time prior to submission of the ESSA application with the PUC, in consultation with the Independent Observer, to disqualify the Proposer from the RFP. If discovery of the incorrect or misrepresented information is made after the Company has filed its PUC application for approval of the ESSA with the Proposer, the Company will disclose the incorrect or misrepresented information to the PUC for evaluation and decision as to whether such Proposer should be disqualified and the Company's application dismissed.

Following any removal of a Proposal from the Final Award Group, either by disqualification noted immediately above, or via any other removal or withdrawal of a Proposal, including failure to reach agreement on the ESSA, the Company, taking into consideration the timing of such removal and the current status of the Company's needs under the RFP, in consultation with and concurrence from the Independent Observer, will determine if another Proposal should be selected.

## **Chapter 5: Post Evaluation Process**

### **5.1 Interconnection Requirements Study Process**

Within 30 days after selection of the Final Award Group, final submissions, to incorporate any updates, shall be made for the following Project data and modelling submittals. A complete package of Project Interconnection Data Request worksheets, Project single line diagram(s), and three line diagram(s) shall be submitted. The models for equipment and controls, list(s) to clearly identify the components and respective files (for inverters and power plant controller), three line diagram which shows the Point of Interconnection, potential transformer (PT) and current transformer (CT) ratios, and details of the BESS facility configuration, including relays, meters, and test switches, and complete documentation with instructions, shall be submitted. See Section 2.11 of Appendix B. PSSE Generic models, PSSE User-Defined models, and ASPEN models shall be configured to represent all of the functional equipment with settings in place to comply with the Company's ESSA performance requirements. These must be checked for functionality by the Proposer or its vendors and consultants prior to submission to the Company. Similar and fully accurate PSCAD models shall be submitted in a condition that complies with the PSCAD modeling guidelines provided by the Company. PSSE generic models shall be provided promptly after the PSSE User-Defined models have been approved by the Company.

The Company will inspect the data packages for general completeness. For any incomplete submission, a list of missing or non-functional items will be provided. The Proposer will be given 15 Days to resolve data and modeling deficiencies. The Company, in consultation with the Independent Observer, may remove the Proposal from being selected to the Final Award Group or may terminate ESSA negotiations or executed ESSA, if their submission requirements are deemed incomplete for the lack of requested model. The Proposal must be complete to begin the IRS process. A formal, technical model checkout will be deferred until a later date when IRS Agreements and deposits are in place, so that the expert subject matter work can be provided by the Company's IRS consultant(s).

Upon notification of selection to the Final Award Group, the Company will provide a draft IRS Agreement for the selected Project, with a statement of required deposit for individual and prorated work as part of an IRS Scope for a System Impact Study that will involve (a) technical model checkout for the Project and (b) any considerations that are specific to the Project and location.

The technical model checkouts will be conducted first. Upon identification of any functional problems or deficiencies, corrective action shall be taken immediately and on an interactive basis so that the problems or deficiencies can be resolved within 15 Days, including re-submission of data and updated models, or the Project shall be deemed withdrawn. At the discretion of the Company and provided that there is a demonstration of good faith action to minimize delay that would affect the schedule for IRS analyses, a second round of model checkout and problem solving may proceed. Thereafter any notice that the Project is deemed withdrawn for lack of completeness shall be final. Subject to consultation with the Independent Observer, failure to provide all requested material within the time(s) specified, or changes to the data provided after the due date(s), shall result in elimination from the Final Award Group.

The Proposer shall be responsible for the cost of the IRS, under separate agreement. The overall IRS will provide information including, but not limited to, required Interconnection Facilities for a particular Project and any required mitigation measures. The Proposer will be responsible for the actual final costs of all Seller-Owned Interconnection Facilities. Upon reviewing the results of the IRS, the Proposer will have the opportunity to declare the ESSA null and void in the event that the interconnection costs and schedule for the Project are higher than what was estimated in the Project Proposal (see Section 2.3 of the ESSA).

## **5.2 Contract Negotiation Process**

Within five (5) business days of being notified by the Company of its intent to enter into contract negotiations, the Proposer selected to the Final Award Group will be required to indicate, in writing to the Company's primary contact for this RFP, whether it intends to proceed with its Proposal. The awarded Proposer will be required to keep its Proposal valid through the award period. Contract negotiations will take place in parallel with the IRS process. The Company intends to execute and file the ESSA with the PUC for approval upon completion of the Contract Negotiation Process.

### **5.3 Final Award Group Commitments**

#### **5.3.1 Community Outreach and Engagement / Cultural Resource Impacts**

The requirements described in this Section and Section 27.17 of the ESSA (Community Outreach Plan) do not represent the only community outreach and engagement activities that can or should be performed by the Proposer. Community outreach for the overall microgrid project will be managed by the Company. The selected Proposer will be required to fully cooperate with and assist the Company with community outreach efforts. This includes participating in all public meetings in which the Company requests selected Proposer's attendance, such as large community meetings, roundtables, 1:1 meetings, etc. The selected Proposer will also be required to promptly address any community concerns or issues regarding the Project BESS. The selected Proposer is expected to not only listen to community concerns, but thoughtfully consider any actions (ex. developing a list of pros and cons) and mitigate issues when necessary.

The Company will develop a cultural resource impact plan for this microgrid project. The selected Proposer will be required to comply with any requirements set forth in the cultural resource impact plan or by the Company with regard to the Project BESS. The selected Proposer will be responsible for obtaining any necessary permits required in the cultural resource plan as instructed by the Company. Additionally, the selected Proposer will be required to fully cooperate with the Company and assist with any cultural resource outreach efforts.

The Company will publicly announce the Final Award Group no more than 5 business days after the notification is given to the Proposer who is selected to the Final Award Group. The selected Proposer shall not disclose its selection to the public before the Company publicly announces the Final Award Group selection.

On the next business day after the Company notifies the Proposer they were selected, the Proposer shall provide the Company with links to their Project website, which the Company will post on the Company's website. The Proposer will launch a Project website that will go-live on the day the Company publicly announces the Final Award Group selection. Information on what should be included on the Project website is identified in Appendix B.

### **5.4 Greenhouse Gas Emissions Analysis**

The Proposer whose Proposal is selected for the Final Award Group shall cooperate with and promptly provide to the Company and/or Company's consultant(s) upon request, all information necessary, in the Company's sole and exclusive discretion, for such consultant to prepare a greenhouse gas ("GHG") emissions analysis and report in support of a PUC application for approval of the ESSA for the Project (the "GHG Review"). Proposers shall be responsible for the full cost of the GHG Review associated with their Project under a Greenhouse Gas Analysis Letter Agreement between the Proposer and the Company. The GHG Review is anticipated to address whether the GHG emissions that would result from approval of the ESSA and subsequent to addition of the Project to the

Company's system are greater than the GHG emissions that would result from the operations of the Company's System without the addition of the Project, whether the cost for energy storage services as applicable under the ESSA is reasonable in light of the potential for GHG emissions, and whether the terms of the ESSA are prudent and in the public interest in light of its potential hidden and long-term consequences.

### **5.5 PUC Approval of ESSA**

Any signed ESSA resulting from this RFP is subject to PUC approval as described in the ESSA, including Article 24 thereof.

### **5.6 Project In-Service**

In order to facilitate the timely commissioning of the Project selected through this RFP, the Company requires the following be included with the 60% design drawings: relay settings and protection coordination study, including fuse selection and ac/dc schematic trip scheme.

For the Company to test the Project, coordination between the Company and Project is required. Drawings must be approved by the Company prior to testing. The entire Project must be ready for testing to commence. Piecemeal testing will not be allowed. Communication infrastructure and equipment must be tested by the Proposer and ready for operation prior to Company testing.

If approved drawings are not available, or if the Project is otherwise not test ready as scheduled, the Company will attempt to accommodate adjustments to the schedule taking into account available personnel and other project obligations. The Proposer will be allowed to cure if successful testing is completed within the allotted scheduled time. No adjustments will be made to ESSA milestones if tests are not completed within the original allotted time. Liquidated damages for missed milestones will be assessed pursuant to the ESSA.

**DRAFT**  
**REQUEST FOR PROPOSALS**  
**FOR**  
**NORTH KOHALA**  
**ENERGY STORAGE**  
**ISLAND OF HAWAI‘I**

OCTOBER 29, 2021

Docket No. TBD

*Appendix A – Definitions*



**Hawai'i  
Electric  
Light**



“Affiliate” means any person or entity that possesses an “affiliated interest” in a utility as defined by section 269-19.5, Hawaii Revised Statutes (“HRS”), including a utility’s parent holding company but excluding a utility’s subsidiary or parent which is also a regulated utility.

“Allowed Capacity” has the meaning set forth in the ESSA.

“Back-up Power” has the meaning set forth in Section 2.1 of the RFP and the ESSA.

“Battery Energy Storage System” or “BESS” has the meaning set forth in the ESSA.

“BESS Contract Capacity” has the meaning set forth in the ESSA.

“Black-start” has the meaning set forth in Section 2.1 of the RFP and the ESSA.

“Code of Conduct” means the code of conduct approved by the PUC in Docket No. 03-0372 (Decision and Order No. 23614, August 28, 2007) with respect to a Hawaiian Electric Proposal Option.

“Code of Conduct Procedures Manual” or “Procedures Manual” means the manual being submitted to the PUC, which was put in place to address and to safeguard against preferential treatment or preferential access to information in a Hawaiian Electric, Maui Electric, or Hawaii Electric Light RFP process. The Procedures Manual is attached as Appendix C to this RFP.

“Commercial Operations” has the meaning set forth in the ESSA.

“Community Outreach Plan” is a community outreach and communication plan described in Section 4.3 of the RFP and Section 27.17 of the ESSA.

“Company” means Hawaii Electric Light Company, Inc., a Hawai‘i corporation.

“Company-Owned Interconnection Facilities” has the meaning set forth in Section 1.a of Attachment G of the ESSA.

“Competitive Bidding Framework” or “Framework” means the Framework for Competitive Bidding contained in Decision and Order No. 23121 issued by the Public Utilities Commission on December 8, 2006, and any subsequent orders providing for modifications from those set forth in Order No. 23121 issued December 8, 2006.

“Consumer Advocate” means the Division of Consumer Advocacy of the Department of Commerce and Consumer Affairs of the State of Hawai‘i.

“Day” means a calendar day, unless the term “business day” is used, which means calendar day excluding weekends and federal and State of Hawai‘i holidays.

“Development Period Security” has the meaning set forth in Section 14.2 of the ESSA.

“Dispatchable” means the ability to turn on or turn off a generating resource at the request of the utility’s system operators, or the ability to increase or decrease the output of a generating resource from moment to moment in response to signals from a utility’s Automatic Generation

Control System, Energy Management System or similar control system, or at the request of the utility's system operators.

“Electronic Procurement Platform” means the third-party web-based sourcing platform that will be used for the intake of Proposals and associated electronic information, storage and handling of Proposer information, and communication.

“Eligibility Requirements” has the meaning set forth in Section 4.2 of this RFP.

“Eligible Proposals” means Proposals that meet both the Eligibility and Threshold Requirements.

“Energy Contract Manager” is the primary Company contact for this RFP.

“Energy Storage Services Agreement” or “ESSA” means the Model Energy Storage Services Agreement attached as Appendix L to this RFP.

“Evaluation Team” means agents of the Company who evaluate Proposals.

“Facility” has the meaning set forth in the ESSA.

“Facility Study” means a study to develop the interconnection facilities cost and schedule estimate including the cost associated with the design and construction of the Company-owned interconnection facilities.

“Final Award Group” means the Proposer selected by the Company which the Company will begin contract negotiations with, based on the results of the Company's evaluation.

“Frequency Regulation” has the meaning set forth in Section 2.1 of the RFP and the ESSA.

“Greenhouse Gas” or “GHG” are gases that contribute to the greenhouse gas effect and trap heat in the atmosphere.

“Guaranteed Commercial Operations Date” or “GCOD” means the date on which a Facility first achieves Commercial Operations.

“Hawai'i Electric Light” means Hawai'i Electric Light Company, Inc., a Hawai'i corporation.

“Hawai'i Electric Light System” or “System” means the electric system owned and operated by Hawai'i Electric Light on the island of Hawai'i (including any non-utility owned facilities) consisting of power plants, transmission and distribution lines, and related equipment for the production and delivery of electric power to the public.

“Hawaiian Electric Companies” or “Companies” means Hawaiian Electric Company, Inc. and its subsidiaries, Hawai'i Electric Light Company, Inc. and Maui Electric Company, Limited.

“Hawaiian Electric Proposal” means a Proposal submitted by the Company that is responsive to the resource need identified in the RFP, as required by Section VI of the Framework.

“Hawaiian Electric Proposal Team” means agents of the Company who develop Self-Build Option proposals.

“HRS” means the Hawai‘i Revised Statutes as of the date of this Request for Proposals.

“Imputed Debt” means adjustments to the debt amounts reported on financial statements prepared under generally accepted accounting principles (“GAAP”). Certain obligations do not meet the GAAP criteria of “debt” but have debt-like characteristics; therefore, credit rating agencies “impute debt and interest” in evaluating the financial ratios of a company.

“Independent Observer” has the meaning set forth in Section 1.4 of this RFP.

“Independent Power Producer” or “IPP” means an entity that owns or operates an electricity generating facility that is not included in the Company’s rate base.

“Interconnection Facilities” means the equipment and devices required to permit a Facility to operate in parallel with, and deliver electric energy to, the Company System (in accordance with applicable provisions of the Commission’s General Order No. 7, Company tariffs, operational practices, interconnection requirements studies, and planning criteria), such as, but not limited to, transmission and distribution lines, transformers, switches, and circuit breakers. Interconnection Facilities includes Company-Owned Interconnection Facilities and Seller-Owned Interconnection Facilities.

“Interconnection Requirements Study” or “IRS” means a study, performed in accordance with the terms of the IRS Letter Agreement, to assess, among other things, (1) the system requirements and equipment requirements to interconnect the Facility with the Company System, (2) the Performance Standards of the Facility, and (3) an estimate of interconnection costs and project schedule for interconnection of the Facility.

“kV” means kilovolt.

“Levelized Benefit” or “LB” means a calculation (\$/MWh) used for comparison of Proposals based on information provided in the Proposal submission in this RFP.

“Lump Sum Payment” has the meaning set forth in the ESSA. It may also be referred to as a monthly Lump Sum Payment to reflect the portion of the payment made each month.

“Maximum Rated Output” has the meaning set forth in the ESSA.

“Mediation” means the confidential mediation conducted in Honolulu, Hawai‘i, pursuant to and in accordance with the Mediation Rules, Procedures, and Protocols of Dispute Prevention Resolution, Inc. (or its successor) or, in its absence, the American Arbitration Association then in effect.

“MW” means megawatt.

“MWh” means megawatt hour.

“NDA” means the Mutual Confidentiality and Non-Disclosure Agreement attached to this RFP as Appendix E.

“NEP” means Net Energy Potential.

“Non-Price Evaluation Team” means Employees and consultants of the Company who evaluate the Proposal non-price related criteria as set forth in Section 4.4 of this RFP. Non-Price Evaluation Team members will not include any Shared Resources and will be solely made up of Company RFP Team Members.

“O&M” means operation and maintenance.

“Operating Period Security” has the meaning set forth in Section 14.4 of the ESSA.

“Performance Standards” means the various performance standards for the operation of the Facility to the Company as set forth in Section 2.10 of Appendix B, as such standards may be revised from time to time pursuant to Article 22 of the ESSA, and as described in Chapter 2 of this RFP.

“Point of Interconnection” or “POI” has the meaning set forth in the ESSA.

“Price Evaluation Team” means Employees and consultants of the Company who evaluate the Proposal price related criteria as set forth in Section 4.4 of this RFP. Price Evaluation Team members will not include any Shared Resources and will be solely made up of Company RFP Team Members.

“Project” means a Facility proposed to Hawai‘i Electric Light by a Proposer pursuant to this RFP.

“Proposal” means a proposal submitted to Hawai‘i Electric Light by a Proposer pursuant to this RFP.

“Proposal Due Date” means the date stated in RFP Schedule for the Hawaiian Electric Proposal and for the IPP and Affiliate Proposal of this RFP.

“Proposal Fee” means the non-refundable fee for each proposal submitted as set forth in Section 1.8 of this RFP.

“Proposer” means a person or entity that submits a Proposal to Hawai‘i Electric Light pursuant to this RFP.

“Proposer’s Response Package” means the form in which the Proposal should be submitted, which is attached as Appendix B to this RFP.

“PUC” means the State of Hawai‘i Public Utilities Commission.

“Rated Active Power Capacity” has the meaning set forth in Section 2.1 of the RFP and the ESSA.

“Rated Energy Capacity” has the meaning set forth in Section 2.1 of the RFP and the ESSA.

“Renewable Portfolio Standards” or “RPS” means the Hawai‘i law that mandates that the Company and its subsidiaries generate or purchase certain amounts of their net electricity sales over time from qualified renewable resources. The RPS requirements in Hawai‘i are currently codified in HRS §§ 269-91 through 269-95.

“Request for Proposals” or “RFP” means a request for Proposals issued pursuant to a competitive bidding process authorized, reviewed, and approved by the PUC.

“RFP Schedule” means the schedule set forth in Table 1, Section 3.1 of this RFP.

“Round Trip Efficiency” or “RTE” has the meaning set forth in the ESSA.

“Seller” means the entity that the Company is contracting with, as set forth in the ESSA.

“Seller-Owned Interconnection Facilities” has the meaning set forth in the ESSA.

“Site” means the parcel of real property on which the Facility, or any portion thereof, will be constructed and located, together with any Land Rights reasonably necessary for the construction, ownership, operation, and maintenance of the Facility.

“System Impact Study” means a study analyzing the steady-state and dynamic impacts on system power flow, voltage, frequency and transient stability. The analyses includes compatibility of design, construction and operation of the Project with Company engineering standards and operating practices.

“Threshold Requirements” has the meaning set forth in Section 4.3 of this RFP.

“Voltage Regulation” has the meaning set forth in Section 2.1 of the RFP and the ESSA.

Any capitalized term not defined in this RFP has the meaning set forth in the ESSA.

**DRAFT**

**REQUEST FOR PROPOSALS**

**FOR**

**NORTH KOHALA**

**ENERGY STORAGE**

**ISLAND OF HAWAI‘I**

OCTOBER 29, 2021

Docket No. TBD

*Appendix B – Proposer’s Response Package /  
Project Interconnection Data Request*



**Hawai‘i  
Electric  
Light**

## 1.0 GENERAL INSTRUCTIONS TO PROPOSERS

The Company has elected to use the services of PowerAdvocate®, a third-party electronic platform provider. Sourcing Intelligence®, developed by PowerAdvocate®, is the Electronic Procurement Platform that the Company has licensed and will utilize for the RFP process. All Proposals and all relevant information must be submitted via the Electronic Procurement Platform, in the manner described in this RFP.

Proposers must adhere to the response structure and file naming conventions identified in this Appendix for the Proposer's response package. Information submitted in the wrong location/section or submitted through communication means not specifically identified by the Company will not be considered by the Company.

Proposers must provide a response for every item. If input/submission items in the RFP are not applicable to a specific Proposer or Proposal, Proposers must clearly mark such items as "N/A" (Not Applicable) and provide a brief explanation.

Proposers must clearly identify all confidential information in their Proposals, as described in more detail in Section 3.12 of the RFP.

All information (including attachments) must be provided in English. All financial information must be provided in U.S. Dollars and using U.S. credit ratings.

It is the Proposer's sole responsibility to notify the Company of any conflicting requirements, ambiguities, omission of information, or the need for clarification prior to submitting a Proposal.

The RFP will be conducted as a "Sealed Bid" event within Sourcing Intelligence, meaning the Company will not be able to see or access any of the Proposer's submitted information until after the event closes.

## 1.1 ELECTRONIC PROCUREMENT PLATFORM

To access the RFP event, the Proposer must register as a "Supplier"<sup>1</sup> on Sourcing Intelligence (Electronic Procurement Platform). One Proposal may be submitted with each Supplier registration.

If a Proposer is already registered on Sourcing Intelligence, the Proposer may use their current login information to submit their Proposal. Proposers are asked to refer to their chosen unique company name throughout when referring to it in text responses.

Proposers can register for an account on Sourcing Intelligence by clicking on the "Registration" button (located in the top right corner of the webpage) on the PowerAdvocate website at the following address:

[www.poweradvocate.com](http://www.poweradvocate.com)

The Proposer's use of the Electronic Procurement Platform is governed by PowerAdvocate's Terms of Use. By registering as a "Supplier" on the Electronic Procurement Platform, the Proposer acknowledges that the Proposer has read these Terms of Use and accepts and agrees that, each time the Proposer uses the Electronic Procurement

---

<sup>1</sup> The language in Appendix B sometimes refers to "Energy Contract Managers" as "Bid Event Coordinator" and to "Proposers" as "Suppliers" (Bid Event Coordinator and Supplier are terms used by PowerAdvocate).

Platform, the Proposer will be bound by the Terms of Use then accessible through the link(s) on the PowerAdvocate login page.

Once a Proposer has successfully registered as a “Supplier” with PowerAdvocate, the Proposer shall request access to the subject RFP event from the Company Contact via Email through the RFP Email address set forth in Section 1.6 of the RFP. The Email request must list the Company Name field and username under which the Proposer has registered with PowerAdvocate. After being added to the event, the Proposer will see the bid event on their dashboard upon logging into Sourcing Intelligence. Once the RFP event opens, the Proposer may begin submitting their Proposal.

After registering and prior to the opening of the RFP, Proposers are encouraged to familiarize themselves with the Electronic Procurement Platform, including tabs, the dashboard, PowerAdvocate User Information (RFP Appendix D), etc. Proposers should note that they will not be able to access any bid documents until the event officially opens.

Proposers may contact PowerAdvocate Support for help with registration or modification of registration if desired. Support is available from 8 AM to 8 PM Eastern Time (2 AM to 2 PM Hawai‘i Standard Time when daylight savings is in effect) Monday to Friday, except for Holidays posted on the PowerAdvocate website, both by phone (857-453-5800) and by Email (support@poweradvocate.com).

Contact information for PowerAdvocate Support can also be found on the bottom border of the PowerAdvocate website: [www.poweradvocate.com](http://www.poweradvocate.com)

Once the RFP event is opened, registered Proposers will have online access to general notices and RFP-related documents via the Electronic Procurement Platform. Proposers should also monitor the RFP Website throughout the RFP event.

## 1.2 PROPOSAL SUBMISSION PROCEDURES

An Email notification will be sent to all registered Proposers when the event has been opened to receive Proposals.

After logging onto the Electronic Procurement Platform, the RFP will be visible on the Proposer’s dashboard with several tabs, including the following:

- **“1. Download Documents:”** Documents stored under this tab are provided for the Proposer’s use and information. All documents can be downloaded and/or printed, as required.
- **“2. Upload Documents:”** Proposal submission documents requested in Appendix B must be uploaded using this tab.
- Note that “3. Commercial Data:”, “4. Technical Data:”, and “5. Pricing Data:” tabs are NOT USED for this event.

Step-by-step instructions for submitting a complete Proposal are provided below:

1. Proposers must upload their Proposal files, including all required forms and files, to submit a complete Proposal. All files must be uploaded before their respective Proposal Due Date (RFP Section 3.1, Table 1, Item 8 or Item 9).



2. Submit (upload) one consolidated PDF representing your Proposal via the “2. Upload Documents” tab. That Proposal PDF must abide by the format specified in this Appendix B. A MSWord.docx template that outlines the format of this document is available under the “1. Download Documents” tab for the Proposer’s use. **Response information must be provided in the order, format, and manner specified in this Appendix B and must clearly identify and reference the Appendix B section number that the information relates to.**
  - a. Proposers shall use a filename denoting: CompanyName.pdf.  
(example: AceEnergy.pdf)
  
3. Proposal information that cannot be easily consolidated into the PDF file described in Step 2 (such as large-scale drawing files) or files that must remain in native file format (such as computer models and spreadsheets) shall be **uploaded separately but must be referenced from within the main Proposal PDF file** (e.g., “See AceEnergy\_2.5\_SiteMap.kmz”). Such additional files must follow the naming convention below:
  - a. File names must include, in order, Company Name, Appendix B section number, and a file descriptor, as shown in the example file name below:  
AceEnergy\_2.5\_SiteMap.kmz  
Proposers may use abbreviations if they are clear and easy to follow.
  
4. Upload files using the "**2. Upload Documents**" tab on the Electronic Procurement Platform.
  - a. For all documents identify the "Document Type" as “Technical Information.” (Do not identify any documents as “Commercial and Administrative” or “Pricing.”)
  - b. "Reference ID" may be left blank.
  - c. Select "Choose File..." Navigate to and choose the corresponding file from your computer. Select "Open" and then "Submit Document."

There is no limit to the number or size of files that can be uploaded. Multiple files may be grouped into a .zip archive for upload. (Any zipped files must still adhere to the naming directions in #3 above.) When successfully uploaded, documents will appear under the "Bid Submissions" section on the bottom of the tab's page, organized within the “Technical Information” Document Type. Repeat steps a, b, and c, as required for each file upload.

If a file with the same name is uploaded twice, the Platform will automatically append a unique numerical extension to the Document Name. To delete a file that has been previously uploaded, click on the “X” button in the “Actions” column for the file to be deleted. Do not upload any files prior to the issuance of the Final RFP.

5. The Company will not be responsible for technical problems that interfere with the upload or download of Proposal information. Support is available to answer technical questions about PowerAdvocate’s Sourcing Intelligence from 8 AM to 8 PM Eastern Time (2 AM to 2 PM Hawai‘i Standard Time when daylight savings is in effect) Monday to Friday, except for Holidays posted on the PowerAdvocate website, both by phone (857-453-5800) and by Email (support@poweradvocate.com).

6. Proposers are strongly encouraged to start early and avoid waiting until the last minute to submit the required information. Proposers are allowed to add, modify, and/or delete documents that have been previously submitted any time prior to the event close deadline. For clarity, it is the Proposer's responsibility to ensure a complete Proposal is uploaded into PowerAdvocate before the Proposal Due Date.
7. Any questions or concerns regarding the RFP may be submitted to the Company Contact via the RFP Email address provided in Section 1.6 of the RFP. Per RFP Section 1.4.2, the Independent Observer will monitor messages within the bid event. Proposers are responsible for following instructions and uploading documents in their appropriate locations. Documents uploaded in the wrong tab will not be considered by the Company.

### 1.3 PROPOSAL COMPLETION AND CONFIRMATION PROCEDURES

To confirm the submission of all proposal files, in the "Status" tab on the Electronic Procurement Platform, confirm that the "Total Uploaded Files" is the number of expected files to be included in the submission by checking it against your list of submitted files.

Example "Status" tab view:

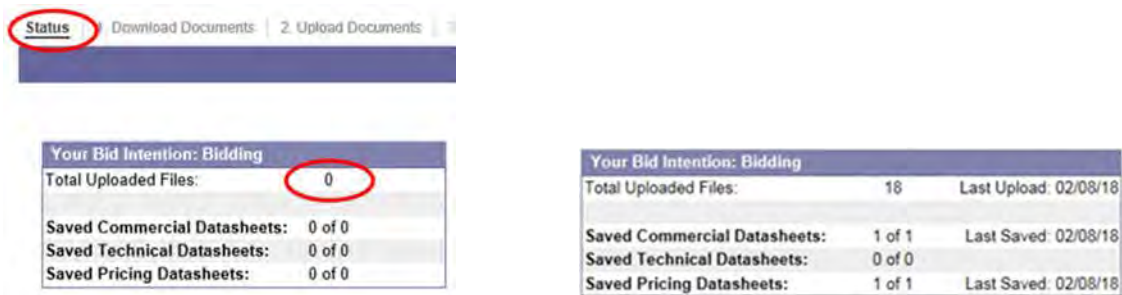

As stated above in Section 1.2, nothing should be uploaded to the Commercial, Technical, or Pricing Datasheet tabs. Documents uploaded there will not be included in your Proposal submission.

1.3.1 **Proposal Fee Delivery Information.** Provide the Proposal Fee submission information for this Proposal. Include:

- The Date the Proposal Fee was sent.
- The delivery service used and the tracking number for the parcel.
- The U.S.-chartered bank name that issued the cashier's check and the check number.

## 2.0 PROPOSAL SUMMARY TABLE

To be filled out completely by IPP or Affiliate Proposers:

1	<b>Proposer Name (Company Name)</b>	
2	<b>Parent Company/Owner/Sponsor/Business Affiliation/etc.</b>	
3	<b>Project Name</b>	
4	<b>Lump Sum Payment (\$/Year)</b>	
5	<b>Energy Storage Capability for the Facility (MW and MWh)</b>	
6	<b>The Proposer hereby certifies that Proposer will fulfill all Community Outreach and Engagement / Cultural Resource Impacts requirements identified in Section 5.3.1 of the RFP? (Yes/No)</b>	
7	<b>Proposal Guaranteed Commercial Operations Date (MM/DD/YYYY)</b>	
8	<b>The Proposer hereby certifies that the Project meets all performance attributes identified in this Section 2.1 of the RFP and Attachment B, Section 3 of the ESSA? (Yes/No)</b>	
9	<b>The Proposer hereby certifies that the Proposal (including its pricing elements) is not contingent upon changes to existing County, State, or Federal laws or regulations. (Yes/No)</b>	
10	<b>The Proposer hereby agrees to provide Development Period Security and Operating Period Security as set forth in the ESSA. (Yes/No)</b>	
11	<b>The Proposer hereby certifies under penalties of perjury that this Proposal has been made in good faith and without collusion or fraud with any other person. As used in this certification, the word “person” shall mean any natural person, business partnership, corporation, union, committee, club, or organization, entity, or group of individuals. (Yes/No)</b>	
12	<b>The Proposer hereby certifies that the Proposer, its parent company, or any affiliate of the Proposer has not either defaulted on a current contract with the Company, had a contract terminated by the Company, or has any pending litigation in which the Proposer has made claims against the Company (Yes/No)</b>	
13	<b>Does the Proposer accept the contract terms identified in the ESSA in its entirety? (Yes/No)</b>	
13a	If the response to item 13 is “No,” specify the name of the Microsoft Word red-line file that identifies the proposed modifications to the agreement, provided, however, that such proposed modifications shall be limited to targeted revisions to, and not deletions or waivers of, the agreement’s terms, conditions, covenants, requirements or representations.	

To be filled out completely by Hawaiian Electric Proposers:

1	<b>Proposer Name (Company Name)</b>		
2	<b>Parent Company/Owner/Sponsor/Business Affiliation/etc.</b>		
3	<b>Project Name</b>		
4	<b>Energy Storage Capability for the Facility (MW and MWh)</b>		
5	<b>The Proposal hereby certifies that Proposer will fulfill all Community Outreach and Engagement / Cultural Resource Impacts requirements identified in Section 5.3.1 of the RFP? (Yes/No)</b>		
6	<b>Proposal Guaranteed Commercial Operations Date (MM/DD/YYYY)</b>		
7	<b>The Proposer hereby certifies that the Project meets all performance attributes identified in Section 2.1 of the RFP and Attachment B, Section 3 of the ESSA? (Yes/No)</b>		
8	<b>The Proposer hereby certifies that the Proposal (including its pricing elements) is not contingent upon changes to existing County, State or Federal laws or regulations. (Yes/No)</b>		
9	<b>The Proposer hereby agrees to provide Development Period Security and Operating Period Security as set forth in the ESSA. (Yes/No)</b>		
10	<b>The Proposer hereby certifies under penalties of perjury that this Proposal has been made in good faith and without collusion or fraud with any other person. As used in this certification, the word “person” shall mean any natural person, business partnership, corporation, union, committee, club, or organization, entity, or group of individuals. (Yes/No)</b>		
11	<b>Year (YYYY)</b>	<b>Project Capital Cost (\$)</b>	Extend the table for questions 11, 12, and 13 for as many years as needed up to the 10-year ESSA term.
12	<b>Year (YYYY)</b>	<b>O&amp;M Cost (\$)</b>	
13	<b>Year (YYYY)</b>	<b>Annual Revenue Requirement (\$)</b>	

## 2.1 REQUIRED FORMS ACCOMPANYING PROPOSAL PDF

The following forms must accompany each proposal, must be attached to the Proposal PDF, and uploaded via the “2. Upload Documents” tab:

- Document signed by a representative for the Proposer **authorizing the submission** of the Proposal
- Fully executed **Mutual Confidentiality and Non-Disclosure Agreement (“NDA”)** ([Appendix E](#) to the RFP, may be downloaded from the “1. Download Documents” tab in the Electronic Procurement Platform).
- **Certificate of Vendor Compliance** for the Proposer
  - **Certificate of Good Standing** for the Proposer and **Federal and State tax clearance certificates** for the Proposer may be provided in lieu of the Certificate of Vendor Compliance
- **Certification of Counsel for Proposer**, if applicable. (See [Appendix B Attachment 1.](#))
- Completed applicable **Project Interconnection Data Request worksheet** for the proposed technology and **project single line diagram(s). Models for equipment and controls, list(s)** identifying components and **respective files** (for inverters and power plant controller), and **complete documentation with instructions** as specified in the Data Request worksheet shall be submitted within the respective timeframes specified in [Section 5.1](#) of the RFP.<sup>2</sup> (See [Section 2.11.1](#) below)
- [For Hawaiian Electric Proposals Only] **Hawaiian Electric Proposal Team Certification Form**. See [Appendix G Attachment 1.](#)
- [For Hawaiian Electric Proposals Only] **Revenue Requirements Worksheets** that support the annual revenue requirements estimates shall be submitted. A starter revenue requirements template file can be requested by the Hawaiian Electric Proposal Team via email to the RFP Email Address or through the PowerAdvocate Messaging function once the RFP event opens. The revenue requirements worksheets submitted will be modified to reflect the details of the Project’s Proposal. All assumptions used will be reflected in an assumptions input tab.

## 2.2 PROPOSAL SUMMARY/CONTACT INFORMATION

2.2.1 Provide a **primary point of contact** for the Proposal being submitted:

- Name
- Title
- Mailing Address
- Phone Number
- Email Address - this will be the official communication address used during the RFP process

2.2.2 **Executive Summary of Proposal.** The executive summary must include an approach and description of the important elements of the Proposal.

---

<sup>2</sup> If the Models, lists, respective files and complete documentation are not submitted with the Proposal upload, they shall be submitted via PowerAdvocate’s Messaging as attachments within the respective timeframes specified in [Section 5.1](#) of the RFP.

2.2.3 **Pricing information.** Pricing information must be filled out in the Section 2.0 Proposal Summary Table above. Provide any pricing information only in those table sections – do not embed pricing information in any other portion of the Proposal PDF.

2.2.4 Provide a **high-level overview of the proposed Facility**, including at a minimum the following information:

- Technology Type (i.e. lithium ion battery)
- Maximum Rated Output, as defined in the applicable contract (MW)
- Discharge Duration at Maximum Rated Output (hours)
- Storage Energy Capacity (MWh) available at the point of interconnection (i.e. BESS Contract Capacity as defined in the applicable contract)
- Operational Limitations, such as, but not limited to: energy throughput limits (daily, monthly, annually), State of Charge restrictions (min/max SOC while at rest (not charging/discharging)), etc. Proposed Operational Limits cannot be in conflict with the energy discharge requirement in Section 1.2.7 of the RFP. If such a conflict is identified, the Proposal may be disqualified.
- Round Trip Efficiency (“RTE”) Specify a single value (percentage) that the Facility is required to maintain throughout the term of the ESSA. The RTE must consider and reflect:
  - the technical requirements of the Facility (as further set forth in the applicable contract);
  - that the measurement location of charging and discharged energy is at the point of interconnection;
  - electrical losses associated with the point of interconnection measurement location;
  - any auxiliary and station loads that need to be served by BESS energy during charge and discharge that may not be done at Maximum Rated Output or over a fixed duration; and
  - that the data used to validate the RTE will be captured during a full charge cycle (0%-100% SOC) directly followed by a full discharge cycle (100%-0% SOC).
- Describe any augmentation plans for the storage component to maintain the functionality and characteristics of the storage during the term of the applicable contract. Include any expected interval of augmentation (months/years).
- Estimated useful life of the storage component (including augmentation if used) (years).

## 2.3 FINANCIAL

Provide the following financial information identified below. As specified in the General Instructions in Section 1.0 above, all information (including attachments) must be provided in English, be provided in U.S. Dollars and use U. S. credit ratings.

2.3.1 Identification of Equity Participants

2.3.1.1 Who are the **equity participants** in the Project (or the equity partners’ other partners)?

2.3.1.2 Provide an **organizational structure** for the Proposer including any general and limited partners and providers of capital that identifies:

- Associated responsibilities from a financial and legal perspective
- Percentage interest of each party

2.3.2 Project Financing

2.3.2.1 **How will the Project be financed** (including construction and term financing)? Address at a minimum:

- The Project's projected financial structure
- Expected source of debt and equity financing

2.3.2.2 [For IPP and Affiliate Proposals] Identify all **estimated development and capital costs** for, at a minimum:

- Equipment
  - Identify the manufacturer and model number for all major equipment
- Construction
- Engineering
- Seller-Owned Interconnection Facilities
- Land
- Annual O&M
- Specify a percentage of the total project cost that is estimated to be attributed to the storage functionality of the Facility. As the storage functionality is treated as a lease, the Company will use the percentage for its preliminary calculation of the lease liability only. This percentage requested for the Company's accounting purposes does not affect nor alter the liquidated damage provisions of the ESSA, as those provisions reflect the benefit the Company seeks from the Project's storage functionality.

[For Hawaiian Electric Proposals Only] Identify all **estimated development and capital costs** for, at a minimum:

- Facility (including any generation and storage components)
- Outside Services
- Interconnection
- Overhead Costs
- Allowance for Funds Used During Construction
- Annual O&M
- Specify a percentage of the total project cost that is estimated to be attributed to the storage functionality of the Facility. As the storage functionality is treated as a lease, the Company will use the percentage for its preliminary calculation of the lease liability only. This percentage requested for the Company's accounting purposes does not affect nor alter the liquidated damage provisions of the ESSA, as those provisions reflect the benefit the Company seeks from the Project's storage functionality.

2.3.2.3 Discuss and/or provide **supporting information on any project financing guarantees**.

2.3.2.4 Describe any **written commitments obtained from the equity participants**.

2.3.2.5 Describe any **conditions precedent to project financing**, and the Proposer's plan to address them, other than execution of the Energy Storage Services Agreement or any other applicable project

agreements and State of Hawai'i Public Utilities Commission approval of the Energy Storage Services Agreement and other agreements.

2.3.2.6 Provide any **additional evidence to demonstrate that the Project is financeable**.

2.3.3 Project Financing Experience of the Proposer

Describe **the project financing experience of the Proposer** in securing financing for projects of a similar size (i.e., no less than two-thirds the size) and technology as the one being proposed including the following information for any referenced projects:

- Project Name
- Project Technology
- Project Size
- Location
- Date of Construction and Permanent Financing
- Commercial Operations Date
- Proposer's Role in Financing of the Project
- Off-taker
- Term of the Interconnection Agreement
- Financing Structure
- Major Pricing Terms
- Name(s) of Finance Team Member(s); Time (i.e., years, months) worked on the project and Role/Responsibilities

2.3.4 Evidence of the Proposer's Financial Strength

2.3.4.1 Provide **copies of the Proposer's audited financial statements** (balance sheet, income statement, and statement of cash flows):

- Legal Entity
  - Three (3) most recent fiscal years
  - Quarterly report for the most recent quarter ended
- Parent Company
  - Three (3) most recent fiscal years
  - Quarterly report for the most recent quarter ended

2.3.4.2 Provide the **current credit ratings** for the Proposer (or Parent Company, if not available for Proposer), affiliates, partners, and credit support provider:

- Standard & Poor's
- Moody's
- Fitch

2.3.4.3 Describe any **current credit issues** regarding the Proposer or affiliate entities raised by rating agencies, banks, or accounting firms.

2.3.4.4 Provide any **additional evidence that the Proposer has the financial resources and financial strength** to complete and operate the Project as proposed.



2.3.5 Provide evidence that the Proposer can provide the required securities

2.3.5.1 Describe the Proposer's **ability (and/or the ability of its credit support provider) and proposed plans to provide the required securities** including:

- Irrevocable standby letter of credit
- Sources of security
- Description of its credit support provider

2.3.6 Disclosure of Litigation and Disputes

Disclose any **litigation, disputes, and the status of any lawsuits or dispute resolution** related to projects owned or managed by the Proposer or any of its affiliates.

2.3.7 State to the best of the Proposer's knowledge: Will the Project result in **consolidation** of the Developer entity's finances onto the Company's financial statements under FASB 810. **Provide supporting information** to allow the Company to verify such conclusion.

## 2.4 CONTRACT EXCEPTIONS AND FINANCIAL COMPLIANCE

2.4.1 If Proposers elect to propose modifications to the ESSA, **provide a Microsoft Word red-line version of the ESSA** identifying specific proposed modifications to the model language that the Proposer is agreeable to and a detailed explanation and supporting rationale for each modification. General comments, drafting notes, and footnotes such as "parties to discuss" are unacceptable and will be considered non-responsive.

Proposers that do not upload redlines of the ESSA with their Proposal submission will be deemed to have accepted the ESSA in its entirety. If no modifications are proposed, please state in this section "no modifications to the ESSA".

As set forth in RFP Section 3.8.5.1, proposed modifications to the ESSA will be subject to negotiation between the Company and the Final Award Group and should not be assumed to have been accepted either as a result of being selected to the Final Award Group or based on any previously executed PPA.

## 2.5 AKONI PULE SITE INFORMATION

2.5.1 Provide a **site layout plan** which illustrates:

- Proposed location of all equipment
- Proposed location of all facilities on the Akoni Pule Site, including any proposed line extensions
- Site boundaries (if the proposed Project does not cover the entire Akoni Pule Site)

2.5.2 Describe the **Interconnection route** and include:

- Site sketches of how the facility will be interconnected to the Company's System (above-ground and/or underground)
- Description of the rationale for the interconnection route

## 2.6 ENVIRONMENTAL COMPLIANCE AND PERMITTING PLAN

Scoring of proposals for the non-price evaluation criteria of this section will be based on the completeness and thoroughness of responses to each of the criteria listed below. The Company recommends that each Proposal incorporate the list below as an outline together with complete and thorough responses to each item in the list. Proposals that closely follow this recommendation will typically be awarded higher scores than proposals that do not.

2.6.1 Describe your **overall land use and environmental permits and approvals strategy** and approach to obtaining successful, positive results from the agencies and authorities having jurisdiction, including:

- Explanation of the conceptual plans for siting
- Studies/assessments
- Permits and approvals
- Gantt format schedule which identifies the sequencing of permit application and approval activities and critical path. (Schedule must be in MM/DD/YY format.)

2.6.2 Discuss the **city zoning and state land use classification**:

- Identify present and required zoning and the ability to site the proposed Project within those zoning allowances.
- Identify present and required land use classifications and the ability to site the proposed Project within those classifications.
- Provide evidence of proper zoning and land use classifications for selected site and interconnection route.
- If changes in the above are required for the proposed Project, provide a plan and timeline to secure the necessary approvals.

2.6.3 Identify all required discretionary and non-discretionary **land use, environmental and construction permits, and approvals** required for development, financing, construction, and operation of the proposed Project, including but not limited to zoning changes, Environmental Assessments, and/or Environmental Impacts Statements.

Provide a **listing of such permits and approvals** indicating:

- Permit Name
- Federal, State, or Local agencies and authorities having jurisdiction over the issuance
- Status of approval and anticipated timeline for seeking and receiving the required permit and/or license
- Explanation of your basis for the assumed timeline
- Explain any situation where a permit or license for one aspect of the Project may influence the timing or permit of another aspect (e.g., a case where one permit is contingent upon completion of another permit or license), if applicable.
- Explain your plans to secure all permits and approvals required for the Project.

2.6.4 Provide a **preliminary environmental assessment of the site** (including any pre-existing environmental conditions) and potential short- and long-term **impacts** associated with, or resulting from, the proposed Project – including direct, indirect, and cumulative impacts associated with development, construction, operation, and maintenance of the proposed Project in every area identified below. Discuss if alternatives have been or will be considered. The assessment shall also include Proposer's short- and long-

term plans to mitigate such impacts and explanation of the mitigation strategies for, but not limited to, each of the major environmental areas as presented below:

- Natural Environment
  - Air quality
  - Biology (Natural habitats and ecosystems, flora/fauna/vegetation, and animals, especially if threatened or endangered)
  - Climate
  - Soils
  - Topography and geology
- Land Regulation
  - Land Uses, including any land use restrictions and/or pre-existing environmental conditions/contamination
  - Flood and tsunami hazards
  - Noise
  - Roadways and Road and Air Traffic
  - Utilities
- Socio-Economic Characteristics
- Aesthetic/Visual Resources and Impact
- Solid Waste
- Hazardous Materials
- Water Quality
- Public Safety Services (Police, Fire, Emergency Medical Services)
- Recreation
- Potential Cumulative and Secondary Impacts

2.6.5 Provide a **decommissioning plan**, including:

- Developing and implementing program for recycling to the fullest extent possible, or otherwise properly disposing of installed infrastructure, if any, and
- Demonstrating how restoration of the Site to its original ecological condition is guaranteed in the event of default by the Proposer in the applicable Site Control documentation.

## 2.7 RESERVED

## 2.8 WEBSITE INFORMATION

2.8.1 Proposer selected to the Final Award Group must display the below table of information on their Project website described in Section 5.3 of the RFP to provide communities Project information that is of interest to them in a standard format.

### PROJECT SUMMARY AND COMMUNITY OUTREACH PLAN

*	Proposer Name (Company name)	
*	Parent Company/Owner/Sponsor/Business Affiliate/etc.	
*	Project Name	
*	Net AC Capacity of the Facility (MW) (must match Proposal information)	

*	Proposed Facility Location, Street Address if available, or what City/Area on the island it is near	
*	TMK(s) of Facility Location (must match Proposal information)	
*	Point of Interconnection's Circuit (must match Proposal information)	
*	Project Description (in 200 words or less)	<i>(A description that includes information about the project that will enable the community to understand the impact that the Project might have on the community.)</i>
*	Project site map	<i>(provide a map similar to what was provided in Section 2.5.2)</i>
*	Site layout plan	<i>(provide a layout similar to what was provided in Section 2.5.3)</i>
*	Interconnection route	<i>(provide a map of the route similar to what was provided in Section 2.5.4)</i>
<b>Environmental Compliance and Permitting Plan</b>		
*	Overall land use and environmental permits and approvals strategy	<i>(provide information in level of detail as provided in Section 2.6.1)</i>
*	Gantt format schedule which identifies the sequencing of permit applications and approval activities and critical path. Schedule must be in MM/DD/YY format)	<i>(provide information in level of detail as provided in Section 2.6.1)</i>
*	City Zoning and Land Use Classification	<i>(provide information in level of detail as provided in Section 2.6.2)</i>
*	Discretionary and non-discretionary Land use, environmental and construction permits and approvals	<i>(provide information in level of detail as provided in Section 2.6.3)</i>
*	Listing of Permits and approvals	<i>(provide information in level of detail as provided in Section 2.6.3)</i>
*	Preliminary environmental assessment of the Site (including any pre-existing environmental conditions)	<i>(provide information in level of detail as provided in Section 2.6.4)</i>

## 2.9 OPERATIONS AND MAINTENANCE (O&M)

2.9.1 To demonstrate the long-term operational viability of the proposed Project, describe the **planned operations and maintenance**, including:

- Operations and maintenance funding levels, annually, throughout the term of the contract.

- Description of the operational requirements by frequency (daily, weekly, monthly, yearly, as-necessary, run hour interval) and maintenance requirements by frequency (daily, weekly, monthly, yearly, as-necessary, run hour interval).
- A discussion of the staffing levels proposed for the Project and location of such staff. If such staff is offsite, describe response time and ability to control the Project remotely.
- Technology specific maintenance experience records.
- Identification of any O&M providers.
- The expected role of the Proposer (Owner) or outside contractor.
- Scheduling of major maintenance activity.
- Plan for testing equipment.
- Estimated life of Storage Facilities and associated Interconnection Facilities.
- Safety plan, including historical safety records with environmental history records, violations, and compliance plans.
- Security plan.
- Site maintenance plan.
- Substation equipment maintenance plan.

2.9.2 State whether the Proposer would **consider 24-hour staffing**. Explain how this would be done.

2.9.3 Describe the **Proposer's contingency plan**, including the Proposer's mitigation plans to address failures. Such information should be described in the Proposal to demonstrate the Project's reliability with regard to potential operational issues.

2.9.4 Describe if the Proposer will **coordinate their maintenance schedule** for the Project with the Company's annual planned generation maintenance. See Article 5 of the ESSA.

2.9.5 Describe the **status of any O&M agreements or contracts** that the Proposer is required to secure. Include a discussion of the Proposer's plan for securing a long-term O&M contract.

2.9.6 Provide **examples of the Proposer's experience** with O&M services for other similar projects.

## 2.10 PERFORMANCE STANDARDS

2.10.1 Design and operating information. Provide a **description of the project design**. Description shall include:

- Configuration description, including conceptual or schematic diagrams. Overview of the Facility Control Systems – central control and inverter- or resource-level control.
- Diagrams approved by a Professional Electrical Engineer registered in the State of Hawai'i, indicated by the presence of the Engineer's Professional seal on all drawings and documents. Including but not limited to:
  - A single-line diagram, relay list, trip scheme and settings of the generating facility, which identifies the Point of Interconnection, circuit breakers, relays, switches, synchronizing equipment, monitoring equipment, and control and protective devices and schemes.

2.10.2 **Capability of Meeting Performance Standards.** The proposed Facility must meet the performance attributes identified in Section 2.1 of the RFP and Attachment B, Section 3 of the ESSA. Provide **confirmation that the proposed Facility will meet the requirements identified** or provide clarification or comments about the Facility's ability to meet the performance standards. Proposals should include sufficient documentation to support the stated claim that the Facility will be able to meet the Performance Standards. The Proposal should include information required to make such a determination in an organized manner to ensure this evaluation can be completed within the evaluation review period.

2.10.3 **Reactive Power Control:** Provide the facility's **ability to meet the Reactive Power Control capabilities**, including Voltage Regulation at the point of interconnection, required in the Performance Standards, including contribution from the energy storage inverters and means of coordinating the response. Provide the inverter capability curve(s). Confirm ability to provide reactive power at zero active power.

2.10.4 **Undervoltage ride-through:** Provide the facility's terminal voltage level(s) and elapsed time at which the facility will disconnect from the utility system during the disturbance, if any. Confirm the ability to meet ride-through requirements and include supporting documentation regarding inverter design, control parameters, etc.

2.10.5 **Overvoltage ride-through:** Provide the facility's terminal voltage level(s) and elapsed time at which the facility will disconnect from the utility system during the disturbance, if any. Confirm the ability to meet ride-through requirements and include supporting documentation regarding inverter design, control parameters, etc.

2.10.6 **Transient stability ride-through:** Provide the facility's ability to stay online during Company System: (1) three-phase fault located anywhere on the Company System and lasting up to \_\_ cycles; and (2) a single line to ground fault located anywhere on the Company System and lasting up to \_\_ cycles. Provide the Facility's ability to withstand subsequent events.

2.10.7 **Underfrequency ride-through:** Provide the facility's terminal frequency level(s) and elapsed time at which the facility will disconnect from the utility system during the disturbance, if any. Confirm the ability to meet ride-through requirements and include supporting documentation regarding inverter design, control parameters, etc.

2.10.8 **Overfrequency ride-through:** Provide the facility's terminal frequency level(s) and elapsed time at which the facility will disconnect from the utility system during the disturbance, if any. Confirm the ability to meet ride-through requirements and include supporting documentation regarding inverter design, control parameters, etc.

2.10.9 **Frequency Response:** Provide the facility's frequency response characteristics as required by the RDG PPA, including time of response, tunable parameters, alternate frequency response modes, and means of implementing such features.

2.10.10 **Auxiliary Power Information:** Proposer must provide the maximum auxiliary power requirements for:

- Start-up

- Normal Operations (from generator)
- Normal Operating Shutdown
- Forced Emergency Shutdown
- Maintenance Outage

2.10.11 **Coordination of Operations:** Provide a description of the control facilities required to coordinate generator operation with and between the Company's System Operator and the Company's System.

- Include a description of the equipment and technology used to facilitate dispatch to the Company and communicate with the Company.
- Include a description of the control and protection requirements of the generator and the Company's System.

2.10.12 **Cycling Capability:** Describe the Facility's ability to cycle on/off and provide limitations.

2.10.13 **Active Power Control Interface:** Describe the means of implementing active power control and the Power Possible, including the contribution to the dispatch signal from paired storage, if any. Provide the Proposer's **experience** dealing with active power control, dispatch, frequency response, and ride-through.

2.10.14 Provide the details of the **major equipment** (i.e., batteries, inverters, battery management system), including, but not limited to, name of manufacturer, models, key metrics, characteristics of the equipment, and performance specifications.

2.10.15 **Energy Storage performance standards:** Provide additional performance standard descriptions as follows:

- MWh storage output for a full year
- Ramp Rate: Provide the Facility's ramp rate, which should be no more than 2 MW/minute for all conditions other than those under control of the Company System Operator and/or those due to desired frequency response.
- System Response Time – Idle to Design Maximum (minutes)
- Discharge Start-up time (minutes from notification)
- Charge Start-up time (minutes from notification)
- Start and run-time limitations, if any

## 2.11 INTERCONNECTION SUBMITTAL REQUIREMENTS

2.11.1 A summary of the model requirements and impact study scope can be found in Appx B Att 4 from the "1. Download Documents" tab.

2.11.2 Provide the completed **Project Interconnection Requirement Study Data Request worksheet** with the Proposal submission. The worksheet can be found in the "1. Download Documents" tab as Appx B Att 2 with the file name of Project Interconnection Data Request Worksheets (storage) MSEXcel files. Also provide all **project diagram(s)** with the Proposal submission. **Models for equipment and controls, list(s)** identifying components and **respective files** (for inverters and power plant controller), and **complete**

**documentation with instructions** shall be submitted within the timeframes specified in Section 2.3.2 of the RFP.<sup>2</sup> Proposers may also download the Facility Technical Model Requirements and Review Process documentation labelled as Appx B Att 3 from the “1. Download Documents” tab.

## 2.12 PROVEN TECHNOLOGY

2.12.1 Provide all supporting information for the Company to assess the **commercial and financial maturity of the technology** being proposed. Provide any supporting documentation that shows examples of projects that:

- Use the technology at the scale being proposed
- Have successfully reached commercial operations (for example, by submitting a PPA)
- Demonstrate experience in providing Active Power dispatch

## 2.13 EXPERIENCE AND QUALIFICATIONS

Proposers, its affiliated companies, partners, and/or contractors and consultants are required to demonstrate project experience and management capability to successfully develop and operate the proposed Project.

2.13.1 Provide a hierarchical **organizational / management chart** for the Project that lists all key personnel and project participants dedicated to this Project and that identifies the management structure and responsibilities. In addition to the chart, Proposers must provide biographies / resumes of the key personnel, including position, years of relevant experience and similar project experience. Proposers must provide specifics as they relate to financing of renewable energy projects. Identify architects and engineers or provision to provide same that are licensed to practice in the State of Hawaii. Providers must also provide a completed table:

- For each of the project participants (including the Proposer, partners, and proposed contractors), fill out the table below and provide statements that list the specific experience of the individual in: financing, designing, constructing, interconnecting, owning, operating, and maintaining renewable energy generating or storage facilities, or other projects of similar size and technology, and
- Provide any evidence that the project participants have worked jointly on other projects.

<b>EXPERIENCE:</b>							
In the applicable columns below, include project details (i.e., project name, location, technology, size) and relevant job duties (role/responsibilities) and time (in years/months) spent on the project. List multiple projects if applicable.							
Participant Name:	Financing	Designing	Constructing	Interconnecting	Owning	Operating	Maintaining
1.							
2.							
3.							
...							



2.13.2 Identify those **member(s) of the team** the Proposer is submitting to meet the experience and qualifications requirement, including the Threshold Requirement. Identify those **members of the team with experience and qualifications**, including affiliates, and their principal personnel who will be involved in the project. If the Proposer consists of multiple parties, such as joint ventures or partnerships, demonstrate each member(s) firm commitment to provide services to the project (e.g., letter of intent); provide this information for each party, clearly indicating the proposed role of each party, including an ownership chart indicating direct and indirect ownership, and percentage interests in the partnership or joint venture.

2.13.3 Provide a **listing in the table format below, of all energy storage projects for the purposes of a microgrid of a similar MW scale for large commercial operations (ex. military bases, educational institutions, business facilities, utility plants)** the Proposer has successfully developed or that are currently under construction. Describe the Proposer’s role and responsibilities associated with these projects (lead developer, owner, investor, etc.). Provide the following information as part of the response:

Project Name	Location (City, State)	Storage Technology	Size (MW/ MWh)	Commercial Operation Date	Offtaker (if applicable)	Role & Responsibilities
1.						
2.						
3.						
...						

## 2.14 STATE OF PROJECT DEVELOPMENT AND SCHEDULE

2.14.1 Provide a **project schedule in GANTT chart format** with complete **critical path activities** identified for the Proposal from the Notice of Selection of the Proposal to the start of Commercial Operations.

- The **schedule** must include:
  - Interconnection Requirement Study (IRS) assumptions
  - Anticipated contract negotiation period assumptions
  - Regulatory assumptions
  - Anticipated submittal and approval dates for permitting (including but not limited to environmental and archaeological compliance)
  - Cultural Resource implications and mitigation activities
  - Community outreach and engagement activities
  - Energy resource assessment
  - Financing
  - Engineering
  - Procurement
  - Facility construction including construction management events
  - Applicable reporting milestone events specified in the ESSA
  - Testing
  - Interconnection (including engineering, procurement, and construction)
  - Commercial Operations Date
  - All other important elements outside of the direct construction of the Project

- For each project element, list the start and end date (must be in MM/DD/YY format), and include predecessors to clearly illustrate schedule dependencies and durations.
- Proposers must also list and describe critical path activities and milestone events, particularly as they relate to the integration and coordination of the project components and the Company's Electric System. Proposers must ensure that the schedule provided in this section is consistent with the milestone events contained in the ESSA and/or other agreements.

2.14.2 Describe the **construction execution strategy** including:

- Identification of contracting/subcontracting plans
- Modular construction
- Safety plans<sup>3</sup>
- Quality control and assurance plan
- Labor availability
- Likely manufacturing sites and procurement plans
- Similar projects where these construction methods have been used by the Proposer.

2.14.3 Provide a description of any **project activities that have been performed to date**.

2.14.4 Explain how you plan to reach **safe harbor milestones** (if applicable) and **guaranteed commercial operations**, including durations and dependencies which support this achievement.

---

<sup>3</sup> A document that describes the various safety procedures and practices that will be implemented on the Project and how applicable safety regulations, standards, and work practices will be enforced on the Project.

**Certification of Counsel for Proposer  
Hawaiian Electric Company, Inc., Maui Electric Company, Ltd, and Hawai'i Electric  
Light Company, Inc.**

Pursuant to Section 1.7.4 of Hawaiian Electric Company, Inc., Hawai'i Electric Light Company, Inc. and Maui Electric Company, Limited's (each a "Company" and collectively, the "Companies") Request For Proposals for Energy Storage, North Kohala, Island of Hawai'i ("RFP"), the Companies may require legal counsel who represent multiple unaffiliated proposers to sign a certification that they have not shared confidential information obtained through the representation of one proposer with any other unaffiliated proposer.

Accordingly, by signing below, I hereby acknowledge, agree and certify that:

(1) in connection with the RFP, I represent the following company that has submitted a proposal(s) for the RFP: \_\_\_\_\_ ("Proposer");

(2) irrespective of any proposer's direction, waiver or request to the contrary, I will not share a proposer's confidential information or the Company's confidential information associated with such proposer, including, but not limited to, a proposer's or Company's negotiating positions, with third parties unaffiliated with Proposer (by contract or organizational structure), including other proposers responding to the RFP;

(3) the Companies may rely on this certification for purposes of the RFP; and

(4) at the conclusion of power purchase agreement negotiations, if any, the Company may require me to sign a certificate certifying that I have not shared a proposer's confidential information or the Company's confidential information associated with such proposer, including, but not limited to, a proposer's or Company's negotiating positions, with third parties unaffiliated with Proposer (by contract or organizational structure), including other proposers responding to the RFP.

\_\_\_\_\_  
Name (print)

\_\_\_\_\_  
Law Firm (if applicable)

\_\_\_\_\_  
Signature

\_\_\_\_\_  
Date

Section 1.7.4 of the RFP provides in relevant part that:

In submitting a Proposal in response to this RFP, each Proposer certifies that the Proposal has been submitted in good faith and without fraud or collusion with any other unaffiliated person or entity. The Proposer shall acknowledge this in the Response Package submitted with its Proposal. Furthermore, in executing the NDA provided as Appendix E, the Proposer agrees on behalf of its Representatives (as defined in the NDA) that the Company's negotiating positions will not be shared with other Proposers or their respective Representatives.

In addition, in submitting a Proposal, a Proposer will be required to provide Company with its legal counsel's written certification in the form attached as Appendix B Attachment 1 certifying in relevant part that irrespective of any proposer's direction, waiver, or request to the contrary, that the attorney will not share a proposer's confidential information associated with such Proposer with others, including, but not limited to, such information such as a Proposer's or Company's negotiating positions.

**Project Interconnection - Data Request**

**FOR STORAGE**

**PROJECT:** \_\_\_\_\_

**DATE:** \_\_\_\_\_

**(Nonexclusive Preliminary List)**

**\*\*\*ALL ITEMS ARE REQUIRED AND ALL RESPONSES MUST BE FILLED UNLESS NOT APPLICABLE.\*\*\***

		Response
1)	Please provide a plan map of the Renewable Generation facility. Please indicate the interconnection point to the HECO system.	
2)	<p>Please provide the following generation and load information for the Renewable Generation facility:</p> <p>a. Gross and net output of the facility</p> <p>b. Expected KW and KVAR loads including, but not limited to, generators' auxiliary load curve, process load(s) profile(s), etc.</p> <p>c. Expected minimum and maximum MW and MVAR "import from" AND "export to" HECO.</p>	
3)	<p>Please provide Single-Line Diagram(s), Three-Line Diagram(s), and Protective Relay List &amp; Trip Schedule for the generation and interconnection facilities:</p> <p>a. The Single-line diagram(s) and Three-line diagram (s) should include:</p> <p style="margin-left: 20px;">i. For main and generator step up transformer(s), please show:</p> <ul style="list-style-type: none"> <li>• Transformer voltage and MVA ratings.</li> <li>• Transformer impedance(s).</li> <li>• Transformer winding connections and grounding. If neutrals are grounded through impedance, please show the impedance value.</li> </ul> <p style="margin-left: 20px;">ii. The protective relaying and metering for the generators, transformers, buses, and all other main substation equipment.</p> <p style="margin-left: 20px;">iii. For the potential transformers, please indicate the type, quantity, ratio, and accuracy rating.</p> <p style="margin-left: 20px;">iv. For the current transformers, please indicate the type, quantity, ratio, and accuracy rating, and thermal rating factor.</p> <p style="margin-left: 20px;">v. Auxiliary power devices (e.g. capacitors, reactors, storage systems, etc.) and their rating(s); additional inquiries may be made to obtain technical data for these devices.</p> <p style="margin-left: 20px;">vi. For the interconnection / tie lines (overhead or underground) and the plant's generation system, please provide the following, as applicable:</p> <ul style="list-style-type: none"> <li>• Installation details such as cross-section(s), plan and profiles, etc.</li> <li>• Conductor data such as size, insulation, length etc.</li> <li>• Continuous and emergency current ratings.</li> <li>• Voltage rating (nominal and maximum KV).</li> <li>• BIL rating.</li> <li>• Positive, negative, and zero-sequence impedances (resistance, reactance, and susceptance)</li> <li>• Capacitance or charging current.</li> <li>• Short-circuit current capability.</li> </ul> <p style="margin-left: 20px;">vii. Include station power for facility and all applicable details.</p> <p style="margin-left: 20px;">viii. All applicable notes pertaining to the design and operation of the facility.</p> <p>b. The Protective relay list &amp; trip schedule should list the protected equipment; the relay description, type, style number, quantity, ANSI Device No., and range; and the breaker(s)/switching device(s) tripped, for both the generator protection and the interconnection facilities protection.</p> <p>c. Please provide both a paper and an electronic version (e.g. dgn, dxf, or pdf) of the single-line diagram(s) and the protective relay list &amp; trip schedule.</p> <p>d. Single-line diagrams should be provided for both the generation plant and the interconnection substation.</p>	

**Project Interconnection - Data Request**

**FOR STORAGE**

**PROJECT:** \_\_\_\_\_

**DATE:** \_\_\_\_\_

**(Nonexclusive Preliminary List)**

**\*\*\*ALL ITEMS ARE REQUIRED AND ALL RESPONSES MUST BE FILLED UNLESS NOT APPLICABLE.\*\*\***

		Response
4)	<b>For the Inverter Based Generating Facility, please provide the following data:</b>	
	a. Inverter manufacturer, Type, Size, Impedances. Attach copy of inverter data sheet.	
	b. Power Factor Range Capability	
	c. Inverter Reactive Power Capability Curve	
	d. Auxiliary loads (P, Q, Power Factor)	
	e. Inverter's Internal Isolation Transformer Grounding Method, if used (i.e. effectively grounded, resonant grounded, low inductance grounded, high-resistance grounded, low-resistance grounded, ungrounded). If the transformer is not solidly grounded, provide the impedance value for the grounding neutral and the impedance for the isolation transformer.	
	f. Diagram for Inverter's internal isolation transformer	
	g. Switching and service restoration practice	
	h. Protection data (voltage ride-through and trip settings, frequency ride-through and trip settings etc.). Include setpoint and clearing time ranges for voltage and frequency settings.	
	i. Description of harmonic spectrum of inverter injection (order, magnitude)	
5)	<b>Energy Storage System</b>	
	a. Operation characteristics	
	b. Voltage level	
	c. Capacity (how long and how much can the battery support)	
	d. Deployment strategy/schedule	
	e. Energy storage system data sheet	
6)	<b>For the plant's collector system, please provide the following, as applicable:</b>	
	a. Conductor data such as size, insulation, etc.	
	b. Continuous and emergency current ratings.	
	c. Voltage rating (nominal and maximum kV).	
	d. BIL rating.	
	e. Positive, negative, and zero-sequence impedances (resistance, reactance, and susceptance).	
	f. Capacitance or charging current.	
	g. Short-circuit current capability.	

**Project Interconnection - Data Request**

**FOR STORAGE**

**PROJECT:** \_\_\_\_\_

**DATE:** \_\_\_\_\_

**(Nonexclusive Preliminary List)**

**\*\*\*ALL ITEMS ARE REQUIRED AND ALL RESPONSES MUST BE FILLED UNLESS NOT APPLICABLE.\*\*\***

		Response
7)	<p><b>Please provide the following software models that accurately represent the Facility:</b>            (For model requirements, refer to the HECO Facility Technical Model Requirements and Review Process and PSCAD Model Requirements Rev.9)</p> <p>a. Validated PSS/E load flow model up to the point of interconnection. The PSS/E model shall include the main transformer, collection system, generator step-up transformers, inverter systems, and any other components including capacitor banks, energy storage systems, DVAR, etc. An equivalent representation of the collection system, generator step-up transformers, and inverter systems is acceptable. Documentation on the model shall be provided.</p> <p>b. Validated PSS/E dynamic model for the inverter; and other components including energy storage system, DVAR, etc. if applicable. The inverter model shall include the generator/converter, electrical controls, plant-level controller, and protection relays. Generic and Detailed models shall be provided. Documentation on the model(s) shall be provided, including the PSS/E dyre file with model parameters.</p> <p>i. Generic models shall parameterize models available within the PSS/E standard model library.</p> <p>ii. Detailed models shall be supplied by the vendor/manufacturer as user-written models. The uncompiled source code for the user-written model shall be provided to ensure compatibility with future versions of PSS/E. In lieu of the uncompiled source code, a compiled object file and applicable library files shall be provided in PSS/E versions 33 AND 34 format. Updates of the object file compatible with future PSS/E versions must be provided as requested for the life of the project as written in the power purchase agreement. Documentation shall include the characteristics of the model, including block diagrams, values, names for all model parameters, and a list of all state variables.</p> <p>c. Validated PSCAD model of the inverter; and other components including energy storage system, DVAR, auxiliary plant controllers, etc. if applicable. Documentation on the model(s) shall be provided. Refer to PSCAD Model Requirements Memo for model requirements.</p> <p>d. Overlaid plots validating the performance of the three dynamic models for a three-phase fault. Plots shall include voltage, real and reactive power, real and reactive current.</p> <p>e. Validated Aspen Oneliner short circuit model that accurately represents the facility (including energy storage system if applicable), and is valid for all faults conditions anywhere on the Utility system. Documentation on the model(s) shall be provided. (OTHERWISE SEE ADDITIONAL TABS FOR REQUIRED INFORMATION TO MODEL INVERTER AS A GENERATOR OR A VOLTAGE CONTROLLED CURRENT SOURCE)</p>	
8)	<p><b>For the main transformer and generator step-up transformers, please provide:</b></p> <p>a. Transformer voltage and MVA ratings, and available taps. Attach copy of transformer test report or data sheet</p> <p>b. The tap settings used.</p> <p>c. The LTC Control Scheme.</p> <p>d. Transformer winding connections and grounding used. If the transformer is not solidly grounded, provide the impedance value for the grounding method.</p> <p>e. Positive, negative, and zero sequence impedance values.</p>	
9)	<p><b>For the circuit breakers and fault-clearing switching devices, including the generator breakers, please provide:</b></p> <p>a. The voltage, continuous current and interrupting capability ratings.</p> <p>b. The trip speed (time to open).</p>	

**Project Interconnection - Data Request**

FOR STORAGE

PROJECT: \_\_\_\_\_

DATE: \_\_\_\_\_

(Nonexclusive Preliminary List)

\*\*\*ALL ITEMS ARE REQUIRED AND ALL RESPONSES MUST BE FILLED UNLESS NOT APPLICABLE.\*\*\*

		Response
10)	<b>For the power fuses, please provide:</b>	
	a. The manufacturer, type, size, and interrupting capability.	
	b. The minimum melt and total clearing curves.	
11)	<b>For the protective relaying, please provide:</b>	
	a. Data for the CTs used with the relaying including the manufacturer, type of CT, accuracy class, and thermal rating factor.	
	b. Data for the PTs used with the relaying including the manufacturer, type of PT, voltage ratings, and quantity.	



Instructions:

Please fill in the data in the green blanks below

(Note: This does not include the internal isolation transformer, if used)

[1] Maximum rated output power =  kVA

[2] Impedances in **Per Unit** based on kVA from [1]

	R	X
Subtransient =	<input type="text"/>	<input type="text"/>
Transient =	<input type="text"/>	<input type="text"/>
Synchronous =	<input type="text"/>	<input type="text"/>
Negative Sequence =	<input type="text"/>	<input type="text"/>
Zero Sequence =	<input type="text"/>	<input type="text"/>

[3] Neutral impedance (if any) in actual **Ohms**:

R	X
<input type="text"/>	<input type="text"/>

NOTE: These parameters should reflect the inverter response for all types of faults at any point on the electrical system to which the inverter is connected. This includes faults at the inverter output terminals, and also on the 138 kV transmission system. If the stated parameters do not cover this range, please state the adjustments needed to these parameters to accurately represent the inverter response across this range.

These parameters will be used to model the inverter in the Aspen Oneliner program as shown in the sample dialog box below:

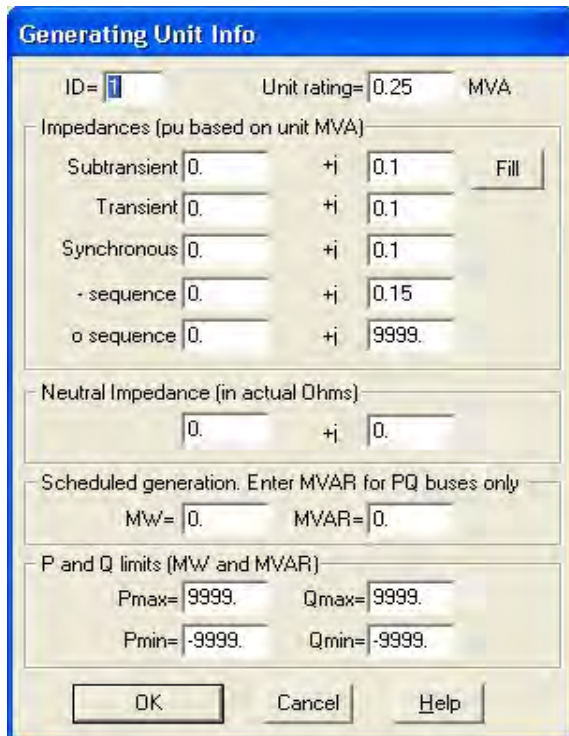

Instructions:

Please fill in the data in the green blanks below

- [1] Internal open circuit voltage  
Magnitude =  Per Unit  
Angle =  Degrees
- [2] AC Output Current Limit =  Amps

NOTE: These parameters should reflect the inverter response for all types of faults at any point on the electrical system to which the inverter is connected. This includes faults at the inverter output terminals, and also on the 138 kV transmission system. If the stated parameters do not cover this range, please state the adjustments needed to these parameters to accurately represent the inverter response across this range.

These parameters will be used to model the inverter in the Aspen Oneliner program as shown in the sample dialog box below:

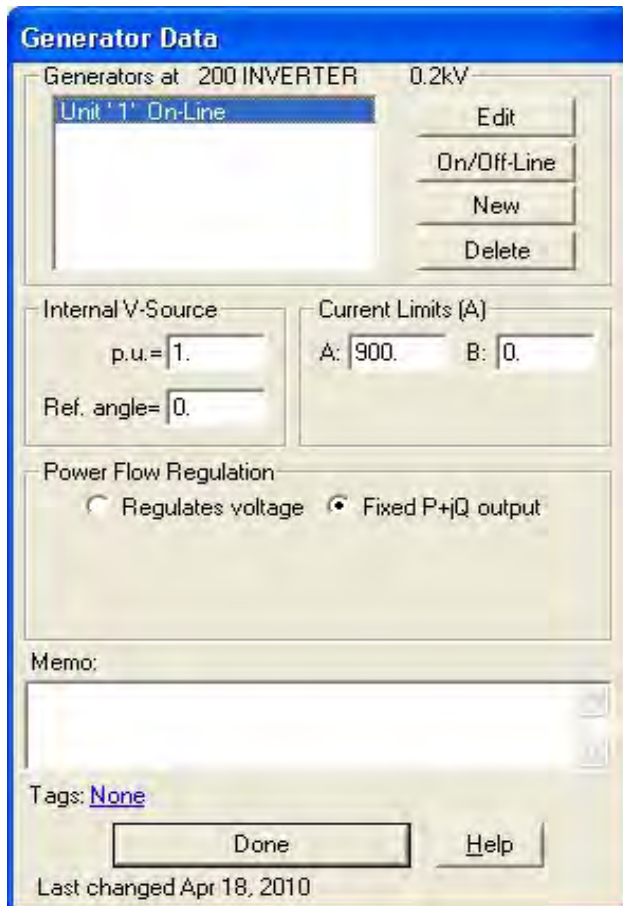

Instructions:

Please fill in the data in the green blanks below

- [1] Inverter MVA Rating:  MVA
- [2] Voltage-Current Characteristics:
- | Voltage PU           | Current (A)          | PF Angle (deg)       |
|----------------------|----------------------|----------------------|
| <input type="text"/> | <input type="text"/> | <input type="text"/> |
| <input type="text"/> | <input type="text"/> | <input type="text"/> |
| <input type="text"/> | <input type="text"/> | <input type="text"/> |
| <input type="text"/> | <input type="text"/> | <input type="text"/> |
- [3] Location of Voltage Measurement:  Device Terminal OR  
 Network side of Transformer
- [4] Maximum Voltage:  Times prefault value
- [5] Minimum Voltage  Per Unit

These parameters will be used to model the inverter in the Aspen Oneliner program as shown in the sample dialog box below:

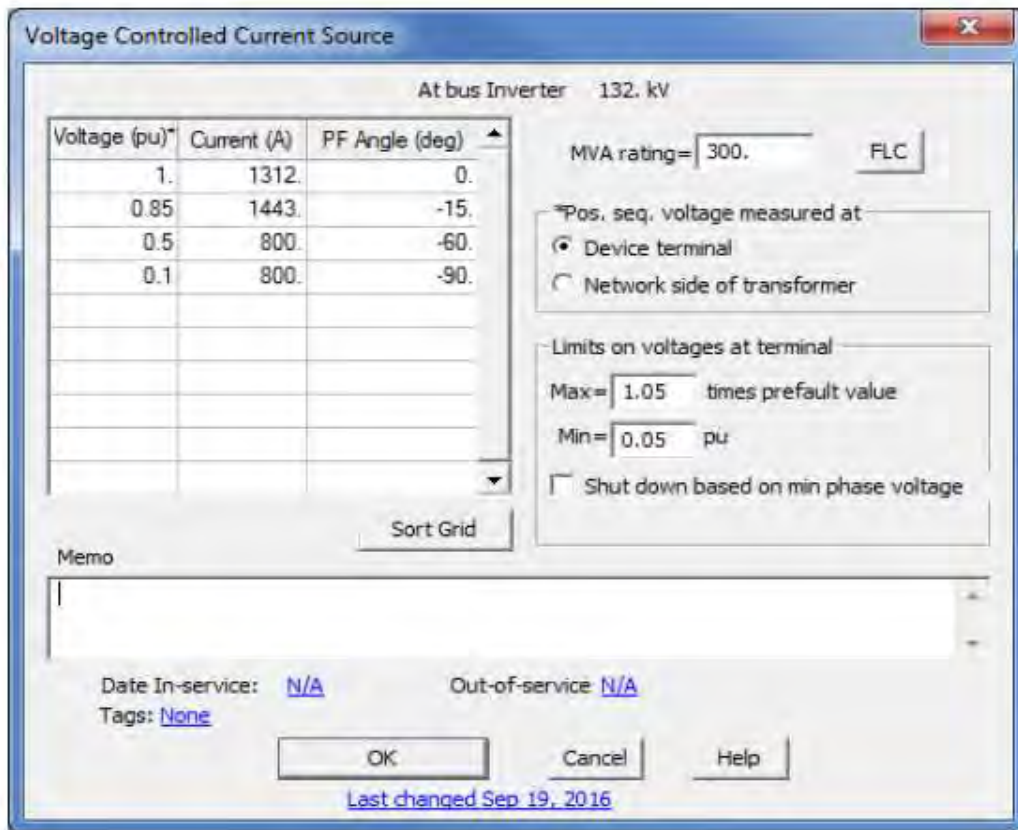

Instructions:

Please fill in the data in the green blanks below

(Note: This is not required if an internal isolation transformer is not used)

[1] Transformer rated power =  kVA

[2] Winding Configuration  
 Inverter Side =  Delta/Wye  
 Customer Side =  Delta/Wye

[2] Impedances in **Per Unit** based on kVA  
 Positive Sequence =  R  X  
 Zero Sequence =

[3] Neutral impedance (if any) in actual **Ohms**:  
 R  X

These parameters will be used to model the inverter in the Aspen Oneliner program as shown in the sample dialog box below:

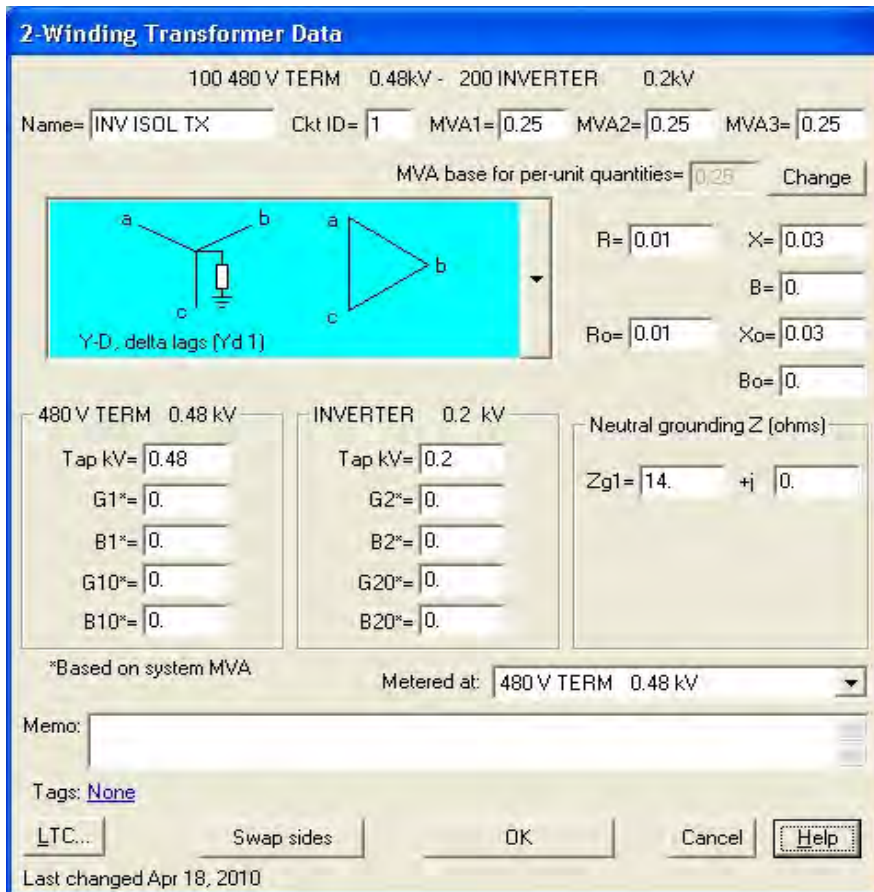



# **HAWAIIAN ELECTRIC FACILITY TECHNICAL MODEL REQUIREMENTS AND REVIEW PROCESS**

August 23, 2021



## Table of Contents

HAWAIIAN ELECTRIC FACILITY TECHNICAL MODEL REQUIREMENTS AND REVIEW PROCESS .....	0
1 INTRODUCTION .....	1
2 FACILITY TECHNICAL MODEL REQUIREMENTS.....	2
2.1 Overview of Submission .....	2
2.2 Background Functional Description of GFM and GFL .....	3
2.3 General requirements for all technical models.....	3
2.4 Requirements for generation facility PSCAD model .....	4
2.5 Requirements for generation facility PSS/E power flow model.....	4
2.6 Requirements for generation facility user defined PSS/E dynamic model.....	5
2.7 Requirements for generation facility generic PSS/E dynamic model .....	6
2.8 Requirements for generation facility ASPEN model .....	6
3 GENERATION FACILITY TECHNICAL MODEL REVIEW PROCESS.....	7
3.1 Model review in PSCAD .....	7
3.2 Model review in PSS/E.....	7
3.3 GFM Model review in PSCAD and PSS/E .....	10
4 TYPICAL ISSUES IDENTIFIED FROM THE FACILITY MODEL SUBMITTALS DURING THE PAST RFP PROCESS.....	13
REFERENCE .....	14
APPENDIX A: SAMPLE OVERLAID GENERATION FACILITY TECHNICAL MODEL OUTPUT PLOT FOR THREE-PHASE FAULT.....	15
APPENDIX B: SAMPLE TEST SYSTEM TOPOLOGYINFORMATION .....	17



# 1 INTRODUCTION

---

This document summarizes requirements of generation facility technical model submittals for request for proposals for variable renewable dispatchable generation and energy storage and describes the review process for model submittals. The requirements and examples provided are based on the Company's current information as of the date of this document and are subject to change.



## 2 FACILITY TECHNICAL MODEL REQUIREMENTS

---

To fully investigate impacts of the proposed generation facility on Hawaiian Electric's system and correctly identify any mitigation measures, the proposed generation facility technical model, along with related technical documents, will need to be submitted for review prior to System Impact Study (SIS).

### 2.1 Overview of Submission

For all generation facility types, the technical model submittal shall include:

1. PSCAD model<sup>1</sup>
2. PSS/E power flow model
3. Standard Library PSS/E dynamic model
4. User defined PSS/E dynamic model, and
5. ASPEN Oneliner model

For generation facilities categorized as inverter-based resources, both Grid Following (GFL) and Grid Forming (GFM) Mode capability may be required from the project. In this case, for each project, two sets of models shall be submitted: one with the project in GFL mode, and the other with the project in GFM mode. The GFL mode technical model submittal shall follow the list above. The GFM mode technical model submittal shall include:

6. GFM PSCAD model
7. GFM User defined PSS/E dynamic model
8. GFM ASPEN Oneliner model if it differs from the GFL model

Subject to Hawaiian Electric's approval, if the manufacturer can certify current standard library dynamic models accurately represent their equipment, standard library dynamic models may be provided and used in lieu of user defined dynamic models. As an example, if the generation facility is a traditional synchronous machine, of which the technology is standardized and widely understood across the industry, it can generally be accurately represented with current standard library dynamic models and thus a user defined dynamic model will not be required.

Along with the technical models, the following documents shall also be submitted for review:

9. User manual for all technical models, including a description of GFM functionality if GFM is used.
10. Generation facility one-line diagram
11. Generation unit manufacturer datasheet(s)
12. Generation unit reactive power capability curve(s)
13. Overlaid generation facility technical model output data for three-phase fault and single-phase fault. (Sample plots are shown in Appendix A)

---

<sup>1</sup> For specific PSCAD model requirements, refer to <http://www.electranix.com/wp-content/uploads/2021/02/Requirements-Rev.-10-Feb-3-2021.pdf>





## 2.2 Background Functional Description of GFM and GFL

Grid Following and Grid Forming are terms with some ambiguity in current industrial usage. For the purpose of this document, the following definitions are provided as high level functional descriptions. For more detailed descriptions of what is required for each of these control modes, it is recommended to carefully review descriptions of the functional tests which will be performed.

### Grid Following (GFL) Mode:

Grid Following is defined as follows: An inverter-based resource that relies on fast synchronization with the external grid in order to tightly control the inverter's active and reactive current outputs. If these inverters are unable to remain synchronized effectively during grid events or under challenging network conditions, they are unable to maintain controlled, stable output. Advanced versions of these devices (Advanced Inverters) can provide grid supporting functions such as: voltage and frequency ride-through, volt-VAR, frequency-Watt, volt-watt, etc.; when they are able to remain synchronized.

### Grid Forming (GFM) Mode:

Grid Forming is defined as follows: GFM controls set an internal voltage waveform reference such that an inverter with the GFM control shall be able to synchronize with the grid and regulate active and reactive power generation appropriately, regardless of the grid's strength, or operate independently of other generation. An inverter with GFM control shall immediately respond to grid disturbances to support stability of the grid and maintain its own control stability during the system disturbances.

## 2.3 General requirements for all technical models

All technical models need to represent the whole generation facility, not only a generation unit such as one inverter or as separate files representing pieces of the facility. At minimum, the following equipment shall be included in the single whole generation facility model:

1. Generation unit, such as inverter with DC side model, or a rotating machine with model of exciter and governor.
2. Step up transformer, with correct impedances and winding configuration
3. Collection system, aggregated per WECC guidance<sup>2</sup>
4. Main interconnection transformer, or GSU, with its tap changer if applicable, including correct impedances and winding configuration
5. Grounding transformer if used
6. VAR compensation device, such as cap bank or STATCOM, if applicable
7. Power plant controller (not for ASPEN model)
8. Documentation
9. Gen-tie line (as applicable)

---

<sup>2</sup> <https://www.wecc.org/Reliability/WECCWindPlantPowerFlowModelingGuide.pdf>



Equivalent or aggregated representations of the collection system, generator step-up transformers, and inverter systems are acceptable if it can accurately represent the generation facility and its response characteristics.

## 2.4 Requirements for generation facility PSCAD model

In addition to the general requirements mentioned above, the generation facility PSCAD model shall satisfy requirements as described in the latest version of the PSCAD Model Requirements document from Electronix Corporation (<https://www.electronix.com/the-electranix-library/>) and provided by Hawaiian Electric.

The control implementation (e.g., turbine controls, inverter controls, protection and measurement algorithms, and plant-level controller) in the generation facility PSCAD model shall implement the actual control code from the equipment. The PSCAD model shall provide output channel of voltage and frequency measured by the Facility and used for Facility's control and protection.

For the generation facility with grid-forming control, a document which describes the general mechanism and implementation of the grid-forming control is required.

## 2.5 Requirements for generation facility PSS/E power flow model

The generation facility PSS/E power flow model shall be provided for PSS/E versions 33, 34 and 35. Besides the general requirements mentioned above, the following modeling data shall be provided in the model:

1. Conductor
  - a. Impedance, both positive sequence and zero sequence
  - b. Rating: Rating A – normal rating, and Rating B – emergency rating
2. Transformer
  - a. Nominal voltages of windings
  - b. Impedance data: specified R and X
  - c. Tap ratios
  - d. Min and Max tap position limits
  - e. Number of tap positions
  - f. Regulated bus
  - g. Ratings: Rate A – normal rating; Rate B – emergency rating
  - h. Winding configuration
3. Reactive power compensation, if applicable
  - a. Fixed Shunts: G-Shunt (MW), B-Shunt (MVar)
  - b. Switched Shunts: Voltage limits (V<sub>hi</sub> and V<sub>low</sub>), mode of operation (fixed, discrete, continuous), regulated bus, Binit (MVar), steps and step size (MVar)
4. Generation unit
  - a. P<sub>max</sub>
  - b. P<sub>min</sub>
  - c. Q<sub>max</sub>
  - d. Q<sub>min</sub>
  - e. Name plate MVA



- f. Transformer data: R Tran, X Tran, and Gentap.
- g. Voltage control point

## 2.6 Requirements for generation facility user defined PSS/E dynamic model

The submitted user defined PSS/E dynamic model shall meet the following requirements:

1. The generation facility PSS/E dynamic model shall be provided for PSS/E versions 33, 34 and 35.
2. The project shall be modeled at full output per the project's Interconnection Request.
3. User defined dynamic models must accurately model all the relevant control modes and characteristics of the equipment, such as:
  - a. All available voltage/reactive power control modes
  - b. Frequency/governor response control modes
  - c. Voltage and frequency ride-through characteristics
  - d. Power plant controller or group supervisory functionality
  - e. Appropriate aggregate modeling capability
  - f. Charging mode if applicable (e.g., for a battery energy storage device)
4. Dynamic model source code (.flx, .for, .f90, .f, etc.), or dynamic linked library (.dll), and PSS/E dyn file shall be provided.
5. User defined dynamic model plant-specific settings shall comply with requirements listed in the Power Purchase Agreement, including ride-through thresholds and other specified control settings if applicable.
6. User defined dynamic models related to individual units shall be editable in the PSS/E graphic user interface. All model parameters (CONS, ICONS, and VARS) shall be accessible and shall match the description in the model's accompanying documentation.
7. User defined dynamic models shall have all their data reportable in the "DOCU" listing of dynamics model data, including the range of CONS, ICONS, and VARS numbers. Models that apply to multiple elements (e.g., park controllers) shall also be fully formatted and reportable in DOCU.
8. User defined dynamic models shall be capable of correctly initializing and run through the simulation throughout the range of expected steady state starting conditions without additional manual adjustments.
9. User defined dynamic models shall be capable of allowing all documented (in the model documentation) modes of operation without error.
10. User defined dynamic model shall be accompanied by the following documentation:
  - a. A user's guide for each model
  - b. Appropriate procedures and considerations for using the model in dynamic simulations
  - c. Technical description of characteristics of the model
  - d. Block diagram for the model, including overall modular structure and block diagrams of any sub-modules
  - e. List of plant-specific settings, which may include:
    - i. Ride-through thresholds and parameters
    - ii. Plant-level voltage controller settings
    - iii. Power ramp rate settings
    - iv. ICON flag parameters for specific control modes



- v. Deadbands
- vi. Initial State of Charge (SOC)
- f. Values, names and detailed explanation for all model parameters
- g. List of all state variables, including expected ranges of values for each variable

## 2.7 Requirements for generation facility generic PSS/E dynamic model

The submitted generic PSS/E dynamic model should meet the following requirements:

1. All generic PSS/E dynamic models must be standard library models in PSS/E.
2. The generation facility PSS/E dynamic model shall be provided for PSS/E versions 33, 34 and 35.
3. The project shall be modeled at full output per the project's Interconnection Request.
4. Generic dynamic models must accurately model all the relevant control modes and characteristics of the equipment, such as:
  - a. All available voltage/reactive power control modes
  - b. Frequency/governor response control modes
  - c. Voltage and frequency ride-through characteristics
  - d. Power plant controller or group supervisory functionality
  - e. Appropriate aggregate modeling capability
  - f. Charging mode if applicable (e.g., for a battery energy storage device)
5. PSS/E dyr file shall be provided.
6. Generic dynamic models' plant-specific settings should comply with requirements listed in the Power Purchase Agreement, including ride-through thresholds and other specified control settings if applicable.
7. Generic dynamic models shall be capable of correctly initializing and run through the simulation throughout the range of expected steady state starting conditions without additional manual adjustments.
8. Generic dynamic models shall be accompanied by the following documentation:
  - a. A user's guide for each model
  - b. Appropriate procedures and considerations for using the model in dynamic simulations
  - c. Technical description of characteristics of the model
  - d. List of plant-specific settings, which may include:
    - i. Ride-through thresholds and parameters
    - ii. Plant-level voltage controller settings
    - iii. Power ramp rate settings
    - iv. ICON flag parameters for specific control modes
    - v. Deadbands
    - vi. Initial State of Charge (SOC)

## 2.8 Requirements for generation facility ASPEN model

Besides the general requirements, validation results of three-phase fault current from the generation unit represented in the generation facility ASPEN Oneliner model shall be provided.



## 3 GENERATION FACILITY TECHNICAL MODEL REVIEW PROCESS

---

To review the generation facility technical model, the following procedures are performed in the PSCAD and PSS/E environment. A review of the results will be documented and provided to the Customer for confirmation of model acceptance or further model updates.

### 3.1 Model review in PSCAD

- 1) Review model data against latest version of the PSCAD Model Requirements document from Electronix Corporation (<https://www.electronix.com/the-electranix-library/>) provided by Hawaiian Electric. In this step, it will be determined whether the model is complete, generation facility settings are according to the Power Purchase Agreement, and if the model can be compiled and run without any error. Checklists are provided in this document which are useful for both preparing a model submission, and for reviewing a model submission.
- 2) Initialization test:  
In this step, the generation facility PSCAD model will be determined whether the model initialization is acceptable. Hawaiian Electric requires that:
  - 1) The PSCAD model shall initialize as quickly as possible (e.g. <1-3 seconds) to user defined terminal conditions.
  - 2) Project PSCAD model shall initialize properly and that the same power flow and voltage conditions shall be observed between the PSCAD and PSS/E models after initialization.
- 3) Voltage and frequency ride-through tests:  
In this step, the generation facility PSCAD model ride-through performance will be reviewed by performing voltage and frequency ride-through simulations in PSCAD. The review will focus on the generation facility model dynamic response during and after ride-through and generation facility trip time.
- 4) Fault simulation tests:  
Two types of fault tested at the Point of Interconnection bus of the generation facility will be performed in this step.
  - i) 3-phase to ground fault with 6-cycle clearing time (same as the PSS/E ring down model test described in the following section).
  - ii) 1-phase to ground fault simulation with 6-cycle clearing time.

In this test, fault current contribution from the generation facility observed in the simulation will be reviewed by comparing it against the generation facility technical document.

### 3.2 Model review in PSS/E

- 1) **Model data review:**  
Review model data based on the requirements for PSS/E power flow and dynamic model provided by Hawaiian Electric. In this step, the review determines whether the model is complete, generation facility settings is according to the PPA, and model can be compiled and run without any error.



a. Steady State Model Data Review

Review the ratings and impedances of all equipment in the ASPEN Oneliner, PSS/E and PSCAD models and check for discrepancies.

Table 1. Steady State Model Data Review

Equipment	Comments
Gen-Tie Line	PSS/E, PSCAD and ASPEN models should match
Main Power Transformer Impedance	PSS/E, PSCAD and ASPEN models should match
Main Power Transformer Impedance	PSCAD and ASPEN models should match
PV Collector System Data	PSS/E, PSCAD and ASPEN models should match
BESS Collector System Data	PSS/E, PSCAD and ASPEN models should match
Inverter Pad Mount Transformer Impedance	PSS/E, PSCAD and ASPEN models should match
Inverter Pad Mount Transformer Configuration	PSCAD and ASPEN models should match
Inverter Power Flow Data	PSS/E and PSCAD models should match
Voltage Control Point	PSS/E and PSCAD models should match

b. Dynamic Data Review

Compare the various dynamic model parameters and note any discrepancies.

Table 2. Dynamic Model Data Review

Equipment	Comments
Power Plant Controller (PPC)	Review number of PPCs. Should represent actual setup of plant when in service.
Control Flags	PSS/E and PSCAD control flags should match.
Control Bus/Point of Measurement	Control buses should match in PSS/E and PSCAD models.
Frequency Control Dead Band	The frequency thresholds for primary and secondary control should match in the PSCAD and PSS/E models.
Initial State of Charge (SOC)	Make sure the initial state of charge is set up correctly to prevent initialization issues.
Voltage and Frequency Ride Through	The voltage and frequency ride through settings should match in the PSS/E user-written, PSS/E generic and PSCAD models.
P/Q priority data	The P/Q priority flags should match in the PSS/E user-written, PSS/E generic and PSCAD models

**2) Flat start test:**

PSS/E models shall initialize correctly and be capable of successful “flat start” testing using the 20 Second No-Fault simulation: This test consists of a 20 second simulation with no disturbance applied. Flat run in a two-machine system (one machine is a synchronous machine, e.g., GENCLS model, and the other machine is a project’s model.)



**3) Ring down test:**

PSS/E models shall initialize correctly and be capable of successful “ring down” testing using the 60 Second Disturbance Simulation: This test consists of the application of a 3-phase fault for 6 cycles at POI bus, followed by removal of the fault without any lines being tripped. The simulation is run for 60 seconds to allow the dynamics to settle.

**4) Voltage and frequency ride-through tests:**

In this step, the generation facility PSS/E model ride-through performance will be reviewed by performing voltage and frequency ride-through simulation in PSS/E. The review will focus on the generation facility model dynamic response during and after ride-through and generation facility trip time. **The procedures and values listed in this section are illustrative and serve as examples only; ride-through durations shall be tested against the minimum requirements outlined in the respective PPA.**

a. Voltage Ride-Through

- In these simulations, the POI voltage is varied to test the facility’s ride-through capabilities and responses to POI voltage excursions. In the PSS/E simulations, two sets of tests are performed: one for testing the ride-through capabilities and the other for testing the responses to voltage excursions. These two sets of tests are similar, except that the grid equivalent representation is different. For the ride-through tests, the grid equivalent is represented by a generator with a very large MVA, which connects to the POI bus directly.
  - o *As an example, for the voltage excursion response tests, the grid equivalent may be represented by a 200 MVA generator (actual MVA rating dependent on POI, please consult the Company for representative values) which connects to the POI through a branch with a reactance of 0.1 p.u.*
- In the PSCAD simulations, the focus is on testing the facility’s reactive power responses to POI voltage excursions, and not on testing the voltage ride-through capability.

Table 3 shows the voltage excursions that will be simulated in the PSCAD tests.

Table 3. Voltage	Duration (s)
1.20	0.8
1.10	2.0
0.88	2.0
0.70	2.0

Each of the above discussed tests were performed for the following three generation dispatches:

- i. PV output only: In this dispatch, the PV unit is at maximum output and the BESS unit is online at 0 MW.
- ii. BESS output only: In this dispatch, the BESS unit is discharging at maximum output and the PV unit is online at 0 MW.



- iii. PV charging BESS: In this dispatch, the PV unit is at its maximum output and is charging the BESS at its minimum level.
  
- b. Frequency Ride-Through
  - In these simulations, the system frequency is varied to test the facility's responses to grid's frequency excursions. In the PSS/E tests, high and low frequency excursions are simulated to mimic the frequency ride through thresholds specified in the PPA and the response of the facility is observed. Both the frequency ride-through capability of the facility and its active power response to frequency excursions are tested in the PSS/E simulations.
  - In the PSCAD simulations, the focus is on testing the facility's active power responses to frequency excursions, and not on testing the frequency ride-through capability. Table 4 and Table 5 show example frequency excursions that are simulated in the PSCAD tests.

Table 4. Frequency Excursions for PSCAD High Frequency Response Test

Frequency Level (Hz)	Duration (s)
60.1	2.0
63.0	2.0

Table 5. Frequency Excursions for PSCAD Low Frequency Response Test

Frequency Level (Hz)	Duration (s)
59.9	2.0
56.0	2.0

## 5) Expected Model Performance

- a. Matching steady-state model parameters between the PSS/E user-written, generic models and the PSCAD model.
- b. Matching control options between the three types of models.
- c. Matching voltage and frequency ride-through parameters between the three types of models. The settings should meet the ride-through requirements specified in the PPA.
- d. Flat run results do not show any movement for any of the three models.
- e. Ring-down simulation results show stable and proper responses, and the responses from the three models should show reasonable matches.
- f. Ride-through simulation results should show stable and proper responses, and the responses should show reasonable matches. The ride through performance should meet the PPA requirements.

## 3.3 GFM Model review in PSCAD and PSS/E

The tests described below will be performed in addition to the GFL model tests described in section 3.1.





**Test notes:**

- Applicable for generation facilities which have grid-forming control capability
- Assumption is that BESS has available energy and is dispatched suitably for the tests
- Each test will be repeated with three initial operating conditions, as applicable (PV output only, BESS output only, PV charging BESS)
- The project should be configured to be in GFM mode throughout these tests

**1) Able to black start and operate in an electrical island (applicable if project is providing black start capability):**

Test sequence: energize main power transformer from project side, then connect project to a load, then apply a bus fault at the POI, then remove the fault. Expected results: voltage and frequency should be stable and settle back to close to their nominal values after the disturbances.

**2) Loss of the last synchronous machine:**

Test system will be a three-machine system including: a synchronous machine modeled by GENROU with a simple excitation system model (e.g., SCRX) and a simple governor model (e.g., TGOV1), a load with both real and reactive components, and duplicates of a project's model. Duplicates of a project's model are utilized here to check if the project is able to share real and reactive power properly with other generators. Test event: trip the synchronous generator. Expected results: voltage and frequency should be stable and settle back to close to their nominal values after the disturbance, within the tolerance of the droop and deadband settings.

**3) Weak grid operation:**

Test system is the project plant model and an equivalent voltage source behind an impedance connected at the POI. The test will be to gradually decrease MVA of the equivalent voltage source within a range and check if the project's model is able to work with the studied MVA range.

**4) Able to operate in harmony with other converter resources and synchronous machines:**

Test system is the three-machine system including: a synchronous machine modeled by GENROU with a simple excitation system model and a simple governor model, a load with both real and reactive components, and duplicates of a project's model. Simulation tests to be performed may include load step up/down, ringdown, voltage ride through and frequency ride-through tests. Expected results: voltage and frequency should be stable and settle back to close to their nominal values after the disturbances.

Particularly related to frequency control characteristics, we will test for configurable frequency droop control and configurable deadband characteristics. The frequency deadband should be settable in the range from +/- 0.01 Hz to +/- 1.0 Hz and the frequency droop shall be settable in the range of 0.1% to 10% with a typical value of 4%. A sample characteristic of frequency droop control with deadband is shown in Figure 1.

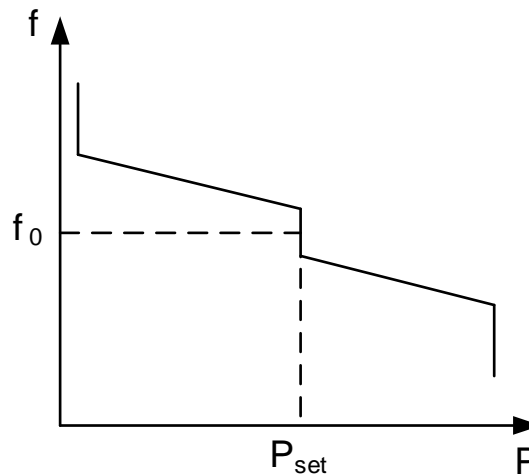

Figure 1 – Frequency Droop Control Characteristic with Deadband

**5) Switching from an electrical island to a grid-connected configuration while in GFM mode (dependent on specific project technology and controls)**

Test system is the two-machine system. Test sequence: energize main power transformer from project side, then connect project to a load (if project model does not have black-start capability, the plant will be initialized using a voltage source which will be switched out after initialization). At this point, the project will be operating in an island. Then switch in the synchronous generator. Expected results: voltage and frequency should be stable and settle back to close to their nominal values after the disturbances.

**Tests to be performed for PSS/E models only**

**6) Reduction in frequency deviation in GFM mode**

Test system will be a relevant HECO island system model. Test event is loss of a large generator. Project model will be in GFL mode and GFM mode. Result: less degree of frequency deviation is expected when project is in GFM mode than when the project is in GFL mode.

**ASPEN Model Check**

**7) A review of the ASPEN Oneliner generation models will be performed.**

As mentioned above, two models are expected for each project: one model for GFL mode, and the other for GFM mode. Documentation associated with the models should be provided. The model review will check if the components of a project are modeled properly, such as transformers, equivalent collector system, equivalent generator, etc., and that the model data are consistent to the PSS/E and PSCAD model data. A fault simulation test will also be performed in a two-machine system. Total current at the fault location and contribution from each machine will be reviewed and documented.



## 4 TYPICAL ISSUES IDENTIFIED FROM THE FACILITY MODEL SUBMITTALS DURING THE PAST RFP PROCESS

---

### 1. Missing documentation

Only generation technical facility models are submitted, but no model user manual or any other documentation. Without model documentation, it is very difficult to know the correct procedures of using the technical models and identifying issues during the review.

### 2. Model incompleteness

Often, the model of a single generation unit, such as an inverter, is submitted instead of model of the whole generation facility, which is insufficient. The model of the generation facility should include models for all equipment listed in the section of “General requirements for all technical models”.

### 3. Settings in the model

Type issues in this category are:

- The PSCAD (GFL and/or GFM) and PSS/E model ride-through settings are not consistent with the minimum settings defined in the Power Purchase Agreement.
- Generation MW is not set as defined.
- Model is set for 50 Hz instead of 60 Hz

### 4. Model function issues

Some models do not function as expected during different test scenarios. For example:

- Fault current contribution from the generation facility is higher than what is described in the generation facility datasheet
- Generation level is not stable with provided settings during the initialization test
- Inadequately damped oscillations observed in the ringdown test
- Ride-through performance does not reach minimum requirements defined in the Power Purchase Agreement

### 5. Power Plant Controller (PPC)

Often, the PPC control had not yet been fully considered when models are submitted, which results in improperly configured PPC controls, or model submissions missing the PPC altogether. The PPC(s) included in the facility model should include coordination functionality between the plant components, and should represent the actual planned implementation.



## REFERENCE

---

- [1] New England Iso Planning procedure – Interconnection planning procedure for generation and elective transmission upgrades
- [2] ERCOT Planning Guide, 2019
- [3] PJM MOD-032 Steady State, Dynamics, and Short Circuit Modeling Data Requirements and Reporting Procedures Document



## APPENDIX A: SAMPLE OVERLAID GENERATION FACILITY TECHNICAL MODEL OUTPUT PLOT FOR THREE-PHASE FAULT

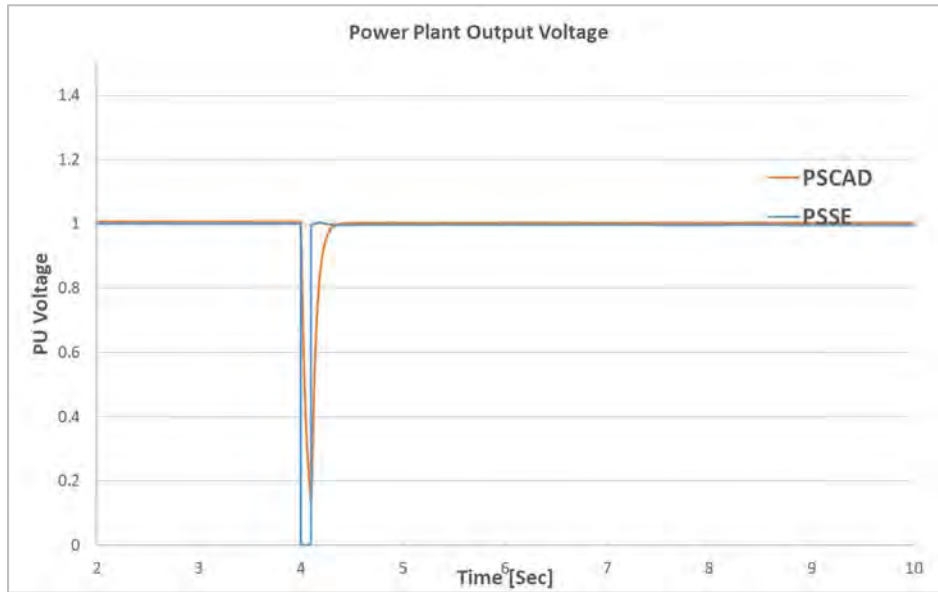

Figure 1: Overlaid plot for power plant voltage

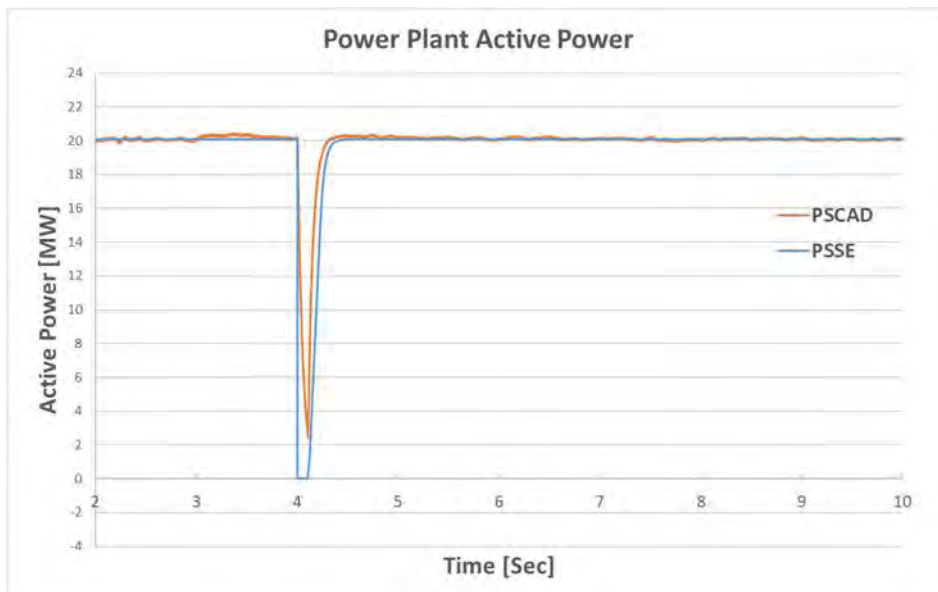

Figure 2: Overlaid plot for power plant active power generation

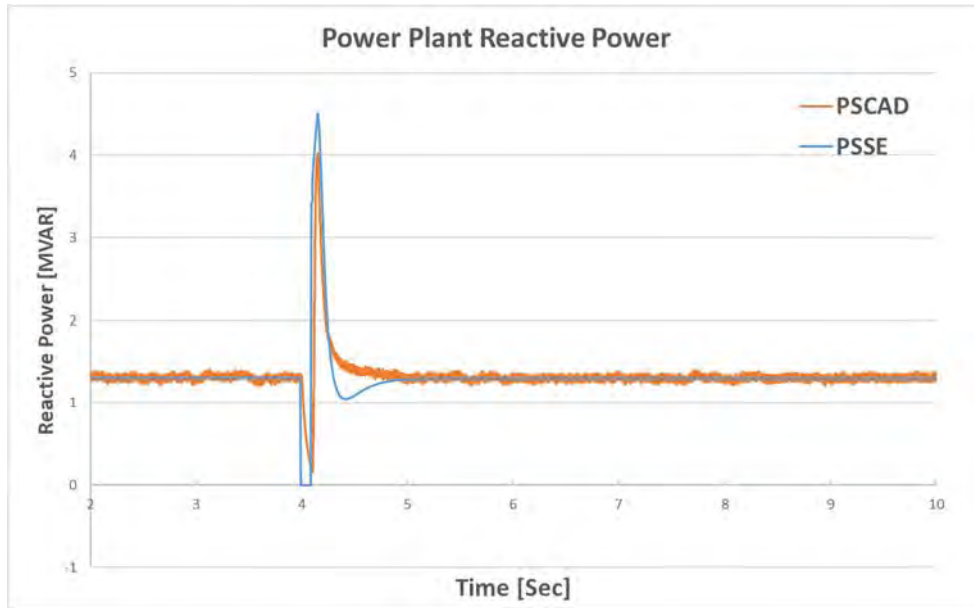

Figure 3: Overlaid plot for power plant reactive power generation



## APPENDIX B: SAMPLE TEST SYSTEM TOPOLOGY INFORMATION

On weak grids such as island systems, it is important to test the models using a representative high Thevenin equivalent impedance.

A typical topology of testing circuit which represents Hawaiian Electric system for 46 kV project is shown in Figure 4. Sample 46 kV Thevenin equivalent impedance is available upon request for model testing.

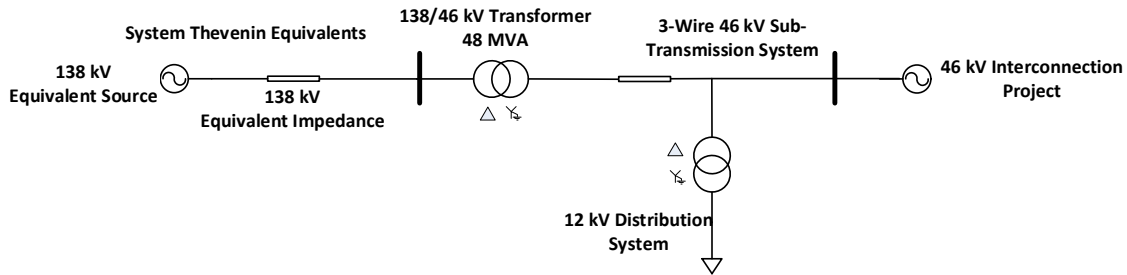

Figure 4: Testing circuit single line diagram for 46 kV project

A typical topology of testing circuit which represents Hawaiian Electric system for 138 kV project is shown in Figure 5. Sample 138 kV Thevenin equivalent impedance is available upon request for model testing.

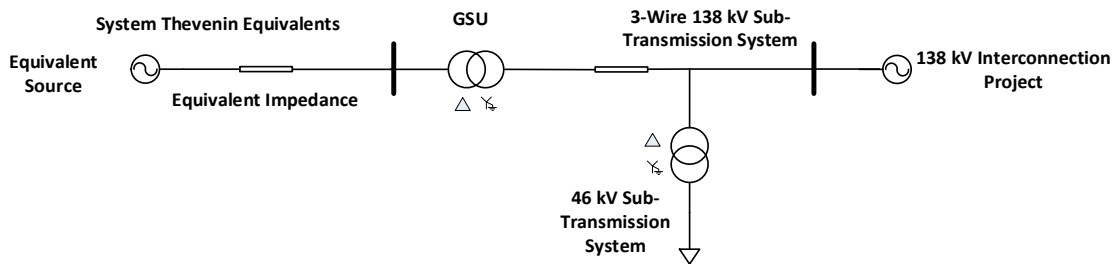

Figure 5: Testing circuit single line diagram for 138 kV project

North Kohala Model and Interconnection Requirements Study (IRS) Scope

<b>Island</b>	Hawai'i														
<b>Size</b>	Connecting to Hawi Substation Single Project														
<b>Models</b>	Grid Forming PSS®E User Defined, Grid Forming PSCAD, and Grid Forming ASPEN.  Note: Grid Following PSS®E User Defined, Grid Following PSS®E Generic, Grid Following PSCAD, and Grid Following ASPEN may potentially be required if issues with Grid Forming performance are identified.														
<b>System Impact Study Scope</b>	<table border="1"> <thead> <tr> <th style="background-color: #cccccc;">Tasks</th> </tr> </thead> <tbody> <tr> <td>(Include selected tasks in the IRS. Exclude tasks that are unselected)</td> </tr> <tr> <td><input checked="" type="checkbox"/> Interconnection One-Line, Three-Line, and Equipment List</td> </tr> <tr> <td><input checked="" type="checkbox"/> Project Data Requirements and Facility Technical Model Review</td> </tr> <tr> <td><input checked="" type="checkbox"/> Review of Existing System Performance (Base-Case)</td> </tr> <tr> <td><input checked="" type="checkbox"/> Develop Project Model (IRS Case)</td> </tr> <tr> <td><input checked="" type="checkbox"/> Steady-State Power Flows           <ul style="list-style-type: none"> <li><input checked="" type="checkbox"/> Reverse Power Flow</li> <li><input checked="" type="checkbox"/> Reactive Power Requirements</li> </ul> </td> </tr> <tr> <td><input checked="" type="checkbox"/> Protection Review</td> </tr> <tr> <td><input checked="" type="checkbox"/> Voltage Flicker</td> </tr> <tr> <td><input checked="" type="checkbox"/> Voltage Transients (In-Rush Current)</td> </tr> <tr> <td><input checked="" type="checkbox"/> System Stability           <ul style="list-style-type: none"> <li><input checked="" type="checkbox"/> PSSE Analyses</li> <li><input checked="" type="checkbox"/> PSCAD Analyses for Weak Grid Conditions</li> <li><input checked="" type="checkbox"/> Grid Forming Analyses</li> </ul> </td> </tr> <tr> <td><input checked="" type="checkbox"/> Ride-Through Requirements</td> </tr> <tr> <td><input checked="" type="checkbox"/> Unintended Islands           <ul style="list-style-type: none"> <li><input checked="" type="checkbox"/> Transient Overvoltage (TrOV)</li> <li><input checked="" type="checkbox"/> Unintended Islands Fault Overvoltage (GFOV)</li> </ul> </td> </tr> <tr> <td><input type="checkbox"/> Harmonics           <ul style="list-style-type: none"> <li><input type="checkbox"/> Harmonics Model Analysis</li> <li><input type="checkbox"/> Harmonics Monitoring Assessment</li> </ul> </td> </tr> </tbody> </table>	Tasks	(Include selected tasks in the IRS. Exclude tasks that are unselected)	<input checked="" type="checkbox"/> Interconnection One-Line, Three-Line, and Equipment List	<input checked="" type="checkbox"/> Project Data Requirements and Facility Technical Model Review	<input checked="" type="checkbox"/> Review of Existing System Performance (Base-Case)	<input checked="" type="checkbox"/> Develop Project Model (IRS Case)	<input checked="" type="checkbox"/> Steady-State Power Flows <ul style="list-style-type: none"> <li><input checked="" type="checkbox"/> Reverse Power Flow</li> <li><input checked="" type="checkbox"/> Reactive Power Requirements</li> </ul>	<input checked="" type="checkbox"/> Protection Review	<input checked="" type="checkbox"/> Voltage Flicker	<input checked="" type="checkbox"/> Voltage Transients (In-Rush Current)	<input checked="" type="checkbox"/> System Stability <ul style="list-style-type: none"> <li><input checked="" type="checkbox"/> PSSE Analyses</li> <li><input checked="" type="checkbox"/> PSCAD Analyses for Weak Grid Conditions</li> <li><input checked="" type="checkbox"/> Grid Forming Analyses</li> </ul>	<input checked="" type="checkbox"/> Ride-Through Requirements	<input checked="" type="checkbox"/> Unintended Islands <ul style="list-style-type: none"> <li><input checked="" type="checkbox"/> Transient Overvoltage (TrOV)</li> <li><input checked="" type="checkbox"/> Unintended Islands Fault Overvoltage (GFOV)</li> </ul>	<input type="checkbox"/> Harmonics <ul style="list-style-type: none"> <li><input type="checkbox"/> Harmonics Model Analysis</li> <li><input type="checkbox"/> Harmonics Monitoring Assessment</li> </ul>
Tasks															
(Include selected tasks in the IRS. Exclude tasks that are unselected)															
<input checked="" type="checkbox"/> Interconnection One-Line, Three-Line, and Equipment List															
<input checked="" type="checkbox"/> Project Data Requirements and Facility Technical Model Review															
<input checked="" type="checkbox"/> Review of Existing System Performance (Base-Case)															
<input checked="" type="checkbox"/> Develop Project Model (IRS Case)															
<input checked="" type="checkbox"/> Steady-State Power Flows <ul style="list-style-type: none"> <li><input checked="" type="checkbox"/> Reverse Power Flow</li> <li><input checked="" type="checkbox"/> Reactive Power Requirements</li> </ul>															
<input checked="" type="checkbox"/> Protection Review															
<input checked="" type="checkbox"/> Voltage Flicker															
<input checked="" type="checkbox"/> Voltage Transients (In-Rush Current)															
<input checked="" type="checkbox"/> System Stability <ul style="list-style-type: none"> <li><input checked="" type="checkbox"/> PSSE Analyses</li> <li><input checked="" type="checkbox"/> PSCAD Analyses for Weak Grid Conditions</li> <li><input checked="" type="checkbox"/> Grid Forming Analyses</li> </ul>															
<input checked="" type="checkbox"/> Ride-Through Requirements															
<input checked="" type="checkbox"/> Unintended Islands <ul style="list-style-type: none"> <li><input checked="" type="checkbox"/> Transient Overvoltage (TrOV)</li> <li><input checked="" type="checkbox"/> Unintended Islands Fault Overvoltage (GFOV)</li> </ul>															
<input type="checkbox"/> Harmonics <ul style="list-style-type: none"> <li><input type="checkbox"/> Harmonics Model Analysis</li> <li><input type="checkbox"/> Harmonics Monitoring Assessment</li> </ul>															
<b>Reference Single Line Diagram (See Appendix H)</b>	See Single Line Diagram for the site														



**DRAFT**  
**REQUEST FOR PROPOSALS**  
**FOR**  
**NORTH KOHALA**  
**ENERGY STORAGE**  
**ISLAND OF HAWAI‘I**

OCTOBER 29, 2021

Docket No. TBD

*Appendix C – Code of Conduct Procedures  
Manual*



**Maui  
Electric**

## I. INTRODUCTION

The Framework for Competitive Bidding ("Framework") adopted on December 8, 2006, by the Public Utilities Commission of the State of Hawaii (the "Commission") pursuant to Decision and Order No. 23121 (Docket No. 03-0372, Instituting a Proceeding to Investigate Competitive Bidding for New Generating Capacity in Hawaii) requires that the utility develop and follow a Code of Conduct whenever a utility or its affiliate seeks to advance a system resource proposal pursuant to a request for proposals ("RFP") issued by the Company. Section III.A.4 of the Framework required the utility to submit to the Commission for review and approval (subject to modification if necessary) a code of conduct prior to the commencement of any competitive bid process under the Framework. The proposed *Code of Conduct Pertaining to the Implementation of a Competitive Bidding Process for North Kohala Energy Storage RFP* (the "Code of Conduct") requires the Company to also propose this *Code of Conduct Procedures Manual* (the "Procedures Manual") to implement the requirements of the Framework and the Code of Conduct.

This Procedures Manual has been developed to outline the procedures to be followed and the policies that have been developed surrounding the implementation of the Company's competitive bidding process for system resources. This Procedures Manual has been developed for the Company's North Kohala Energy Storage RFP and in accordance with the requirements of Section IV.H.9.a(iii) of the Framework and outlines requirements (1), (3) and (4) of such section, namely: (1) the protocols for communicating with Proposers, the Hawaiian Electric Proposal team, and others; (3) the documentation forms, including logs for any communications with proposers; and (4) other information consistent with the requirements of the solicitation process. Requirement (2) of the section, the evaluation process in detail and the methodologies for undertaking the evaluation process for the RFP are described in detail in the North Kohala Energy Storage RFP. The bid evaluation process and methodology will consider both price/system impacts and non-price criteria in accordance with Section IV.E of the Framework

and Tariff Rule 19.

The procedures and policies set forth herein have been designed to ensure that the procurement process is undertaken in a fair and equitable manner and that each Proposer is afforded an equal opportunity to participate and compete within the RFP requirements.

This Procedures Manual is intended to be followed by Company personnel in connection with implementing the Company's solicitation process and to manage communications between Company personnel and consultants participating in the RFP processes covered by the Framework. Necessary additions, deletions, and/or changes depending on the circumstances surrounding the RFP and directions from the IO may be required.

## **II. DEFINITIONS**

- Affiliate – Any person or entity that possesses an “affiliated interest” in a utility as defined by section 269-19.5, Hawaii Revised Statutes (“HRS”), including a utility’s parent holding company but excluding a utility’s subsidiary or parent which is also a regulated utility.
- Affiliate Team – Employees and consultants of an Affiliate of the Company who prepare a proposal to be submitted to the Company in response to a Company RFP.
- ATRs – The Affiliate Transaction Requirements, issued by the Commission, applicable to the Companies and Affiliates, attached as Exhibit B to Order No. 36112 issued on January 24, 2019 in Docket No. 2018-0065.
- Code of Conduct – The *Code of Conduct Pertaining to the Implementation of a Competitive Bidding Process for North Kohala Energy Storage RFP* developed by Hawaii Electric Light Company, Inc. (“Company”) to ensure the fairness and integrity of the competitive bidding process, in particular where the host utility or its affiliate seeks to advance its own system resource proposal in response to an RFP. The Code of Conduct follows the requirements described in Section IV.H.9.c of the Framework.

- Code of Conduct Acknowledgement – The Competitive Bidding Code of Conduct Acknowledgement of Receipt form acknowledging review of, and agreeing to abide by, the Code of Conduct and this Procedures Manual.
- Communications Log – A written record to note activities and/or information shared between the Company RFP Team or Hawaiian Electric Proposal Team with Shared Resources or Unassigned Company Resources, accessed via the RFP Communication Tool Kit SharePoint Site.
- Company Executive in Charge – The Company executive responsible for ensuring compliance with this Code of Conduct and serving as the point of contact for the Independent Observer for reporting any violations by the Company of the Code of Conduct. The Company Corporate Compliance Officer shall remain responsible for the Company's independent corporate code of conduct and may support compliance matters and questions arising with employees, agents and other representatives of the Company, e.g., conflicts of interest, with respect to this Code of Conduct.
- Company RFP Team – The Company personnel and outside consultants responsible for the development of the Company's RFP conducted under the Framework and the evaluation of bids submitted in response to this RFP. Subject to the transfer rules specified herein, the Company RFP Team will have fixed team members who will not have any involvement with the Hawaiian Electric Proposal Team for this RFP.
- Hawaiian Electric Proposal Team – The Company personnel and outside consultants responsible for the development of the Hawaiian Electric Proposal Team responses to the RFP. Subject to the transfer rules specified herein, the Hawaiian Electric Proposal Team will have fixed team members who will not have any involvement with the Company RFP Team for this RFP.
- Confidential Information – Any non-public information developed and provided by the Company (i.e., proprietary system information, etc.) or Proposers during the RFP process (such non-public information may include, for example, the identity of competing Proposers, and their technical, trade or financial information). This term includes any material non-public information regarding the RFP process developed for and used during the competitive bidding solicitation process, such

as the evaluation process or criteria. Confidential Information does not include public information, such as information in the Company's public filings with the Commission.

- Director of Renewable Acquisition – The supervisor of the Division that will oversee the Company's competitive bidding process.
- Eligible Proposer – A Proposer who has met the minimum requirements and threshold requirements in the RFP necessary to remain eligible to compete in the process.
- Energy Contract Manager – The staff position(s) within the Company's Renewable Acquisition Division responsible for managing the Company RFP Team. The Energy Contract Manager shall be a member of the Company RFP Team.
- Framework – The Framework for Competitive Bidding contained in Decision & Order No. 23121 issued by Commission on December 8, 2006, to establish rules for competitive bidding in response to a request for proposals when a utility seeks to acquire new system resources.
- Independent Observer ("IO") – The neutral person or entity appointed by either the Commission or utility to monitor the utility's competitive bidding process, and to advise the utility and Commission on matters arising out of the competitive bidding process, as described in Part III.C of the Framework.
- Manager of Energy Procurement - The supervisor of the department within the Company's Renewable Acquisition Division responsible for directing the resources responsible for the implementation of the competitive bidding process pursuant to the Framework. The Manager of Energy Procurement will report to the Director of Renewable Acquisition on the status of the competitive bidding process and shall be a member of the Company RFP Team.
- Non-Price Evaluation Team – Employees and consultants of the Company who evaluate the Proposal non-price related criteria as set forth in the RFP. Non- Price Evaluation Team members will not include any Shared Resources and will be solely made up of Company RFP Team Members.
- Price Evaluation Team – Employees and consultants of the Company who evaluate the Proposal price related criteria set forth in the RFP. Price Evaluation Team members will not include any Shared Resources and will be solely made up of

Company RFP Team Members.

- Proposer – Entity who submits or plans to submit a proposal in response to a Company-issued RFP. An Affiliate of the Company or a Hawaiian Electric Proposal Team participating in the RFP and submitting a proposal shall be considered a Proposer.
- RFP – A written request for proposals issued by the Company to publicly solicit bids to supply future system resources to the Company pursuant to the competitive bidding process established in the Framework.
- Roster – A consolidated list of members that comprise the Company RFP Team, Hawaiian Electric Proposal Team, Shared Resources and Unassigned Company Resources located in the RFP Communication Tool Kit SharePoint Site. Names and roles of Company employee and consultants will be identified.
- Shared Resource – Company employees and consultants who, because of the scarcity of their expertise within the Company, are designated and authorized to provide information or input to both the Company RFP Team and the Hawaiian Electric Proposal Team (but not any Affiliate Team) and is not a resource dedicated to either team. For example, Shared Resources may include an environmental attorney and members of the Company’s Risk Management Department.
- Unassigned Company Resource – Company employees unassigned to an essential team that may be called upon by the Company RFP Team and/or the Hawaiian Electric Proposal Team (but not any Affiliate Team) to assist in meeting unforeseen tasks for the RFP or the Hawaiian Electric Proposal Team proposal. For example, the Company RFP Team may be unable to evaluate an unforeseen technical specification included in a bid. In that event, the Company RFP team would need to request assistance from a Company employee or a consultant that is not already assigned to an essential team and possesses the specific expertise. Such personnel are intended to assist the requesting team only in an ad hoc manner, limited in scope and purpose to the particular task required.

### **III. STATEMENT OF OBJECTIVES**

The Code of Conduct and this Procedures Manual address (1) communication requirements and procedures associated with the relationship between utility employees

(Company RFP Team, Hawaiian Electric Proposal Team, Shared Resources and Unassigned Company Resources); (2) communication requirements and procedures associated with the relationship between the Company RFP Team, the Hawaiian Electric Proposal Team and Proposers; and (3) communication requirements associated with the relationship between Company management and the Company RFP Team.

The Code of Conduct and this Procedures Manual also include procedures for the sharing of resources, where appropriate, by the Company RFP Team and the Hawaiian Electric Proposal Team for the purposes of completing their efforts to effectively evaluate the RFP or to submit a bid in response to the RFP. The small size of the Company and limitation of resources will require specialized services, information exchange and sharing of resources in certain limited circumstances. Company personnel and consultants identified as "Shared Resources" shall be designated by the Company for this specific purpose.

#### **IV. ORGANIZATION AND COMMUNICATION RESPONSIBILITIES**

This section outlines the RFP organizational structure for the development of the RFP and the Hawaiian Electric proposal options and the organization's responsibilities to ensure that communications between Company personnel and consultants working on their respective RFPs or Hawaiian Electric projects are conducted in a fair, consistent, and equitable basis so that the Hawaiian Electric Team does not enjoy any unfair advantage over other Proposers responding to an RFP.

##### **A. Organization**

The Company shall identify and maintain two separate teams to facilitate the independence and objectivity of the Company resources working on the RFP and ensure an arms-length relationship with the resources working on the Hawaiian Electric project to avoid any real or perceived inequity in the RFP process. The two essential teams shall be the "Company RFP Team" and the "Hawaiian Electric Proposal Team."

Other limited Company resources, such as select staff from various functional

areas of the Company that are in short supply and thus cannot be dedicated solely to either team, may be designated as "Shared Resources" to perform services for the Company RFP Team and Hawaiian Electric Proposal Team. Shared Resource employees are allowed to carry on with both their RFP (for either the Company RFP Team and/or the Hawaiian Electric Team) and regular functions throughout the resource planning process (including the development of any Company Parallel or Contingency Plan as defined in the Framework), which may require communications with or services performed for the Hawaiian Electric Proposal Team. Shared Resource employees, however, will not participate in the evaluation and selection process of proposals submitted in response to the RFP. Rules for communications between Shared Resources and the essential teams are specified below.

Company employees unassigned to the RFP may be called upon by the Company RFP Team, Hawaiian Electric Proposal Team, or both for help to meet unforeseen tasks. After completing the Code of Conduct training, these "Unassigned Company Resources" are eligible to assist on an ad hoc basis with the requirement that all communications as an Unassigned Company Resource must be memorialized and logged in the same manner as communications with Shared Resources on the Communication Log. If an Unassigned Company Resource is called upon repeatedly for a substantial amount of assistance by a particular team, the employee should be assigned to such team or evaluated for designation as a shared resource.

## **B. Essential Teams**

1. Company RFP Team. The Company RFP Team, tasked with preparing the RFP and evaluating the responses and bids in response to the RFP, will be led by a Director/Manager level employee and consist primarily of experienced employees together with possible outside consultants, with backgrounds in a number of disciplines necessary to conduct a thorough evaluation of each proposal. The Company RFP Team will be comprised of a Price Evaluation Team and a Non-Price Evaluation Team and will be prepared to evaluate proposals on the basis of their price and non-price aspects pertaining to their level of expertise. Members of the Company RFP Team will include



professionals with experience in the following areas of expertise: engineering, siting/land use, environmental, transmission planning, fuel procurement, legal, financial planning, system operations, integrated resource planning, generation planning, production cost analysis, and others as needed.

The Price Evaluation Team and the Non-Price Evaluation Team will conduct their sections of the bid evaluation process separately and will not share the results of their evaluation with members of the other sub-team. Each team will submit their evaluation results to an oversight team, which will be responsible for compiling the results of the evaluations and selecting the Priority List.

The Energy Contract Manager will be responsible for directing the evaluation efforts of the Company RFP Team when the proposals are received. The Energy Contract Manager will be responsible for maintaining the documentation underlying the evaluation of each proposal as well as all communications with Proposers.

2. The Hawaiian Electric Proposal Team. The Hawaiian Electric Proposal Team, tasked with preparing any Company proposal to be submitted by the Company in response to the Company RFP, will consist primarily of Company employees, along with possible outside consultants with backgrounds in a number of disciplines necessary to complete a competitive proposal in response to the Company RFP. The members of the team will include professionals with experience in the following areas of expertise: engineering, siting/land use, environmental, transmission planning, fuel procurement, legal, financial planning, system operations, integrated resource planning, generation planning, production cost analysis, and others as needed.

3. Affiliate Team. Any Affiliate Team will be comprised solely of employees and consultants of the Affiliate and no Company employee or consultant shall serve as a member of an Affiliate Team; provided, however, that a consultant may perform services for an Affiliate and the Company so long as appropriate "walls" are established satisfactory to the Company that ensures that employees of the consultant working for the Affiliate Team do not also perform work for the Company nor communicate with employees of the consultant performing work for the Company, and vice versa. The

Company will inform consultants providing services for the Company RFP Team of these separation requirements, and will seek confirmation in writing from any consultant performing services for an Affiliate and the Company that such separation requirements will be met. Affiliate Teams will be considered and treated as separate independent third-party Proposers for all purposes within the RFP and shall have no access to, interaction or communications with Shared Resources or Unassigned Company Resources for the purpose of completing a proposal in response to the RFP. Affiliate Teams shall also be subject at all times to the terms, conditions and restrictions specified in the Company's ATRs.

4. Transfers between Teams. As members of both the Company RFP Team and the Hawaiian Electric Proposal Team are intended to be fixed, transfers between teams should not be permitted. However, there will be instances where a member of a particular team (whether Company RFP or Hawaiian Electric Proposal) transfers to a position in which he/she may be requested, as part of his/her new job responsibilities, to participate as a member of the other team. Such employee shall not be permitted to transfer from one team to the other during the pendency of the RFP (or stage or phase of the RFP). After completion of the RFP (or stage or phase of the RFP) under which the employee recently participated, the employee may transfer to the other team under the following conditions: (a) the employee is prohibited from disclosing any Confidential Information known to such employee as a result of being a member of his/her former team with members of the new team he/she is joining; and (b) for a period of one (1) year, such employee shall not: (a) participate or be involved in establishing the evaluation criteria and the evaluation of any subsequent stage(s) or phase(s) of the RFP which such employee participated in with his/her former team; or (b) participate or be involved in the formulation and/or origination of a proposal for any subsequent stage(s) or phase(s) of the RFP which such employee participated in with his/her former team.

Transfers of employees between the Company and any Affiliate and their subsequent work on RFPs shall be subject to the terms, conditions and restrictions specified in the ATRs.

**C. Communications Protocols**

## **1. Overview and General Requirements.**

The Company has developed policies and procedures governing communication between the Company RFP Team, the Hawaiian Electric Proposal Team, Shared Resources, the Proposers, the IO, and with the Commission regarding RFP design and bid evaluation. Bid information and evaluation data and information shall not be communicated between members of the Company RFP Team, outside parties and other employees within the Company except to those with a business need to know.

To ensure that the competitive bidding process is fair and unbiased, that all Proposers have access to the same information so that no Proposer has an unfair advantage, and that any Hawaiian Electric proposals and/or Affiliate proposals do not have any unfair competitive advantage over third-party bids, the Company shall follow the Code of Conduct whenever the utility or its Affiliate is seeking to advance a resource proposal as provided in Section IV.H.9.b of the Framework.

Each employee or consultant on the Company RFP Team, Hawaiian Electric Team and Shared Resources shall read, acknowledge and sign the Code of Conduct Acknowledgement. Unassigned Company Resources who are called upon by the Company RFP Team or Hawaiian Electric Proposal Team for help to meet unforeseen tasks shall also read, acknowledge and sign the Code of Conduct Acknowledgement.

The Company issuing the RFP will establish a shared drive on its corporate computer network designed to maintain the bid evaluation documentation and other information associated with the bidding process. Only Company RFP Team members will have access to all the files on the shared drive.

In cases where staffing and resources are limited or constrained, the Company may identify Shared Resources or those employees eligible to provide information or serve as a resource to both the Company RFP Team and the Hawaiian Electric Proposal Team. Specific rules to log communications with the Company RFP Team or the Hawaiian Electric Proposal Team are described below.

Shared Resources will not have access to the Company's shared drive established for the RFP process which will include the documentation of the bid evaluation results.

Team members should clearly mark all e-mails, documents, or other communications that contain Confidential Information and make clear which team should not receive it with the following header or a substantially similar message: "This communication contains Hawaiian Electric proposal information that must be kept confidential. DO NOT copy, forward, or discuss the contents with Company RFP Team members" OR "This communication contains Company RFP Team information that must be kept confidential. DO NOT copy, forward, or discuss the contents with Hawaiian Electric Proposal Team members."

## **2. Communications Between the Company RFP Team and Proposers, including the Hawaiian Electric Proposal Team and any Affiliate Team.**

During the RFP process, the Energy Contract Manager shall serve as the primary contact person for all RFP communications with Proposers. This is important from the standpoint of maintaining consistency and confidentiality of information between Proposers and the Company. For documentation and oversight purposes, all communications from Proposers must be submitted via the communication means specified in the RFP (e.g. specified website link provided by the Company (the "Company RFP website"), specified RFP electronic procurement platform, and/or specified RFP electronic mail address ("email")). The IO will monitor all communications through any communication means specified in the RFP. To ensure fair and equal access to information, any Hawaiian Electric Proposal Team and/or Affiliate Team shall be considered a Proposer for communication purposes and any request for information from the Hawaiian Electric Proposal Team or Affiliate Team to the Company RFP Team shall be through the communication means specified in the Company RFP.

Subject to confidentiality obligations, it is the objective of the Code of

Conduct that all Proposers, including the Hawaiian Electric Proposal Team and any Affiliate Team, receive access to information released by the Company RFP Team, whether in response to a question from a Proposer or not, at the same time.

The communications process for addressing questions and requests for information from Proposers, and for the Company RFP Team to provide information to Proposers, is provided below:

- a. Other than during Company sponsored conferences, Proposers must submit all questions to the Company via the communications means specified in the RFP.
- b. Questions will be reviewed and responses will be coordinated with the appropriate functional area within the Company for a response. Every reasonable effort will be made to provide responses in a timely manner.
- c. All responses, including the classification of such response, i.e., whether non-confidential or confidential as described below, will be made available to the IO for monitoring purposes. The IO may choose to comment on any response at its discretion.
- d. Depending on the questions received, responses may involve Confidential Information of the Company and/or Proposers. Release of any Company Confidential Information must be approved in advance by the Company executive authorized to release the Confidential Information. Any release of Company Confidential Information shall be accompanied by appropriate confidentiality and non-disclosure agreements, protective orders or other means required to maintain the confidentiality of the Company Confidential Information while still permitting its disclosure under circumstances deemed appropriate by the responsible Company executive. Other non-Company Confidential

Information will not be shared without the prior written consent of the owner of such Confidential Information and the execution of appropriate confidentiality and non-disclosure agreements by all recipients of such Confidential Information. Responses will be categorized as follows:

i. Non-Confidential Responses: Questions and responses will either be posted directly on the Company RFP website (process-related questions or simple, non-substantive information) or a description of the information that can be made available will be posted and Proposers will be instructed to submit a request to the Company via the communication means specified in the RFP to receive a copy.

ii. Confidential Responses: Questions and a description or notice of a Confidential Information response will be posted on the Company RFP website and Proposers will be instructed to submit a request to the Company via the communications means specified in the RFP to receive instructions on how to access the Confidential Information. The Confidential Information will only be provided to the requestor after receipt of an executed confidentiality and non-disclosure agreement. Only those who have qualified to submit a bid (i.e., Eligible Proposers) and have executed a confidentiality and non-disclosure agreement will be considered for receipt of Confidential Information.

iii. Process for Distribution of Confidential Information: Confidential Information provided in response to questions from proposers may be made available only to parties as indicated above via the following:

A. Confidential Information that is approved for

exchanging on a secured access site: (1) Confidential Information may be made available on a secured website with an individual password provided to each approved Proposer; and (2) Confidential Information in documents may be transmitted to approved recipients through the Company's secure email system.

B. Confidential Information that can be made available for inspection only, but cannot be copied: There may be some types of Confidential Information that the Company may consider making available for inspection only with no copies allowed. This type of Confidential Information will be made available on Company premises for inspection only. Proposers will be advised via the communications means specified in the RFP to make arrangements with Company staff to view the Confidential Information.

C. Confidential Information that may not be released: In the event that Proposers submit questions that require responses that the Company feels are not appropriate to provide for reasons which may include, but not be limited to, safety, security, protection of trade secrets or intellectual property rights, Proposers will be advised as such via the communication means specified in the RFP.

- e. Prior to and during the RFP, developers may direct questions to the Company prior to submitting a Proposal to discuss specific questions regarding their specific Proposal. Questions shall be directed to the communication means specified in the. Questions and responses that do not contain Confidential Information and which are deemed relevant to all Proposers will be published without identifying information via the Company RFP website.

- f. Once bids are received, the Company may submit information requests to Proposers to clarify their proposals or request additional information. All contacts with Proposers will be through the communication means specified in the RFP. All contacts and information exchanged will be under the oversight of the IO.
  
- g. A single exception to the communication process outlined above shall be instituted for the purpose of facilitating the verification of proposed project models and documentation required to perform the IRS. For this limited scope, the Company's Manager of Interconnection Services will serve as the primary contact person for all such interconnection communications with the Proposers on the Priority List, provided that all necessary confidentiality and non-disclosure agreements are in place. The Manager of Interconnection Services and personnel in the Interconnection Services Department shall be members of the Company RFP Team. Interconnection communications will be limited to a Proposer's bid and no more information other than as necessary to facilitate such communications will be permitted. Discussion of locations of proposed projects shall be limited to that necessary only to determine the interconnection requirements of such project. The IO shall have the right to monitor all such communications in his/her discretion.

### **3. Communications Between the Company and the Commission.**

The Company's Regulatory Affairs staff will be responsible for initiating communication with the Commission regarding the RFP or the Company's evaluation process. Regular updates may be provided to the Commission regarding the RFP process if requested.



**4. Communications Between the Company RFP Team and the IO.**

Communications between the Company RFP Team and the IO will be required for many aspects of the evaluation process. The IO is also required to maintain confidentiality of any Confidential Information. The IO will coordinate all activities through the Energy Contract Manager. The IO will be invited to participate in any meetings or discussions between the Company RFP Team and the Proposers and other communications as noted above. Sufficient notice will be provided whenever possible and teleconference and/or web conference alternatives may be utilized.

**5. Communications Between the Company RFP Team and the Hawaiian Electric Proposal Team or any Affiliate Team.**

Any communication between the Company RFP Team and the Hawaiian Electric Proposal Team or any Affiliate Team with respect to the RFP shall be handled no differently than with Proposers and other outside parties. Accordingly, the Hawaiian Electric Proposal Team or any Affiliate Team will be required to submit any questions or information requests to the Company RFP Team via the communication method specified in the RFP and all responses will be provided in the same manner as to other Proposers. Accordingly, as stated in Section 2 above, responses will be provided to the IO for monitoring purposes via email or the PowerAdvocate messaging system. Members of the Company RFP Team are prohibited from providing any input into the development of the Hawaiian Electric proposal option by the Company or an Affiliate. Company RFP Team members are prohibited from sharing any Confidential Information (i.e., detailed evaluation criteria, other proposals, etc.) with any Hawaiian Electric Proposal or Affiliate Teams except in accordance with the procedures in the Code of Conduct, this Manual or the RFP.

Company RFP Team members and Hawaiian Electric Proposal Team members may continue to work with each other on projects not related to the RFP.

Further, members of each respective team do not have to be physically separated from each other, but members of each team must make reasonable efforts to keep all Confidential Information (including electronic data) secure and inaccessible to the other team.

Company RFP Team members and Affiliate Team members may continue to work with each other on matters not related to the RFP as permitted under the ATRs.

**6. Communications among the Company RFP Team, the Hawaiian Electric Proposal Team and Shared Resources.**

Shared Resources may provide services to the Company RFP Team and the Hawaiian Electric Proposal Team (but not any Affiliate Team). Shared Resources shall be limited as much as possible to instances where Company resources cannot provide a dedicated member to the Company RFP Team and the Hawaiian Electric Proposal Team at the same time and still provide the necessary functions of its area to the Company as a whole. Shared Resources are expressly prohibited from providing any information developed on behalf of the Company RFP Team to the Hawaiian Electric Proposal Team or any information developed on behalf of the Hawaiian Electric Proposal Team with the Company RFP Team, except through the formal communication process outlined above, i.e., through the communication means specified in the RFP.

Additionally, a written record of the time, date and substance of all conversations, data and written material directly or indirectly exchanged with the Company RFP Team or the Hawaiian Electric Proposal Team that pertain to the RFP shall be maintained on the Communications Log. The RFP Communication Tool Kit SharePoint Site will be set up and managed by the Energy Contract Manager to provide an easy to use and understand mechanism to log and memorialize these conversations.

Shared Resources will not have direct access to the Company's shared drive developed for the RFP process which will include documentation of the bid evaluation

results.

**7. Communications between the Company RFP Team, the Hawaiian Electric Proposal Team and any Unassigned Company Resource or consultant that is not a Shared Resource.**

There may be times where a Company RFP or Hawaiian Electric Proposal team (but not an Affiliate Team) member may need ancillary or other ministerial or administrative assistance that requires communication and/or assistance from Company personnel who are neither on any team nor considered a Shared Resource. Under those circumstances, such personnel may assist the requesting team member on an ad hoc basis upon the following conditions:

- a. The essential team member making the request must inform the Company personnel that sharing of the requested information or assistance with the other team, be it the Company RFP or Hawaiian Electric Proposal Team, is expressly prohibited under the Code of Conduct.
- b. The assisting Company personnel shall complete the Code of Conduct training and sign the Code of Conduct Acknowledgement.
- c. The assisting Company personnel shall be directed to the Roster provided by such requesting team member to determine and/or confirm the restrictions on communication with the other team members. The essential team member making the request will ensure the Roster is updated by the Energy Contract Manager to include the assisting Company personnel.
- d. A written record of the time, date and substance of all conversations, data and written material directly or indirectly exchanged with the Company RFP Team or the Hawaiian Electric Proposal Team that pertain to the RFP shall be maintained on the Communication Log. The RFP

Communication Tool Kit SharePoint Site will be set up and managed by the Energy Contract Manager to provide an easy to use and understand mechanism to log and memorialize these conversations.

e. If assistance from an Unassigned Company Resource becomes more than occasional or more substantive than ancillary, ministerial or administrative services, the Unassigned Company Resource should be considered for inclusion on the team that he/she has been assisting on such basis. Additionally, the Unassigned Company Resource may also be considered for inclusion as a Shared Resource. Members of the Company RFP Team and/or Hawaiian Electric Proposal Team shall consult with the Company executive for resolution.

**8. Communications between the Company RFP Team, the Hawaiian Electric Proposal Team and Company Management.**

The Company RFP Team and the Hawaiian Electric Proposal Team will necessarily require management approval of the RFP and the Hawaiian Electric Proposal Team proposal. Because of the size of the Company, it may be possible that a single employee (at whatever level) (the "Approver") may have approval responsibility for matters affecting the RFP and the Hawaiian Electric Proposal Team proposal. Approvers in this situation must use their best judgment in making decisions reviewing and approving matters for the respective teams. The Code of Conduct must be adhered to in these situations and the Approver must not communicate matters learned from the Company RFP Team with the Hawaiian Electric Proposal Team.

If an Approver feels that he/she cannot manage this potential conflict, the Approver is recommended to consult with his/her immediate supervisor to determine whether such higher authority could be appointed with the task of reviewing and approving matters for a designated team, either the Company RFP Team or the Hawaiian Electric Proposal Team. In matters where a team of employees (including one or more Approvers) is responsible for reviewing and approving matters for the respective teams,

approving employees (from whatever level, including executives) with information from reporting personnel beneath them from both the Company RFP Team and the Hawaiian Electric Proposal Team may consider recusing himself/herself from the decision making if such employee cannot objectively make a decision on the matter.

Finally, an Approver may be a member of the Company RFP Team and have a subordinate reporting to him/her that is a member of the Hawaiian Electric Proposal Team (or vice versa). In such situations, because the Code of Conduct prohibits communication between the teams, the Approver must recuse himself/herself from the decision making and request his/her manager to review and approve the matter in his/her place.

In all instances, it is possible that any particular situation above may be addressed and/or resolved by the terms and conditions of the Company's internal code of conduct implemented for all employees and consultants of the Company. As appropriate, an Approver or any other team member, Energy Contract Manager or Company executive in Charge may involve the Company's Corporate Compliance Officer for input and possible resolution under the Company's internal corporate code of conduct.

## **V. WHEN THE CODE OF CONDUCT BECOMES EFFECTIVE**

A. Prior to development of the requirements for the RFP, the Code of Conduct for the RFP will be activated. However, if the Hawaiian Electric Proposal Team determines at any time that it will not pursue a Hawaiian Electric option for the RFP, the Code of Conduct may be de-activated.

B. Upon the activation of the Code of Conduct, members of the Company RFP Team and the Hawaiian Electric Proposal Team must then conduct activities on the RFP or Hawaiian Electric proposal process in compliance with the Code of Conduct. Once identified and having commenced work, no information may be shared outside the respective team members with respect to the RFP or a Hawaiian Electric Proposal Team option except through the formal communication processes outlined above.

C. Immediately upon assignment to a Company team (RFP or Hawaiian

Electric Proposal), designation as a Shared Resource, or request to assist as an Unassigned Company Resource, each such employee or consultant must review this Manual, and sign the Code of Conduct Acknowledgement.

D. Within the RFP process, after a member has been assigned to a particular Company team (RFP or Hawaiian Electric Proposal), he or she will not be able to transfer to the other Company team during the pendency of any particular stage or phase of a particular RFP. Transfers of members of any particular team to another team after the RFP, or a particular stage or phase of the RFP, is completed shall be governed by the transfer rules specified herein. It is the responsibility of each team to fill vacant team positions with employees that have not been previously assigned as a team member for a team until the RFP, or the particular stage or phase of the RFP, has been completed.

E. Each employee and consultant working on the RFP shall review the Code of Conduct and sign the Code of Conduct Acknowledgement attesting to his/her compliance with the Code of Conduct until the employee is no longer working in the position he/she was in while working on the RFP.

F. The Energy Contract Manager will be responsible for maintaining the Roster and the signed Code of Conduct Acknowledgements. The Company Executive in Charge shall be responsible for ensuring compliance with the Code of Conduct and shall have the written authority and obligation to enforce the Code of Conduct.

## **VI. IMMEDIATE ACTIONS UPON ACTIVATION OF THE CODE OF CONDUCT**

The following items are required to be completed as soon as possible after activation of the Code of Conduct, but no later than the designated events specified for each item below.

A. Prior to development of the requirements for the RFP, a Roster listing employees and consultants in their role; Company RFP Team, Hawaiian Electric Proposal Team, Shared Resource or Unassigned Company Resource, will be generated. When the

IO is appointed, this Roster shall be provided to him/her. The Roster shall be placed in the RFP Communication Tool Kit SharePoint Site so that any Company personnel can access the database to determine the identity of the respective teams and Shared Resources.

B. Upon the finalization of the Roster for the RFP, the Energy Contract Manager shall verify that all employees (whether full-time, part-time, temporary, or contract) and consultants involved in the competitive bidding process, such as members of the Company RFP Team, the Hawaiian Electric Proposal Team, Shared Resources or Unassigned Company Resources, have acknowledged receipt of the Code of Conduct and his or her responsibility to comply with the Code of Conduct by submitting the Code of Conduct Acknowledgement (with electronic acknowledgment being acceptable). If an employee or consultant is later added to a team, the Energy Contract Manager shall also verify that such employee or consultant has submitted the Code of Conduct Acknowledgment.

C. Prior to any solicitation for comments or questions to the RFP, establishment of the Company email address to accept requests for information from Proposers, including the Hawaiian Electric Proposal Team or any Affiliate Team.

D. Prior to the drafting of any documents for any particular RFP, establishment of the Company-secured site that houses the accessible database (such as SharePoint).

## **VII. WHEN THE CODE OF CONDUCT TERMINATES**

- A. The Code of Conduct for the RFP will terminate after the following two conditions are met when:
- the final contract(s) for the RFP conducted under the Framework with the successful proposer(s) is/are executed, or when written notice of termination of the RFP to be conducted under the Framework is provided by the Manager of Energy Procurement or his/her designee to the IO and the Commission, and

- a certification of Code of Conduct compliance by all employees participating in the RFP process is submitted by affidavit by the Company Executive in Charge.

### **VIII. DOCUMENTATION FORMS**

The following documentation forms may be utilized by those Company personnel involved in the RFP. These forms may be amended from time to time as necessary. Additional forms may also be developed as determined necessary.

- Code of Conduct Acknowledgement
- Communications Log
- Roster

### **IX. APPLICABILITY OF THE ATRs**

Except as specifically made applicable under Section V.C.1.i of the ATRs with respect to wholesale power procurement from Affiliates, the ATRs shall not apply to RFP matters covered by the Framework, the Code of Conduct and this Procedures Manual as it relates to the Company's interactions between the Company RFP Teams and Affiliate Teams. Reference to the ATRs in the Code of Conduct and/or this Manual are specifically for matters outside the Company's administration of the RFP; provided, however, that such applicability may be revised as necessary and as may be directed by the Commission for any RFP.<sup>1</sup>

---

<sup>1</sup> See Decision and Order No. 35962, filed on December 19, 2018, in Docket 2018-0065, at 56-57.



**DRAFT**

**REQUEST FOR PROPOSALS**

**FOR**

**NORTH KOHALA**

**ENERGY STORAGE**

**ISLAND OF HAWAI‘I**

OCTOBER 29, 2021

Docket No. TBD

*Appendix D – PowerAdvocate User Information*



**Hawai'i  
Electric  
Light**



## Sourcing Intelligence Quick Start for Suppliers

### Logging In

1. Launch a web browser and go to [www.poweradvocate.com](http://www.poweradvocate.com)
2. Click the orange **Login** button.
3. Enter your account **User Name** and **Password** (both are case-sensitive) and click **Login**.
4. Click the **Events** tab if it is not already displayed.

### Dashboard

Your Dashboard lists the events you have been invited to. A line divides currently accessible events from others.

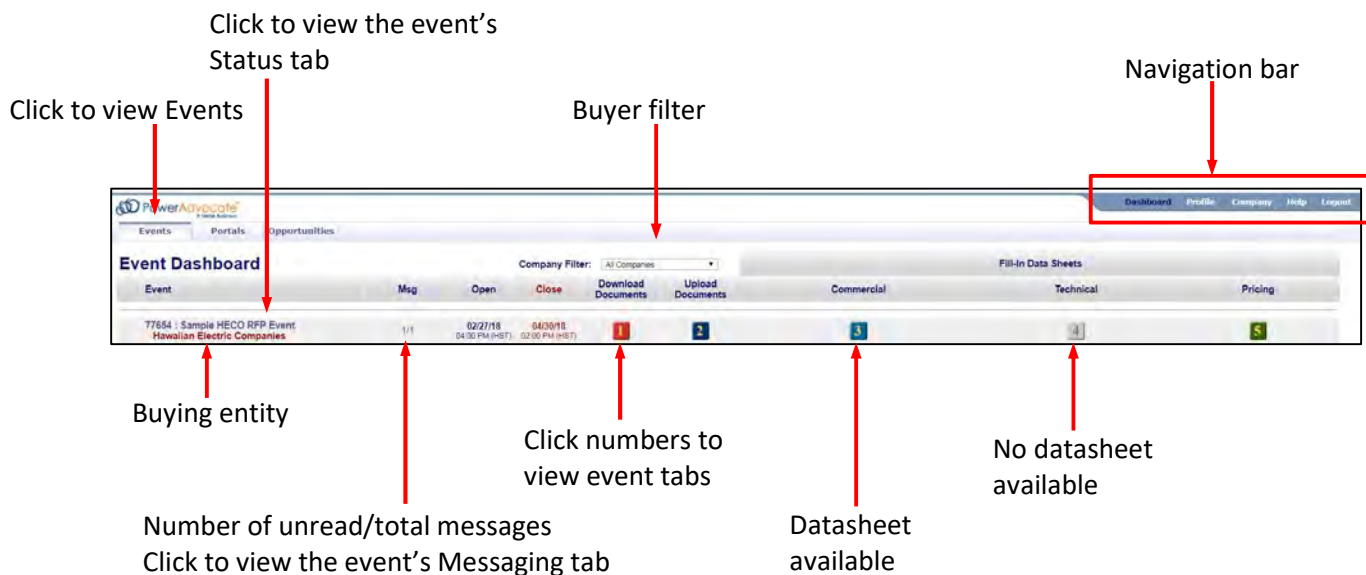

- Click an event name to view its Status tab, which displays a summary of your activity and key event dates. To view specific details of an event, click the buttons 1-5 to view the corresponding tab.
- To return to the Dashboard, click **Dashboard** in the navigation bar at the top of the window.
- An event will not appear on your Dashboard until you have been added as a participant.



## Downloading Bid Packages

All of the Buyer’s bid package documents (if any) are centrally stored on the PowerAdvocate Platform. To view bid documents, click “1” on your Dashboard or on the **1. Download Documents** tab from within the event.

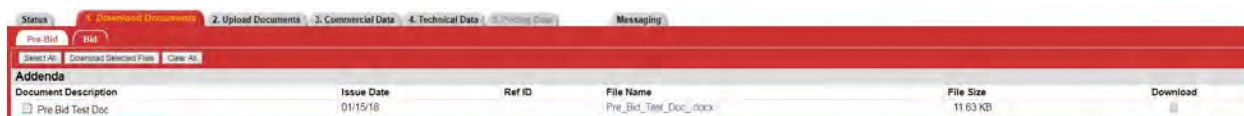

- You can access the **Bid** sub-tab after the event opens. You can access Buyer documents before the event is opened from the **Pre-Bid** sub-tab, if the Buyer utilizes this feature.
- To view or download a document, click the file name.
- To download multiple documents:
  1. Select the checkbox in the Download column for each document you wish to download or click **Select All**.
  2. Click **Download Selected Files**.

## Uploading Documents

To upload your documents, click “2” on your Dashboard, or on the **2. Upload Documents** tab from within the event.



- Do not upload any files to the Pre-Bid tab.
- To upload a document to the Bid tab:
  1. Specify a **Document Type** (Reference ID can be left blank).
  2. Click **Choose File**, navigate to and select the document, and then click Open; multiple files can also be compressed into one .zip file for upload.
  3. Click **Submit Document**.



## Datasheets

Datasheets (3. Commercial Data, 4. Technical Data, 5. Pricing Data) will not be used in this RFP event. All Proposal information will be uploaded for submission through the 2. Upload Documents tab. Buttons/tabs are grayed out if the event is not using a particular type of datasheet.



## Communicating with the Bid Event Coordinator /Company Contact

Suppliers should use Email to contact the Bid Event Coordinator /Company Contact while the bid event is open. In these CBRE RFPs, PowerAdvocate Messaging will not be used.

## Getting More Information

- Click **Help** on the navigation bar to display online help.



- Supplier documentation can be downloaded from the online help system.
- Call PowerAdvocate Support at 857-453-5800 (Mon-Fri, 8 a.m. to 8 p.m. Eastern Time) or e-mail [support@poweradvocate.com](mailto:support@poweradvocate.com).

**DRAFT**  
**REQUEST FOR PROPOSALS**  
**FOR**  
**NORTH KOHALA**  
**ENERGY STORAGE**  
**ISLAND OF HAWAI‘I**

OCTOBER 29, 2021

Docket No. TBD

*Appendix E – Mutual Confidentiality and  
Non-Disclosure Agreement*

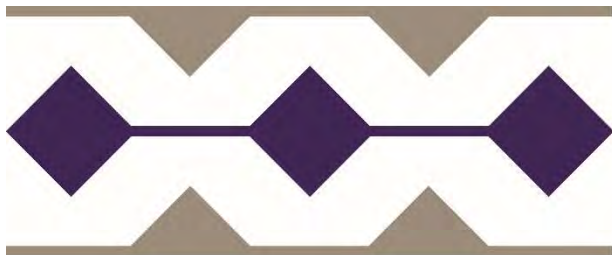

**Hawai‘i  
Electric  
Light**

**APPENDIX E**  
**MUTUAL CONFIDENTIALITY AND NON-DISCLOSURE AGREEMENT**  
Independent Power Producers – (“IPPs”)

This Mutual Confidentiality and Non-Disclosure Agreement (this “Agreement”) is effective as of \_\_\_\_\_, 20\_\_\_\_ (the “Effective Date”) between [INSERT NAME OF IPP], a [State of incorporation/organization] [type of entity] (“IPP”) and Hawaiian Electric Company, Inc., Maui Electric Company, Limited, and Hawaii Electric Light Company, Inc., each a Hawaii corporation (collectively, the “Companies”). In consideration of the mutual promises contained in this Agreement, including the provision of Confidential Information (as defined below) by either party to the other hereunder, and other good and valuable consideration, the receipt and sufficiency of which are hereby acknowledged, the parties agree as follows:

1. Background

The Companies have or intend to issue a Request for Proposals (“RFP”) for Community-Based renewable energy projects. The IPP has or intends to submit one or more proposals for a nominal [ ] MW [TYPE OF FACILITY] facility located at [LOCATION] on the island of [ISLAND], State of Hawai‘i (“Proposal”).

In connection with the IPP’s proposed project, the Companies may conduct an interconnection requirements study (“IRS”) to establish the requirements for interconnection of the IPP’s proposed project to the Companies’ electric grid. The RFP process may also result in the award of a potential energy storage services agreement, the terms of which must be agreed upon by the parties (“ESSA Negotiations”). For purposes of this Agreement the term “Project” refers to the RFP, Proposal, potential IRS and ESSA Negotiations.

In order to evaluate the Project, either party may from time to time provide to the other party certain Confidential Information. The parties are willing to provide such Confidential Information to each other upon the terms and conditions of this Agreement.

2. Confidential Information

Except as set forth in Section 3 (Exclusions from Confidential Information) below, “Confidential Information” means all non-public, confidential or proprietary information disclosed by either party (the “Provider”) to the other party (a “Recipient”) its affiliates and its and their directors, officers, employees, agents, advisors, consultants (including, without limitation, financial advisors, counsel and accountants) and controlling entities or individuals (collectively, “Representatives”) whether disclosed orally or disclosed or accessed in written, electronic or other form of media, and whether or not marked or otherwise identified as “confidential,” including, without limitation:

(a) all information concerning the Provider and its affiliates’, and their customers’, suppliers’ and other third parties’ past, present and future business affairs including, without limitation, finances, customer information, supplier information, products, services, designs,

processes, organizational structure and internal practices, forecasts, sales and other financial results, records and budgets, business, marketing, development, sales and other commercial information and strategies;

(b) information concerning the Companies' generation, transmission, and distribution systems (e.g., engineering and operating characteristics of the Companies' transmission lines and substations) ("Critical Infrastructure Confidential Information");

(c) the Provider's unpatented inventions (whether or not they are patentable), ideas, methods and discoveries, techniques, formulations, development plans, trade secrets, know-how, unpublished patent applications and other confidential intellectual property;

(d) all designs, specifications, documentation, components, source code, object code, images, icons, audiovisual components and objects, schematics, drawings, protocols, processes, and other visual depictions, in whole or in part, of any of the foregoing;

(e) any third-party confidential information included with, or incorporated in, any information provided by the Provider to the Recipient or its Representatives; and

(f) all notes, analyses, compilations, reports, forecasts, studies, samples, data, statistics, summaries, interpretations and other materials ("Notes") prepared by or for the Recipient or its Representatives that contain, are based on, or otherwise reflect or are derived from, in whole or in part, any of the foregoing.

### 3. Exclusions from Confidential Information

Except as required by applicable federal, state, or local law or regulation, the term "Confidential Information" as used in this Agreement shall not include information that:

(a) at the time of disclosure is, or thereafter becomes, generally available to and known by the public other than as a result of, directly or indirectly, any violation of this Agreement by the Recipient or any of its Representatives; provided, however, that Confidential Information shall not be disqualified as Confidential Information (i) merely because it is embraced by more general or generic information which is in the public domain or available from a third party, or (ii) if it can only be reconstructed from information taken from multiple sources, none of which individually shows the whole combination (with matching degrees of specificity);

(b) at the time of disclosure is, or thereafter becomes, available to the Recipient on a non-confidential basis from a third-party source, provided that such third party is not and was not prohibited from disclosing such Confidential Information to the Recipient by a contractual or other obligation to the Provider;

(c) was known by or in the possession of the Recipient or its Representatives, as established by documentary evidence, prior to being disclosed by or on behalf of the Provider pursuant to this Agreement;

(d) was or is independently developed by the Recipient, as established by documentary evidence, without reference to or use of, in whole or in part, any of the Provider's Confidential Information; or

(e) was or is learned of established entirely from public sources, as established by documentary evidence, without reference to or use of, in whole or in part, any of the Provider's Confidential Information.

The parties acknowledge and understand that the confidentiality obligations of this Agreement apply only to the Confidential Information shared in connection with the Project. The parties may share other information with each other under other agreements, provisions or understandings which are not related to the Project. Such information sharing shall be subject to the provisions of the agreements and confidentiality provisions associated thereto and this Agreement shall not be construed to infringe upon or apply to such agreements or provisions.

#### 4. Non-Disclosure of Confidential Information

Unless otherwise agreed to in writing by the Provider, the Recipient agrees as follows:

(a) except as required by law, not to disclose or reveal any Confidential Information to any person or entity other than its Representatives who are actively and directly participating in the evaluation of the Project or who otherwise need to know the Confidential Information for the purpose of evaluating the Project.

(b) not to use Confidential Information for any purpose other than in connection with its evaluation of the Project or the consummation of the Project.

(c) except as required by law, not to disclose to any person or entity (other than those of its Representatives who are actively and directly participating in the evaluation of the Project or who otherwise need to know for the purpose of evaluating the Project) any information about the Project, or the terms or conditions or any other facts relating thereto, including, without limitation, the fact that discussions are taking place with respect thereto or the status thereof, or the fact that Proprietary Information has been made available to the Recipient or its Representatives.

(d) to use diligent efforts to safeguard and protect the confidentiality of the Confidential Information, including, at minimum, implementing the same commercial measures that the Recipient uses to protect its own confidential information. Before disclosing the Confidential Information to any Representative, the Recipient will inform such Representative of the confidential nature of such information, their duty to treat the Confidential Information in accordance with this Agreement and shall ensure that such Representative is legally bound by the terms and conditions of this Agreement or subject to confidentiality duties or obligations to the Recipient that are no less restrictive than the terms and conditions of this Agreement.

(e) Any provision herein to the contrary notwithstanding, the Companies may disclose Confidential Information to the State of Hawai'i Public Utilities Commission ("Commission")



and/or the State of Hawai'i Division of Consumer Advocacy (including their respective staffs) provided that such disclosure is made under a protective order entered in the docket or proceeding with respect to which the disclosure will be made or any general protective order entered by the Commission.

5. Required Disclosure and Notice

If the parties or any of their Representatives become legally compelled (by deposition, interrogatory, request for documents, subpoena, civil investigative demand, court order, or similar process) to disclose any of the Confidential Information, the compelled party shall undertake reasonable efforts to provide the other party with notice within three (3) business days of such requirement or advice prior to disclosure so that the other party may (a) seek a protective order or other appropriate remedy, (b) consult with the other party with respect to the compelled party taking steps to resist or narrow the scope of such requirement or advice, and/or (c) waive compliance, in whole or in part, with the terms of this Agreement. If such protective order or other remedy is not obtained, or the other party waives compliance with the provisions hereof, the compelled party agrees to furnish only that portion of the Confidential Information which it is legally required to so furnish and, at the request of the other party, to use reasonable efforts to obtain assurance that confidential treatment will be accorded such Confidential Information, it being understood that such reasonable efforts shall be at the cost and expense of the party whose Confidential Information has been sought. In any event, neither the IPP nor any of its Representatives will oppose action by the Companies to obtain an appropriate protective order or other reliable assurance that confidential treatment will be accorded the Confidential Information.

6. Return or Destruction of Confidential Information

At any time during or after the term of this Agreement, at the Provider's written request, and in any event, upon the termination of the Agreement, the Recipient shall certify within ten (10) business days that it has destroyed all Confidential Information by using industry standard data elimination methods used to prevent unauthorized disclosure of information, and for Personally Identifiable Information (defined as personally identifiable information of individuals, and any information that may be used to track, locate or identify such individuals (or which is otherwise protected by privacy laws), including any automatically generated information (such as IP addresses and other customer identifiers) that identifies or is unique or traceable to a particular individual or computer or other electronic device capable of accessing the internet, including without limitation, name, address, telephone number, social security number, credit card account numbers, email addresses, user identification numbers or names and passwords, which is disclosed to the Recipient or its subcontractors in connection with this Agreement by the Provider, which products and services are used or intended to be used for personal, family or household purposes), such methods shall be consistent with Hawaii Revised Statutes Chapter 487-R; provided, however, that with respect to Confidential information in tangible form, the Recipient may return such Confidential Information to the Provider within ten (10) business days in lieu of destruction. The Recipient's sole obligation with respect to the disposition of any Notes shall be to redact or otherwise expunge all such Confidential Information from such Notes and certify to the Provider that it has so redacted or expunged the Confidential Information. Notwithstanding the foregoing, with respect to any Confidential Information stored in Recipient's disaster recovery backups or

other electronic archives, Recipient is not required to destroy such Confidential Information if it would impose a material cost or burden; provided, however, such Confidential Information shall be destroyed when such archives are destroyed in accordance with Recipient's records retention policies.

7. Authority

Each party represents and warrants that it has full power and authority to enter into and perform this Agreement, and the person signing this Agreement on behalf of each has been properly authorized and empowered to enter into this Agreement, understands it and agrees to be bound by it.

8. No Representations or Warranties

Neither the Provider nor any of its Representatives make any express or implied representation or warranty as to the accuracy or completeness of any Confidential Information disclosed to the Recipient hereunder, and the Recipient agrees that it is not entitled to rely on the accuracy or completeness of any Confidential Information. Neither the Provider nor any of its Representatives shall be liable to the Recipient or any of its Representatives relating to or arising from the use of any Confidential Information or for any errors therein or omissions therefrom. Notwithstanding the foregoing, the Recipient shall be entitled to rely solely on such representations and warranties regarding Confidential Information as may be made to it in any final agreement relating to the Project, subject to the terms and conditions of such agreement.

9. No Other Obligations

Neither this Agreement nor the disclosure of the Confidential Information shall result in any obligation on the part of either party to enter into any further agreement with the other with respect to the subject matter hereof or otherwise, to purchase any products or services from the other, or to require either party to disclose any further information to the other. Nothing in this Agreement shall be deemed to constitute either party hereto as partner, agent or representative of the other party or to create any fiduciary relationship between the parties. Either party may offer products or services which are competitive with products or services now offered or which may be offered by the other. Subject to the express terms and conditions of this Agreement, neither this Agreement nor discussions and/or communications between the parties will impair the right of either party to develop, make, use, procure, and/or market any products or services, alone or with others, now or in the future, including those which may be competitive with those offered by the other. Whether or not the Project is consummated, neither party shall issue a press release or release any information to the general public concerning such transaction or the absence thereof without the express prior written consent of the other, and the parties agree that neither party will use the other's name whether by including reference to the other in any press release, list of customers advertising that its services are used by Companies or otherwise, without written authorization by the respective party's authorized representative.

10. Property Rights in Confidential Information

All Confidential Information shall remain the sole and exclusive property of the Provider and nothing in this Agreement, or any course of conduct between the parties shall be deemed to grant to the Recipient any license or rights in or to the Confidential Information of the Provider, or any part thereof. Unless otherwise expressly agreed in a separate license agreement, the disclosure of Confidential Information to the Recipient will not be deemed to constitute a grant, by implication or otherwise, of a right or license to the Confidential Information or to any patents or patent applications of the Provider.

11. Publicly Traded

The IPP acknowledges that the Companies' holding company is a publicly traded company, and that Confidential Information of the Companies may constitute material, non-public information with respect to the Companies. The IPP understands, and will advise its Representatives to whom Confidential Information of the Companies is disclosed, of the restrictions imposed by the United States securities laws on (a) the purchase or sale of securities by any person in possession of material, non-public information with respect to such securities, and (b) the communication of material, non-public information with respect to securities to a person who may purchase or sell such securities in reliance upon such information.

12. Remedies

(a) Each party acknowledges and agrees that any breach or threatened breach of this Agreement may give rise to an irreparable injury to the Provider or its Representatives, for which compensation in damages is likely to be an inadequate remedy. Accordingly, in the event of any breach or threatened breach of this Agreement by the Recipient or its Representatives, the Provider shall be entitled to seek equitable relief, including in the form of injunctions and orders for specific performance, in addition to all other remedies available at law or in equity.

(b) In the event that the Recipient learns of dissemination, disclosure, or use of the Confidential Information which is not permitted by this Agreement, the Recipient shall notify the Provider immediately in writing and shall use reasonable efforts to assist the Provider in minimizing damages from such disclosure. Such remedy shall be in addition to and not in lieu of any other rights or remedies available to the Provider at law or in equity.

13. Cumulative Remedies

No rights or remedy herein conferred upon or reserved to either party hereunder is intended to be exclusive of any other right or remedy, and each and every right and remedy shall be cumulative and in addition to any other right or remedy under this Agreement, or under applicable law, whether now or hereafter existing.

14. Notice

(a) By delivering written notice, either party may notify the other that it no longer wishes to receive or provide Confidential Information. Any further information received or

provided by the party who received such notice following receipt of such notice, shall not be subject to the protection of this Agreement.

(b) All notices, consents and waivers under this Agreement shall be in writing and will be deemed to have been duly given when (i) delivered by hand, (ii) sent by electronic mail (“E-mail”) (provided receipt thereof is confirmed via E-mail or in writing by recipient), (iii) sent by certified mail, return receipt requested, or (iv) when received by the addressee, if sent by a nationally recognized overnight delivery service (receipt requested), in each case to the appropriate addresses and E-mail Addresses set forth below (or to such other addresses and E-mail addresses as a party may designate by notice to the other party):

**(1) Companies:**

By Mail:

Hawaiian Electric Company, Inc.  
P.O. Box 2750  
Honolulu, Hawaii 96840  
Attn: Manager of Procurement, Renewable Acquisition Division

Delivered By Hand or Overnight Delivery:

Hawaiian Electric Company, Inc.  
Central Pacific Plaza  
220 South King St, 21<sup>st</sup> Floor  
Honolulu, HI 96813  
Attn: Manager of Procurement, Renewable Acquisition Division

By E-mail:

Hawaiian Electric Company, Inc.  
Attn: Manager of Procurement, Renewable Acquisition Division  
Email: [renewableacquisition@hawaiianelectric.com](mailto:renewableacquisition@hawaiianelectric.com)

With a copy to:

By Mail:

Hawaiian Electric Company, Inc.  
Legal Department  
P.O. Box 2750  
Honolulu, Hawaii 96840

Delivered By Hand or Overnight Delivery:

Hawaiian Electric Company, Inc.  
American Savings Bank Tower  
1001 Bishop Street, Suite 1100  
Honolulu, Hawaii 96813  
Attn: Legal Department

By E-mail:

Hawaiian Electric Company, Inc.  
Legal Department  
Email: [legalnotices@hawaiianelectric.com](mailto:legalnotices@hawaiianelectric.com)

**(2) [IPP]**

By Mail:

[INSERT ADDRESS/CONTACT]

Delivered By Hand or Overnight Delivery:

[INSERT ADDRESS/CONTACT]

By E-mail:

[INSERT ADDRESS/CONTACT]

With a copy to:

By Mail:

[INSERT ADDRESS/CONTACT]

Delivered By Hand or Overnight Delivery:

[INSERT ADDRESS/CONTACT]

By E-mail:

[INSERT ADDRESS/CONTACT]

15. No Waiver

Except as otherwise provided in this Agreement, no delay or forbearance of a party in the exercise of any remedy or right will constitute a waiver thereof, and the exercise or partial exercise of a remedy or right shall not preclude further exercise of the same or any other remedy or right.

16. Governing Law

This Agreement is made under, governed by, construed and enforced in accordance with, the laws of the State of Hawaii. Any action brought with respect to the matters contained in this Agreement shall be brought in the federal or state courts located in the State of Hawaii. Each party agrees and irrevocably consents to the exercise of personal jurisdiction over each of the parties by such courts and waives any right to plead, claim or allege that the State of Hawaii is an inconvenient forum or improper venue.

17. Attorneys' Fees and Costs

If there is a dispute between the parties and either party institutes a lawsuit, arbitration, mediation or other proceeding to enforce, declare, or interpret the terms of this Agreement, then the prevailing party in such proceeding shall be awarded its reasonable attorneys' fees and costs.

18. Assignment Prohibited

This Agreement shall be binding upon and inure to the benefit of the parties hereto and their respective successors, legal representatives, and permitted assigns. Neither party shall have the right to assign any of its rights, duties or obligations under this Agreement, by operation or law or otherwise, without the prior written consent of the other party. Any purported assignment in violation of this section shall be null and void.

19. No Third Party Beneficiaries

Nothing expressed or referred to in this Agreement will be construed to give any person or entity other than the parties any legal or equitable right, remedy, or claim under or with respect to this Agreement or any provision of this Agreement. This Agreement and all of its provisions and conditions are for the sole and exclusive benefit of the parties and their successors and permitted assigns.

20. Entire Agreement

This Agreement constitutes the entire agreement between the parties relating to the subject matter hereof, superseding all prior and contemporaneous agreements, understandings or undertakings, oral or written with respect to the subject matter. Any amendment or modification of this Agreement or any part hereof shall not be valid unless in writing and signed by the Parties. Any waiver hereunder shall not be valid unless in writing and signed via by the party against whom waiver is asserted.

21. Term and Survival

This Agreement shall remain in full force and effect for a period of two (2) years from the Effective Date. All confidentiality obligations within this Agreement shall survive following expiration or termination of this Agreement.

22. Severability

If any term or provision of this Agreement, or the application thereof to any person, entity or circumstances is to any extent invalid or unenforceable, the remainder of this Agreement, or the application of such term or provision to persons, entities or circumstances other than those as to which it is invalid or unenforceable, shall not be affected thereby, and each term and provision of this Agreement shall be valid and enforceable to the fullest extent permitted by law, and the parties will take all commercially reasonable steps, including modification of the Agreement, to preserve the economic "benefit of the bargain" to both parties notwithstanding any such aforesaid invalidity or unenforceability.

23. Negotiated Terms

The parties agree that the terms and conditions of this Agreement are the result of negotiations between the parties and that this Agreement shall not be construed in favor of or against any party by reason of the extent to which any party or its professional advisors participated in the preparation of this Agreement.

24. Counterparts and Electronic Signatures

This Agreement may be executed in counterparts, each of which shall be deemed an original, and all of which shall together constitute one and the same instrument binding all parties notwithstanding that all of the parties are not signatories to the same counterparts. For all purposes, duplicate unexecuted and unacknowledged pages of the counterparts may be discarded and the remaining pages assembled as one document. The parties agree that this Agreement and any subsequent writings, including amendments, may be executed and delivered by exchange of executed copies via E-mail or other acceptable electronic means, and in electronic formats such as Adobe PDF or other formats mutually agreeable to the parties which preserve the final terms of this Agreement or such writing. A party's signature transmitted by E-mail or other acceptable electronic means shall be considered an "original" signature which is binding and effective for all purposes of this Agreement.

*[Signature Page Follows]*

IN WITNESS WHEREOF, each party has caused this Agreement to be executed on its behalf by a duly authorized representative, all as of the Effective Date.

HAWAIIAN ELECTRIC COMPANY, INC.

By: \_\_\_\_\_  
Print Name: \_\_\_\_\_  
Its: \_\_\_\_\_

MAUI ELECTRIC COMPANY, LIMITED

By: \_\_\_\_\_  
Print Name: \_\_\_\_\_  
Its: \_\_\_\_\_

HAWAII ELECTRIC LIGHT COMPANY, INC,

By: \_\_\_\_\_  
Print Name: \_\_\_\_\_  
Its: \_\_\_\_\_

“Companies”

[Insert Name of IPP]

\_\_\_\_\_  
By: \_\_\_\_\_  
Print Name: \_\_\_\_\_  
Its: \_\_\_\_\_

“IPP”



**DRAFT**  
**REQUEST FOR PROPOSALS**  
**FOR**  
**NORTH KOHALA**  
**ENERGY STORAGE**  
**ISLAND OF HAWAI‘I**

OCTOBER 29, 2021

Docket No. TBD

*Appendix F – Description of the Site*



**Hawai'i  
Electric  
Light**

**HAWAIIAN ELECTRIC COMPANIES  
NORTH KOHALA ENERGY STORAGE  
DESCRIPTION OF THE SITE**

**Akoni Pule Site**

All proposals submitted in response to this RFP must be sited at the Akoni Pule Site. It is a Company Controlled Site consisting of 1.207 acres located along Akoni Pule Highway in Hawi Village, North Kohala (a portion of TMK (3)5-5-002: 023). See Exhibit A to this Appendix F. The site is zoned Agricultural.

The Company Controlled Site is currently vacant land that is privately owned. The Company has a perpetual Grant of Easement from the private landowner for the Akoni Pule Site. The Akoni Pule Site adjoins the existing Company-owned Hawi Substation (TMK (3)5-5-015: 033). The Akoni Pule Site, which is approximately 1.207 acres, has been allocated for this project, with the boundaries for the site being approximately 182.65 ft at its widest (on the front running parallel to Akoni Pule Highway), and approximately 274.84 feet deep (toward the interior of the property, away from Akoni Pule Highway). Proposer shall only be permitted to lease as much acreage as is necessary for its project. Additional acreage shall not be available and Proposers may only use the available land for its project and for no other uses. The current plan anticipates that the Akoni Pule Site will be purchased by the Company then will be consolidated with the adjoining Company-owned Hawi Substation. Any Proposer proposing to use the Akoni Pule Site shall be required to execute a ground lease for the site coterminous with the term of the ESSA. Proposer shall be responsible, at its sole cost and expense, for all other site improvements, utilities, permits and other required infrastructure and regulatory requirements necessary for use of the Akoni Pule Site for Proposer's Project.

Any drawings, reports or any other information or data relating to the Akoni Pule Site ("Site Information") are being furnished for the Proposer's convenience only and the Company assumes no responsibility whatsoever in respect to the sufficiency or accuracy of such Site Information or of the interpretation thereof, and there is no guaranty, either expressed or implied, that the conditions indicated are representative of those existing throughout the Akoni Pule Site. In addition, no assurance is given that conditions found at the time of any surface or subsurface explorations will be the conditions that prevail at the time of construction at the Akoni Pule Site. The Proposer shall be solely responsible for all assumptions, deductions, or conclusions the Proposer may make or derive from the information furnished. Making such information available to the Proposer is not to be construed in any way as a waiver of the Proposer's responsibility to examine the Request for Proposals and the Akoni Pule Site. Proposer must satisfy itself through its own investigation as to conditions to be encountered at the Akoni Pule Site.

All underground water, gas, oil, telephone, electric, storm drain, sewer, and other pipes or conduits that may be shown on the Site Information are only approximate in their locations. The Proposer shall make a personal investigation and inspection of the records and drawings possessed by owners of the utilities. The Proposer shall make satisfactory arrangements with the owners of the utilities for the relocation, maintenance and protection of existing utilities, if any.

### **Additional Information**

Additionally, the following links to a few publicly available resources relating to renewable energy project siting and development from the Hawai'i State Energy Office are being provided for use at proposers' sole discretion:

### **Project Permitting Assistance and Resources**

<http://energy.hawaii.gov/developer-investor/project-permitting-assistance-and-resources>

Provides numerous resources to support more informed and appropriate project siting and permitting, including the Permit Guide, Renewable Energy Permitting Consultants, DOH, ePermitting Portal, Renewable EnerGIS, Permitting Wizard, and the Renewable Energy Projects Directory.

### **Hawai'i Clean Energy Programmatic Environmental Impact Statement**

<http://energy.hawaii.gov/testbeds-initiatives/hawaii-clean-energy-peis/peis-overview>

The Hawaii Clean Energy Programmatic Environmental Impact Statement (PEIS) analyzes, at a programmatic level, the potential environmental impacts of clean energy activities and technologies in the following clean energy categories: (1) Energy Efficiency, (2) Distributed Renewables, (3) Utility-Scale Renewables, (4) Alternative Transportation Fuels and Modes, and (5) Electrical Transmission and Distribution.

### **Hawai'i Statewide GIS Program**

<http://planning.hawaii.gov/gis/>

Provides Hawai'i GIS data and other resources to support site identification and analysis.

**Aloha Aina: A Framework for Biocultural Resource Management in Hawai‘i’s  
Anthropogenic Ecosystems**

[https://nmshawaiihumpbackwhale.blob.core.windows.net/hawaiihumpbackwhale-prod/media/archive/council/pdfs/aloha\\_aina.pdf](https://nmshawaiihumpbackwhale.blob.core.windows.net/hawaiihumpbackwhale-prod/media/archive/council/pdfs/aloha_aina.pdf)

A framework developed by the Hawaiian Islands Humpback Whale National Marine Sanctuary Advisory Council to integrate Native Hawaiian and Western scientific management approaches toward ecosystem management. While intended for the Sanctuary, this document provides useful insight into successful collaboration in Hawai‘i.



**DRAFT**  
**REQUEST FOR PROPOSALS**  
**FOR**  
**NORTH KOHALA**  
**ENERGY STORAGE**  
**ISLAND OF HAWAI‘I**

OCTOBER 29, 2021

Docket No. TBD

*Appendix G – Hawaiian Electric Proposal Team  
Certification Form*



**Hawai‘i  
Electric  
Light**

## Appendix G - Hawaiian Electric Proposal Team Option

### Overview

To the extent that there are Hawaiian Electric Proposals to the RFP, the Company will endeavor to evaluate these Hawaiian Electric Proposals on a fair basis compared to third party Proposals. As described in Section 1.9.1 of the RFP, “[t]he Competitive Bidding Framework allows the Company the option to offer a Proposal(s) in response to this RFP (“Hawaiian Electric Proposal”). Accordingly, the Company must follow certain requirements and procedures designed to safeguard against and address concerns associated with: (1) preferential treatment of the Hawaiian Electric Proposal or members, agents or consultants of the Company formulating the Hawaiian Electric Proposal; and (2) preferential access to proprietary information of the Hawaiian Electric Proposal Team.” Any Proposal from the Hawaiian Electric Proposal Team will be required to comply with the provisions in the Framework for Competitive Bidding (“Framework”) as well as this RFP.

In addition to its Proposal, the Hawaiian Electric Proposal Team will be required to submit Attachment 1 to this Appendix G, Hawaiian Electric Proposal Team Certification Form, acknowledging it has followed the rules and requirements of the RFP to the best of its ability and has not engaged in any collusive actions or received any preferential treatment or information providing an impermissible competitive advantage to the Hawaiian Electric Proposal Team over other proposers responding to this RFP, as well as adherence to ESSA terms and milestones required of all proposers and the Hawaiian Electric Proposal’s proposed cost protection measures.

Pursuant to the Framework and as set forth in the RFP Schedule, the Company will require that the Hawaiian Electric Proposal be submitted electronically through the Electronic Procurement Platform a minimum of one (1) Day before other Proposals are due.

Except where specifically noted, a Hawaiian Electric Proposal must adhere to the same price and non-price Proposal requirements as required of all Proposers.

As described in Section 3.8.4 of the RFP, if selected, a Hawaiian Electric Proposer will not be required to enter into an ESSA with the Company. However, the Hawaiian Electric Proposal will be held to the same performance metrics and milestones set forth in the ESSA to the same extent as all Proposers, as attested to in the Hawaiian Electric Proposal’s Appendix G Attachment 1 Hawaiian Electric Proposal Team Certification submittal. If liquidated damages are assessed, they will be paid from shareholder funds and returned to customers through the Purchased Power Adjustment Clause (“PPAC”),

In lieu of price components, the Hawaiian Electric Proposal will need to provide its total project capital costs, any associated annual O&M costs, as well as annual revenue requirements by year see Appendix B Section 2.0). The Hawaiian Electric Proposal shall submit revenue requirement worksheets with their Proposal that support their annual revenue requirements estimates. A starter revenue requirements template file can be requested by the Hawaiian Electric Proposal Team via email to the RFP Email Address or through the PowerAdvocate Messaging function once the RFP

event opens. The revenue requirements worksheets submitted will be customized to reflect the details of the Project's Proposal. All assumptions used will be reflected in an assumptions input tab.

### **Hawaiian Electric Proposal Total Project Capital Cost**

The following is a high-level breakdown followed by a narrative explanation of the total capital cost estimate for a potential Hawaiian Electric Proposal. The total project capital cost (and annual O&M costs) will be used to calculate the Revenue Requirement, which will then be used to calculate a LB for Proposal comparison purposes. The categories of costs include:

- Facility
  - EPC Contract
  - Allowance for Change Orders
  - Equipment
  - Owner's Cost
- Outside Services
- Interconnection
- Overheads
- AFUDC

These costs will be identified in Section 2.3.2.2 of the Hawaiian Electric Proposal see [Appendix B Section 2.3.2.2](#)).

- Facility (including any generation and storage components) - This line item, to the extent applicable, should include costs such as:

#### Engineering, Procurement, and Construction ("EPC") Contract

The total cost estimate of the facility is the projected EPC contract cost including the design of the facility up to the high-voltage terminals of the step-up transformers, procurement of all the equipment, and services necessary to build the facility and construction and commissioning of the facility.

#### Allowance for Change Orders

This allocation accounts for items such as additional requirements resulting from unforeseen conditions, unexpected permitting requirements, force majeure events, unanticipated interferences, different interpretations of design requirements, material unavailability, and longer than normal delivery times.

#### Equipment

This cost includes the generator and the facility equipment that support the operation of the generator and the distribution of electrical power around the station, as applicable. Engineering and testing services required to ensure that the equipment is properly functioning at the site, training and documentation necessary to operate and maintain the equipment, and performance guarantees may also be included here.



### Owner's Cost

Owner's costs for the facility are all the costs necessary for the design, permitting, procurement, construction, and commissioning of the facility and for the preparation of the Proposal that are not included in the major contracts (i.e. EPC). The Companies' Labor includes Project Management, Station Operator training and commissioning, Environmental, Safety, Legal, Corporate Communications, Community and Government Relations, Engineering, and Regulatory Affairs. Company Labor for the preparation of the Proposal is also included here. For purposes of recovery, only the incremental costs of Labor will be subject to separate recovery.

- Outside Services - This line item, to the extent applicable, should include costs such as:
  - Construction Management to oversee the EPC contractor
  - Legal for the preparation of the Environmental Impact Statement and PUC process
  - Engineering for development and evaluation of the project technical specifications, Interconnection Requirements Study (IRS), and emissions testing
  - Environmental to conduct the Environmental Impact Statement (EIS) and Air Permit consulting
  - General Services such as surveys, land appraisals, Environmental Condition Reports, public relations, office trailer rental, archeological services, landscaping, miscellaneous permits, builder's risk insurance, switchgear testing, hazard analysis, painting, monitoring services, and moving costs.
  - Material costs including spare parts, furnishings, IT equipment, appliances, generator system initial fills (fuels, oils, water), and telecommunications equipment for the station.
  - Travel costs required to inspect other similar facilities, observe final acceptance testing of critical equipment, and station operators' factory training
- Interconnection – This line item covers all interconnection costs that a similarly situated IPP would be responsible for as described in RFP Section 2.3.5, and to the extent applicable, should include costs such as:

### Distribution Line

The cost estimate includes the design, procurement, and construction of any new distribution infrastructure needed to interconnect with the designated substation.

### Switchyard

Work at the switchyard will include design, procurement, and construction of the switchyard and the interfaces between the high voltage terminals of the generator step-up transformers and the circuit to which it will be connected. Site preparation

of the switchyard and the design, procurement, and installation of the step-up transformers located in the switchyard, are typically included in the EPC contract.

#### Substation

Work at the designated substation that will include the design, procurement, and construction of the interfaces between the new distribution line and the substation buswork to which it will be connected.

#### Telecom

Accounts for direct labor, materials, and outside services to install telecommunication requirements for the project.

#### Project Management

Cost estimate of the project management design, procurement, contracting, and scheduling efforts for the interconnection only. Project management costs for the facility are included in the Owner's Cost estimate above.

- Overhead Costs

Overhead costs for the proposed facility will be estimated by the Company's budgeting software (UI Planner) and represent an allocation for those Company costs that are not attributable to any particular project or operation, but are essential nonetheless. Overheads are comprised of non-productive wages (such as holiday, sick, and vacation pay), employee benefits, payroll taxes, corporate administrative costs, and clearing costs.

- Allowance for Funds Used During Construction ("AFUDC")

The AFUDC will be calculated using the Company's budgeting software (UI Planner) and represents the cost of capital funding for the Project. The Company strives to minimize the cost of the AFUDC by ensuring that Project elements that are used or useful are placed in service as soon as possible, as well as minimizing the amount of time that AFUDC can accumulate, by minimizing the amount of time between expenditures on Project elements and their placement in service.

The Hawaiian Electric Proposal will include a Revenue Requirement for each year, which is calculated from the total project capital cost to determine the revenues needed to recover the cost of the project. The value of the Revenue Requirement Calculation for the Total Hawaiian Electric Proposal Project Capital Cost will be included in the Levelized Benefit calculation described below.

### **Annual O&M**

The cost for ongoing O&M (fixed and variable) will be a component of the Revenue Requirement. All O&M should be included in this category, unless captured elsewhere in the Revenue Requirement Calculation, including but not limited to annual O&M expense to maintain facility; property taxes (if applicable), and insurance. As described in RFP Appendix G, a Hawaiian Electric Proposal will be required to cap its O&M costs at the amount included in the Proposal.

Only actual costs will be recovered if such actual costs are lower than the maximum amounts in the Proposal.

### **Annual Revenue Requirement**

The Hawaiian Electric Proposal will include a Revenue Requirement for each year, which is calculated from the total project capital cost to determine the revenues needed to recover the cost of the project. The value of the Revenue Requirement Calculation for the Total Hawaiian Electric Project Capital Cost will be included in the Levelized Benefit calculation.

The following is a narrative description of the proposed revenue requirement calculation and significant assumptions that the Hawaiian Electric Proposal should account for. The objective of a revenue requirement analysis is to illustrate the annual revenue requirements (ARR) for a Hawaiian Electric Proposal.

Revenue Requirement is defined as a calculated value which represents the estimated revenues needed from ratepayers which would allow the Company to recover its capital investment and expenses, honor its debt obligations, pay its revenue and income tax liabilities, and pay its preferred shareholders while providing a fair return to its common shareholders for their investment. Specific factors or assumptions related to that particular project will be included in the analysis.

The purpose of a revenue requirement calculation is to determine the annual and total revenue requirements of a capital investment and annual O&M expense needed from customers. The ratemaking formula for revenue requirements is shown below.

$$RR = O + T + D + r(RB)$$

Where:      RR = Revenue Requirements  
              O = Operating and Maintenance Expense  
              T = Tax Expense (Income and Revenue)  
              D = Depreciation Expense  
              r = Rate of Return on Rate Base  
              RB = Rate Base

The Company, in conjunction with the Independent Observer, may also conduct a risk assessment of the Hawaiian Electric Proposal to ensure an appropriate level of customer cost protection measures are included in such proposal.

**APPENDIX G ATTACHMENT 1 - HAWAIIAN ELECTRIC PROPOSAL TEAM CERTIFICATION**

**Name of Hawaiian Electric  
Proposal Team Contact:**

\_\_\_\_\_

**Unique Name of Facility:**

\_\_\_\_\_

This Certification of the Hawaiian Electric Proposal Team's Proposal for Hawaiian Electric Company, Inc.'s ("Company, Maui Electric Company, Ltd., and Hawai'i Electric Light Company, Inc.'s (the "Hawaiian Electric Companies")) Request for Proposals for Community-Based Renewable Energy Projects (RFP) is made as of the date stated below.

**A. COMPLIANCE WITH THE RFP AND CODE OF CONDUCT**

The Hawaiian Electric Proposal Team certifies and acknowledges that it will/has:

1. Adhered to the terms of the RFP applicable to the Hawaiian Electric Proposal Team, including but not limited to: Section 1.7.1 (proposal submittal requirements) , Section 1.7.4 (certification of non-collusion), Section 1.9 (Procedures for any Hawaiian Electric or Affiliate Proposals), and Section 3.4.4 (authorized signatory);
2. Adhered to the technical requirements of the RFP, excluding however those requirements inapplicable to the Hawaiian Electric Proposal Team such as execution of the Model ESSA, pricing formula requirements for independent power producer proposals, submission of a Proposal Fee, dispute resolution, credit requirements, selection of a priority list, and submission of a best and final offer;
3. Complied with the Company's Code of Conduct Procedures Manual, attached as Appendix C to this RFP, with particular attention to the Communications Protocols described in Section C therein with respect to communication with the Company RFP Team.

**B. INDEPENDENT INVESTIGATION**

The Hawaiian Electric Proposal Team further certifies and acknowledges that it will/has:

1. Submitted the Hawaiian Electric Proposal based on its own investigations, examinations, and determinations, including assessments of any risks that could have an effect on its obligations under the Hawaiian Electric Proposal.
2. Carefully examined the Company's RFP documents and its appendices and has a clear and comprehensive knowledge of what is required of a Proposer under the RFP, and correspondingly, what is required of the Hawaiian Electric Proposal Team.

3. Examined and understands the technical requirements, schedule, and evaluation process as it is laid out in the RFP.

**C. COST PROPOSAL ACKNOWLEDGEMENTS**

The Hawaiian Electric Proposal Team acknowledges and agrees that:

1. Recovery for Project capital costs and O&M costs will be capped at the amount included in the Hawaiian Electric Proposal Team's Proposal.
2. Only actual capital costs and O&M costs will be recovered even if such actual costs are lower than the Hawaiian Electric Proposal Team's proposed maximum amounts.
3. Costs of developing the proposal must be included in the Hawaiian Electric Proposal for evaluation purposes only. Only the incremental costs of developing the Hawaiian Electric Proposal Team's proposal will be charged to the project and passed through to customers. Incremental costs for the Hawaiian Electric Proposal not serving as the Parallel Plan and which are not selected to the Final Award Group will not be recoverable from the Companies' customers.

**D. ADHERENCE TO ESSA REQUIREMENTS AND MILESTONES**

The Hawaiian Electric Proposal Team acknowledges and agrees that:

1. The Hawaiian Electric Proposal will be consistent with the scope of work and responsibilities of the "Seller" under the terms of the Model ESSA excluding inapplicable terms related to commercial and legal interactions between the Seller and the Company.
2. The Hawaiian Electric Proposal Facility will be designed and constructed to:
  - a. Achieve the Performance Standards identified in Section 3 - Performance Standards, in Attachment B of the Model ESSA as modified by the IRS (subject to reasonable adjustment agreeable to the Company consistent with the Company's negotiation of such performance standards that would be completed with an independent power producer under similar circumstances);
  - b. Meet the following performance metrics as specified in Article 4 of the Model ESSA: (i) Performance Level Rated Energy Capacity, (ii) Performance Level Availability, and (iii) Performance Level Round Trip Efficiency;
  - c. Pass the Acceptance Test specified in Attachment N – Acceptance Test General Criteria of the Model ESSA.
  - d. Pass the Control System Performance Test specified in Attachment O – Control System Acceptance Test Criteria of the Model ESSA;

- e. Meet the project milestones identified in the Hawaiian Electric Proposal no later than the dates specified therein, which shall be consistent with the guaranteed project milestones required in Attachment K – Guaranteed Project Milestones of the Model ESSA (subject to reasonable adjustment agreeable to the Company consistent with the Company’s negotiation of such milestones that would be completed with an independent power producer under similar circumstances). Notice of completion of milestones and any delay will be provided to PUC and Consumer Advocate.
- f. Achieve the reporting milestones identified in the Hawaiian Electric Proposal no later than the dates specified therein, which shall be consistent with the reporting milestones required in Attachment L – Reporting Milestones of the Model ESSA (subject to reasonable adjustment agreeable to the Company consistent with the Company’s negotiation of such milestones that would be completed with an independent power producer under similar circumstances). Notice of completion of milestones and any delay will be provided to PUC and Consumer Advocate.
- g. Will be subject to the applicable liquidated damages for the Model ESSA provisions above. These liquidated damages would be paid from shareholder funds and would be passed through to customers through the Companies’ Power Purchase Adjustment Clause. Notice of any liquidated damages assessed and amounts of such liquidated damages will be provided to PUC and Consumer Advocate.
- h. Will reconfirm requirements in GO7 application and any resulting approval order for such application.
- i. Will provide annual report to PUC and Consumer Advocate on performance metrics.

**E. DECLARATION AND SIGNATURE**

- 1. The individual(s) that has (have) signed this Hawaiian Electric Proposal Team Certification is (are) duly authorized by the Hawaiian Electric Proposal Team to execute such on behalf of the Hawaiian Electric Proposal Team; and
- 2. All statements, specifications, data, confirmations, and other information set out in this Hawaiian Electric Proposal Team Certification are complete and accurate in all material respects.

IN WITNESS WHEREOF, the HAWAIIAN ELECTRIC PROPOSAL TEAM hereby makes the certifications, acknowledgements, and agreements stated herein as of the date stated under the signature of its authorized representative:

Dated at \_\_\_\_\_, \_\_\_\_\_ this \_\_\_\_\_ day of \_\_\_\_\_ 20\_\_\_\_\_.

Representative

\_\_\_\_\_  
Signature of Hawaiian Electric Proposal Team

(please print)

\_\_\_\_\_  
Name of Hawaiian Electric Proposal Team Representative

(please print)

\_\_\_\_\_  
Title of Hawaiian Electric Proposal Team Representative

**DRAFT**  
**REQUEST FOR PROPOSALS**  
**FOR**  
**NORTH KOHALA**  
**ENERGY STORAGE**  
**ISLAND OF HAWAI‘I**

OCTOBER 29, 2021

Docket No. TBD

*Appendix H – Interconnection Facilities Cost and  
Schedule Information*



**Hawai‘i  
Electric  
Light**



Hawaiian Electric Company  
Interconnection Facilities Cost and Schedule Information

**TABLE OF CONTENTS**

Section 1 – Cost Responsibilities..... 1

    1.1 – Definitions..... 1

    1.2 – Abbreviations..... 1

    1.3 – Facilities At Proposer Site ..... 2

    1.4 – [Not Used]..... 2

    1.5 – Remote Substation Facilities..... 2

    1.6 – Line Extension from Grid Connection Point (GCP) To Proposer Site..... 3

    1.7 – T&D System Upgrades..... 3

    1.8 – Company-Owned Fiber..... 3

    1.9 – Telecommunication Facilities ..... 4

    1.10 – Control System Acceptance Test (CSAT) ..... 4

Section 2 – Interconnection Requirements ..... 4

    2.1 – COIF Requirements ..... 4

    2.2 – Telecommunication Requirements ..... 5

    2.3 – Typical Security Requirements..... 5

        A. Proposer Responsibilities at Proposer Facility ..... 5

Section 3 – Typical Company Durations for Interconnection Projects ..... 5

Hawaiian Electric Company  
Company-Owned Interconnection Facilities Cost and Schedule Information

The information provided in this document can be used to assist Proposers in estimating costs and schedule of potential projects.

## **SECTION 1 – COST RESPONSIBILITIES**

For the purposes of this RFP, the Company will be responsible for the costs of Company-Owned Interconnection Facilities (COIF), subject to any limitations, as described in Section 1. The Company will not be responsible for any costs related to work deemed excessive and/or corrective in nature. The information below will help to clarify the responsibilities of the Company and the Proposer for COIF.

### **1.1 – DEFINITIONS**

1. Betterment – Any upgrading to a facility made solely for the benefit of and at the election of the Company and is not required by applicable laws, codes, Company Standards, and the interconnection requirements in accordance with Tariff Rule No. 19.
2. Company –Hawai'i Electric Light.
3. Company-Owned Interconnection Facilities – The equipment and devices owned by Company that are required to permit an energy storage facility to operate in parallel with and deliver electric energy to Company's system and provide reliable and safe operation of, and power quality on, Company's system.
4. Grid Connection Point – The point that the new interconnection facilities associated with the Proposer's project interconnects to the Company's existing electrical grid.
5. Interconnection Agreement – The executed contract between the Company and Proposer (e.g., Power Purchase Agreement, Standard Interconnection Agreement, etc.).
6. Point of Interconnection – The point of delivery of energy supplied by Proposer to Company, where the Facility owned by the Proposer interconnects with the facilities owned or to be owned by the Company.
7. Proposer – The developer proposing an energy storage project in response to a Company RFP.

### **1.2 – ABBREVIATIONS**

1. ADSS – All Dielectric Self-Supporting
2. BESS – Battery Energy Storage System
3. COIF – Company-Owned Interconnection Facilities
4. CSAT – Control System Acceptance Test
5. CT – Current Transformer
6. DFR – Digital Fault Recorder
7. DTT – Direct Transfer Trip
8. FS – Facility Study
9. GCP – Grid Connection Point
10. HVAC – Heating, Ventilation, and Air Conditioning
11. IRS – Interconnection Requirements Study (includes both SIS and FS)

Hawaiian Electric Company  
Company-Owned Interconnection Facilities Cost and Schedule Information

12. NDA – Non-Disclosure Agreement
13. OPGW- Optical Ground Wire
14. POI – Point of Interconnection
15. PT – Potential Transformer
16. RTU – Remote Terminal Unit
17. SCADA – Supervisory Control and Data Acquisition
18. SIS – System Impact Study
19. UFLS – Under-Frequency Load Shed

### 1.3 – FACILITIES AT PROPOSER SITE

1. Proposer shall be responsible for obtaining all permitting and any land rights required that are not provided by Company.
2. Except for costs agreed to be paid by Company under Item 3 below, Proposer shall be responsible for the design, procurement, and construction of all facilities at the BESS site. This may include, but is not limited to:
  - a. Civil infrastructure and site work (grading, trenching, manholes/handholes, conduits, cable trench, concrete pads/foundations, fencing, roadways/driveways, ground grid, lighting, etc.)
  - b. Communications cabinets and infrastructure (poles/towers for antenna/microwave dish, equipment pads, conduits, foundations, HHs, AC power, grounding, etc.)
  - c. Security systems/equipment
  - d. T&D infrastructure drawings showing the route of OH and UG lines and equipment locations at the project site
    - i. Any UG conduits for a T&D line extension that need to extend off the property should stubout at the property line for the Company to connect to
3. Company shall be responsible for costs related to the design, procurement, construction, and testing of electrical COIF at the project site. This may include, but is not limited to:
  - a. Equipment (circuit breakers, transformers, relays, switches, arresters, batteries, HVAC, RTU, DFR, DTT, meters, PTs, CTs, etc.)
  - b. Pre-wired control equipment enclosure/cabinet
  - c. Communications equipment
  - d. Electrical work (bussing, wiring, lightning protection, fiber optic cable, etc.)

### 1.4 – [NOT USED]

### 1.5 – REMOTE SUBSTATION FACILITIES

1. Company shall be responsible for all costs. This may include, but is not limited to:
  - a. Betterment
  - b. System upgrades, changes, or replacement of existing facilities (e.g., breaker replacements, relay upgrade, transformer installs, Under-Frequency Load Shed (UFLS) settings, etc.)

Hawaiian Electric Company  
Company-Owned Interconnection Facilities Cost and Schedule Information

- c. Site work associated with those system upgrades (grading, trenching, manholes/handholes, conduits, cable trench, concrete pads/foundations, fencing, roadways/driveways, ground grid, lighting, etc.)
- d. Substation structures
- e. New control equipment cabinet or existing enclosure expansion
- f. Equipment (circuit breakers, transformers, relays, switches, arresters, batteries, HVAC, DFR, DTT, meters, PTs, CTs, SCADA equipment, telecommunications routers, etc.)
- g. Electrical work (bussing, wiring, lightning protection, fiber optic cable, etc.)
- h. Telecommunications equipment

**1.6 – LINE EXTENSION FROM GRID CONNECTION POINT (GCP) TO PROPOSER SITE**

1. Company shall be responsible for the design, procurement, and construction of the line extension between the GCP and the Proposer site. This may include, but is not limited to:
  - a. Overhead electrical facilities (poles, conductor, insulators, crossarms, guy wires, etc.)
  - b. Underground electrical facilities (cables, splices, terminations, grounding, transformers, switchgears, etc.)
  - c. Civil/structural work (design, survey, grading, trenching, conduits, manholes/handholes, concrete pads, concrete pier foundations, pole hole excavation, etc.)
  - d. Vegetation trimming and traffic control
  - e. Betterment
2. Proposer shall be responsible for obtaining all permitting and land rights.

**1.7 – T&D SYSTEM UPGRADES**

1. Company shall be responsible for all costs related to system upgrades or changes required to accommodate the Proposer's project (e.g., re-conductoring or recircuiting of existing lines that do not have the required ampacity, re-fusing or re-programming of protective devices upstream of the GCP, etc.)

**1.8 – COMPANY-OWNED FIBER**

1. If Company-owned fiber is used to satisfy the communications requirements in the IRS, then the Company shall be responsible for all costs related to the design, procurement, construction, and testing of the ADSS fiber or OPGW from the nearest existing splice point to the Proposer site. This may include, but is not limited to:
  - a. Company fiber-optic cable (ADSS fiber cable or OPGW shieldwire) and associated equipment/hardware (splice boxes, innerduct, vibration dampers, etc.)
  - b. Splicing and Testing of fiber strands
  - c. Pole replacements and additional equipment if needed for additional capacity

Hawaiian Electric Company  
Company-Owned Interconnection Facilities Cost and Schedule Information

- d. Civil/structural work outside of Proposer's project site (design, survey, grading, trenching, conduits, manholes/handholes, concrete pads, concrete pier foundations, pole hole excavation, etc.)
  - e. Vegetation trimming and traffic control
  - f. Betterment
2. Proposer shall be responsible for obtaining all permitting and land rights.

### **1.9 – TELECOMMUNICATION FACILITIES**

1. Company shall be responsible for design, procurement, construction, and testing of Company-owned telecommunication facilities. This may include, but is not limited to:
  - a. Fiber cable to the "meet point" outside of Proposer's facility and termination at Company's nearest point of interconnection.
  - b. Microwave radio or wireless radio equipment at the Proposer's facility and at remote site(s) (e.g., microwave dish/equipment, waveguide, cables, antenna system, etc.).
  - c. Telecommunication service equipment required to provide circuits to support various applications at the Proposer's facility.
2. Proposer shall be responsible for all costs related to the following:
  - a. A telecommunication cabinet required to accommodate the telecommunication equipment at the Proposer's facility.
  - b. Telecommunication power at the Proposer's facility (e.g., battery racks, banks, fuse panels, and associated power system equipment).
  - c. Ordering and installing a 3<sup>rd</sup> party leased service at the site. This may include, but is not limited to the initial cost to establish leased line(s) required for the project, monthly recurring leased cost of the service(s), and on-going maintenance of the service(s).
3. Proposer shall be responsible for obtaining all permitting and land rights.

### **1.10 – CONTROL SYSTEM ACCEPTANCE TEST (CSAT)**

1. Proposer shall be responsible for all costs related to the CSAT, including all Company costs in support of the Proposer's CSAT.

## **SECTION 2 – INTERCONNECTION REQUIREMENTS**

Section 2 will provide information on the interconnection requirements and responsibilities.

### **2.1 – COIF REQUIREMENTS**

Please see Attachment 1 for single-line diagram showing the interconnection requirements. Proposers should do their own due diligence for costs to meet the technical requirements and bring the project to commercial operations. Company costs will be the same for all proposed projects.

Hawaiian Electric Company  
Company-Owned Interconnection Facilities Cost and Schedule Information

Company will build COIF up to the switch on the Seller side of the demarcation shown on Attachment 1. Proposer to build facilities to meet at that point.

## **2.2 – TELECOMMUNICATIONS REQUIREMENTS**

Please refer to the RFP for functional requirements for the project. Company will install a fiber-optic cable between Hawi Substation and the project site. Proposer will need to provide/install a patch panel in a communications cabinet at the project site for Company to terminate the fiber cables.

## **2.3 – TYPICAL SECURITY REQUIREMENTS**

Security requirements can vary based on many factors including, but not limited to, location, crime rate, environment, aspects of the surrounding area, terrain, accessibility, layout of the facility, etc. The specific requirements for each facility will be subject to final review during the design and engineering phase. Additional information, including the Company's Physical Security Strategy, is available upon request after execution of an NDA with the Company.

### **A. Proposer Responsibilities at Proposer Facility**

The Proposer shall be responsible to incorporate security components and systems for **their facilities** that consider the Security Guidelines for the Electricity Sector (CIP-014-2): Physical Security, as published by the North American Electric Reliability Corporation (NERC) and that at a minimum, meet the requirements below.

For Company-owned facilities within the Proposer's Facility, Company requires:

1. Standard 8ft high security fence with 3-strand barbed wire V-top.
2. Interior mounted 4' high cattle fencing.
3. All gates will be secured using a proprietary padlock system.
4. Proposer-owned cabinets/enclosures housing Company equipment shall be secured with a lock provided by Company.
5. Company requires 24/7 access to Company facilities within the Proposer facility.

## **SECTION 3 – TYPICAL COMPANY DURATIONS FOR INTERCONNECTION PROJECTS**

The tables below in Section 4 are to be used as a reference when developing an overall project schedule to assist Proposers in setting realistic durations and deadlines for critical milestones. These tables represent typical durations for the Company to complete the listed critical milestones that assist in moving the project through the IRS, Engineering, Procurement, and Construction phases. The durations below do not include time for Proposer to complete items they are responsible for. These high-level typical durations are for planning purposes only and is not intended to cover all project specific requirements. Specific project details can increase or

Hawaiian Electric Company  
Company-Owned Interconnection Facilities Cost and Schedule Information

decrease these durations. The detailed project schedule will be determined after the IRS is completed.

Milestone	Company-Build Duration	Notes
<b>IRS Phase</b>		
Model Validation	2-3 months	May increase depending on # of iterations
System Impact Study (SIS)	150 calendar days	Following Model Acceptance
<b>Engineering Phase</b>		
30% Design & Review	40 business days	
60% Design & Review	50 business days	Following 30% Design acceptance.
90% Design & Review	50 business days	Following 60% Design acceptance
Issued for Construction (IFC) Design & Review	30 business days	Following 90% Design acceptance.
<b>Procurement Phase</b>		
Procurement	9 months	Procurement of materials typically happens at 60% design completion
<b>Construction Phase</b>		
Construction	10-12 months	Based on scope/complexity of work
Acceptance Testing	30 business days	Approximately 3 weeks after construction completion
CSAT	30 business days	To occur after commissioning of Proposer's Facility. Duration depends on Proposer's ability to meet the Performance Standards.
<b>Notes</b>		
For Company-Build projects, the Engineering Phase includes Company design & review of Company-Owned Interconnection Facilities (COIF) & reviews of Proposer-Owned Interconnection Facilities (SOIF) supporting/impacting COIF.		

**DRAFT**

HAWI MICROGRID BESS SITE

- NOTES:**
- 24 HOUR ACCESS:  
ALL HECO EQUIPMENT MUST BE READILY ACCESSIBLE AT ALL TIMES (24 HOURS/7 DAYS) BY HECO PERSONNEL FOR EMERGENCIES, METER READING, INSPECTION, TESTING, AND MAINTENANCE.
  - ONLY ONE (1) SET OF OVERHEAD CONDUCTORS IS REQUIRED TO CONNECT TO THE CUSTOMER BREAKER.
  - 34.5KV GROUND SOURCE MUST BE ADDED BY THE PLANT.
  - BACKUP AUX POWER SOURCE CAN BE PROVIDED BY COMPANY BUT WILL REQUIRE SEPARATE METERING.
  - CRITICAL TELEMETRY DEVICES REQUIRED TO ENSURE THE SAFE AND QUALITY DELIVERY OF ENERGY FROM THE BESS ARE TO BE DESIGNED WITH REDUNDANCY SUCH THAT A SINGLE FAILURE OF ANY DEVICE DOES NOT RESULT IN ANY HAZARD OR POWER QUALITY ISSUE.
  - SYNCH-CHECK CAPABILITY IS REQUIRED.

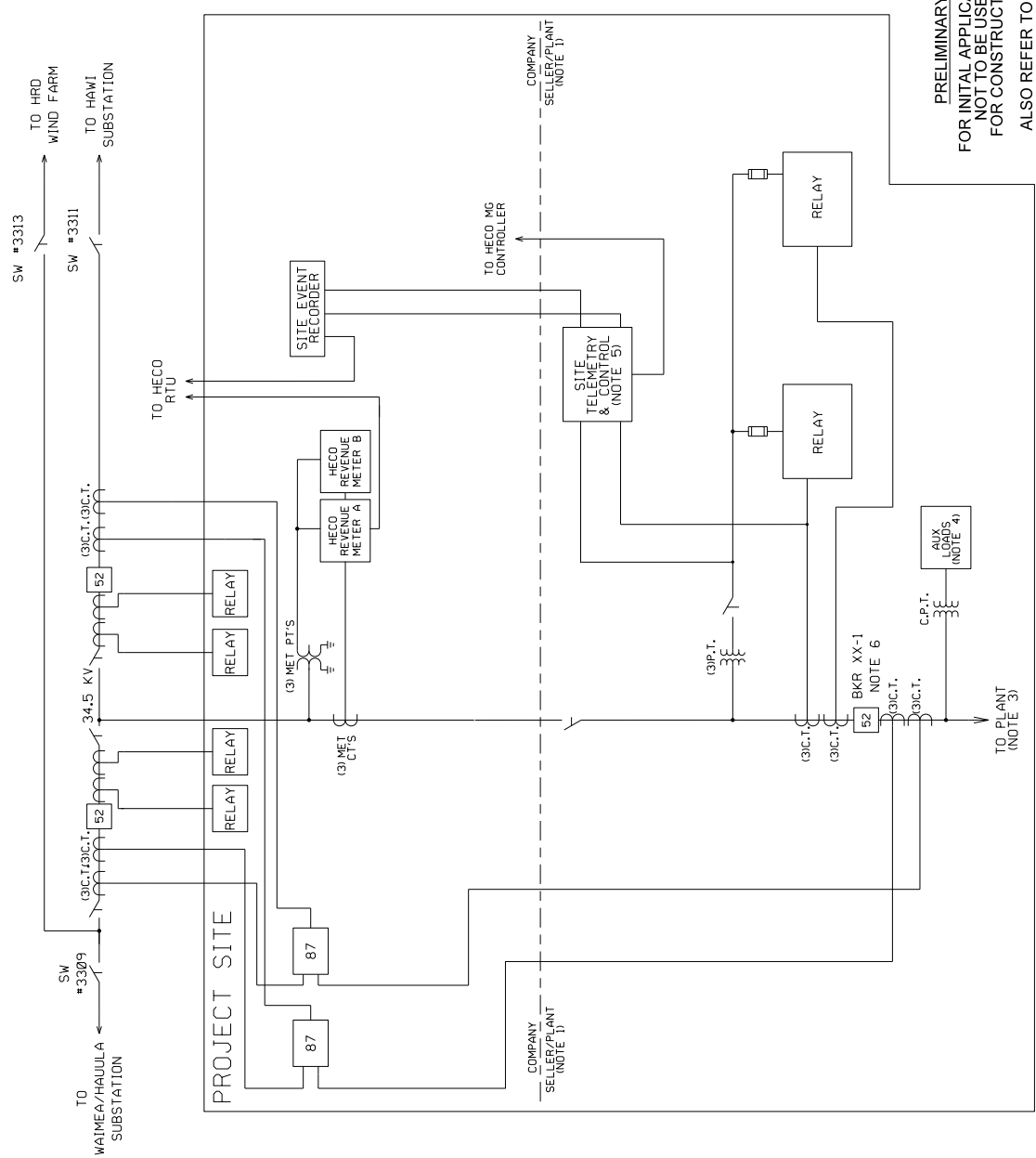

PRELIMINARY  
FOR INITIAL APPLICATION  
NOT TO BE USED  
FOR CONSTRUCTION  
ALSO REFER TO SLD  
DESIGN NOTES

NO.	DATE	REVISIONS	BY	CHKD	APP'D

HAWI MICROGRID BESS SITE INTERCONNECTION SINGLE LINE DIAGRAM			
DESIGNED	DATE: 8/28/2023	SCALE: N/E	HAWAIIAN ELECTRIC CO., INC. HONOLULU, HAWAII
CHECKED	DATE: 8/28/2023	SCALE: N/E	
APPROVAL	DATE: 8/28/2023	SCALE: N/E	
DRAWING NUMBER			REV: 0



DRAFT

**Additional notes to be added to the North Kohala Microgrid BESS Project Single Line Diagram**

<b>PROPOSED PROJECT NAME:</b>	North Kohala Microgrid BESS
<b>PROPOSED PROJECT SIZE:</b>	5 MW, 22 MWh BESS (Minimum)
<b>CUSTOMER SLD REVISION NUMBER AND DATE:</b>	
<b>HELCO SLD REVISION NUMBER AND DATE:</b>	Revision 0, 09-09-2021
<b>HELCO SUBSTATION:</b>	Hawi
<b>HELCO 34kV CIRCUIT:</b>	3300 Line
<b>HELCO 34kV CIRCUIT BREAKER #:</b>	TBD

**Transmission Planning Notes**

1. Customer to ensure manual closing of Project breaker XX-1[TBD] shall be allowed for the following conditions under coordination with the Company system operator:
  - a. Hot line (company-side) and hot bus (project-side) with supervised synchro-check for self-energization using grid forming capabilities
    - i. Voltages equal in magnitude and phase, and phase angle difference less than 20°
  - b. Dead-line (company-side) and hot bus (project-side) for black start capabilities
  - c. Hot line (company-side) and dead bus (project-side)
2. There shall be no auto-reclosing on Project breaker XX-1[TBD].

**Protection Notes**

3. The 34 kV bus at [Name TBD] shall have dual differential bus protection relays which will trip and block close HELCO breakers 52-1 and 52-2, and Project breaker XX-1 via manual lockout relays.
4. All 34 kV lines at [Name TBD] HELCO side shall have dual redundant, high-speed line protection relays with separate and diverse communication channels. The remote ends at the Maliu Ridge, Halaula, and Hawi substations shall have the same.
5. Breaker failure of HELCO 34 kV breaker 52-1 or 52-2 at [Name TBD] HELCO side shall trip and block close Project breaker XX-1[TBD] via separate dedicated lockout relay.
6. Breaker failure of HELCO 34 kV breaker 52-1 (or 52-2, whichever is connected to HRD and Waimea) at [TBD] HELCO side shall trip and block close the Waimea and HRD breakers via a separate dedicated lockout relay.
7. Breaker failure of Project breaker XX-1[TBD] shall trip developer-owned dedicated lockout relay which will trip dedicated lockout relay in HELCO side. Dedicated lockout relay in HELCO side will trip and block close HELCO 34 kV breakers 52-1 and 52-2.

## DRAFT

### Design Notes

8. All 34 kV CT's are to be xxxx/5 MRCT's with relaying accuracy class C400 unless noted otherwise. MRCT's are to have full distributed windings on all taps and a minimum thermal rating factor of 2.0.
9. HELCO to provide two bi-directional A and B meters that records both import and export power and revenue metering CTs and PTs.
10. The Project will submit design drawings to HELCO for review and comment.
11. The communications for the primary and secondary pilot protection relays and breaker failure communication for the Developer tie line must be on diverse communication routes.
12. For Telecom requirements (such as communications, etc.), refer to the Telecom SLD.
13. For the microgrid control system design and operation philosophy, refer to the Appendix O of the RFP.

### System Operations Notes

14. Upon simultaneous communication channels failure longer than 6 seconds for the following channels:
  - a. (only applicable if HELCO applies Line Diff Protection) Protection Channels X & Y (as applicable) HELCO-owned protection relay to initiate a "loss of protection communication" alarm to HELCO dispatch.
    - i. After 30 seconds of simultaneous failure the HELCO-owned relays are to provide signal to Project to initiate Project perform a controlled ramp of the plant output to 0 MW net. At zero (0) MW, Project to trip Project breaker XX-1[TBD]
  - b. Telemetry and Control Channels A & B HELCO-owned RTU to initiate a "loss of communication" alarm to HELCO dispatch.
15. The following Developer's inputs shall be provided and direct hard wired to HELCO's recorder:
  - a. Status of all Developer's 35kV breaker
  - b. Status of all lockouts for Developer's breaker
  - c. 34kV voltage (3-ph) at point of interconnection
  - d. 34kV current (3-ph) at point of interconnection
16. HELCO load dispatcher shall be enabled to issue the following to the Facility via SCADA interface:
  - a. Active power set point control signal (analog MW); and
  - b. Voltage (analog kV) set point control signal.
  - c. Frequency Response mode (droop, isochronous, disabled)
  - d. Grid Forming Control (enable/disable)

DRAFT

- e. Transition to islanding Mode (enable/ disable)
  - f. 34kV Project breaker (trip/close)
17. All control values must be retained in non-volatile memory such that will be restored immediately upon return from Plant Controller restart, power outage, loss of communication, etc.
18. The Project will provide the following signals for telemetering to the HELCO RTU:
- a. 34kV line amps (3 phase), watts, vars, and voltage (3 phase)
  - b. Status of the Project breaker XX-1[TBD]]
  - c. Status of all lockouts
  - d. Active Power Control Interface Status indicating Local vs. HELCO
  - e. Latest received active power set point
  - f. Automatic Voltage Regulator Status – Normal or Alarm (regulator On or Off)
  - g. Grid Forming Status (Enabled/Disabled)
  - h. Frequency Response mode (droop, isochronous, disabled)
  - i. Latest received voltage setpoint (kV)
  - j. Status for each inverter
  - k. MW output for each inverter
  - l. MW set point for each inverter
  - m. BESS State of Charge (%)
  - n. Available Maximum Ramp Rate (MW/min)
  - o. Power Production of Facility (MW)
  - p. Number of Inverters Available
  - q. Facility Inverter Availability (%)
  - r. Frequency Droop percent and deadband settings (% & Hz)
19. Each of the following initiates a separate alarm to HELCO load dispatcher:
- a. Protection and RTU Loss of Communication

**DRAFT**  
**REQUEST FOR PROPOSALS**  
**FOR**  
**NORTH KOHALA**  
**ENERGY STORAGE**  
**ISLAND OF HAWAI‘I**

OCTOBER 29, 2021

Docket No. TBD

*Appendix I – RESERVED*



**Hawai'i  
Electric  
Light**

**DRAFT**  
**REQUEST FOR PROPOSALS**  
**FOR**  
**NORTH KOHALA**  
**ENERGY STORAGE**  
**ISLAND OF HAWAI‘I**

OCTOBER 29, 2021

Docket No. TBD

*Appendix J – RESERVED*



**Hawai'i  
Electric  
Light**

**DRAFT**  
**REQUEST FOR PROPOSALS**  
**FOR**  
**NORTH KOHALA**  
**ENERGY STORAGE**  
**ISLAND OF HAWAI‘I**

OCTOBER 29, 2021

Docket No. TBD

*Appendix K – Community Comments*

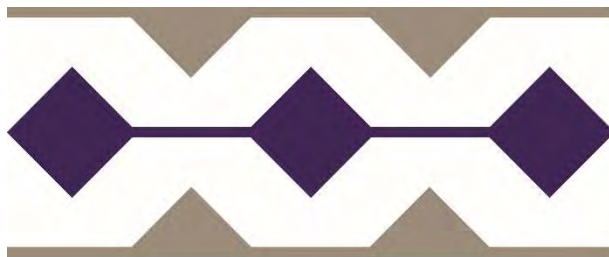

**Hawai'i  
Electric  
Light**

## North Kohala Community Meeting Feedback (written comments received by Hawai'i Electric Light Co., Ltd.)

The Company held two community meetings, a Resilience and Sustainability Forum on November 7, 2019 and Building Resilience in North Kohala meeting on August 6, 2019. Provided below are the presentations used by the Company at the meetings, as well as question cards received from the community from the November 7, 2019 meeting.

November 7, 2019 - Resilience and Sustainability Forum Presentation

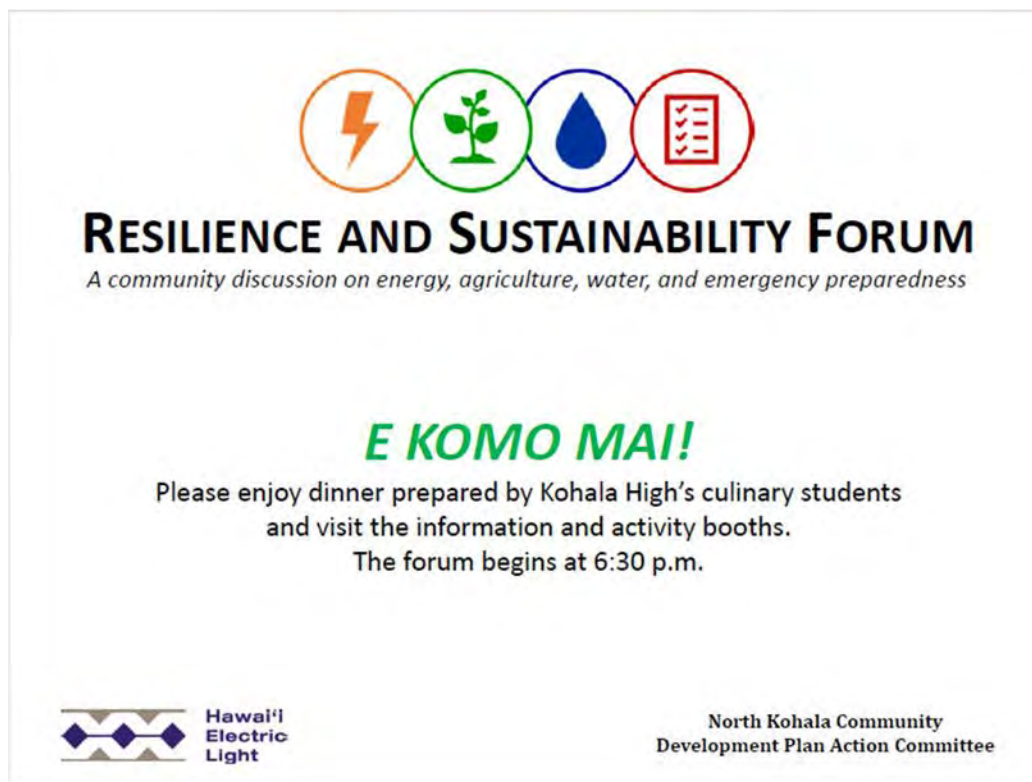

The slide features a header with four circular icons: a lightning bolt (orange), a plant (green), a water drop (blue), and a checklist (red). Below the icons is the title "RESILIENCE AND SUSTAINABILITY FORUM" in bold black text, followed by the subtitle "A community discussion on energy, agriculture, water, and emergency preparedness" in a smaller, italicized font. The main message "E KOMO MAI!" is written in large green letters. Below this, it says "Please enjoy dinner prepared by Kohala High's culinary students and visit the information and activity booths. The forum begins at 6:30 p.m." The bottom left corner has the Hawai'i Electric Light logo, and the bottom right corner has the text "North Kohala Community Development Plan Action Committee".

**RESILIENCE AND SUSTAINABILITY FORUM**  
*A community discussion on energy, agriculture, water, and emergency preparedness*

**E KOMO MAI!**

Please enjoy dinner prepared by Kohala High's culinary students  
and visit the information and activity booths.  
The forum begins at 6:30 p.m.

Hawai'i Electric Light

North Kohala Community  
Development Plan Action Committee



# RESILIENCE AND SUSTAINABILITY FORUM

*A community discussion on energy, agriculture, water, and emergency preparedness*

November 7, 2019  
Kohala High School



North Kohala Community  
Development Plan Action Committee



## JEFF COAKLEY

North Kohala Community Development Plan Action Committee

## SHARON SUZUKI

Hawai'i Electric Light

## SHERRY BRACKEN, moderator

Hawai'i Public Radio, New West Broadcasting (KWXX, B97-B93)

## DR. TIM RICHARDS

Hawai'i County Council

## LAUREN RUOTOLO

Hawai'i Institute of Pacific Agriculture

## TALMADGE MAGNO

Hawai'i County Civil Defense

## KEVIN WALTJEN

Hawai'i Electric Light

## Q&A SESSION

## CLOSING REMARKS



## **Welcome and Introductions**

*Moderator Sherry Bracken  
Hawai'i Public Radio, New West Broadcasting (KWXX, B97-B93)*

## **Dr. Tim Richards**

*Hawai'i County Council  
Chair of the Committee on Agriculture, Water, Energy and Environmental Management  
Vice Chair of the Committee on Finance*

# Hawai'i Institute of Pacific Agriculture

*Lauren Ruotolo*  
*Director of Development*

## Hawaii Institute of Pacific Agriculture's role in the Food System

Farmers



Educators



Aggregators



## FARM



## YOUTH EDUCATION

- Farm Field Trips
- In-School Workshops





## YOUTH EDUCATION

- Mahi'ai Mentorship & Internship Program



## Garden to Cafeteria & Farm to School



## Post-Secondary Education

- Farmer Apprenticeship



## Food Aggregation

- The Kohala Food Hub





## The Kohala Food Hub



## Looking Ahead

More info:  
[www.hipagriculture.org](http://www.hipagriculture.org)  
[institute@hipagriculture.org](mailto:institute@hipagriculture.org)



# Hawai'i County Civil Defense

*Talmadge Magno*  
Administrator

## Hawaii County Civil Defense

Talmadge Magno, Administrator  
808-935-0031  
*Talmadge.Magno@hawaiicounty.gov*

**Aloha!**

- Mission
- All Hazards
- Coordination of Communications and Education
- Coordination of Government, Public and Private Partners

**Mission:**

- **Prepare for and Respond to Emergencies and Disasters**
  - Establish Resilient Communities
- **Provide Emergency Communications and Public Information**
  - Establish Redundant Systems
- **Direct and Coordinate Planning, Response and Recovery actions**
  - Establish Comprehensive Plans

Export P



## Responds to all hazards and associated risks...

- Earthquake
- Tsunami
- Tropical Cyclone
- Wild Fire
- Flash Flood
- Lava Flow
- Vector-borne Disease
- Dam Failure
- HAZMAT

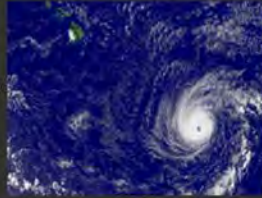

2008 Earthquake - 8.7 mag



## Critical Functions of Civil Defense

- Mass Notification
  - IPAWS
  - EAS
  - Everbridge
  - Facebook
  - Twitter
  - Na Leo TV and Online
  - Website
  - Outreach and Education

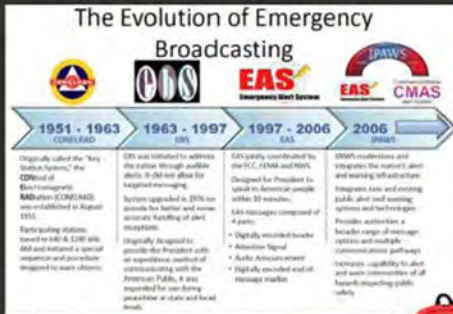

# Hawai'i Electric Light

*Kevin Waltjen*  
*Director – Hawai'i Island*

## 3 Pillars of Resilience

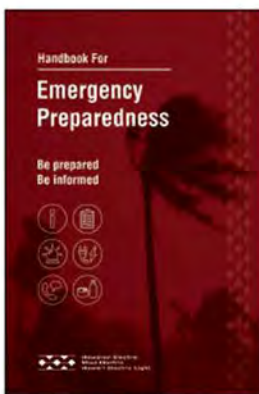

**COMMUNITY  
PREPAREDNESS**

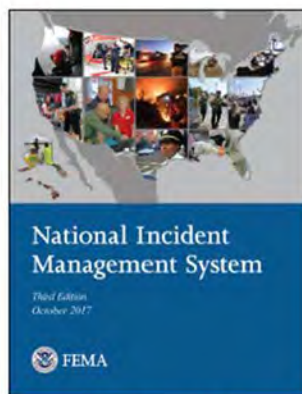

**GOVERNMENT  
PREPAREDNESS**



**RISK  
REDUCTION**



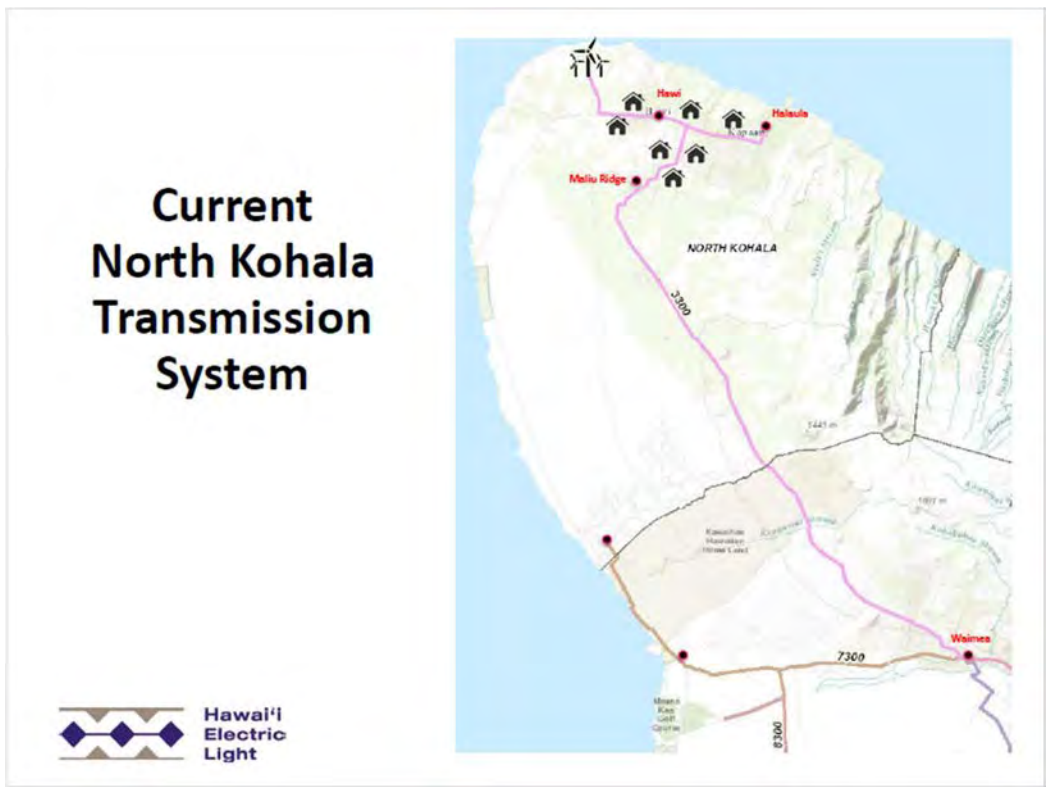
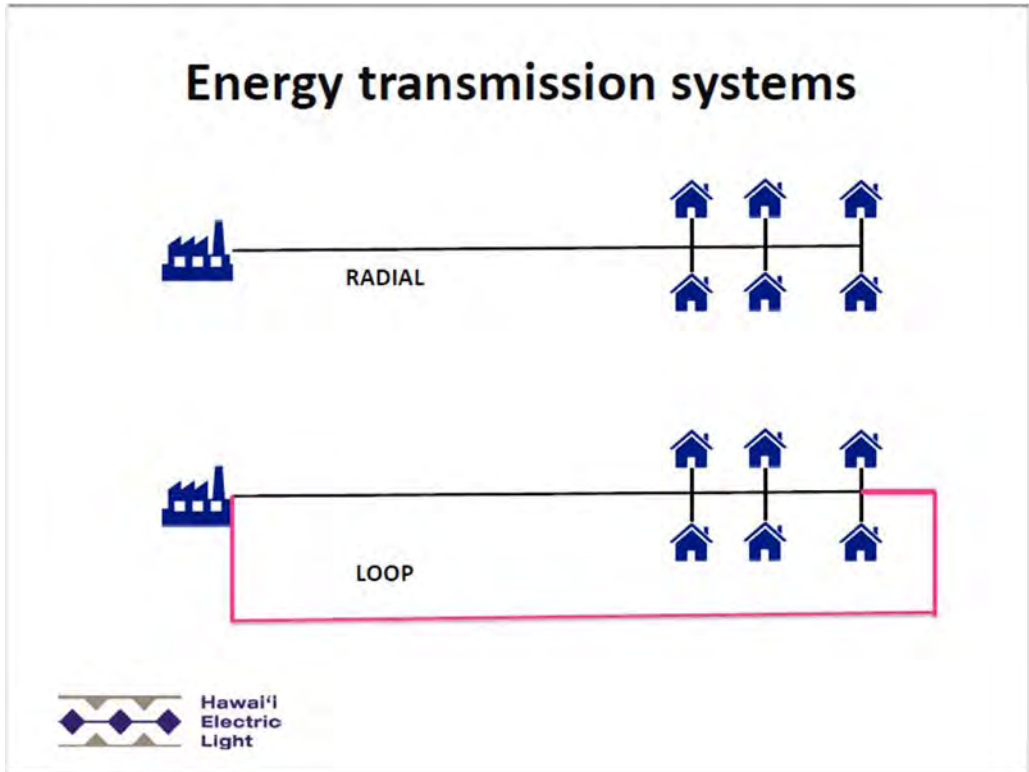

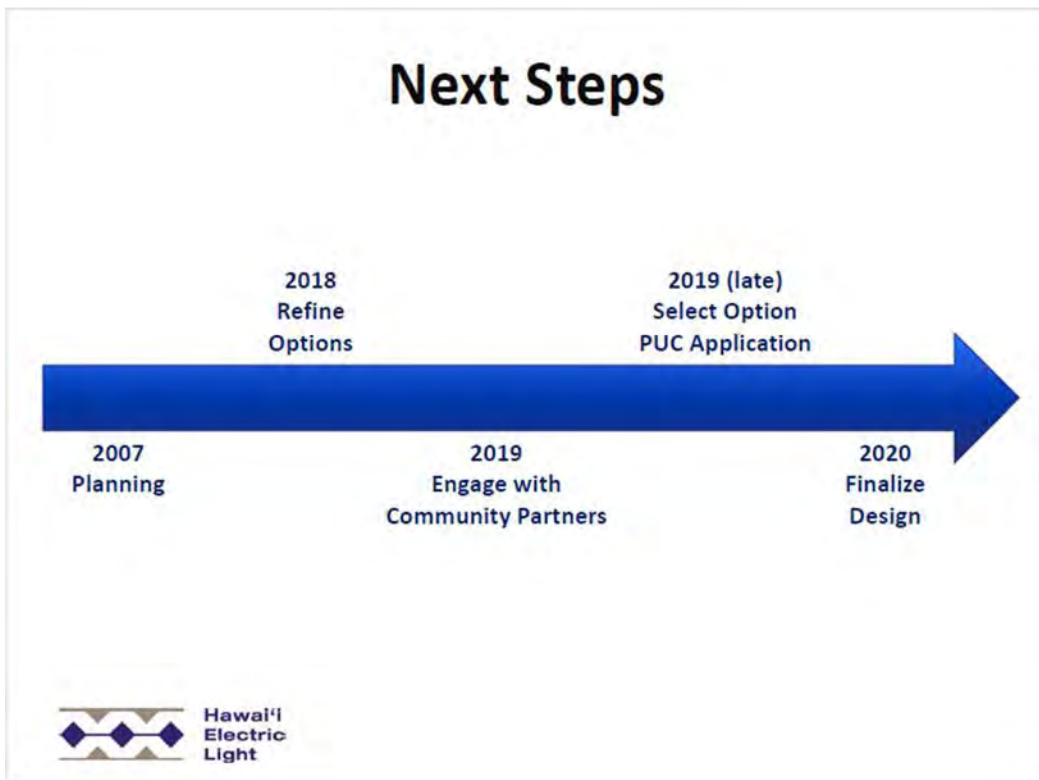
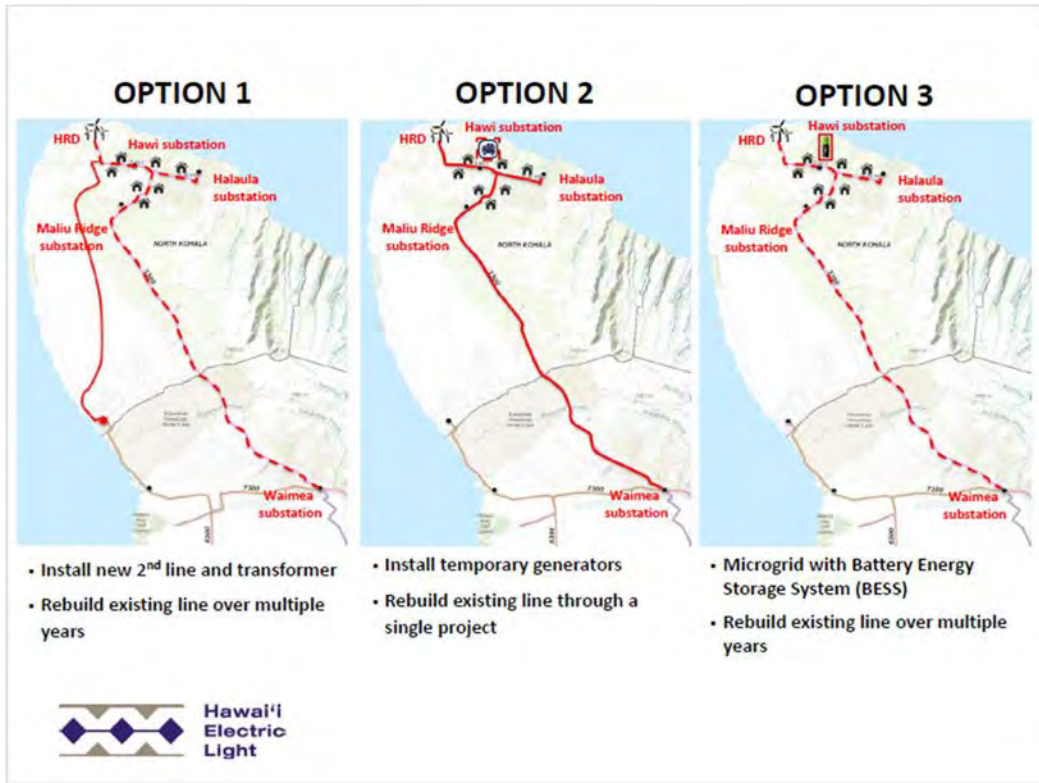



## Q&A Session

Please write your question on the card provided and hand it to one of the event staff. Questions will be read by our moderator.



# Mahalo!

November 7, 2019 - Resilience and Sustainability Forum Question Cards  
\*Names have been redacted.

Please PRINT your question(s) below.  
This card will be collected during the Q&A portion of tonight's forum. Mahalo!

HELCO  
DO YOU MARKUP THE PRICE OF OIL YOU BUY FOR ELECTRICITY GENERATION? ?

---

HELCO  
CAN THE SECOND LINE USE THE SAME ROUTE EVEN SAME POLES OR SECONDARY POLES?

Please PRINT your question(s) below.  
This card will be collected during the Q&A portion of tonight's forum. Mahalo!

How much is this going to cost each family?  
Will our electricity increase dramatically?  
It's already expensive. We may not be able to afford an increase.

Please PRINT your question(s) below.  
This card will be collected during the Q&A portion of tonight's forum. Mahalo!

① Is the current power demand for Kohala at a level that can be sustained using the micro-grid option? Are there any plans to help reduce our power demands prior to the start of the project?

② It sounded like the biggest downside to option 1 (and line) was that it would be an eyesore? Is there a possibility of burying the power lines for the loop portion? Is the micro grid option more cost effective overall?

Please PRINT your question(s) below.  
This card will be collected during the Q&A portion of tonight's forum. Mahalo!

What about developing a microgrid system that can be used more permanently - not just for emergencies - making use of local wind/solar to reduce use of fossil fuels?

Please PRINT your question(s) below.  
This card will be collected during the Q&A portion of tonight's forum. Mahalo!

Are there any plans to install reliable EV charging stations in N. Kohala to create a reliable network of charging stations throughout the island so that owning an EV on island is possible.

Please PRINT your question(s) below.  
This card will be collected during the Q&A portion of tonight's forum. Mahalo!

█ : How much agriculture required to run all tractors on biodiesel trucks

█ : How much electric production to run all cars on electricity



Please PRINT your question(s) below.  
This card will be collected during the Q&A portion of tonight's forum. Mahalo!

How much does climate change figure into the plans for our future?

HELCO

Please PRINT your question(s) below.  
This card will be collected during the Q&A portion of tonight's forum. Mahalo!

with Option 3  
will HELCO be able to use the full energy production of the wind farm?



Please PRINT your question(s) below.  
This card will be collected during the Q&A portion of tonight's forum. Mahalo!

As HELCO moves forward  
in this Kohala project, how will  
you keep the Kohala community  
informed about progress?  
How can we give input on this  
project?

## POWER

What are the plans AND timetables  
for getting off fossil fuels completely  
and moving to geothermal energy.

Please PRINT your question(s) below.  
This card will be collected during the Q&A portion of tonight's forum. Mahalo!

Please PRINT your question(s) below.  
This card will be collected during the Q&A portion of tonight's forum. Mahalo!

THE COMMUNITY IS CONCERNED ABOUT HEALTH RISKS FROM ELECTRO-MAGNETIC RADIATION. ESPECIALLY FROM "SMART METER" AND THE IMPLEMENTATION OF 5G CELLULAR INFRASTRUCTURE.  
HOW CAN WE PROTECT OUR COMMUNITY FROM THIS RADIATION AND MAINTAIN PEOPLE'S POWER TO CHOOSE WHAT THEY'RE BEING EXPOSED TO?

Please PRINT your question(s) below.  
This card will be collected during the Q&A portion of tonight's forum. Mahalo!

There is a lot of talk about the dangers of 60 Hz electrical distribution. Please tell us what the negative possibilities & effects will do to the human body.

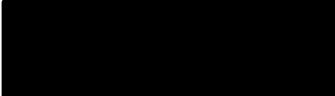

Please PRINT your question(s) below.  
This card will be collected during the Q&A portion of tonight's forum. Mahalo!

Is there a plan to maintain this "regenerated agriculture" after the field trips and lessons? Most of Kohala's community find it ~~expensive~~ <sup>more</sup> cost efficient to buy their food in bulk from manufacturers like Costco. Will this plan include provide affordable produce for everyone in the community?

August 6, 2019 - Building Resilience in North Kohala Presentation

## Agenda

- ◆ Welcome and introductions
- ◆ Building Resilience in North Kohala
- ◆ Hawai'i Energy
- ◆ Feedback
- ◆ Closing remarks



# Building Resilience in North Kohala

*A collaborative approach to strengthening our communities*



Hawaiian Electric  
Maui Electric  
Hawai'i Electric Light

## 3 Pillars of Resilience

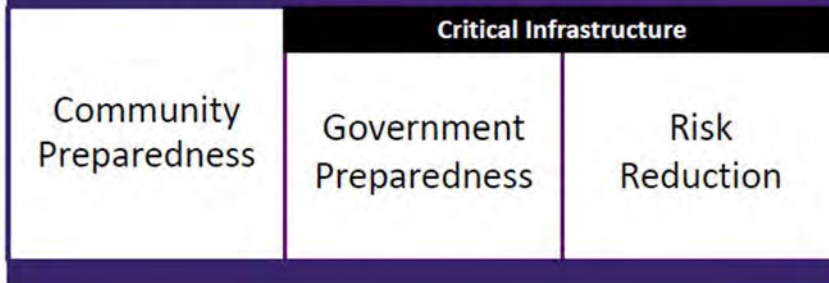

Hawaiian Electric  
Maui Electric  
Hawai'i Electric Light

## Energy transmission systems

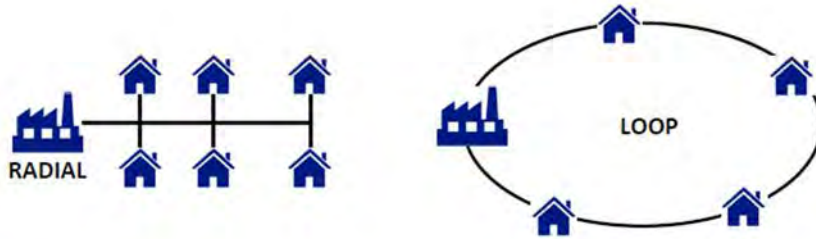

 Hawaiian Electric  
Maui Electric  
Hawai'i Electric Light

## Current North Kohala Transmission System



 Hawaiian Electric  
Maui Electric  
Hawai'i Electric Light

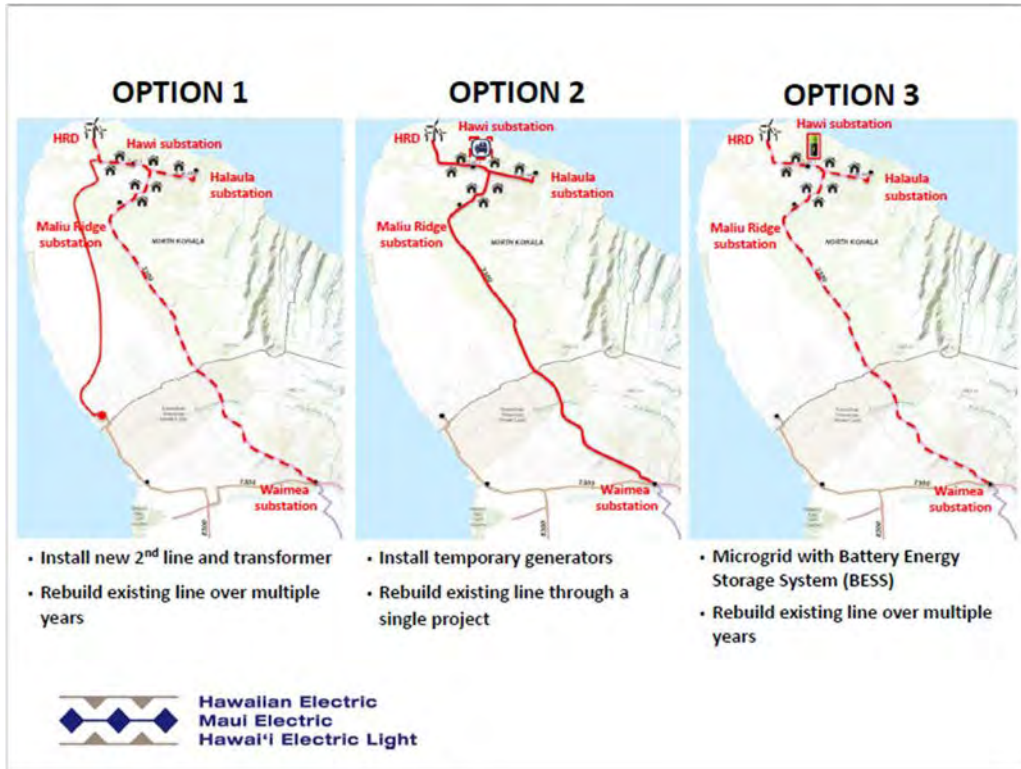

## Microgrid with BESS





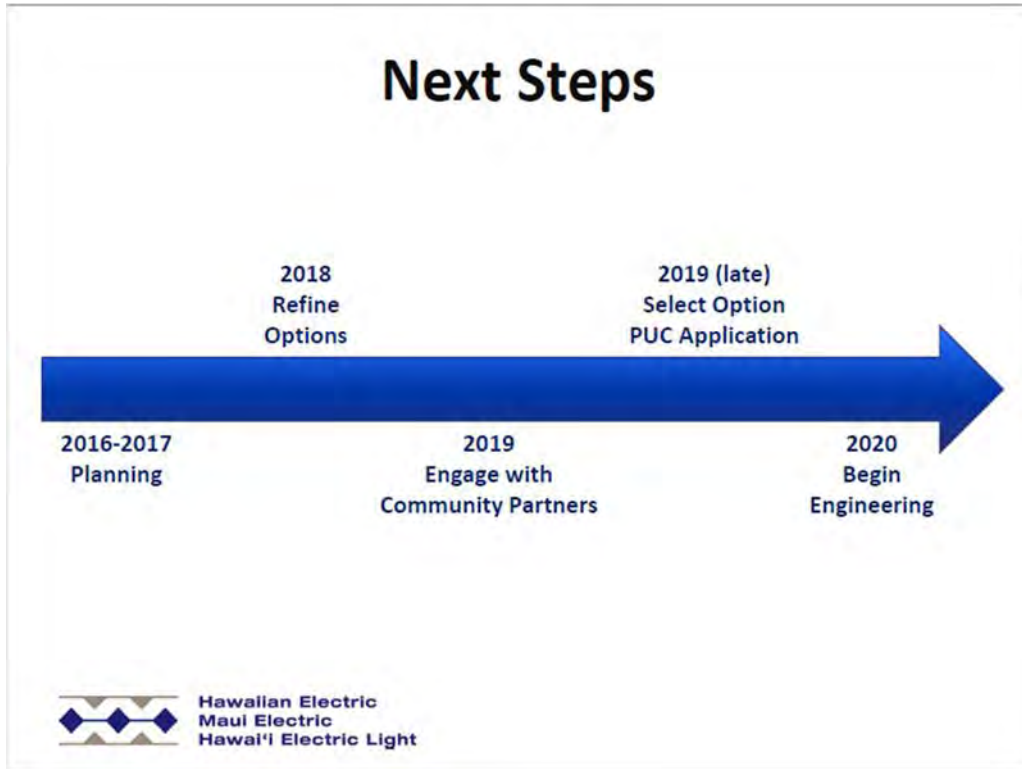



**Graceson Ghen**  
[Graceson.ghen@leidos.com](mailto:Graceson.ghen@leidos.com)  
808-895-6713

Leidos Property

  [hawaiienergy.com](http://hawaiienergy.com)

## Residential Rebate Offerings

**QUICK FIXES: SHOP SMARTER AND SAVE MONEY WITH THESE PRODUCTS**

Always make sure you look for ENERGY STAR certified products to get the most energy savings. (Energy Star is a U.S. Environmental Protection Agency program.)

**LED Light Bulbs**  
Not all LEDs are created equal. ENERGY STAR certified bulbs last longer and **save you up to 90% on energy costs.**

**Clothes Washers & Dryers**  
Save loads of money and energy by upgrading to an energy efficient washer and dryer. Purchase an ENERGY STAR certified washer and/or dryer for cutting edge technology alongside the highest energy efficiency savings possible.

**Refrigerator Trade-Up**  
**SAVE \$50**  
Get a rebate when you trade in your old working, energy-consuming refrigerator for a qualifying ENERGY STAR model.

**Electronics Offer**  
Purchase ENERGY STAR sound bars and TVs that'll boost your home's energy efficiency, protect the environment, and save you money!

**Window A/C Trade-Up** **SAVE \$50**  
Trade an old, working window A/C unit for a qualifying ENERGY STAR one and save.

**Rid-A-Fridge** **NOW RECEIVE \$75**  
If you just want to get rid of that old, working fridge or freezer, we'll recycle it for you. We'll even pay you up to \$75 for each one through the Rid-A-Fridge program.

**Heat Pump** **SAVE \$500**  
Heat pump water heaters can be 2-3 times more efficient than conventional electric water heaters, saving you money!

**Smart Thermostats**  
Save on your home's cooling costs by replacing your old thermostat with a new smart thermostat. You can "set it and forget it" for ease of use, convenience and energy efficiency.

**WHO DOESN'T LIKE FREE MONEY?**



©2016 Hawaiian Energy Services, Inc.

## Residential Rebate Offerings

**PRO UPGRADES: LET US HELP YOU FIND A CONTRACTOR FOR THESE ENERGY-SMART INSTALLATIONS**

WATER HEATING UPGRADES	COOLING & POOL UPGRADES
<p><b>Solar Water Heater</b> <b>NOW SAVE \$750</b> Switching from an electric water heater to a solar water heater can <b>save you up to 40% on your electric bill per year.</b> Plus, you'll earn state and federal tax credits!</p>	<p><b>AC Tune-Up Offer</b> <b>NOW SAVE \$100</b> Keep your home's comfort or spa/ice conditioning system running in tip-top shape by booking a maintenance tune-up. When you do, you'll receive an instant rebate.</p>
<p><b>Solar Water Heater Tune-Up</b> <b>SAVE \$100</b> Save instantly when you have your solar water heater serviced by a participating contractor. Hawaii Energy recommends maintenance every 1-3 years.</p>	<p><b>Mini-Split Air Conditioner</b> <b>SAVE UP TO \$250</b> Mini-Split Air Conditioner (also known as Variable Refrigerant Flow or VRF) is a great cooling solution for multiple rooms while saving energy. Get a 25% or 50% rebate based on system size.</p>
	<p><b>Solar Attic Fans</b> <b>SAVE \$50</b> Cool your home and give your AC a break! Get a fan and receive a rebate.</p>
	<p><b>Whole House Fan</b> <b>SAVE \$75</b> Draw in cooler, outside air through your home. Install today and get an easy rebate. That's cool.</p>
	<p><b>VFD Pool Pump</b> <b>SAVE \$125</b> Get a rebate when you replace your inefficient pool pump with a qualifying energy-efficient one.</p>

**WHAT'S AS EXCITING AS GREEN ENERGY? GREEN MONEY. KEEP MORE OF IT IN YOUR POCKET.**

[HAWAIIENERGY.COM/SAVINGS](http://HAWAIIENERGY.COM/SAVINGS)

©2016 Hawaiian Energy Services, Inc.



## Lānaʻi Community Projects

### Energy Smart 4 Homes

- Over 250 units retrofitted at 3 multifamily properties
- ~200 Pūlama Lānaʻi-owned single family residences retrofitted to date

### Bulk Purchase Appliance Program

- Over 100 Pūlama Lānaʻi refrigerator replacements
- 13 Lānaʻi City community refrigerator replacements

### Community Workshops & Literacy

- Multiple community presentations and workshops



LEIOW Proprietary



# Commercial Rebates

Hawaii Energy

Hawaii Energy makes it easy to implement your projects quick. We help you identify energy-saving opportunities and provide attractive financial incentives that significantly offset costs, reduce payback periods and positively impact your bottom line. To get started, call us at 839-8880 (Oahu) or 1-877-231-8222 (toll-free neighbor islands), or visit our website at [HawaiiEnergy.com/for-businesses](http://HawaiiEnergy.com/for-businesses).

**PLEASE NOTE:** All incentives require a completed and signed application, relevant worksheets, product specifications and project invoices. All documents can be submitted via email to [HawaiiEnergy@leidos.com](mailto:HawaiiEnergy@leidos.com) or faxed to (808) 441-6068.



**Important:** AC system size is taken as the AHRI rated system capacity, not the nominal system capacity which is rounded to the nearest whole number. Please see corresponding worksheet for eligibility requirements

Chillers	
Positive Displacement	\$45/ton
Centrifugal	\$45/ton
Air-cooled with condenser	\$45/ton

Air-Cooled Package/Split	
Package/Split	Tier 1: \$100/ton
Package/Split	Tier 2: \$175/ton

*Note:* Refer to custom program for units with capacities greater than 600 tons.

Water-Cooled Package/Split	
Package/Split	\$100/ton

Water-source Heat Pumps	
Water-source heat pump	\$100/ton

VRF Multisplit AC and Heat Pumps	
Multisplit AC	\$250/ton

Variable Frequency Drives	
VFD controls for HVAC fans; new construction > 7.5 hp not eligible	\$50 per HP
VFD controls for Chiller and Condenser Water pumps	\$80 per HP



**Advanced Metering & Controls**

*Advanced metering: Retrofit only; new construction not eligible. Condos and small businesses must be master-metered. Projects are subject to pre-approval and meet other Program requirements.*

Advanced Metering	
Equipment Category	Incentive
Condominium submetering	\$150 per billed unit
Small Business / Tenant submetering	\$150 per billed unit

Controls	
Equipment Category	Incentive
Energy Management Systems	\$0.12 per kWh
Hotel Room EMS	\$75 per unit
Garage Exhaust Ventilation	\$0.12 per kWh
Vending Machines	\$50 per system



**Pumps & Motors**

*Pre-approval required. Existing equipment must not have VFD and all motors must meet CEE Premium Efficiency Standards. Please see corresponding worksheet for eligibility requirements*

Motors	
Equipment Category	Incentive
Electronically Commutative Motors (ECM) & Speed Control for Commercial Refrigeration (retrofit only)	\$85 each
Electronically Commutative Motors (ECM) & Speed Control for HVAC Fan Coil Applications	\$55 each
Premium Efficiency Motors	Refer to worksheet

Pumps	
Equipment Category	Incentive
VFDs for Pool Pumps	\$225 per HP
<ul style="list-style-type: none"> <li>Pre-approval required</li> <li>3HP or less (&gt; 3HP see Customized)</li> <li>Existing equipment must not have VFD</li> </ul>	
VFD Domestic Water Pump System	\$3,000 + \$80 per HP reduced
<ul style="list-style-type: none"> <li>Retrofit only; pre-approval required</li> <li>Total HP must ≤ to existing system; limited to system reduction of ≤ 120HP.</li> <li>All motors must meet CEE Premium Efficiency Standards.</li> </ul>	



**Refrigeration & Kitchen Equipment**

*Refrigerators: New unit must be > 16 cu. ft.; trade-in must be > 14 cu. ft. Night covers: On existing open refrigerated display cases*

*Anti-Sweat Heater Controls: Replacement of existing controls. New refrigerators/freezers and walk-in units manufactured after 1/1/09 not eligible.*

Specialty Kitchen Equipment	
Equipment Category	Incentive
ENERGY STAR® Refrigerators (Trade-In)	\$150 per unit
Refrigerated Night Covers	\$10 per lin. ft.
Anti-Sweat Heater Controls (for refrigerator/freezer)	\$40 per lin. ft.
Kitchen Exhaust Hood Demand Ventilation	\$700 per HP
ENERGY STAR® Commercial Kitchen Equipment	Various- see separate worksheet

 **Water Heating**

*Heat pump requirements*

Tons	5 - 11.25	> 11.25
COP	3.3	3.2

Please see corresponding worksheet for eligibility requirements

Commercial Water Heating	
Equipment Category	Incentive
Heat Pump Water Heating	Based on size and COP
Commercial Solar Water Heating	\$250 / ton de-rated output

 **Energy Services & Maintenance**

Requires pre-approval and must meet other Program requirements, see corresponding Rules & Requirements for details.  
*\*Incentives capped by building square footage as well.*

Energy Services & Maintenance	
Equipment Category	Incentive
Re-Commissioning & Retro-Commissioning	Total incentive is the sum of two parts below, capped at a total of 80% of total project cost: 1. The lesser of: 50% of study cost, \$0.20 per square foot, or \$15,000. 2. Additional \$0.08 per kWh saved in the first year
Energy Audits	85% up to \$5,000* 50% up to \$15,000*
Energy Study	Additional incentives available to implement measures as a result of the study

 **Building Envelope**

*New construction, shaded or north-facing windows not eligible. Solar heat gain coefficient must be < 0.435 or shading coefficient < 0.5.*

Building Envelope	
Equipment Category	Incentive
Window Film	\$0.85 per sq. ft.

Incentive rate is halved for replacement window film, see worksheet

 **Customized Projects**

*Lighting projects must have a payback > 6 months. Non-lighting projects must have a payback > 1 year. Incentive cannot exceed 50% of incremental project cost.*

Custom		
Equipment Category	Equipment Life	Incentive
Lighting Projects	≤ 5 Years	\$0.08 / kWh
Lighting Projects	> 5 Years	\$0.12 / kWh
Non-Lighting Projects	≤ 5 Years	\$0.08 / kWh
Non-Lighting Projects	> 5 Years	\$0.12 / kWh

 **Transformers**

- Commercial customer-sited and customer-owned transformer (not utility-owned)
- Must meet or exceed DOE 2016 efficiency standards
- Existing transformer must be manufactured/installed prior to 2007
  - Transformers installed after 2007 may still qualify on a case-by-case basis; contact Hawaii Energy for more information.
- Must serve the same load as the pre-existing transformer

> 1000 kVA may qualify under the Custom Incentive Program

Transformers	
Equipment Category	Incentive
New Transformer	\$0.12 / kWh + \$125 per kW (5pm-9pm)

 **Electric Vehicle Charging Stations**

**Important:**  
*Available through September 30, 2019.*

- UL-listed, dual-port, Level 2 EV Charging Stations with network connectivity
- Charging station usage for tenants, employees and/or authorized guests; not intended for fleet-charging, individually-owned parking stalls or single family homes
- Appropriate number of parking stalls and regulatory signage required

For more details:  
<https://hawaiienergy.com/evcharging>

EV Charging Stations	
Equipment Category	Incentive
Workplace: Place of business generally open between 7am-5pm	New installation: \$5,000 per dual-port station (i.e., no pre-existing station)
Multi-Unit Dwelling: Apartment/Condos with at least 8 parking stalls	Retrofit: \$1,500 per dual-port station (i.e., upgrade from a single-port to dual-port station)

 **New Construction**

For new construction projects, contact us at [hawaiienergy@leidos.com](mailto:hawaiienergy@leidos.com)

New Construction	
Equipment Category	Incentive
Various measures that exceed code and will result in a more energy-efficient project, subject to Hawaii Energy approval.	Customized





**LED Lighting**



Hawaii Energy

All LED lamps and fixtures must be listed by ENERGY STAR®, Design Lights Consortium (DLC) or LED Lighting Facts.

Type A = Plug & Play  
Type B = Internal driver / Line voltage  
Type C = External Driver  
Note: Type A designated lamps fitted with an external driver do not qualify for Type C incentives.

**LED: Linear**

T12   T8 Replacement		
Lamp Length	Type	Incentive (per lamp)
2 ft.	A or B	\$3.00
	C	\$5.00
3 ft.	A or B	\$4.00
	C	\$8.00
4 ft.	A or B	\$4.00
	C	\$8.00
8 ft.	A or B	\$7.00
	C	\$14.00
T5   T5 High Output (HO) Replacement		
4 ft. T5	A or B	\$4.00
	C	\$8.00
4 ft. T5 HO	A or B	\$5.00
	C	\$10.00

**LED: U-Bend**

Lamp Technology	Type	Incentive (per lamp)
2 ft. LED Retrofit	A or B	\$4.00
** (Replaces 4 ft. U-bend)	C	\$8.00
** Replacement system must have anodized aluminum reflectors.		
4 ft. U-bend LED	A or B	\$5.00
(Processed as 4 ft. Linear)	C	\$10.00

**LED: Troffer**

Fixture Size	Incentive (per fixture)	
	DLC Category: Indoor Luminaires or Indoor Retrofit Kit*	DLC Category: Indoor Retrofit Kit**
2 ft. x 2 ft.	\$20.00	\$10.00
1 or 2 ft. x 4 ft. (2 lamp replacement fixture)	\$20.00	\$14.00

\* General Application: Troffer; Primary Use: Ambient Lighting or Integrated Retrofit Kits \$50.00 \$20.00  
\*\* General Application: Troffer; Primary Use: Linear Retrofit Kits (3 or 4 lamp replacement fixture)

**LED: Directional & Omni-Directional**  
*LED down can kit retrofit must use custom worksheet*

Lamp Type	Incentive (per lamp)
A-series (ex: A19) / globe / decorative with screw/GU base	\$1.50
Replacement for plug-in CFL, 2 or 4-pin base (ex: PL)	\$4.00
Directional (ex: MR16, PAR38/R, 20/30/38/40) - screw/pin base	\$5.00

**LED: Exit Sign**

New LED Fixture	\$15.00 per sign
-----------------	------------------

**LED: Corn Cob (HID replacement)**

- Replacement lamps must be Type B or Type C.
- Ballast must be removed.
- E26 medium base lamps can qualify for prescriptive incentive if product meets DLC 4.3 technical requirements.

LED Lamp Wattage	Incentive (per lamp)
Less than 35W	\$20.00
36W to 149.9W	\$25.00
150W to 219.9W	\$35.00
Greater than 220W	\$45.00

**LED: Refrigerated Case Lighting**  
*For vertical reach-in refrigerated case lamps and kits*

Lamp Length	Incentive (per lamp)
4 ft. retrofit kit	\$25.00
5 ft. or 6 ft. retrofit kits	\$50.00



**Fluorescent Lighting**

**Fluorescent: Delamping**

Length of Lamps	Incentive (per lamp)	
	With Reflectors	Without Reflectors
Remo		
ved		
2 ft.	\$5.00	\$2.50
4 ft.	\$7.50	\$3.75
8 ft.	\$15.00	\$7.50

Note: Reflectors must have a minimum reflective efficiency of 90%. Process MUST include removal of all disconnected ballasts, lamps, and lamp holders (if applicable) from fixture.



**Lighting Controls**

**Occupancy Sensors**

All Types (e.g. infrared, ultrasonic)	\$20.00 per sensor
---------------------------------------	--------------------

# Feedback



## HAWAI'I ISLAND

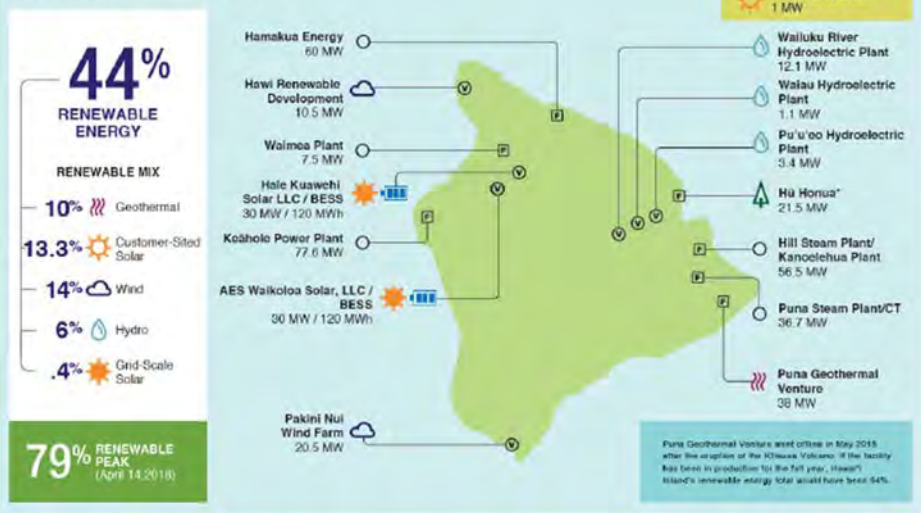



# Mahalo!



Hawaiian Electric  
Maul Electric  
Hawai'i Electric Light

**DRAFT**  
**REQUEST FOR PROPOSALS**  
**FOR**  
**NORTH KOHALA**  
**ENERGY STORAGE**  
**ISLAND OF HAWAI‘I**

OCTOBER 29, 2021

Docket No. TBD

*Appendix L – Energy Storage Services Agreement*

**NOTE: Please refer to Exhibit 5 of this October 29, 2021 filing for the Draft Model Energy Storage Services Agreement**



**Hawai'i  
Electric  
Light**

**DRAFT**  
**REQUEST FOR PROPOSALS**  
**FOR**  
**NORTH KOHALA**  
**ENERGY STORAGE**  
**ISLAND OF HAWAI‘I**

OCTOBER 29, 2021

Docket No. TBD

*Appendix M – RESERVED*

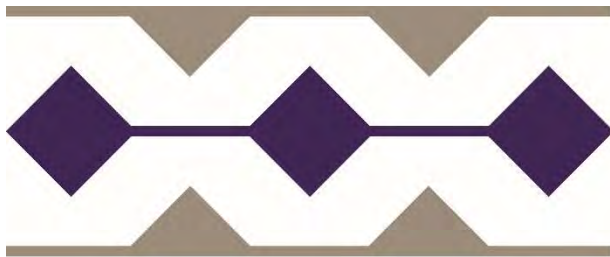

**Hawai'i  
Electric  
Light**

**DRAFT**  
**REQUEST FOR PROPOSALS**  
**FOR**  
**NORTH KOHALA**  
**ENERGY STORAGE**  
**ISLAND OF HAWAI‘I**

OCTOBER 29, 2021

Docket No. TBD

*Appendix N – RESERVED*



**Hawai'i  
Electric  
Light**

**DRAFT**

**REQUEST FOR PROPOSALS**

**FOR**

**NORTH KOHALA**

**ENERGY STORAGE**

**ISLAND OF HAWAI‘I**

OCTOBER 29, 2021

Docket No. TBD

*Appendix O – Functional Requirements*



**Hawai‘i  
Electric  
Light**

## **Table of Contents**

1.	Project Overview.....	3
1.1	BESS Location, Interconnection, and Demarcation.....	3
1.2	Communications Requirements and Existing Infrastructure Capability.....	4
2.	Microgrid Configurations and Transitions .....	5
2.1	Configuration 1: “North Kohala 34kV Microgrid” .....	5
2.1.1	Configuration 1: Planned Transition .....	5
2.1.2	Configuration 1: Unplanned Transition.....	5
2.2	Configuration 2: “Hawi Microgrid” .....	5
2.2.1	Configuration 2: Planned Transition .....	5
2.2.2	Configuration 2: Unplanned Transition .....	5
2.3	Black Start .....	5
2.3.1	Configuration 1: Unplanned Transition: Black Start Method 1: “Energize All” .....	5
2.3.2	Configuration 1: Unplanned Transition: Black Start Method 2: “Energize Main Power Transformers Then Loads” .....	6
2.3.3	Configuration 2: Unplanned Transition: Black Start Method 1: “Energize All” .....	6
2.3.4	Configuration 2: Unplanned Transition: Black Start Method 2: “Energize Main Power Transformers Then Loads” .....	6
2.4	Transition Back to Grid Connected: .....	6
2.5	Planned work on 34kV segments within the North Kohala 34kV Microgrid.....	6
2.6	Distribution Circuit Ties .....	6
3.	Normal Operation and BESS Operation when Grid Connected.....	6
3.1	Normal Operation.....	6
3.2	BESS Operation when Grid Connected .....	6
3.3	No Additional Contracted Services from the BESS .....	7
4.	Grid Following and Grid Forming Capability (for Inverter Based Resources).....	7
4.1	Grid Following.....	7
4.2	Grid Forming.....	7
4.3	BESS Mode of Operation.....	7
5.	Power System Protection.....	7
5.1	When Grid Connected .....	7
5.2	When Islanded .....	7
5.2.1	New Hawi 34kV Bus .....	7
5.2.2	34kV Line Segment.....	8
5.2.3	Maliu Ridge and Halaula Substation Main Power Transformers and Distribution Busses .....	8

- 5.2.4 Distribution Feeder Protection..... 8
- 5.2.5 BESS Protection ..... 8
- 5.3 Applying Alternate Settings Between Grid Connected and Islanded Operation ..... 8
- 6. Distributed Energy Resource (DER)..... 8
  - 6.1 Existing DER..... 8
    - 6.1.1 Need for BESS to consume energy when in Islanded mode ..... 8
  - 6.2 DER as a Microgrid Capacity Grid Service..... 8

## 1. Project Overview

The North Kohala Reliability Project will be designed to allow a segment of the North Kohala 34.5kV system including the Maliu Ridge, Halaula, and Hawi distribution substations to be operated safely and reliably as a microgrid isolated from the bulk Hawaii Electric Light (Company) power system utilizing a Battery Energy Storage System ("BESS"). The Hawi Renewable Development (HRD) wind farm located on the same radial segment of the Hawaii Electric Light power system will not be expected to operate in the microgrid island due to its size in comparison to the size of the microgrid, the controller complexity required to enable such operation, and the legacy of equipment used at the site. Further, an additional smaller microgrid allowing operation of just the Hawi Substation islanded independent of the 34kV system, utilizing the same BESS resource and interconnection equipment, is expected.

### 1.1 BESS Location, Interconnection, and Demarcation

The Company plans to acquire approximately 1.2 acres of land adjacent to the existing Hawi Distribution Substation ("Land") for siting and interconnecting the BESS. The Land will be provided for the BESS developer to install the BESS. The Land includes the 34kV line tap where the Hawi Distribution Substation is connected and where additional microgrid interconnection equipment would be expected to be installed. The BESS provider will be expected to provide all equipment on the BESS side of the BESS 34kV breaker including the BESS 34kV breaker. The Company will be responsible for all equipment on the line side of the BESS 34kV breaker including but not limited to: the microgrid controller, the Hawi Isolation Breaker, and the Hawi Substation 34kV breaker; as well as other enabling equipment beyond the Hawi Interconnection including but not limited to the Maliu Ridge Isolation Switch, fault indicators, line differential relays, and any additional PTs and CTs needed at the existing sites. A Conceptual SLD of the microgrid area depicting the above-described equipment is provided in Figure 1 below.

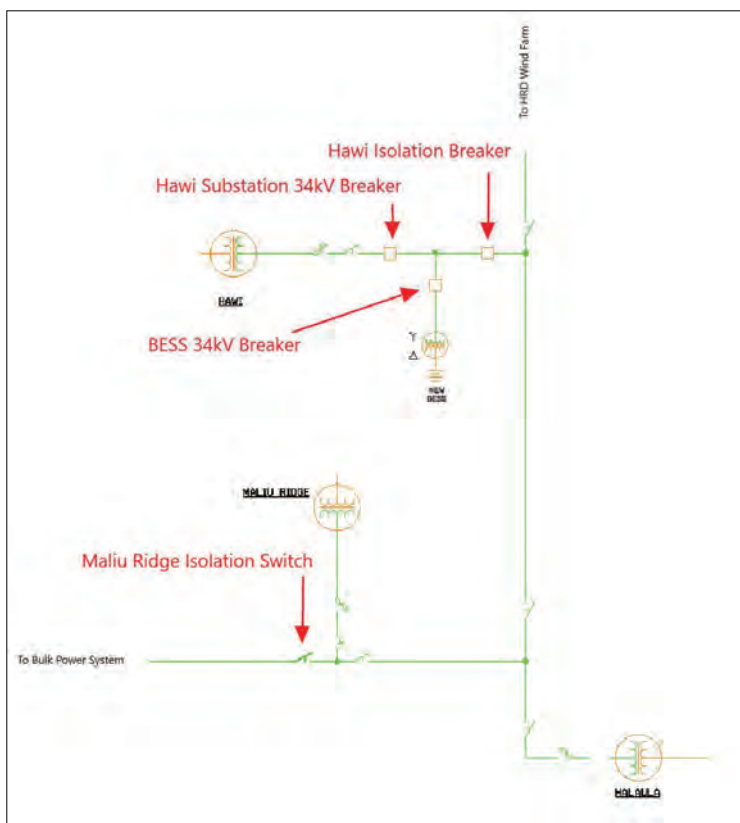

Figure 1. Conceptual SLD depicting the North Kohala Microgrid area and locations of equipment of interest.

### 1.2 Communications Requirements and Existing Infrastructure Capability

The Company will be responsible for all required inter microgrid communications links and communications links external to the microgrid utilizing the existing Company network infrastructure in the area. Details of how the BESS will communicate to the microgrid controller and the existing SCADA system will be established in more detailed design phases, but in general the BESS communications capability should be prepared to support a variety of possible hardware and protocol interfaces for ease of integration (i.e. fiber, copper, serial, IP, etc.). The interface between the BESS communication system and the Company communication system will be achieved in a dedicated demarcation cabinet or acceptable equivalent.

An automation architecture diagram to depict the expected automation of the microgrid controller and devices it controls will be developed as part of the more detailed design. The automation architecture diagram will include decision blocks where manual controls are expected.

## 2. Microgrid Configurations and Transitions

The North Kohala microgrid is being designed to operate in two distinct islanded configurations.

### 2.1 Configuration 1: "North Kohala 34kV Microgrid"

This is the preferred configuration of the microgrid when system conditions allow (i.e. fault external to the 34 kV microgrid area). In this configuration the point of isolation from the larger power system will be at the Maliu Ridge Isolation Switch located near Maliu Ridge Distribution Substation and on the



Waimea side of the Maliau Ridge substation 34kV tap such that the 34kV system between the Maliau Ridge, Halaula and Hawi substations is used to serve those stations in the microgrid.

Transitions to islanded operation in this configuration should include:

#### **2.1.1 Configuration 1: Planned Transition**

Upon a control signal from the system operator to initiate the transition to islanded operation, the microgrid will balance the power flow at the point of isolation in preparation for the isolation switch opening to achieve islanded operation. The actual operation of the isolation switch should be designed to be triggered automatically by the microgrid controller when conditions are met or manually by the system operator should manual operation be preferred or required.

#### **2.1.2 Configuration 1: Unplanned Transition**

Upon a sustained fault being detected and isolated by the Waimea and Hawi Renewable Development (HRD) 34kV breakers; the microgrid controller and system operator should be informed of the fault location. If the fault location is determined to be in the segment of line between Waimea and the Maliau Ridge Isolation Switch the Maliau Ridge Isolation Switch is to be opened by the microgrid controller to isolate the microgrid area from the fault and allow for restoration. Automation of the unplanned transition is the preferred design, but system operators can also be trained to perform steps if manual operations are required. The details of automation versus manual operations can be established in more detailed design stages and may be influenced by existing communications infrastructure and work practices.

#### **2.2 Configuration 2: "Hawi Microgrid"**

The Hawi Microgrid is an alternative configuration of the microgrid islanded area expected to be utilized only if system conditions do not allow for operation of the North Kohala 34kV Microgrid (i.e. fault internal to the 34 kV Microgrid). In the Hawi Microgrid configuration the point of isolation from the larger power system is expected to be at the Hawi Tap Breaker located on the 34kV tap to the Hawi substation such that the 34kV system between the Maliau Ridge, Halaula and Hawi will remain de-energized while Hawi is able to be energized through a very small segment of 34kV bus/line between the BESS and the Hawi distribution substation main power transformer.

Transitions to island in this configuration should include:

#### **2.2.1 Configuration 2: Planned Transition**

A planned transition to this configuration is not expected as the Hawi Microgrid is not expected to be leveraged for planned outages at this time. Should a need to operate in this configuration for planned outages be identified in future work the planned transition to this configuration should be similar to that described for the North Kohala 34kV Microgrid configuration but using the Hawi Tap Breaker for isolation rather than the Maliau Ridge Isolation Switch, and would need to be commanded through a separate SCADA point than the North Kohala 34kV Microgrid to distinguish the expected islanding configuration for the microgrid controller to transition to.

#### **2.2.2 Configuration 2: Unplanned Transition**

Upon a fault being detected and isolated by the Waimea and Hawi Renewable Development (HRD) 34kV breakers (the line will attempt a single reclose of the Waimea breaker in an attempt to restore the line after temporary faults); the microgrid controller and system operator should be informed of the fault location. Existing relaying technology provides estimated fault location based on impedance-based measurements, but fault indicators around the Maliau Ridge Isolation Switch may be a necessary improvement for accurate fault location in this application. If the fault location is determined to be in the segment of line between the Maliau Ridge Isolation Switch and the Hawi Isolation Breaker, the Hawi Isolation Breaker is to be opened to isolate the Hawi Microgrid area from the fault and allow for restoration of the Hawi loads. Automation of the unplanned transition is the preferred design, but system operators can also be trained to perform steps if manual operations are required. The details of automation versus manual operations can be established in more detailed design stages and can be influenced by existing communications infrastructure and work practices.

#### **2.3 Black Start**

It is required that the BESS be capable of black start, that is self-starting in the absence of a grid connection, but only in the designed microgrid island mode and is not required as a "cranking path" to facilitate the starting of other grid-connected generators. The black start energization of the North Kohala 34kV Microgrid or Hawi Microgrid should be achieved in a controlled method that ensures the BESS remains in operation for all transformer energizations and load additions and minimizes observable power quality issues for customers connected in the microgrid as transformers and loads are energized.

#### **2.3.1 Configuration 1: Unplanned Transition: Black Start Method 1: "Energize All"**

The preferred method to start the North Kohala 34kV Microgrid after an Unplanned Outage of the 34kV line ("Black Start Method") is by energizing all the islanded transformers and loads in a single breaker closure of the BESS such that all utility customers expected to be energized by the BESS are restored power simultaneously and are not exposed to subsequent transformer and load additions which are likely to cause a noticeable voltage flicker. The BESS capability to support this mode of energization will need to be validated through detailed resource dynamics and transformer and load energization modeling.

#### **2.3.2 Configuration 1: Unplanned Transition: Black Start Method 2: "Energize Main Power Transformers Then Loads"**

This method for black start of the North Kohala 34kV Microgrid would allow energizing all the islanded transformers with the utility customer loads disconnected and loads can be added in single feeder segments after the substation main power transformers are energized. The energization of the transformers could be achieved in a single breaker closure of the BESS such that all islanded transformers are restored to rated line voltage simultaneously or can be done in a method of controlled voltage increase to minimize inrush if the BESS supports such an energization method and if such a method would be preferred by the BESS. The BESS capability to support this mode of energization will need to be validated through detailed resource dynamics and transformer energization modeling. Further the subsequent energizations of the feeders' cold load and the power quality effect that has on already connected customers would need to be studied to ensure power quality is acceptable for load additions and can be supported by the BESS.

#### **2.3.3 Configuration 2: Unplanned Transition: Black Start Method 1: "Energize All"**

The preferred method to black start the Hawi Microgrid is by energizing the Hawi distribution main power transformer and loads in a single breaker closure of the BESS such that all islanded customers are restored simultaneously and are not exposed to subsequent load additions which could cause a noticeable voltage flicker. The BESS capability to support this mode of energization will need to be validated through detailed resource dynamics and transformer and load energization modeling.

#### **2.3.4 Configuration 2: Unplanned Transition: Black Start Method 2: "Energize Main Power Transformers Then Loads"**

This method for black start of the Hawi Microgrid would allow energizing the Hawi distribution substation main power transformer with the customer loads disconnected and loads can be added in single feeder segments after the substation main power transformer is energized. The energization of the transformer could be achieved in a single breaker closure of the BESS such that transformer is restored to rated line voltage in a single breaker operation or can be done in a method of controlled voltage increase to minimize inrush if the resource supports such an energization method and if such a method would be preferred by the BESS. The BESS capability to support this mode of energization will need to be validated through detailed resource dynamics and

transformer energization modeling. Further the subsequent energizations of the feeders' cold load and the power quality effect that has on already connected customers would need to be studied to ensure power quality is acceptable for load additions and can be supported by the BESS.

#### **2.4 Transition Back to Grid Connected:**

The 34kV grid connection is expected to be restored through manual switching up to the point of isolation (Maliu Ridge Isolation Switch or Hawi Tap Breaker). Once the grid connection is restored up to the point of isolation the re-connection of the microgrid to the grid is expected to be initiated through a command from SCADA. Once the control signal to reconnect the microgrid to the grid is received the microgrid controller will verify the grid connection is energized (acceptable voltage and frequency), the BESS will synchronize the microgrid voltage and frequency to grid voltage and frequency and when acceptably synchronized will command the microgrid isolation switch or breaker to close.

#### **2.5 Planned work on 34kV segments within the North Kohala 34kV Microgrid**

At this time the majority of planned work is expected to occur between the Waimea Substation and the Maliu Ridge Isolation Switch such that the North Kohala 34kV Microgrid will be able to support all the loads that would be isolated. If in future years a need for planned work is expected on 34kV segments within the North Kohala 34kV Microgrid area those configurations would be investigated when the need is identified.

The preferred option to facilitate 34kV work within the North Kohala 34kV Microgrid will be established as the need is identified and in coordination with work schedules and practices. Additional studies to ensure safe and reliable operation in the alternate configurations will be conducted as the need is identified to support the operations and work.

#### **2.6 Distribution Circuit Ties**

To reduce complexity and the number of studies that would need to be conducted, the North Kohala 34kV Microgrid and Hawi Microgrid configurations will not consider for operation with distribution circuits within the microgrid tied and/or loads transferred. If there are circuit exceptions (circuits within the microgrid are tied or offloaded) the microgrid will not be able to operate until the configuration can be studied to ensure adequate safety and power quality in the specific configuration. Circuits within the microgrid should be restored to a non-exception status ahead of operating them in the microgrid.

### **3. Normal Operation and BESS Operation when Grid Connected**

#### **3.1 Normal Operation**

In normal operation the 34.5kV sub-transmission line from Waimea to Maliu Ridge substation ("3300 line") supplies power to the North Kohala area via the Maliu Ridge, Halaula, and Hawi distribution substations, and allows export from the HRD wind farm.

#### **3.2 BESS Operation when Grid Connected**

When the BESS is grid connected it is expected to retain its full energy capacity in preparation for any unplanned or planned outages of the 34kV line. The restoration of energy to the BESS (charging of the BESS) is expected to be achieved through a setpoint control from SCADA and is only expected to occur when under SCADA control. The potential for the BESS to regulate voltage when grid connected will need to be studied in detail to ensure no adverse controller interactions are created between the resource and the existing HRD wind farm which also has provision for voltage regulation at its 34kV point of interconnection. If voltage regulation from the BESS is found to be favorable; the BESS will be expected to regulate voltage at its 34kV terminals through provision of reactive power to a voltage setpoint control from SCADA to the extent it can when not generating (zero active power flow or consuming energy).

#### **3.3 No Additional Contracted Services from the BESS**

The BESS is expected to be used exclusively by and dedicated to the North Kohala Microgrid. It is not expected to provide any capacity or energy dependent ancillary services to the grid when grid connected as this will conflict with its primary purpose of supporting islanded microgrid operation for extended outages of the 34kV line. Further the 69-34kV transformation capacity at the Waimea Substation is completely allocated to the capacity of the HRD wind farm and so any service when grid connected would need to be coordinated with the output of the wind farm to ensure no overloads occur. This additional complexity is not expected to be worth the small potential incremental benefit of utilizing this BESS for grid capacity or energy in addition to those services conflicting with the primary purpose as a North Kohala Reliability Resource.

The BESS will be considered for a contingency frequency response service that could be triggered in response to a frequency deviation outside of a deadband to immediately stop consuming energy if consuming energy at the time of an underfrequency event or immediately start consuming energy if there is capacity to consume energy during an overfrequency event. The response of this service would be aligned with the FFR-1 grid service procured for the Island of Hawaii and described in greater detail in the *Request for Proposals for Delivery of Grid Services from Customer-Sited Distributed Energy Resources for the Islands of O'ahu, Maui & Hawaii*<sup>1</sup>. No specific allocation of capacity to this service is expected and no additional cost for this service should be contemplated as it will be enacted only when the conditions for it to operate are met and it would only be supplemental to the primary use case as the North Kohala Reliability Resource. This frequency response service should be able to be enabled and disabled through SCADA control and should only be allowed to be enabled when grid connected.

### **4. Grid Following and Grid Forming Capability (for Inverter Based Resources)**

#### **4.1 Grid Following (GFL)**

Grid Following is defined as follows: An inverter-based resource that relies on fast synchronization with the external grid in order to tightly control the inverter's active and reactive current outputs. If these inverters are unable to remain synchronized effectively during grid events or under challenging network conditions, they are unable to maintain controlled, stable output. Advanced version of these devices (Advanced Inverters) can provide grid supporting functions such as: voltage and frequency ride-through, volt-VAR, frequency-Watt, volt-watt, etc.; when they are able to remain synchronized.

#### **4.2 Grid Forming (GFM)**

Grid Forming is defined as follows: GFM controls set an internal voltage waveform reference such that an inverter with the GFM control shall be able to synchronize with the grid and regulate active and reactive power generation appropriately, regardless of the grid's strength, or operate independently of other generation. An inverter with GFM control shall immediately respond to grid disturbances to support stability of the grid and maintain its own control stability during the system disturbances.

#### **4.3 Microgrid Resource Mode of Operation**

The BESS will be required to be capable of operating in a Grid Forming mode when grid connected and when islanded to ensure a seamless transition from grid connected to islanded and back. The BESS when islanded will need to operate in a Grid Forming isochronous frequency control mode to control voltage and frequency in the microgrid in the absence of any other synchronous or frequency and voltage controlling resource. The BESS can remain in Grid Forming mode while grid connected but would be expected to operate on a DROOP primary frequency response and not as an isochronous source, or

<sup>1</sup> [https://www.hawaiianelectric.com/documents/clean\\_energy\\_hawaii/selling\\_power\\_to\\_the\\_utility/competitive\\_bidding/20190822\\_final\\_stage\\_2\\_rfp\\_book\\_7.pdf](https://www.hawaiianelectric.com/documents/clean_energy_hawaii/selling_power_to_the_utility/competitive_bidding/20190822_final_stage_2_rfp_book_7.pdf) (reference pdf pages 235-237)

could be switched to a Grid Following mode of operation and provide the grid support functions it is capable of in the Grid Following mode. The mode of operation when grid connected and not transitioning to islanded will need to be studied to identify the preferred mode of operation when grid connected.

## **5. Power System Protection**

### **5.1 When Grid Connected**

When the microgrid is grid connected the existing power system protection schemes are expected to operate as designed.

### **5.2 When Islanded**

Both the 34kV and Hawi Microgrid configurations will need to be studied in detail to ensure power system protection is safe and reliable for all desired configurations; and should be designed to be selective and secure to the extent achievable in all desired configurations. A model representing the detailed BESS behavior during fault conditions will need to be used to study the detailed operations of protection devices. The BESS model for this protection study should include expected limits of the BESS (ride-through, current, imbalance, etc.) so those can be avoided by power system protection systems operating ahead of those limits to still retain selectivity in the microgrid to the extent the BESS can support.

#### **5.2.1 Hawi 34kV Bus**

The BESS is expected to be interconnected to the system at a new 34kV bus created between a new BESS 34kV breaker, a new Hawi Isolation Breaker, and a new Hawi Substation 34kV breaker ("New Hawi 34kV Bus"). This segment of 34kV bus is expected to be protected utilizing current differential protection.

#### **5.2.2 BESS Protection**

The BESS will be expected to be designed with appropriate protection of the equipment on the BESS side of the BESS 34kV breaker. When grid connected the BESS protection scheme can rely on short circuit current being provided from the system. When islanded the BESS protection will need to be coordinated to the extent possible with the protection schemes described above for islanded operation. Islanded operation protection coordination will be investigated and informed in the detailed protection study. BESS protection when grid connected will also be validated as part of the detailed protection study.

### **5.3 Applying Alternate Settings Between Grid Connected and Islanded Operation**

If any power system protection settings are expected to need to be changed between grid connected and islanded operation the protective relays will be pre-programmed with the appropriate settings for each configuration and the microgrid controller would inform the relays of which settings are to be active based on the expected microgrid configuration. The change in settings are expected to be applied ahead of operating as a microgrid to ensure safety at all times, even if it sacrifices selectivity during the transition between grid connected and islanded operation.

## **6. Distributed Energy Resource (DER)**

### **6.1 Existing DER**

All existing DER systems interconnected to the circuits in the microgrid area will be expected to be capable of operating when the microgrid is in an islanded configuration. Existing DER is expected to contribute to the energy capacity of the microgrid in the same form it contributes when grid connected under the existing agreement for interconnection. The BESS energy and power capacity requirements were derived with inclusion of existing DER contributions of energy into the islanded microgrid.

#### **6.1.1 Need for BESS to consume energy when in Islanded mode**

At existing levels of DER deployment in the microgrid area DER export is never more than the gross load in the area and therefore it is not envisioned that the BESS would ever need to consume energy when in islanded mode. Further, all future DER programs with capacity remaining for interconnection have a requirement for advanced inverter functions such as frequency-watt to aid in stabilizing frequency when high, as well as an ability to be externally controlled by the utility for excess energy conditions; so if future deployment of DER in the area poses an excess energy condition when in islanded mode a means to leverage the external utility control of DER can be pursued. Also given the planned nature of this microgrid for most of its operations, should a potential excess energy condition be predicted the planned work could be manipulated to try to reconnect the microgrid ahead of the excess energy condition being reached.

### **6.2 DER as a Microgrid Capacity Grid Service**

Given stakeholder interest to allow for DER participation in a potential "Microgrid Capacity Grid Service", the BESS sizing can contemplate an option for this potential service to be provided by DERs and the capacity acquired through this service would supplement the sizing of the BESS. A DER provided capacity service is not expected to eliminate the need for a BESS given the need for a "Grid Forming" source within the microgrid to allow for "Grid Following" DER to operate. The DER provided service would be expected to be competitively procured in conjunction with a competitive sizing of the BESS. If a DER grid service is being proposed the details of monitoring and control required of the DER to the microgrid controller for reliable cost-effective operation of the BESS in coordination with the Microgrid Capacity Grid Service DER will need to be established. The proposed design and cost to build such an interface between DER and the microgrid controller would be expected to be provided in a proposal offering a DER service solution for proper comparison of costs.

## EXHIBIT 5

Draft Model Energy Storage Services Agreement (“ESSA”)

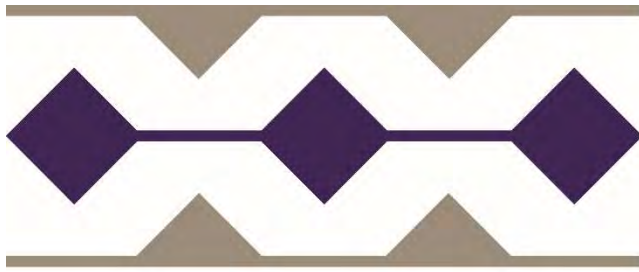

**Hawai'i  
Electric  
Light**

*Draft Model  
Energy Storage Services  
Agreement*

*October 29, 2021 Version*

**This document indicates, for information purposes only, the terms and conditions that may be negotiated in a contract for the sale of energy storage services to be executed by Hawai'i Electric Light Company, Inc. The terms and conditions that may be offered by Hawai'i Electric Light Company, Inc. in an energy storage services agreement may be modified to reflect factors such as different storage technologies, project specifics, changes in applicable rules, guidance from the Public Utilities Commission in proceedings concerning the approval or negotiation of such energy storage services agreements, results of an interconnection requirements study and other negotiated terms and conditions. This document also assumes that the proposed facility will be a battery energy storage system. If a proposal containing technology other than a battery for the energy storage system is selected for the RFP's final award group, replacement provisions accounting for such differing technology will need to be developed for the energy storage services agreement for such project proposal.**

**[NOTE: TEXT WITHIN THIS DOCUMENT THAT APPEARS IN BOLD AND/OR BRACKETS INDICATES A PROVISION THAT MAY REQUIRE REVISION TO CONFORM TO A SPECIFIC PROJECT.]**

**Table of Contents**

**ARTICLE 1** PARALLEL OPERATION .....2

**ARTICLE 2** FACILITY OWNED AND OPERATED BY SELLER .....3

**ARTICLE 3** TERM OF THE AGREEMENT .....4

**ARTICLE 4** COMPENSATION; PERFORMANCE LEVELS .....6

**ARTICLE 5** BILLING AND PAYMENT .....11

**ARTICLE 6** EVENTS OF DEFAULT; REMEDIES; TERMINATION.....14

**ARTICLE 7** COMPANY-OWNED INTERCONNECTION FACILITIES.....18

**ARTICLE 8** CHARGING ENERGY OBLIGATIONS.....19

**ARTICLE 9** METERING; MONITORING AND COMMUNICATIONS.....25

**ARTICLE 10** GOVERNMENTAL APPROVALS AND LAND RIGHTS .....28

**ARTICLE 11** CONSTRUCTION PERIOD AND MILESTONES .....30

**ARTICLE 12** DISPATCHING AND CHARGING THE FACILITY; SCHEDULING .....34

**ARTICLE 13** FACILITY OPERATIONS, MAINTENANCE AND REPAIR .....30

**ARTICLE 14** CREDIT ASSURANCE AND SECURITY .....38

**ARTICLE 15** SALE AND ASSIGNMENT .....42

**ARTICLE 16** PERSONNEL AND SYSTEM SAFETY .....38

**ARTICLE 17** FORCE MAJEURE.....39

**ARTICLE 18** REPRESENTATIONS AND WARRANTIES .....48

**ARTICLE 19** LIMITATIONS.....43

**ARTICLE 20** INDEMNIFICATION.....50

**ARTICLE 21** INSURANCE .....47

**ARTICLE 22** REVISIONS TO PERFORMANCE STANDARDS.....50

**ARTICLE 23** FINANCIAL COMPLIANCE.....55

**ARTICLE 24** REGULATORY APPROVAL .....58

**ARTICLE 25** EQUAL EMPLOYMENT OPPORTUNITY .....62

<b>ARTICLE 26</b> DISPUTE RESOLUTION .....	63
<b>ARTICLE 27</b> MISCELLANEOUS .....	64
<b>SCHEDULE OF DEFINED TERMS</b> .....	SCHEDULE OF DEFINED TERMS-1
<b>ATTACHMENT A</b> DESCRIPTION OF STORAGE FACILITY.....	A-1
<b>EXHIBIT A-1</b> GOOD STANDING CERTIFICATES.....	A-5
<b>EXHIBIT A-2</b> OWNERSHIP STRUCTURES .....	A-6
<b>ATTACHMENT B</b> FACILITY OWNED BY SELLER .....	B-1
<b>EXHIBIT B-1</b> MODELING REQUIREMENTS .....	B-40
<b>EXHIBIT B-2</b> CAPABILITY CURVE(S).....	B-42
<b>ATTACHMENT C</b> RESERVED .....	C-1
<b>ATTACHMENT D</b> CONSULTANTS LIST .....	D-1
<b>ATTACHMENT E</b> SINGLE-LINE DRAWING AND INTERFACE BLOCK DIAGRAM .....	E-1
<b>ATTACHMENT F</b> RELAY LIST AND TRIP SCHEME .....	F-1
<b>ATTACHMENT G</b> COMPANY-OWNED INTERCONNECTION FACILITIES .....	G-1
<b>ATTACHMENT H</b> RESERVED .....	H-1
<b>ATTACHMENT I</b> RESERVED .....	I-1
<b>ATTACHMENT J</b> ADJUSTMENT TO LUMP SUM PAYMENT.....	J-1
<b>ATTACHMENT K</b> GUARANTEED PROJECT MILESTONES.....	K-1
<b>ATTACHMENT K-1</b> SELLER'S CONDITIONS PRECEDENT AND COMPANY MILESTONES .....	K-2
<b>ATTACHMENT L</b> REPORTING MILESTONES.....	L-1
<b>ATTACHMENT M</b> FORM OF LETTER OF CREDIT.....	M-1
<b>ATTACHMENT N</b> ACCEPTANCE TEST GENERAL CRITERIA .....	N-1
<b>ATTACHMENT O</b> CONTROL SYSTEM ACCEPTANCE TEST CRITERIA .....	O-1
<b>ATTACHMENT P</b> SALE OF FACILITY BY SELLER .....	P-1
<b>ATTACHMENT Q</b> REQUIRED INSURANCE.....	Q-1
<b>ATTACHMENT R</b> FORM OF MONTHLY PROGRESS REPORT .....	R-1



**ATTACHMENT S** ANNUAL REPORTING AND DISPUTE RESOLUTION BY INDEPENDENT EVALUATION ..... S-1

**ATTACHMENT T** CAPACITY RATIO AND RTE RATIO ..... T-1

**ATTACHMENT U** MEASURED AVAILABILITY ..... U-1

**ATTACHMENT V** RESERVED ..... V-1

**ATTACHMENT W** SUMMARY OF MAINTENANCE AND INSPECTION PERFORMED IN PRIOR..... W-1

**ATTACHMENT X** COMPANY-CONTROLLED SITE..... X-1

## **ENERGY STORAGE SERVICES AGREEMENT**

This Energy Storage Services Agreement, together with the Attachments (collectively, this “**Agreement**”) is made and entered into as of this [\_\_\_\_] day of [Month], [Year] (“**Execution Date**”) by **HAWAI’I ELECTRIC LIGHT COMPANY, INC.**, a Hawai’i corporation (“**Company**,” and [**SELLER**], a [Seller’s business registration] (“**Seller**”). Company and Seller are sometimes referred to herein individually as a “**Party**” and jointly as the “**Parties**.” Capitalized terms used in this Agreement and not otherwise defined in the context in which they first appear are defined in the Schedule of Defined Terms.

### **RECITALS**

WHEREAS, Company is an operating electric public utility on the Island of Hawai’i, subject to the Hawai’i Public Utilities Law (Hawai’i Revised Statutes, Chapter 269) and the rules and regulations of the Hawai’i Public Utilities Commission (the “**PUC**”); and

WHEREAS, the Company System is operated as an independent power grid and must both maximize system reliability for its customers by ensuring that sufficient generation is available and meet the requirements for voltage stability, frequency stability, and reliability standards; and

WHEREAS, Seller desires to build, own and operate a safe, reliable and operationally flexible battery energy storage system for integration with, and as part of, a microgrid controller system (“**Microgrid**”) to provide the Company System with those benefits and services associated with the Energy Storage Services, as defined herein; and

WHEREAS, Seller understands the need to use all commercially reasonable efforts to maximize the overall reliability of the Company System; and

WHEREAS, the Facility is proposed to be located at the Company-controlled Site in Hawi, County of Hawai’i, State of Hawai’i, as more fully described in **Attachment A** (Description of Storage Facility) and **Attachment B** (Facility Owned by Seller) attached hereto and made a part hereof; and

WHEREAS, Seller desires to sell to Company, and Company agrees to purchase upon the terms and conditions set forth herein, the availability of the Energy Storage Services provided by the Facility;

NOW, THEREFORE, in consideration of the premises and the respective promises herein, Company and Seller hereby agree as follows:

## **ARTICLE 1**

### **PARALLEL OPERATION**

In connection with its operation of the Facility to provide the Energy Storage Services to Company for integration with, and as part of, a Microgrid, Seller shall comply in all respects with any and all requirements and obligations to enable the interconnection and parallel operation of the Facility with the Company System; provided, however, that such interconnection and parallel operation (a) shall not (i) adversely affect Company's property or the operations of its customers and customers' property; (ii) present safety hazards to the Company System, Company's property or employees or Company's customers or the customers' property or employees; or (iii) otherwise fail to comply with any applicable Laws, Governmental Approvals, Company's interconnection requirements or this Agreement; and (b) shall be contingent upon the satisfactory completion, as determined solely by Company, of the Acceptance Test and, to the extent applicable, the Control System Acceptance Test, in accordance with Good Engineering and Operating Practices.

## **ARTICLE 2**

### **FACILITY OWNED AND OPERATED BY SELLER**

#### **2.1. Facility Owned and Operated by Seller.**

Seller agrees to design, furnish, install, operate and maintain the Facility in accordance with all applicable Laws, Governmental Approvals, Good Engineering and Operating Practices and the terms and conditions of this Agreement. After the Commercial Operations Date, Seller agrees that no changes or additions to the Facility shall be made without prior written approval by Company and amendment to the Agreement unless such changes or additions to the Facility could not reasonably be expected to have a material effect on the assumptions used in performing the IRS.

#### **2.2. Allowed Capacity.**

The net instantaneous MW output from the Facility may exceed the Contract Capacity. The Company may dispatch up to the Rated Active Power Capacity in accordance with **Section 12** (Dispatching and Charging the Facility; Scheduling). Company may limit the net instantaneous MW output of the Facility pursuant to, but not limited to, **Article 12** (Dispatching and Charging the Facility; Scheduling), **Article 16** (Personnel and System Safety), **Attachment B** (Facility Owned by Seller) and Good Engineering and Operating Practices. Company shall not be required to pay for any Discharge Energy.

#### **2.3. Interconnection Requirements Study.**

If this Agreement is executed prior to completion of the Interconnection Requirements Study, then following the completion of the IRS:

(a) The Parties shall, no later than the ESSA Amendment Deadline, execute a formal amendment to this Agreement substituting new versions of **Attachment B** (Facility Owned by Seller), **Attachment E** (Single-Line Drawing and Interface Block Diagram), **Attachment F** (Relay List and Trip Scheme), **Attachment G** (Company-Owned Interconnection Facilities), **Attachment K** (Guaranteed Project Milestones), **Attachment K-1** (Seller's Conditions Precedent and Company Milestones) and **Attachment L** (Reporting Milestones) (the “**Interconnection Requirements Amendment**”) to reflect the results of the IRS; or

(b) This Agreement may be declared null and void (i) by either Party upon written notice to the other Party if the Interconnection Requirements Amendment is not executed by the ESSA Amendment Deadline; or (ii) by Seller upon written notice delivered to Company no later than the Termination Deadline.

## **ARTICLE 3**

### **TERM OF THE AGREEMENT**

#### **3.1. Term**

Subject to **Section 3.3** (Effectiveness of Certain Obligations), the initial term of this Agreement shall commence upon the Execution Date, and, unless earlier terminated as provided herein, shall remain in effect for ten (10) Contract Years following the Commercial Operations Date (the “**Initial Term**”). This Agreement shall automatically terminate upon expiration of the Initial Term. If the Parties desire, the Parties may negotiate terms and conditions of an extension term (“**Extended Term**”), including reduced contract pricing in recognition that Seller will have recovered its capital and financing costs, which terms and conditions (a) shall be submitted to the PUC by Company for approval no later than one (1) year prior to the expiration of the Initial Term and (b) shall have no effect without PUC approval.

#### **3.2. Information Sharing and Shared Learning.**

Seller acknowledges that Company is entering into this Agreement, in part, to gain operational and market information regarding the performance, efficiency, operations, maintenance, and uses of energy storage assets as an integral part of Company’s portfolio of assets to meet its customers’ needs. Throughout the Term, Seller agrees to share such information with Company upon Company’s reasonable request, with such information to be treated by Company as confidential if Seller so requests, which will include, without limitation, design logic, and tunable parameters and values, which in total determine the technical and operational characteristics, and historical data to review operational performance.

#### **3.3. Effectiveness of Certain Obligations.**

Only **Article 2** (Facility Owned and/or Operated By Seller), this **Article 3** (Term of the Agreement); **Article 6** (Events of Default; Remedies; Termination), **Section 10.4** (Compliance With Laws), **Article 14** (Credit Assurance and Security), as it relates to Development Period Security, **Article 15** (Sale and Assignment), **Article 17** (Force Majeure), **Article 18** (Representations and Warranties), **Article 19** (Limitations), **Article 20** (Indemnification), **Article 23** (Financial Compliance), **Article 24** (Regulatory Approval), **Article 26** (Dispute Resolution), **Article 27** (Miscellaneous), and the Schedule of Defined Terms of this Agreement shall become effective on the Execution Date. Except where obligations of the Parties are explicitly stated as being effective before the Effective Date, all other portions of this Agreement shall become effective on the Effective Date.

#### **3.4. Prior to Effective Date.**

Company may, by written notice delivered prior to the Effective Date, declare the Agreement null and void if any one or more of the following conditions applies:

- (a) Seller implements a material change to the Facility (i) without following

the requirements of **Section 8(b)** of **Attachment A** (Description of Storage Facility); or (ii) in a manner inconsistent with the process established under **Section 2.3** (Interconnection Requirements Study).

**(b)** Seller is in breach of any of its representations and warranties under this Agreement, including, but not limited to, Seller's representation and warranty in **Section 18.2(c)** and **(d)** that Seller have all Land Rights and Governmental Approvals as provided therein.

**(c)** (i) Seller, subsequent to making payment to Company to pay for the IRS, requests in writing that Company stop or otherwise delay the performance of such work; or (ii) the IRS Letter Agreement is terminated pursuant to the terms thereof prior to the completion of the Interconnection Requirements Study.

### **3.5. Agreement Null and Void.**

If the Agreement is declared null and void pursuant to **Section 2.3** (Interconnection Requirements Study), **Section 3.4** (Prior to Effective Date), **Section 24.3** (Time Period for PUC Submittal Date), or **Section 24.4** (Time Period for PUC Approval), the Parties hereto shall thereafter be free of all obligations hereunder except as set forth in this **Section 3.5** (Agreement Null and Void) and **Section 14.1(b)** (Return of Development Period Security), and shall pursue no further remedies against the other. A declaration that this Agreement is null and void pursuant to **Section 2.3** (Interconnection Requirements Study), **Section 3.4** (Prior to Effective Date), **Section 24.3** (Time Period for PUC Submittal Date), or **Section 24.4** (Time Period for PUC Approval), shall not affect the following provisions, which shall remain in full force and effect: **Section 3.2** (Information Sharing and Shared Learning), **Section 3.3** (Effectiveness of Certain Obligations), this **Section 3.5** (Agreement Null and Void), **Section 23.2** (Confidentiality), **Article 26** (Dispute Resolution), **Section 27.3** (Notices), **Section 27.8** (Governing Law, Jurisdiction and Venue), **Section 27.13** (Settlement of Disputes), **Section 27.16** (Computation of Time), **Section 27.19** (No Third-Party Beneficiaries), **Section 27.20** (Hawai'i General Excise Tax), and **Section 7** (Land Restoration) of **Attachment G** (Company-Owned Interconnection Facilities). Notwithstanding the foregoing, the right of either Party to terminate the Agreement at any time upon the occurrence of any Event of Default described in **Article 6** (Events of Default; Remedies; Termination) shall remain in full force and effect.

## **ARTICLE 4 COMPENSATION; PERFORMANCE LEVELS**

### **4.1. Lump Sum Payment.**

Commencing on the Commercial Operations Date, Company shall pay to Seller a monthly Lump Sum Payment in consideration for the availability of the Facility's Energy Storage Services to respond to Company Dispatch/Charge in accordance with this Agreement. For purposes of calculating the monthly Lump Sum Payment, the monthly Lump Sum Payment shall be adjusted as more fully set forth in **Attachment J** (Adjustment to Lump Sum Payment) to this Agreement.

### **4.2. Performance Levels.**

The Facility's capability to make the Energy Storage Services available for Company Dispatch/Charge shall be assessed and evaluated with respect to the following: (a) the capability of the Facility to discharge continuously for a total energy amount equal to **22 MWh** (the "**Performance Level Rated Energy Capacity**"); (b) the capability of the Facility to provide the Rated Active Power Capacity at its expected availability rate of **98%** (the "**Performance Level Availability**"); and (c) the capability of the Facility provide its expected round trip efficiency rate of **85%** (the "**Performance Level RTE**"), which represents the lowest acceptable efficiency of the Facility for a full charge and discharge cycle with all energy to achieve the full cycle being taken from and delivered to the Point of Interconnection. Seller shall design, operate and maintain the Facility in a manner consistent with the standard of care reasonably expected of an experienced owner/operator with the desire and financial resources necessary to design, operate and maintain the Facility to achieve the Performance Levels all in accordance with Good Engineering and Operating Practices. The Performance Level Availability described in this **Article 4** (Compensation; Performance Levels) shall be interpreted consistent with the NERC GADS Data Reporting Instructions unless modified by this Agreement.

### **4.3. Performance Level Rated Energy Capacity.**

**(a) Capacity and Liquidated Damages.** During commissioning, and for each Measurement Period following the Commercial Operations Date, the Facility shall be required to achieve the Performance Level Rated Energy Capacity, as more fully set forth in **Attachment T** (Capacity Ratio and RTE Ratio) to this Agreement. For each Measurement Period for which the Facility fails to achieve the Performance Level Rated Energy Capacity, Seller shall pay, and Company shall accept, as liquidated damages for such shortfall, such amount determined pursuant to the following formula upon proper demand at the end the Measurement Period in question:

$$(100\% - \text{Capacity Ratio}) \times \text{Lump Sum Payment for the Measurement Period in question}$$

For purposes of determining liquidated damages under this **Section 4.3(a)** (Capacity and Liquidated Damages), (a) the starting and end points for the duration of the period that the Facility discharges shall be rounded to the nearest MWh, and (b) the Capacity

Ratio utilized for the calculation of damages shall be as set forth in **Attachment T** (Capacity Ratio and RTE Ratio). Each Party agrees and acknowledges that (i) the damages that Company would incur if the Seller fails to achieve the Performance Level Rated Energy Capacity for a Measurement Period would be difficult or impossible to calculate with certainty and (ii) the aforesaid liquidated damages are an appropriate approximation of such damages.

**(b) Capacity Termination Rights.** The Parties acknowledge that, although the intent of the liquidated damages payable under **Section 4.3(a)** (Capacity and Liquidated Damages) is to compensate Company for the damages that Company would incur if the Facility fails to achieve the Performance Level Rated Energy Capacity during a Measurement Period, such liquidated damages are not intended to compensate Company for the damages that Company would incur if a pattern of underperformance establishes a reasonable expectation that the Facility is likely to continue to substantially underperform the Company's expectations. Accordingly, and without limitation to Company's rights under said **Section 4.3(a)** (Capacity and Liquidated Damages), the failure of the Seller to achieve the Performance Level Rated Energy Capacity in two (2) consecutive Measurement Periods shall constitute an Event of Default under **Section 6.1(c)** of this Agreement for which Company shall have the rights (including but not limited to the termination rights) set forth in **Article 6** (Events of Default; Remedies; Termination).

#### **4.4. Performance Level Availability.**

**(a) Measured Availability and Liquidated Damages.** For each calendar month following the Commercial Operations Date, the Facility's availability ("**Measured Availability**") shall be calculated as set forth in **Attachment U** (Measured Availability). If the Measured Availability for such calendar month is less than the Performance Level Availability, Seller shall pay, and Company shall accept, as liquidated damages for such shortfall, such amount determined pursuant to the following formula upon proper demand at the end of the calendar month in question:

$$\frac{(98\% - \text{Measured Availability})}{98\%} \times \text{Lump Sum Payment for the calendar month in question}$$

Each Party agrees and acknowledges that (i) the damages that Company would incur if the Seller fails to achieve the Performance Level Availability for a calendar month would be difficult or impossible to calculate with certainty and (ii) the aforesaid liquidated damages are an appropriate approximation of such damages.

**(b) Performance Level Availability Termination Rights.** The Parties acknowledge that, although the intent of the liquidated damages payable under **Section 4.4(a)** (Measured Availability and Liquidated Damages) is to compensate Company for the damages that Company would incur if the Seller fails to achieve the Performance Level Availability for a calendar month, such liquidated damages are not intended to compensate Company for the damages that Company would incur if a pattern of underperformance establishes a reasonable expectation that the Facility is likely to continue to substantially underperform the Performance Level Availability. Accordingly, and without limitation to Company's rights under said **Section 4.4(a)**



(Measured Availability and Liquidated Damages), the failure of the Seller to either (i) achieve a Measured Availability of at least 95% for any calendar month, or (ii) limit the aggregate hours of unavailability caused by unplanned outages during the Initial Term to no more than three hundred thirty-six (336) hours shall constitute an Event of Default under **Section 6.1(d)** of this Agreement for which Company shall have the rights (including but not limited to the termination rights) set forth in **Article 6** (Events of Default; Remedies; Termination).

#### **4.5. Performance Level RTE.**

**(a) RTE and Liquidated Damages.** For each Measurement Period following the Commercial Operations Date, the Facility shall be required to achieve the Performance Level RTE, as more fully set forth in **Attachment T** (Capacity Ratio and RTE Ratio) to this Agreement. For each Measurement Period for which the Facility fails to achieve the Performance Level RTE, Seller shall pay, and Company shall accept, as liquidated damages for such shortfall, such amount to be calculated as provided in this **Section 4.5(a)** (RTE and Liquidated Damages) upon proper demand at the end of the Measurement Period in question.

For each percentage point by which the RTE Ratio is below the Performance Level RTE, Seller shall pay, and Company shall accept, liquidated damages in an amount equal to two-tenths of one percent (0.0002) of the Lump Sum Payment for the Measurement Period in question.

Each Party agrees and acknowledges that (i) the damages that Company would incur if the Seller fails to achieve the Performance Level RTE for a Measurement Period would be difficult or impossible to calculate with certainty and (ii) the aforesaid liquidated damages are an appropriate approximation of such damages.

**(b) RTE Termination Rights.** The Parties acknowledge that, although the intent of the liquidated damages payable under **Section 4.5(a)** (RTE and Liquidated Damages) is to compensate Company for the damages that Company would incur if the Facility fails to achieve the Performance Level RTE during a Measurement Period, such liquidated damages are not intended to compensate Company for the damages that Company would incur if a pattern of underperformance establishes a reasonable expectation that the Facility is likely to continue to substantially underperform the Company's expectations. Accordingly, and without limitation to Company's rights under said **Section 4.5(a)** (RTE and Liquidated Damages), if the RTE Ratio is more than three (3) percentage points below the Performance Level RTE in two (2) consecutive Measurement Periods, such failure shall constitute an Event of Default under **Section 6.1(e)** of this Agreement for which Company shall have the rights (including but not limited to the termination rights) set forth in **Article 6** (Events of Default; Remedies; Termination).

#### **4.6. Payment of Liquidated Damages for Failure to Achieve Performance Levels; Limitation on Liquidated Damages.**

**(a) Payment of Liquidated Damages.** With respect to the liquidated

damages payable under **Section 4.3(a)** (Capacity and Liquidated Damages), **Section 4.4(a)** (Measured Availability and Liquidated Damages), and **Section 4.5(a)** (RTE and Liquidated Damages) (collectively, the “**Performance Levels LDs**”), Company shall have the right, at any time on or after the LD Assessment Date for the liquidated damages in question, at Company’s option, to set-off such liquidated damages from the amounts to be paid to Seller under **Section 4.1** (Lump Sum Payment) of this Agreement or, to draw such liquidated damages from the Operating Period Security, as follows:

(i) if the Monthly Report for the calendar month in question shows a failure to achieve one or more of the Performance Levels required for such calendar month or the Measurement Period ending with such calendar month, as applicable), and Company does not submit a Notice of Disagreement with respect to such Monthly Report, Company shall have the right to set-off or draw the amount of liquidated damages owed for such failure as calculated as provided in **Section 4.3(a)** (Capacity and Liquidated Damages), **Section 4.4(a)** (Measured Availability and Liquidated Damages) and **Section 4.5(a)** (RTE and Liquidated Damages), as applicable;

(ii) in all cases in which Company submits a Notice of Disagreement for a given Monthly Report, Company shall have the right to set-off or draw all or any portion of the amount of liquidated damages for the calendar month in question and the Measurement Period ending with such calendar month, as applicable, as calculated on the basis of the shortfall(s) in the achievement of the Performance Level(s) in question, as shown in such Notice of Disagreement; and

(iii) in the event of any disagreement as to the liquidated damages owed under clause (i) above:

(A) if the amount set-off or drawn by the Company exceeds the amount of liquidated damages for such calendar month (and Measurement Period ending with such calendar month, as applicable) that are eventually found to be payable as determined under **Section 2** (Monthly Report Disagreements) of **Attachment S** (Monthly Reporting and Dispute Resolution by Independent Evaluator) to this Agreement, Company shall promptly (and in no event more than forty-five (45) Business Days from the date of such determination) repay such excess to Seller together with, unless the Parties otherwise agree in writing, interest from the date of Company’s set-off or draw until the date that such excess is repaid to Seller at the average Prime Rate for such period; and

(B) if Company does not exercise its rights to set-off or draw liquidated damages for such calendar month or Measurement Period, as applicable, or does not set-off or draw the full amount of the liquidated damages for such period eventually found to be payable as determined under **Section 2** (Monthly Report Disagreements) of **Attachment S** (Monthly Reporting and Dispute Resolution by Independent Evaluator) to this Agreement, Seller shall promptly, upon such determination as aforesaid, pay to Company the amount of liquidated damages that are found to be owing together with, unless otherwise agreed by the Parties in writing, interest on the amount of such liquidated damages that went unpaid from the applicable LD Assessment Date for such liquidated damages until the date such liquidated damages are paid to Company in full at the average Prime Rate for such

period, and Company shall have the right, at its option, to set-off such interest for the amounts to be paid to Seller under **Section 4.1** (Lump Sum Payment) of this Agreement or to draw from the Operating Period Security.

Any delay by Company in exercising its rights to set-off liquidated damages and/or interest from the amounts to be paid to Seller under **Section 4.1** (Lump Sum Payment) of this Agreement, or to draw such liquidated damages and/or interest from the Operating Period Security, shall not constitute a waiver by Company of its right to do so.

**(b) Limitation on Liquidated Damages.** Notwithstanding any other provision of this Agreement to the contrary, the aggregate liquidated damages paid by Seller during each Contract Year for the Performance Levels LDs, such payments by Seller to include but not be limited to any set-offs or draws made by Company during such Contract Year pursuant to **Section 4.6(a)** (Payment of Liquidated Damages), shall not exceed the total of the twelve (12) monthly Lump Sum Payments payable during such Contract Year pursuant to **Section 4.1** (Lump Sum Payment) and **Section 5.4** (Payment Procedures). For avoidance of doubt: A monthly Lump Sum Payment that is invoiced by Seller to Company pursuant to **Section 5.3** (Seller's Preparation of the Monthly Invoice and Monthly Report) for, e.g., the twelfth (12<sup>th</sup>) calendar month of Contract Year N but is paid during Contract Year N+1 as provided in **Section 5.4** (Payment Procedures) shall, for purposes of determining the limitation on Performance Levels LDs under this **Section 4.6(b)** (Limitation on Liquidated Damages), be included in the total of the twelve (12) monthly Lump Sum Payments payable during Contract Year N+1. As a result of the foregoing, the total of the monthly Lump Sum Payments used to establish the limitation on Performance Levels LDs for the initial Contract Year under this **Section 4.6(b)** (Limitation on Liquidated Damages) will be less than twelve (12). The Parties acknowledge that, because the monthly Lump Sum Payment is subject to adjustment (including downward adjustment) as provided in **Section 4.1** (Lump Sum Payment), it is possible that a downward adjustment in some or all of the monthly Lump Sum Payments payable during a Contract Year might cause the Performance Levels LDs paid by Seller during the course of such Contract Year to exceed the limitation on the Performance Levels LDs for such Contract Year established at the close of such Contract Year pursuant to the first sentence of this **Section 4.6(b)** (Limitation on Liquidated Damages). In such case, Company shall promptly upon the determination that the Performance Levels LDs paid during the course of such Contract Year exceeded the limitation on Performance Levels LDs for such Contract Year (and in no event more than forty-five (45) Business Days from the end of such Contract Year) repay such excess amount to Seller without interest.

## **ARTICLE 5 BILLING AND PAYMENT**

### **5.1. No Payments Prior to Commercial Operations Date.**

Company shall not be obligated to make any payment for the availability of the Facility's Energy Storage Services prior to the Commercial Operations Date.

### **5.2. Sales of Electric Energy by Company to Seller; Seller Payments.**

Sales of electric energy by Company to Seller (e.g., for Station Use) shall be governed by an applicable rate schedule filed with the PUC and not by this Agreement, except with respect to the reactive amount adjustment (if any) referred to in **Attachment B** (Facility Owned by Seller). Seller shall pay to Company (a) all amounts pursuant to **Section 9.1** (Revenue Metering Package; Station Use Metering Equipment) and **Section 9.2** (Meter Testing); (b) a monthly metering charge of \$25.00 per month, which is in addition to any charges due Company pursuant to the applicable rate schedule pursuant the preceding sentence of this **Section 5.2** (Sales of Electric Energy By Company to Seller; Seller Payments) of this Agreement; and (c) such other costs to be incurred by Company and reimbursed by Seller as set forth in this Agreement.

### **5.3. Seller's Preparation of the Monthly Invoice and Monthly Report.**

**(a) Monthly Invoice.** By the tenth (10<sup>th</sup>) Business Day of each calendar month, Seller shall submit to Company an invoice for the payment obligations incurred by Company and Seller during the preceding month pursuant to **Article 4** (Compensation; Performance Levels) and **Section 5.2** (Sales of Electric Energy by Company to Seller; Seller Payments), together with all supporting documentation and calculations reasonably necessary to evidence all amounts charged thereunder.

**(b) Monthly Report.** Commencing with the month during which the Commercial Operations Date is achieved, and for each calendar month thereafter during the Term, Seller shall prepare and provide to Company a Monthly Report within ten (10) Business Days of the following month in accordance with **Section 1** (Monthly Report) of **Attachment S** (Monthly Reporting and Dispute Resolution by Independent Evaluator) of this Agreement. Seller shall include calculations of (a) the Capacity Ratio, the RTE Ratio and the Measured Availability for the calendar month in question, or the Measurement Period ending with such calendar month, as applicable, as well as (b) any liquidated damages to be assessed, as set forth in the form of Monthly Report set forth in **Section 1** (Monthly Report) of said **Attachment S** (Monthly Reporting and Dispute Resolution by Independent Evaluator). The rights and obligations of the Parties with respect to each Monthly Report and any disagreements arising out of any Monthly Report are set forth in **Section 1** (Monthly Report) and **Section 2** (Monthly Report Disagreements) of **Attachment S** (Monthly Reporting and Dispute Resolution by Independent Evaluator) to this Agreement.

#### **5.4. Payment Procedures.**

By the twentieth (20<sup>th</sup>) Business Day of each calendar month following the month during which the invoice was submitted (i.e., by the twentieth (20<sup>th</sup>) Business Day of the second calendar month following the calendar month covered by the invoice in question), but, except as otherwise provided in the following sentence, no later than the last Business Day of that month if there are less than twenty (20) Business Days in that month, Company shall, subject to its right to set-off liquidated damages as provided in **Section 4.6** (Payment of Liquidated Damages for Failure to Achieve Performance Levels; Limitation on Liquidated Damages), make payment on such invoice, or provide to Seller an itemized statement of its objections to all or any portion of such invoice and pay any undisputed amount. Notwithstanding the foregoing, the Day by which Company shall make payment to Seller hereunder shall be increased by one (1) Day for each Day that Seller is delinquent in providing to Company either: (a) the Monthly Report for the calendar month in question pursuant to **Section 1** (Monthly Report) of **Attachment S** (Monthly Reporting and Dispute Resolution by Independent Evaluator); or (b) the information required under **Section 5.3** (Seller's Preparation of the Monthly Invoice and Monthly Report) of this Agreement.

#### **5.5. Late Payments.**

Notwithstanding all or any portion of such invoice in dispute, and subject to the provisions of **Section 4.6** (Payment of Liquidated Damages for Failure to Achieve Performance Levels), interest shall accrue on any invoiced amount that remains unpaid following the twentieth (20<sup>th</sup>) Business Day of each calendar month (or the last Business Day of that month if there are less than twenty (20) Business Days in that month), or following the due date for such payment if extended pursuant to **Section 5.4** (Payment Procedures), at the average daily Prime Rate for the period commencing on the Day following the Day such payment is due until the invoiced amounts (or amounts due to Seller if determined to be less than the invoiced amounts) are paid in full. Partial payments shall be applied first to outstanding interest and then to outstanding invoice amounts.

#### **5.6. Adjustments to Invoices After Payment.**

In the event adjustments are required to correct inaccuracies in an invoice after payment, the Party requesting adjustment shall recompute and include in the Party's request the principal amounts due during the period of the inaccuracy together with the amount of interest from the date that such invoice was payable until the date that such recomputed amount is paid at the average daily Prime Rate for the period. The difference between the amount paid and that recomputed for the invoice, along with the allowable amount of interest, shall either be (a) paid to Seller or set-off by Company, as appropriate, in the next invoice payment to Seller; or (b) objected to by the Party responsible for such payment within thirty (30) Days following its receipt of such request. If the Party responsible for such payment objects to the request, then the Parties shall work together in good faith to resolve the objection. If the Parties are unable to resolve the objection, the matter shall be resolved pursuant to **Article 26** (Dispute Resolution). All claims for adjustments shall be waived for any amounts that were paid or should have been payable more than thirty-six (36) months preceding the

date of receipt of any such request.

**5.7. Company's Billing Records.**

Seller, after giving reasonable advance written notice to Company, shall have the right to review all billing, metering and related records necessary to verify the accuracy of payments relating to the Facility during Company's normal working hours on Business Days. Company shall maintain such records for a period of not less than thirty-six (36) months.

**5.8. Set Off.**

Company shall have the right to set off any payment due and owing by Seller, including, but not limited to, any payment under this Agreement and any payment due under any award made under **Article 26** (Dispute Resolution), against Company's payments of subsequent monthly invoices as necessary.

## **ARTICLE 6**

### **EVENTS OF DEFAULT; REMEDIES; TERMINATION**

#### **6.1. Events of Default by Seller.**

The occurrence of any of the following shall constitute an Event of Default by Seller:

- (a)** Subsequent to the Commercial Operations Date, Seller procures, provides or substitutes Energy Storage Services from any source other than the Facility;
- (b)** Seller sells, assigns, or otherwise transfers, or commits to sell, assign, or otherwise transfer, any portion or component of the Energy Storage Services (e.g., Discharge Energy), or the availability thereof, to any party other than Company;
- (c)** Subsequent to the Commercial Operations Date, Seller fails to achieve the Performance Level Rated Energy Capacity in two (2) consecutive Measurement Periods;
- (d)** Subsequent to the Commercial Operations Date, Seller fails to (i) achieve a Measured Availability of not less than 95% for any calendar month, or (ii) limit the aggregate hours of unavailability caused by Unplanned Outages during the Initial Term to no more than three hundred thirty-six (336) hours;
- (e)** Subsequent to the Commercial Operations Date, if the RTE Ratio is more than three (3) percentage points below the Performance Level RTE in two (2) consecutive Measurement Periods;
- (f)** If at any time during the Term, Seller fails to satisfy the requirements specified in **Article 14** (Credit Assurance and Security) of this Agreement;
- (g)** It at any time during the Term, Seller fails to comply with the requirements of **Section 15.1** (Sale of the Facility) and **Attachment P** (Sale of Facility by Seller);
- (h)** Seller fails to comply with the Charging Energy obligations under **Article 8** (Charging Energy Obligations);
- (i)** Subsequent to the Commercial Operations Date, the Facility is unavailable to provide the Energy Storage Services to Company in response to Company Dispatch/Charge pursuant to the terms and conditions of this Agreement for a period of one hundred twenty (120) or more consecutive Days; or
- (j)** Subsequent to the Commercial Operations Date, Seller fails to operate, maintain, or repair the Facility in accordance with Good Engineering and Operating Practices if such failure is not cured within thirty (30) Days after written notice of such failure from Company unless such failure cannot be cured within said thirty (30) Day period and Seller is making commercially reasonable efforts to cure such failure,



in which case Seller shall have a cure period of sixty (60) Days after Company's written notice of such failure.

## **6.2. Events of Default by a Party.**

The occurrence of any of the following during the Term of the Agreement shall constitute an Event of Default by the Party responsible for the failure, action or breach in question:

(a) The failure to make, when due, any payment required to be made to the other Party pursuant to this Agreement, if such failure is not cured within ten (10) Business Days after written notice of such failure is received by the non-performing Party;

(b) Any representation or warranty made by such Party herein is false or misleading in any material respect when made or when deemed made or repeated if the representation or warranty is continuing in nature;

(c) Such Party becomes insolvent, or makes an assignment for the benefit of creditors (other than an assignment to a Facility Lender pursuant to the Financing Documents) or fails generally to pay its debts as they become due; or such Party shall have an order for relief in an involuntary case under the bankruptcy laws as now or hereafter constituted entered against it, or shall commence a voluntary case under the bankruptcy laws as now or hereafter constituted, or shall file any petition or answer seeking for itself any arrangement, composition, adjustment, liquidation, dissolution or similar relief to which it may be entitled under any present or future statute, law or regulation, or shall file any answer admitting the material allegations of any petition filed against it in such proceeding; or such Party seeks or consents to or acquiesces in the appointment of or taking possession by, any custodian, trustee, receiver or liquidator of it or of all or a substantial part of its properties or assets; or such Party takes action looking to its dissolution or liquidation; or within ninety (90) Days after commencement of any proceedings against such Party seeking any arrangement, composition, adjustment, liquidation, dissolution or similar relief under any present or future statute, law or regulation, such proceedings shall not have been dismissed; or within ninety (90) Days after the appointment of, or taking possession by, any custodian, trustee, receiver or liquidator of any or of all or a substantial part of the properties or assets of such Party, without the consent or acquiescence of such Party, any such appointment or possession shall not have been vacated or terminated;

(d) Such Party engages in or is the subject of a transaction requiring the prior written consent of the other Party under **Section 15.2** (Assignment by Seller) or **Section 15.6** (Assignment by Company), as applicable, without having obtained such consent;

(e) Such Party fails to comply with either (i) a decision under **Article 26** (Dispute Resolution); or (ii) an Independent Evaluator's decision under **Article 22** (Revisions to Performance Standards), in either case within thirty (30) Days after such decision becomes binding on the Parties in accordance with **Article 26** (Dispute Resolution) or within thirty (30) Days of the issuance of such decision under **Article 22** (Revisions to Performance Standards), as applicable, or, if such decision cannot be



complied with within thirty (30) Days, such Party fails to have commenced commercially reasonable efforts designed to achieve compliance within such thirty (30) Days and diligently continues such commercially reasonable efforts until compliance is attained; or

(f) A Party, by act or omission, materially breaches or defaults on any material covenant, condition or other provision of this Agreement, other than the provisions specified in **Section 6.1** (Events of Default by Seller) and **Section 6.2(a)** through **Section 6.2(e)**, if such breach or default is not cured within thirty (30) Days after written notice of such breach or default from the other Party; provided, however, that if the breach or default in question is one that could not be cured within said thirty (30) Day period by an experienced independent power producer or electric utility, as applicable, willing and able to exert commercially reasonable efforts to timely achieve such cure, then, for so long as the non-performing Party is making the same effort to cure such breach or default as would be expected of an experienced independent power producer or electric utility, as applicable, willing and able to exert commercially reasonable efforts to timely achieve such cure, the non-performing Party shall have a cure period equal to the shorter of (i) the duration of the period within which a cure could reasonably be expected to be achieved by an experienced independent power producer or electric utility, as applicable, willing and able to exert commercially reasonable efforts to achieve such cure; or (ii) a period of one hundred twenty (120) Days beginning on the date of written notice of such breach or default; provided, further, that if the material breach in question involves Seller's failure to meet the operational and performance standards set forth in **Attachment B** (Facility Owned by Seller), the provisions of **Section 1(j)** (Demonstration of Facility) of **Attachment B** (Facility Owned by Seller) shall apply in lieu of the extended cure period provided under the preceding proviso.

### **6.3. Cure/Grace Periods.**

Before becoming an Event of Default, the occurrences set forth in **Section 6.1** (Events of Default by Seller) and **Section 6.2** (Events of Default by a Party) are subject to the following cure/grace periods:

(a) If the occurrence is not the result of Force Majeure, the non-performing Party shall be entitled to a cure period to the limited extent expressly set forth in the applicable provision of **Section 6.1** (Events of Default by Seller) or **Section 6.2** (Events of Default by a Party); or

(b) If the occurrence is the result of Force Majeure, and if and so long as the conditions set forth in **Section 17.4** (Satisfaction of Certain Conditions) are satisfied, the non-performing Party shall be entitled to a grace period as provided in **Section 17.5** (Termination for Force Majeure), which shall apply in lieu of any cure periods provided in **Section 6.1** (Events of Default by Seller) and **Section 6.2** (Events of Default by a Party).

### **6.4. Rights of the Non-Defaulting Party; Forward Contract.**

If an Event of Default shall have occurred and be continuing, the other Party (the "**Non-Defaulting Party**") shall have the right to (a) terminate this Agreement by

sending notice to the Defaulting Party as provided in this **Section 6.4** (Rights of the Non-Defaulting Party; Forward Contract); (b) withhold any payments due to the Defaulting Party under this Agreement; (c) suspend performance; and (d) exercise any other right or remedy available at law or in equity to the extent permitted under this Agreement, including, without limitation, **Section 6.6** (Equitable Remedies). A notice terminating this Agreement pursuant to this **Section 6.4** (Rights of the Non-Defaulting Party; Forward Contract) shall designate the Day such termination is to be effective (the “**Termination Date**”) which shall be no later than thirty (30) Days after such notice is deemed to be received by the Defaulting Party and not earlier than the first to occur of the Day such notice is deemed to be received by the Defaulting Party or the Day following the expiration of any period afforded the Defaulting Party under **Section 6.1** (Events of Default by Seller) and **Section 6.2** (Events of Default by a Party) to cure the default in question. Without limiting the generality of the foregoing provisions of this **Section 6.4** (Rights of the Non-Defaulting Party; Forward Contract), the Parties agree that, under 11 U.S.C. § 362(b)(6), this Agreement constitutes a “forward contract,” and Company is a “forward contract merchant” such that, upon the occurrence of an Event of Default by Seller under **Section 6.1** (Events of Default by Seller) or **Section 6.2** (Events of Default by a Party), this Agreement may be terminated by Company as provided in this Agreement notwithstanding any bankruptcy petition affecting Seller.

#### **6.5. Calculation of Termination Damages.**

In the event of this Agreement is terminated by Company due to one or more Events of Default by Seller of this Agreement, Company shall have the right to collect liquidated damages in an amount equal to two (2) times the annual Lump Sum Payment (the “**Termination Damages**”).

#### **6.6. Equitable Remedies.**

Seller acknowledges that Company is a public utility and is relying upon Seller’s performance of its obligations under this Agreement, and that Company and/or its customers may suffer irreparable injury as a result of the failure of Seller to perform any of such obligations, whether or not such failure constitutes an Event of Default or otherwise gives rise to one or more of the remedies set forth in **Section 6.5** (Calculation of Termination Damages). Accordingly, the remedies set forth in **Section 6.5** (Calculation of Termination Damages) shall not limit or otherwise affect Company’s right to seek specific performance injunctions or other available equitable remedies for Seller’s failure to perform any of its obligations under this Agreement, irrespective of whether such failure constitutes an Event of Default.

**ARTICLE 7**  
**COMPANY-OWNED INTERCONNECTION FACILITIES**

The terms and conditions related to the Company-Owned Interconnection Facilities are set forth in **Attachment G** (Company-Owned Interconnection Facilities) of this Agreement.

## **ARTICLE 8**

### **CHARGING ENERGY OBLIGATIONS**

Except as otherwise set forth in this **Article 8** (Charging Energy Obligations) or as expressly set forth in this Agreement, following the Commercial Operations Date, Company shall be responsible for and bear the cost of delivering all of the Charging Energy for the Facility to the Point of Interconnection. So long as the State of Charge is less than 100%, Seller shall take all actions necessary to accept the Charging Energy, as delivered by Company by manual dispatch or automatic signals, at and from the Point of Interconnection as part of making available to Company the Facility's Energy Storage Services in accordance with the terms of this Agreement and Company tariffs, including, without limitation, maintenance, repair or replacement of equipment in Seller's possession or control used to deliver the Charging Energy to the Facility. Seller shall only use the Charging Energy for Company's benefit in accordance with the terms of this Agreement.

## **ARTICLE 9**

### **METERING; MONITORING AND COMMUNICATIONS**

#### **9.1. Revenue Metering Package; Station Use Metering Equipment.**

(a) Company shall purchase, own, install and maintain the Revenue Metering Package dedicated exclusively to the Facility and by which all measurable aspects of the Energy Storage Services must be measured to be eligible for payment under this Agreement. The metering point shall be located as close as possible to the Point of Interconnection as allowed by Company, and Seller shall make available a mutually agreeable location for the Revenue Metering Package, to measure the Discharge Energy, the Charging Energy, and Station Use.

(b) Seller shall install, own and maintain the infrastructure and other related equipment associated with the Revenue Metering Package and the Station Use Metering Equipment, including but not limited to all enclosures (meter cabinets, meter pedestals, meter sockets, pull boxes, and junction boxes, along with their grounding/bonding connections), CT/PT mounting structures, conduits and ductlines, enclosure support structures, ground buses, pads, test switches, terminal blocks, isolation relays, telephone surge suppressors, and analog phone lines (one per meter), subject to Company's review and approval, as further described in **Section 1(e)** (Other Equipment) of **Attachment B** (Facility Owned by Seller). Seller shall install this infrastructure such that it meets the requirements set forth in Chapter Six (IPP Metering) of the latest edition of the Company's Electric Service Installation Manual (ESIM). Company shall test such meter equipment prior to installation and every fifth (5<sup>th</sup>) year thereafter. Seller shall reimburse Company for all reasonably incurred costs for the procurement, installation, maintenance (including maintenance replacements) and testing work associated with the Revenue Metering Package and the Station Use Metering Equipment.

#### **9.2. Meter Testing.**

Company shall provide at least twenty-four (24) hours' notice to Seller prior to any test it may perform on the revenue meters or metering equipment. Seller shall have the right to have a representative present during each such test. Seller may request, and Company shall perform, if requested, tests in addition to the every fifth (5<sup>th</sup>) year test and Seller shall pay the cost of such tests. Company may, in its sole discretion, perform tests in addition to the fifth (5<sup>th</sup>) year test and Company shall pay the cost of such tests. If any of the metering equipment is found to be inaccurate at any time, as determined by testing in accordance with this **Section 9.2** (Meter Testing), Company shall promptly cause such equipment to be made accurate, and the period of inaccuracy, as well as an estimate for correct meter readings, shall be determined in accordance with **Section 9.3** (Corrections).

### **9.3. Corrections.**

If any test of the metering equipment conducted by Company indicates that the meter readings are in error by one percent (1%) or more, the meter readings shall be corrected as follows: (a) determine the error by testing the meter at approximately ten percent (10%) of the rated current (test amperes) specified for such meter; (b) determine the error by testing the meter at approximately one hundred percent (100%) of the rated current (test amperes) specified for the meter; (c) the average meter error shall then be computed as the sum of (i) one-fifth ( $\frac{1}{5}$ ) of the error determined in the foregoing clause (a) and (ii) four-fifths ( $\frac{4}{5}$ ) of the error determined in the foregoing clause (b). The average meter error shall be used to adjust the invoices in accordance with **Section 5.6** (Adjustments to Invoices After Payment) for the Energy Storage Services made available to Company for the previous six (6) months from the Facility, unless records of Company conclusively establish that such error existed for a greater or lesser period, in which case the correction shall cover such actual period of error.

### **9.4. Monitoring and Communications Equipment.**

Seller shall install and maintain appropriate equipment, including high-resolution data recording equipment, for the purposes of (a) measuring the data required for Company to monitor Seller's compliance with the operational and performance standards set forth in **Section 3** (Performance Standards) of **Attachment B** (Facility Owned by Seller) and, if the monitoring equipment is part of the Company-Owned Interconnection Facilities, as set forth in **Attachment G** (Company-Owned Interconnection Facilities), such data to include, without limitation, current charge or discharge power, available charge and discharge power capacity, current energy capacity, State of Charge, and current dispatch points; and (b) recording and transferring such data to Company in real time (the "**Monitoring and Communications Equipment**"). Seller shall maintain at the Site sufficient replacement parts to avoid or otherwise minimize any shutdown pursuant to **Section 9.6** (Shutdown for Lack of Reliable Real Time Data) while any of the Monitoring and Communication Equipment is being repaired, replaced or re-calibrated.

### **9.5. Calibrations, Maintenance and Repairs.**

(a) **Documentation Requirement.** Seller shall provide to Company (i) the manufacturer's recommended schedule for the calibration and maintenance of each component of the Monitoring and Communication Equipment; and (ii) subject to the limitation set forth in **Section 1(a)(ii)** (As-Builts) of **Attachment B** (Facility Owned by Seller) of this Agreement, documentation of the performance of all such calibration and maintenance per manufacturer specifications. Although Company is to receive from Seller the aforesaid recommended schedules for calibration and maintenance, as well documentation of the performance of all such calibration and maintenance, Company shall have no responsibility to monitor Seller's compliance with such calibration and maintenance schedules. Accordingly, any failure by Company to bring Seller's attention any apparent failure by Seller to perform such recommended calibration and maintenance shall neither relieve Seller of its obligations under this Agreement to perform such calibration and maintenance nor constitute a waiver of

Company's rights under this Agreement with respect to such failure in performance by Seller.

**(b) Corrective Measures; Repairs.** In the event of a pattern of material inconsistencies in the data stream provided by the Monitoring and Communication Equipment, Seller shall perform, at Seller's expense, such corrective measures as Company may reasonably require, such as the recalibration of all field measurement device components of the Monitoring and Communication Equipment. In the event of any failure in the Monitoring and Communication Equipment, Seller shall repair or replace such equipment within five (5) Days of such failure, or within such longer period as may be reasonably agreed to by the Parties.

## **9.6. Shutdown for Lack of Reliable Real Time Data.**

Company shall have the right to direct Seller to shutdown the Facility due to the unavailability of reliable real time data as required under **Section 9.4** (Monitoring and Communications Equipment). In addition, in the event of the performance of corrective measures (including recalibration) and/or repairs to any Monitoring and Communications Equipment pursuant to **Section 9.5(b)** (Corrective Measures; Repairs), Company shall have the right to direct Seller to shutdown the Facility and the Facility shall remain shutdown until such corrective action and/or repairs are completed. In the event the cause for any shutdown in this **Section 9.6** (Shutdown For Lack of Reliable Real Time Data) falls within the definition of Seller-Attributable Unavailability, such period of time shall be allocated as such for purposes of calculating the Measured Availability under **Section 4.4(a)** (Measured Availability and Liquidated Damages) of this Agreement until such time as the successful completion of such corrective measures and/or repairs has been communicated by Seller to Company. If, after such communication, Company attempts to dispatch the Facility and determines that such corrective measures and/or repairs were not successfully completed, all time from the notice of successful completion to actual successful completion shall be revised as continuance of the deration or outage. Notwithstanding the foregoing, if Seller requests in writing for confirmation that the Facility's data is available to Company, then Company shall use reasonable efforts to respond to such request within three (3) Business Days in writing (with Email being acceptable) confirming that either (1) the Facility's data is available to Company (at which point no additional time after such request shall count as Seller-Attributable Unavailability), or (2) the Facility's data is not available so that Seller can take further appropriate corrective actions.

## **ARTICLE 10**

### **GOVERNMENTAL APPROVALS AND LAND RIGHTS**

**[DRAFTING NOTE: Appropriate/additional revisions shall be made to this Agreement, including this Article 10, to reference the applicable terms of Attachment X to account for use of Company-controlled Site.]**

#### **10.1. Governmental Approvals for Facility.**

Seller shall obtain, at its expense, any and all Governmental Approvals required for the construction, ownership, operation and maintenance of the Facility and the interconnection of the Facility to the Company System. Under no circumstances shall Seller commence any construction, operation or maintenance of the Facility or interconnection of the Facility to the Company System, without Seller first obtaining the required, applicable Governmental Approvals.

#### **10.2. Land Rights for Facility.**

(a) Seller's construction, ownership, operation and maintenance of the Facility on the Site and the interconnection of the Facility to the Company System shall be subject to the terms and conditions of **Attachment X** (Company-Controlled Site). If requested by Company, Seller shall execute such additional Land Rights documentation, in a form acceptable to Company, related to Seller's utilization of the Site for the construction, ownership, operation and maintenance of the Facility on the Site and/or the interconnection of the Facility to the Company System.

(b) Under no circumstances shall Seller commence any construction, operation or maintenance of the Facility or interconnection of the Facility to the Company System, or require or permit Company to commence any such construction, without Seller first obtaining the required, applicable Land Rights. Seller shall bear complete responsibility for all delays in construction, operation and maintenance of the Facility or the interconnection of the Facility to the Company System resulting from Seller's failure to timely obtain necessary Land Rights.

#### **10.3. Compliance With Laws.**

Seller shall at all times comply with all applicable Laws and shall be responsible for all costs and expenses associated therewith.



## **ARTICLE 11**

### **CONSTRUCTION PERIOD AND MILESTONES**

#### **11.1. Time is of the Essence.**

Time is of the essence of this Agreement, and Seller's ability to timely achieve the Construction Milestones is critically important.

#### **11.2. Monthly Progress Report.**

Commencing upon the Execution Date of this Agreement, Seller shall submit to Company, on the tenth (10<sup>th</sup>) Business Day of each calendar month until the Commercial Operations Date, a progress report for the prior month in a form set forth on **Attachment R** (Form of Monthly Progress Report) ("**Monthly Progress Report**"). These progress reports shall notify Company of the current status of each Construction Milestone. Seller shall include in any Monthly Progress Report a list of all letters, notices, applications, approvals, authorizations and filings referring or relating to Governmental Approvals, and shall provide any such documents as may be reasonably requested by Company. In addition, Seller shall advise Company, as soon as reasonably practicable, of any problems or issues of which Seller is aware which could materially impact its ability to timely achieve any Construction Milestone. Seller shall provide Company with any requested documentation to support the achievement of an applicable Construction Milestone within ten (10) Business Days of receipt of such request from Company. Upon the occurrence of a Force Majeure event, Seller shall also comply with the requirements of **Section 17.4** (Satisfaction of Certain Conditions) to the extent such requirements provide for communications to Company beyond those required under this **Section 11.2** (Monthly Progress Report).

#### **11.3. Remedial Action Plan.**

In the event Seller does not timely achieve a Reporting Milestone, Seller shall submit to Company, within ten (10) Business Days of any such missed Reporting Milestone date, a remedial action plan which shall provide a detailed description of Seller's course of action and plan to achieve (a) the missed Reporting Milestone within thirty (30) Days of the missed Reporting Milestone date; and (b) all subsequent Construction Milestones; provided, that delivery of any remedial action plan shall not relieve Seller of its obligation to timely achieve such Construction Milestones.

#### **11.4. Milestone Dates.**

Seller shall achieve each Guaranteed Project Milestone Date or Reporting Milestone Date, subject (to the extent applicable) to the following extensions:

(a) if the PUC Approval Order Date occurs more than one hundred eighty (180) Days after the Execution Date, Seller and Company shall be entitled to an extension of the Guaranteed Project Milestone Dates, Reporting Milestone Dates, Seller's Conditions Precedent Dates and Company Milestone Dates equal to the number of Days that elapse between the end of the aforesaid 180-Day period and the

PUC Approval Order Date; provided, that in no event will the Guaranteed Commercial Operations Date be extended beyond **[May 21, 2025]**;

**(b)** if the failure to achieve a Construction Milestone by the applicable Guaranteed Project Milestone Date or Reporting Milestone Date is the result of Force Majeure (which, for purposes of this **Section 11.4(b)** excludes any delay in obtaining the PUC Approval Order because that contingency is addressed in **Section 11.4(a)** above), and if and so long as the conditions set forth in **Section 17.4** (Satisfaction of Certain Conditions) are satisfied, such Guaranteed Project Milestone Date or Reporting Milestone Date shall be extended by a period equal to the lesser of one hundred twenty (120) Days or the duration of the delay caused by the Force Majeure; or

**(c)** if the failure to achieve a Guaranteed Project Milestone by the applicable Guaranteed Project Milestone Date is the result of any failure by Company in the timely performance of its obligations under this Agreement, including achievement of its Company Milestones by the Company Milestone Dates as set forth on **Attachment K-1** (Seller's Conditions Precedent and Company Milestones), as such dates may be extended in accordance with **Section 11.4** (Milestone Dates) and **Section 11.5** (Company Milestones), Seller shall, provided Seller has satisfied Seller's Conditions Precedent set forth in **Attachment K-1** (Seller's Conditions Precedent and Company Milestones) by the respective Seller's Conditions Precedent Date set forth in said **Attachment K-1**, be entitled to an extension of such Guaranteed Project Milestone Date equal to the duration of the period of delay directly caused by such failure in Company's timely performance. Such extension on the terms described above shall be Seller's sole remedy for any such failure by Company. For purposes of this **Section 11.4(c)**, Company's performance will be deemed to be "timely" if it is accomplished within the time period specified in this Agreement with respect to such performance or, if no time period is specified, within a reasonable period of time. If the performance in question is Company's review of plans, the determination of what is a "reasonable period of time" will take into account Company's past practices in reviewing and commenting on plans for similar facilities.

## **11.5. Company Milestones.**

Company's obligation to achieve the Company Milestones is contingent upon Seller completing the Seller's Conditions Precedent set forth in **Attachment K-1** (Company Milestones and Seller's Conditions Precedent). Company shall achieve each of the Company Milestones by the date set forth for such Company Milestones in **Attachment K-1** (Seller's Conditions Precedent and Company Milestones) of this Agreement (each such date, a "**Company Milestone Date**"), as such date may be extended in accordance with **Section 11.4** (Milestone Dates) and this **Section 11.5** (Company Milestones); provided, however in the event Seller does not complete a Seller's Condition Precedent on or before the applicable date set forth in **Attachment K-1** (Seller's Conditions Precedent and Company Milestones) (each such date, a "**Seller's Conditions Precedent Date**"), subject to the extensions set forth in **Section 11.4** (Milestone Dates), Company shall be entitled to an extension as follows: (i) for the commencement of Acceptance Testing, the new Company Milestone Date shall be as set forth in clause "(vii)" of **Section 3(a)** of **Attachment G** (Company-Owned Interconnection Facilities); and (ii) for any other Company Milestone Date, the extension shall be for the period of time reasonably necessary to meet any such

Company Milestone Date adversely affected by Seller's failure, which extension shall be no shorter than a day-for-day extension.

## **11.6. Damages and Termination.**

### **(a) Daily Delay Damages.**

**(i)** If a Guaranteed Project Milestone (other than Commercial Operations) has not been achieved by the applicable Guaranteed Project Milestone Date, as extended as provided in **Section 11.4** (Milestone Dates), Company shall collect and Seller shall pay liquidated damages in the amount of \$\_\_\_\_\_ (“**Daily Delay Damages**”) for each Day following the applicable Guaranteed Project Milestone Date, as extended in accordance with **Section 11.4** (Milestone Dates); provided, however, that the number of Days for which Company shall collect and Seller shall pay Daily Delay Damages for a failure to achieve a Guaranteed Project Milestone by the Guaranteed Project Milestone Date shall not exceed thirty (30) Days for each such missed Guaranteed Project Milestone Date (the “**Construction Delay LD Period**”).  
**[Note: Daily Delay Damages = Contract Capacity x \$50/kW ÷ 180 Days]**

**(ii)** If the Commercial Operations Date has not been achieved by the Guaranteed Commercial Operations Date, as extended as provided in **Section 11.4** (Milestone Dates), in addition to any Daily Delay Damages collected pursuant to **Section 11.6(a)(i)**, Company shall collect and Seller shall pay Daily Delay Damages for each Day following the Guaranteed Commercial Operations Date, as such date may be extended in accordance with **Section 11.4** (Milestone Dates); provided that the number of Days for which Company shall collect and Seller shall pay Daily Delay Damages for failing to timely achieve the Commercial Operations Date shall not exceed sixty (60) Days (the “**COD Delay LD Period**”).

**(b) Termination and Termination Damages for Failure to Achieve Guaranteed Project Milestone Date.** If, upon the expiration of the Construction Delay LD Period or the COD Delay LD Period, as applicable, Seller has not achieved the applicable Guaranteed Project Milestone, Company shall have the right, notwithstanding any other provision of this Agreement to the contrary, to terminate this Agreement with immediate effect by issuing a written termination notice to Seller designating the Day such termination is to be effective; provided, that Company shall issue such notice no later than thirty (30) Days following the expiration of the Construction Delay LD Period or the COD Delay LD Period, as applicable. The effective date of such termination shall be not later than the date that is thirty (30) Days after such notice is deemed to be received by Seller, and not earlier than the later to occur of the Day such notice is deemed to be received by Seller or the Day following the expiration of the Construction Delay LD Period or the COD Delay LD Period, as applicable. If the Agreement is terminated by Company pursuant to this **Section 11.5** (Damages and Termination), Company shall have the right to collect Termination Damages, which shall be calculated in accordance with **Section 6.5** (Calculation of Termination Damages) of this Agreement.

## **11.7. Payment of Daily Delay Damages.**

Company shall draw upon the Development Period Security on a monthly basis for payment of the total Daily Delay Damages incurred by Seller during the preceding calendar month. If the Development Period Security is at any time insufficient to pay the amount of the draw to which Company is then entitled, Seller shall pay any such deficiency to Company promptly upon demand.

### **11.8. Liquidated Damages Appropriate.**

The Parties acknowledge and agree that (a) the damages that Company would incur due to either (i) a delay in achieving Commercial Operations by the Guaranteed Commercial Operations Date (subject to the extensions provided in **Section 11.4** (Milestone Dates)); or (ii) the termination of this Agreement, would be difficult or impossible to calculate with certainty; (b) the Daily Delay Damages set forth in **Section 11.6** (Damages and Termination) and the Termination Damages calculated in accordance with **Section 6.5** (Calculation of Termination Damages), respectively, are an appropriate approximation of such damages; (c) the Daily Delay Damages are the sole and exclusive remedies for Seller's failure to achieve Commercial Operations by the Guaranteed Commercial Operations Date; and (d) the Termination Damages are the sole and exclusive remedy for Company's losses arising out of the termination of this Agreement; provided, that (i) payment of Termination Damages does not relieve Seller of liability for costs and balances incurred prior to the effective date of such termination; and (ii) the Termination Damages are not intended to limit Company's rights or remedies, or Seller's liabilities or duties, with respect to losses arising independent of the termination of this Agreement, including, without limitation, Company's right to recover under **Section 20.1** (Indemnification of Company).

## **ARTICLE 12 DISPATCHING AND CHARGING THE FACILITY; SCHEDULING**

### **12.1. Dispatching and Charging the Facility.**

(a) **Company's Exclusive Rights.** Company shall have the exclusive right, through supervisory equipment or otherwise, to direct and control the provision of all aspects of the Energy Storage Services, at any time, as it deems appropriate in its reasonable discretion, subject only to and consistent with Good Engineering and Operating Practices, the operational and performance standards requirements set forth in **Section 3** (Performance Standards) of **Attachment B** (Facility Owned by Seller), and Seller's maintenance schedule determined in accordance with **Section 12.2** (Seller's Maintenance Schedule) ("**Company Dispatch/Charge**"). Seller shall make the full capability of the Facility available for Company Dispatch/Charge. When not in a Microgrid configuration, the Facility will be charged pursuant to Company Dispatch/Charge and, once charged, shall remain ready to support Microgrid operation for planned and unplanned outages of the grid connection. Company Dispatch/Charge will be under the direction of the Company remote computerized control provided in **Section 1(g)** (Active Power Control Interface) of **Attachment B** (Seller's Facility), in each case at Company's reasonable discretion, and in accordance with the Performance Standards..

(b) **Failure to Comply; Seller-Attributable Unavailability.** Company may require deration or outage in response to the Facility's failure to comply with Company Dispatch/Charge or to any conditions of Seller-Attributable Unavailability. A deration or outage required by Company pursuant to the preceding sentence shall be considered Seller-Attributable Unavailability and shall count against Seller for the purpose of calculating the Measured Availability until the conditions that led to the deration or outage are resolved by Seller and Seller notifies Company of same. If, after such notification, Company attempts to dispatch the Facility and determines that such conditions that led to the deration or outage are not resolved, all time from the notice of resolution to actual resolution shall be revised as continuance of the deration or outage. If Seller requests confirmation from Company that Seller's actions to resolve such conditions that led to the deration or outage were successfully completed, then Company shall use reasonable efforts to respond to such request within three (3) Business Days in writing (with Email being acceptable) to allow Seller the opportunity to take further appropriate corrective actions if needed.

### **12.2. Seller's Maintenance Schedule.**

(a) **Monthly Schedule.** By the first of each calendar month subsequent to the Commercial Operations Date, Seller shall provide to Company, in the form requested by Company, a projection of maintenance outages and estimated reductions in capacity for the next calendar month. Seller shall provide Company with prompt written notice of any deviation from its monthly maintenance schedule but in any case Seller shall provide such written notice not less than one (1) week prior to commencing any such rescheduled maintenance event. During any scheduled or rescheduled

maintenance event, Seller shall provide updates to Company's operating personnel in the event there are any delays or changes to the proposed schedule, and shall promptly respond to any requests from Company for updates regarding the status of such maintenance event.

**(b) Annual Schedule.** By each June 30 subsequent to the Commercial Operations Date, Seller shall submit to Company, in the form requested by Company, a schedule of maintenance outages which will reduce the capacity of the Facility by **0.5 MW** or more for the next one-year period, beginning with January of the following year. Such annual schedule shall state the proposed dates and durations of scheduled maintenance, the scope of work for the maintenance and the estimated reductions in capacity for each projected maintenance event. Company shall review the maintenance schedule for the one-year period and inform Seller in writing no later than December 1 of the same year of Company's concurrence or requested revisions, which Seller shall agree to unless, in Seller's judgment, such proposed revisions will void or violate any warranties of equipment that is part of, or used in connection with, the Facility or violate any long-term service agreement with respect to such equipment; provided, that, in each such case, Seller shall promptly notify Company thereof, and Seller and Company shall endeavor to reach a mutually satisfactory resolution of the matter in question. Seller shall provide Company with written notice of an upcoming maintenance outage not less than one (1) week prior to commencing any such maintenance event.

**(c) Scheduling of Maintenance Outages.** Seller shall coordinate the scheduling of all planned maintenance outages with the Company to ensure all such outages occur at times when Company's System is at low risk, as determined by Company, for requiring any of the Energy Storage Services from the Facility. Seller shall work with Company to limit maintenance outages, when possible, to partial outages of the Facility instead of a total Facility outage.

### **12.3. Seller's Notification Obligations.**

When Seller learns that any of its equipment will be removed from or returned to service, and any such removal or return may affect the ability of the Facility to make the Energy Storage Services available to Company, Seller shall notify Company as soon as practicable and provide Company with any reasonably requested information, and any unit shut-down shall be coordinated with Company in advance to the extent practicable.



## **ARTICLE 13**

### **FACILITY OPERATIONS, MAINTENANCE AND REPAIR**

#### **13.1. Operations Logs.**

Seller shall maintain a daily operations log for the Facility which shall record all pertinent data that will indicate whether the Facility is being operated in accordance with Good Engineering and Operating Practices. These data logs shall include, but not be limited to, information on charging and discharging, electric energy consumption and efficiency, the electrical characteristics of each Storage Unit (including settings or adjustments of such Storage Unit(s) control equipment/power conversion system and protective devices), availability (including availability to charge and discharge and its ability to store energy), maintenance and inspections performed and/or deferred (including applicable correspondence between Seller and its insurer(s) for the Facility equipment pertaining to Seller's maintenance practices and Seller's procedures and scheduling (including deferral) of maintenance at the Facility), testing, Outages, changes in operating status, unusual conditions experienced or observed, and any other significant events related to the operation of the Facility. Company shall have the right, upon reasonable notice and during regular Business Day hours to review and copy such data logs maintained pursuant to this **Section 13.1** (Operations Logs); provided, that if such logs reveal any inconsistency with Company's records, Company may request and review Seller's supporting records, correspondence, memoranda and other documents or electronically recorded data associated with such logs related to the operation and maintenance of the Facility in order to resolve such inconsistency.

#### **13.2. Maintenance and Repair.**

**(a) Seller's Summary of Maintenance and Inspection Performed.** Prior to February 1 of each calendar year, Seller shall submit to Company for inspection at the Site, a summary in a format similar to the example provided in **Attachment W** (Summary of Maintenance and Inspection Performed in Prior Calendar Year) of (i) all maintenance and inspection work performed in the prior calendar year; (ii) all conditions experienced or observed during such calendar year that may have a material adverse effect on or may materially impair the short-term or long-term operation of the Facility at the operational levels contemplated by this Agreement; and (iii) Seller's proposals for correcting or preventing recurrences of identified equipment problems and for performing such other maintenance and inspection work as is required by Good Engineering and Operating Practices. The summary shall present the requested data in a meaningful and informative manner consistent with the cooperative exchange of information between the Parties. If available and practicable, such summary shall be provided in electronic format with sufficient software so that Company can group activities for specific process areas of the Facility and be able to view the maintenance history of a specific equipment item.

**(b) Company's Written Recommendations.** Within sixty (60) Days of receiving such summary, and after any reasonable inspection desired by Company of the Facility and consultation with Seller, in the event there are issues identified that may have a material adverse effect on or may materially impair the short-term or long-

term operation of the Facility at the operational levels contemplated by this Agreement, for purposes of addressing such issues, Company may provide written recommendations for specific operation or maintenance actions or for changes in the operation or maintenance program of the Facility. Company's making or failing to make such recommendations shall not be construed as endorsing the operation and maintenance thereof or as any warranty of the safety, durability or reliability of the Facility nor as a waiver of any Company right. If Seller agrees with Company, Seller shall, within a reasonable time after Company makes such recommendations, not to exceed thirty (30) Days (or such longer period as reasonably agreed to by the Parties), implement Company's recommendations. If Seller disagrees with Company, it shall, within ten (10) Days, inform Company of alternatives it will take to accomplish the same intent, or provide Company with a reasonable explanation as to why no action is required by Good Engineering and Operating Practices. If Company disagrees with Seller's position, then the parties shall commission a study by a Qualified Consultant selected from among the entities listed in **Attachment D** (Consultants List) and the Qualified Consultant will make a recommendation to remedy the situation. Seller shall abide by the Qualified Consultant's recommendation contained in such study. Both Parties shall equally share in the cost for the Qualified Consultant. However, Seller shall pay all costs associated with implementing the recommendation contained in the Qualified Consultant's report. Notwithstanding the foregoing, Seller shall not be required to comply with any recommendations that, in Seller's reasonable judgment, will violate or void any warranties of equipment that is a part of, or used in connection with, the Facility or violate any long-term service agreement, or conflict with any written requirements, specifications or operating parameters of the manufacturer, with respect to such equipment; provided, that, in each such case, Seller shall promptly notify Company thereof, and Seller and Company shall endeavor to reach a mutually satisfactory resolution of the matter in question.

### **13.3. Manuals; Reports, Studies and Assessments.**

Seller shall provide Company with (a) any and all manufacturer's equipment manuals together with a copy of the operating and maintenance manual no later than the Commercial Operations Date; and (b) any updates, supplements and/or amendments thereto within three (3) Business Days after Seller's receipt of the same. In addition, throughout the Term, Seller shall deliver to Company, promptly upon Seller's receipt of the same, any reports, studies or assessments of the Facility prepared by an independent engineer for the benefit of the Seller.

### **13.4. Time Period for Maintaining Records.**

Any and all records, correspondence, memoranda and other documents or electronically recorded data related to the operation, maintenance and repair of the Facility shall be maintained by Seller for a period of not less than six (6) years.



## **ARTICLE 14**

### **CREDIT ASSURANCE AND SECURITY**

#### **14.1. Development Period Security.**

(a) **General.** To guarantee undertaking the performance of Seller's obligations under the Agreement for the period prior to the Commercial Operations Date (including but not limited to Seller's obligation to meet the Guaranteed Commercial Operations Date), Seller shall provide satisfactory development period security to Company in the amount equal to \$75 for each kilowatt of the Contract Capacity (the "**Development Period Security**"). Seller shall provide fifty percent (50%) of the Development Period Security to Company within ten (10) Days of the Execution Date of this Agreement, and the remaining fifty percent (50%) of the Development Period Security within ten (10) Business Days of the execution of the Interconnection Requirements Amendment.

(b) **Return of Development Period Security.** The Development Period Security shall be returned to Seller, subject to Company's right to draw from the Development Period Security as set forth in **Section 14.5** (Company's Right to Draw from Security Funds), in the following circumstances: (i) following Company's receipt of satisfactory Operating Period Security pursuant to **Section 14.2** (Operating Period Security) of this Agreement; or (ii) this Agreement is declared null and void pursuant to **Section 2.3** (Interconnection Requirements Study), **Section 3.4** (Prior to Effective Date), **Section 24.3** (Time Period for PUC Submittal Date), or **Section 24.4** (Time Period for PUC Approval).

#### **14.2. Operating Period Security.**

To guarantee the performance of Seller's obligations under the Agreement for the period starting from the Commercial Operations Date, Seller shall provide satisfactory operating period security to Company in the amount equal to \$125 for each kilowatt of the Contract Capacity (the "**Operating Period Security**"). Seller shall provide such Operating Period Security to Company within five (5) Business Days after the Commercial Operations Date, provided that, at all times, some form of Security Funds shall be in place and available to Company, whether Development Period Security or Operating Period Security.

#### **14.3. Form of Security.**

Seller shall supply the Development Period Security and Operating Period Security required in the form of an irrevocable standby letter of credit with no documentation requirement substantially in the form attached to this Agreement as **Attachment M** (Form of Letter of Credit) from a bank chartered in the United States with a credit rating of "A-" or better. If the rating (as measured by Standard & Poor's) of the bank issuing the standby letter of credit falls below A-, Company may require Seller to replace, within thirty (30) Days' notice by Company, the standby letter of credit with a standby letter of credit from another bank chartered in the United States with a credit rating of "A-" or better. Such letter of credit shall be issued for a minimum term of

one (1) year. Furthermore, at the end of each year, the security shall be renewed for an additional one (1) year term so that at the time of such renewal, the remaining term of any such security shall not be less than one (1) year. The letter of credit shall include a provision for at least thirty (30) Days advance notice to Company and Seller of any expiration or earlier termination of the letter of credit so as to allow Company sufficient time to exercise its rights under said security if Seller fails to extend or replace the security. In all cases, the reasonable costs and expenses of establishing, renewing, substituting, canceling, increasing, reducing, or otherwise administering the letter of credit shall be borne by Seller. In the event Company receives notice from the issuing bank that a letter of credit for the Development Period Security or Operating Period Security will be cancelled or is set to expire and will not be extended, Company shall endeavor, but shall not be obligated, to provide Seller with notice of such cancellation or termination. Company shall not be responsible for any lack of notice to Seller of such letter of credit's cancellation or termination and the events resulting therefrom, provided, however, that if Company draws upon the then full amount remaining under the letter of credit, the provisions of **Section 14.6** (Failure to Renew or Extend Letter of Credit) and **Section 14.7** (L/C Proceeds Escrow) shall apply. In the event the letter of credit for Development Period Security or Operating Period Security ever expires or is terminated without Company drawing on such full amount remaining under the letter of credit prior to its expiration, and Seller has not been afforded the opportunity to replace the letter of credit prior to its expiration or termination because of lack of notice, Seller shall be provided a grace period of five (5) Business Days from any notice of such expiration or termination of the letter of credit to obtain and provide to Company a substitute letter of credit meeting the requirements of this **Article 14** (Credit Assurance and Security).

#### **14.4. Security Funds.**

The Development Period Security and Operating Period Security, including L/C Proceeds therefrom (collectively, the "**Security Funds**") established, funded, and maintained by Seller pursuant to the provisions of this **Article 14** (Credit Assurance and Security) shall provide security for the performance of Seller's obligations under this Agreement and shall be available to be drawn on by Company as provided in **Section 14.5** (Company's Right to Draw from Security Funds). Seller shall maintain the Security Funds at the contractually-required level throughout the Term of this Agreement. Seller shall replenish the Security Funds to such required level within fifteen (15) Business Days after any draw on the Security Funds by Company or any reduction in the value of Security Funds below the required level for any other reason. Notwithstanding the foregoing, Seller's obligation to replenish the Development Period Security shall not exceed in total three (3) times the original amount of the Development Period Security required under **Section 14.1** (Development Period Security) of this Agreement.

#### **14.5. Company's Right to Draw from Security Funds.**

In addition to any other remedy available to it, Company may, before or after termination of this Agreement, draw from the Security Funds such amounts as are necessary to recover amounts Company is owed pursuant to this Agreement or the IRS Letter Agreement, including, without limitation, any damages due Company, any

relocation costs owed pursuant to **Attachment G** (Company-Owned Interconnection Facilities) and any amounts for which Company is entitled to indemnification under this Agreement. Company may, in its sole discretion, draw all or any part of such amounts due Company from any of the Security Funds to the extent available pursuant to this **Article 14** (Credit Assurance and Security), and from all such forms, and in any sequence Company may select. Any failure to draw upon the Security Funds or other security for any damages or other amounts due Company shall not prejudice Company's rights to recover such damages or amounts in any other manner.

#### **14.6. Failure to Renew or Extend Letter of Credit.**

If the letter of credit is not renewed or extended at least thirty (30) Days prior to its expiration or earlier termination, Company shall have the right to draw immediately upon the full amount of the letter of credit and to place the proceeds of such draw (the "**L/C Proceeds**"), at Seller's cost, in an escrow account in accordance with **Section 14.7** (L/C Proceeds Escrow), until and unless Seller provides a substitute letter of credit meeting the requirements of this **Article 14** (Credit Assurance and Security).

#### **14.7. L/C Proceeds Escrow.**

If Company draws on the letter of credit pursuant to **Section 14.6** (Failure to Renew or Extend Letter of Credit), and so long as a substitute letter of credit meeting the requirements of this **Article 14** (Credit Assurance and Security) is not obtained and provided to Company, Company shall, in order to avoid comingling the L/C Proceeds, have the right, but not the obligation, to place the L/C Proceeds in an escrow account as provided in this **Section 14.7** (L/C Proceeds Escrow) with a reputable escrow agent acceptable to Company ("**Escrow Agent**"). Without limiting the generality of the foregoing, a federally-insured bank shall be deemed to be a "reputable escrow agent." Company shall have the right to apply the L/C Proceeds as necessary to recover amounts Company is owed pursuant to this Agreement or the IRS Letter Agreement, including, without limitation, any damages due Company, any relocation costs owed pursuant to **Attachment G** (Company-Owned Interconnection Facilities) and any amounts for which Company is entitled to indemnification under this Agreement. To that end, the documentation governing such escrow account shall be in form and content satisfactory to Company and shall give Company the sole authority to draw from the account. Seller shall not be a party to such documentation and shall have no rights to the L/C Proceeds. Upon full satisfaction of Seller's obligations under this Agreement, including recovery by Company of amounts owed to it under this Agreement, Company shall instruct the Escrow Agent to remit to the bank that issued the letter of credit that was the source of the L/C Proceeds the remaining balance (if any) of the L/C Proceeds. If there is more than one escrow account with L/C Proceeds, Company may, in its sole discretion, draw on such accounts in any sequence Company may select. Any failure to draw upon the L/C Proceeds for any damages or other amounts due Company shall not prejudice Company's rights to recover such damages or amounts in any other manner. If a substitute letter of credit satisfying the requirements of this **Article 14** (Credit Assurance and Security) is obtained and provided to Company, the net L/C Proceeds remaining as of the date that such substitute letter of credit is provided, shall be returned to Seller, or as Seller directs in writing.

**14.8. Release of Security Funds.**

Promptly following the end of the Term, and the complete performance of all of Seller's obligations under this Agreement, including, but not limited to, the obligation to pay any and all amounts owed by Seller to Company under this Agreement, Company shall release the Security Funds to Seller.

## **ARTICLE 15 SALE AND ASSIGNMENT**

### **15.1. Sale of the Facility.**

Seller shall comply with the requirements of **Attachment P** (Sale of Facility by Seller) before Seller's right, title or interest in the Facility, in whole or in part, including a Change in Control, may be disposed of (other than the disposition of equipment in the ordinary course of operating and maintaining the Facility). Any attempt by Seller to make any such disposition or Change in Control without fulfilling the requirements of **Attachment P** (Sale of Facility by Seller) shall be deemed null and void and shall constitute an Event of Default pursuant to **Article 6** (Events of Default; Remedies; Termination).

### **15.2. Assignment by Seller.**

This Agreement may not be assigned by Seller without the prior written consent of Company (such consent not to be unreasonably withheld, conditioned or delayed), provided that Seller shall have the right, without the consent of Company, to assign its interest in this Agreement (a) to a wholly-owned subsidiary or to an affiliated company under common control with **[INSERT APPROPRIATE PARENT ENTITY]**, provided that such assignment does not impair the ability of Seller to perform its obligations under this Agreement; and (b) as collateral security for purposes of arranging or rearranging debt and/or equity financing for the Facility, or for sale-leaseback financing, to assign all or any part of its rights or benefits, but not its obligations, to any lender providing debt financing for the Facility. Seller shall promptly provide written notice to Company of any assignment of all or part of this Agreement and Seller shall provide to Company information about the assignee and the assignee's operational experience reasonably requested by Company. Company shall not be required to incur any duty or obligation as a result of, or in connection with, such assignment made without its consent beyond those duties and obligations set forth in this Agreement, unless otherwise agreed to by Company in writing.

### **15.3. Company's Acknowledgment.**

In connection with any assignment relating to the Facility Debt pursuant to **Section 15.2** (Assignment by Seller), Company shall, if requested by Seller and if its costs (including reasonable attorneys' fees of outside counsel) in responding to such request are paid by Seller: (a) execute and/or provide such Hawai'i-law-governed documents as may be reasonably requested by the Facility Lender, and reasonably acceptable to Company, including (i) to acknowledge (A) such assignment and/or pledge/mortgage, (B) the right of the Facility Lender to receive copies of notices of Events of Default where the Seller is the Defaulting Party and (C) the Facility Lender's reasonable opportunity to cure such Events of Default and to exercise remedies to assume Seller's obligations under this Agreement; and (ii) estoppel certificates as to Seller's and Company's compliance with the terms and conditions of this Agreement; and (b) provide a legal opinion as to the due authorization of such Company acknowledgment.

#### **15.4. Financing Document Requirements.**

Seller shall include in the terms of the Financing Documents as provisions for Company's benefit that provide that as a condition to the Facility Lender, or any purchaser, successor, assignee and/or designee of the Facility Lender ("**Subsequent Owner**"), succeeding to ownership or possession of the Facility as a result of the exercise of remedies under the Financing Documents, and thereafter operating the Facility to generate electric energy, such Facility Lender or Subsequent Owner shall, prior to operating the Facility for such purpose, have provided to Company, evidence reasonably acceptable to Company that such Subsequent Owner has (a) the qualifications, or has contracted with an entity having the qualifications, to operate the Facility in a manner consistent with the terms and conditions of this Agreement; and (b) assumed all of Seller's rights and obligations under this Agreement.

#### **15.5. Reimbursement of Company Costs.**

Seller shall reimburse Company for costs and expenses incurred by Company (including reasonable attorneys' fees of outside counsel) in responding to Facility Lender's requests or as a result of any event of default by Seller under the Financing Documents, including, but not limited to any assumption of Seller's obligations under **Section 15.4** (Financing Document Requirements).

#### **15.6. Assignment by Company.**

This Agreement shall not be assigned by Company without the prior written consent of Seller (which consent shall not be unreasonably withheld, conditioned or delayed); provided, however, that Company shall have the right, without the consent of Seller, to assign its interest in this Agreement to any affiliated company owned in whole or in part by HEI so long as such assignee (a) shall have assumed all obligations of Company under this Agreement; and (b) is a utility regulated by the PUC.

#### **15.7. Consequences for Failure to Comply.**

Any attempt to make any pledge, mortgage, grant of a security interest or collateral assignment for which consent is required under **Section 15.2** (Assignment by Seller) or **Section 15.6** (Assignment by Company) (as applicable), without fulfilling the requirements of this **Article 15** (Sale and Assignment) shall be null and void and shall constitute an Event of Default pursuant to **Article 6** (Events of Default; Remedies; Termination).

## **ARTICLE 16**

### **PERSONNEL AND SYSTEM SAFETY**

Notwithstanding any other provisions of this Agreement, if at any time Company reasonably determines that the Facility may endanger Company's personnel, and/or the continued operation of the Facility may endanger the integrity of the Company System or have an adverse effect on Company's other customers' electric service, Company shall have the right to disconnect the Facility from the Company System, as determined in the sole discretion of the Company System Operator. The Facility shall immediately comply with the dispatch instruction, which may be initiated through remote control, and shall remain disconnected (and in Seller-Attributable Unavailability status if so determined), until such time as Company is satisfied that the condition(s) referred to above have been corrected. If Company disconnects the Facility from the Company System for personnel or system safety reasons, it shall as soon as practicable notify Seller by telephone, and thereafter make reasonable efforts to confirm, in writing (with email being acceptable), within three (3) Days of the disconnection, the reasons for the disconnection. If the reason for the disconnection constitutes Seller-Attributable Unavailability, Company will notify Seller (a) whether the conditions resulting in such disconnection have been resolved (in which case no additional time after such confirmation shall count as Seller-Attributable Unavailability); or (b) that conditions resulting in such disconnection have not been resolved so that Seller can take such appropriate corrective actions. Seller shall notify Company in writing when such corrective action has been completed; provided, however, that Seller shall remain in Seller-Attributable Unavailability until Company is satisfied that the condition resulting in the disconnection has been corrected. Company shall use reasonable efforts to inspect such corrective measures (if necessary) and confirm the resolution of such condition within three (3) Business Days after Seller's notification.



## **ARTICLE 17**

### **FORCE MAJEURE**

#### **17.1. Definition of Force Majeure.**

The term “**Force Majeure**” as used in this Agreement means any occurrence that:

- (a) In whole or in part delays or prevents a Party’s performance under this Agreement;
- (b) Is not the direct or indirect result of the fault or negligence of that Party;
- (c) Is not within the control of that Party notwithstanding such Party having taken all reasonable precautions and measures in order to prevent or avoid such event; and
- (d) The Party has been unable to overcome by the exercise of due diligence.

#### **17.2. Events That Could Qualify as Force Majeure.**

Subject to the foregoing, events that could qualify as Force Majeure include, but are not limited to, the following:

- (a) acts of God, flooding, lightning, landslide, earthquake, fire, drought, explosion, epidemic, quarantine, storm, hurricane, tornado, volcano, other natural disaster or unusual or extreme adverse weather-related events;
- (b) war (declared or undeclared), riot or similar civil disturbance, acts of the public enemy (including acts of terrorism), sabotage, blockade, insurrection, revolution, expropriation or confiscation; or
- (c) except as set forth in **Section 17.3(i)**, strikes, work stoppage or other labor disputes (in which case the affected Party shall have no obligation to settle the strike or labor dispute on terms it deems unreasonable).

#### **17.3. Exclusions From Force Majeure.**

Force Majeure, however, does not include any of the following:

- (a) any acts or omissions of any third party, including, without limitation, any vendor, materialman, customer, or supplier of Seller, unless such acts or omissions are themselves caused by an event of Force Majeure;
- (b) any full or partial reduction in the availability of the Facility to provide the Energy Storage Services in response to Company Dispatch/Charge that is caused by or arises from either (i) a mechanical or equipment breakdown, or other mishaps, events or conditions attributable to normal wear and tear, unless such mishap is caused by Force Majeure; (ii) inherent flaws in the equipment/technology, equipment failure or equipment damage, unless such flaws, failure or damage are themselves



caused by Force Majeure; or (ii) any action or inaction of a third party, including but not limited to any vendor or supplier of the Seller or Company, except to the extent such action or inaction is due to Force Majeure;

(c) changes in market conditions that affect the cost of the Seller's supplies, or that otherwise render this Agreement uneconomic or unprofitable for the Seller;

(d) Seller's inability to obtain Governmental Approvals or Land Rights for the construction, ownership, operation or maintenance of the Facility, or Seller's loss of any such Governmental Approvals or Land Rights once obtained;

(e) Seller's inability to obtain sufficient fuel, power or materials to operate the Facility, except if Seller's inability to obtain sufficient power or materials is caused solely by an event of Force Majeure;

(f) Seller's failure to obtain additional funds, including funds authorized by a state or the federal government or agencies thereof, to supplement the payments made by Company pursuant to this Agreement;

(g) a Forced Outage except where such Forced Outage is caused by an event of Force Majeure;

(h) litigation or administrative or judicial action pertaining to Seller's interest in this Agreement, the Site, the Facility, the Land Rights, any Governmental Approvals, or the construction, ownership, operation or maintenance of the Facility, the Company-Owned Interconnection Facilities or the Company System; or

(i) a strike, work stoppage, or labor dispute limited only to any one or more of the Indemnified Seller Parties or any other third party employed by Seller to work on the Facility.

#### **17.4. Satisfaction of Certain Conditions.**

Subject to **Article 11** (Construction Period and Milestones), **Section 17.5** (Termination for Force Majeure) and **Section 17.6** (Effect of Force Majeure), if, because of Force Majeure, either Party is unable to perform its obligations under this Agreement, such Party shall be excused from whatever performance is affected by the Force Majeure only to the extent so affected; provided:

(a) the non-performing Party gives the other Party, no more than five (5) Days after the non-performing Party becomes aware or should have become aware of the Force Majeure condition or event, but in any event no later than thirty (30) Days after the Force Majeure condition or event begins, written notice (the "**Force Majeure Notice**") stating that the non-performing Party considers such condition or event to constitute Force Majeure and describing the particulars of such Force Majeure condition or event, including the date the Force Majeure commenced;

(b) the non-performing Party gives the other Party, within fourteen (14) Days after the Force Majeure Notice was or should have been provided, a written explanation of the Force Majeure condition or event and its effect on the non-

performing Party's performance, which explanation shall include evidence reasonably sufficient to establish that the occurrence constitutes Force Majeure;

(c) the suspension of performance is of no greater scope and of no longer duration than is required by the Force Majeure;

(d) the non-performing Party exercises commercially reasonable efforts to remedy its inability to perform and provides written weekly progress reports to the other Party describing actions taken to end the Force Majeure; and

(e) when the condition or event of Force Majeure ends and the non-performing Party is able to resume performance of its obligations under this Agreement, that Party shall give the other Party written notice to that effect.

### **17.5. Termination for Force Majeure.**

If Force Majeure delays or prevents a Party's performance for more than one hundred twenty (120) Days from the occurrence or inception of the Force Majeure, as stated in the Force Majeure Notice, and such delay or failure of performance would have otherwise constituted an Event of Default under **Article 6** (Events of Default; Remedies; Termination), the other Party shall have the right to terminate this Agreement by written notice. Such notice shall designate the date such termination is to be effective, which date shall be no later than thirty (30) Days after such notice is deemed to be received by the Party whose performance has been delayed or prevented. In the event of termination pursuant to this **Section 17.5** (Termination for Force Majeure), neither Party shall be liable for any damages or have any obligations to the other, except as provided in **Section 27.22** (Survival of Obligations) (but excluding **Section 27.22(b)**).

### **17.6. Effect of Force Majeure.**

Except as provided in **Article 11** (Construction Period and Milestones) and **Section 17.5** (Termination for Force Majeure), neither Party will be considered to be in default in the performance of any of its obligations set forth in this Agreement (except for obligations to pay money) when and to the extent failure of performance is caused by Force Majeure; provided, that a failure to make payments when due that accrued prior to the Force Majeure event shall not be excused.

### **17.7. No Relief of Other Obligations.**

Except as otherwise expressly provided for in this Agreement, the existence of a condition or event of Force Majeure shall not relieve the Parties of their obligations under this Agreement to the extent that performance of such obligations is not precluded by the condition or event of Force Majeure.

### **17.8. No Extension of Term.**

In no event will any delay or failure of performance caused by any conditions or events of Force Majeure extend this Agreement beyond its stated Term.

## **ARTICLE 18**

### **REPRESENTATIONS AND WARRANTIES**

#### **18.1. Representations and Warranties of Both Parties.**

As of the Execution Date and for the extent of the Term, each Party represents and warrants to the other Party that:

(a) Each respective Party has all necessary right, power and authority to execute, deliver and perform this Agreement; and

(b) The execution, delivery and performance of this Agreement by each respective Party will not result in a violation of any Laws, or conflict with, or result in a breach of, or cause a default under, any agreement or instrument to which such Party is also a party or by which it is bound. No consent of any person or entity not a Party to this Agreement, including any Governmental Authority (other than agencies whose approval is necessary for the development, construction, operation and maintenance of the Facility and the Company-Owned Interconnection Facilities or the PUC), is required for such execution, delivery and performance by either Party.

#### **18.2. Representations and Warranties of Seller.**

Seller represents and warrants to Company that:

(a) As of the Execution Date and for the extent of the Term, it is an entity in good standing with the Hawai'i Department of Commerce and Consumer Affairs and shall provide Company with a certified copy of a certificate of good standing by the Execution Date;

(b) As of the Execution Date, Seller is a subsidiary of [\_\_\_\_\_], a company with extensive experience developing, constructing, owning and operating utility-scale renewable energy generation facilities.

(c) Seller has obtained or will obtain Land Rights within the time periods set forth in **Section 10.2** (Land Rights for Facility);

(d) Seller shall have obtained, at the time legally required all Governmental Approvals necessary for the construction, ownership, operation and maintenance of the Facility; and

(e) As of the Commercial Operations Date and for the extent of the Term, Discharge Energy shall be delivered to Company free and clear of all liens, security interests, claims and encumbrances or any other interest therein or thereto by any person.

## **ARTICLE 19 LIMITATIONS**

### **19.1. Consequential Damages.**

NEITHER PARTY SHALL BE LIABLE FOR DAMAGES INCURRED BY THE OTHER PARTY FOR ANY LOSS OF PROFIT OR REVENUES, LOSS OF PRODUCT, LOSS OF USE OF PRODUCTS OR SERVICES OR ASSOCIATED EQUIPMENT, INTERRUPTION OF BUSINESS, COST OF CAPITAL, DOWNTIME COSTS, INCREASED OPERATING COSTS, OR FOR ANY SPECIAL, CONSEQUENTIAL, INCIDENTAL, INDIRECT OR PUNITIVE DAMAGES; PROVIDED, HOWEVER, THAT NOTHING IN THIS **SECTION 19.1** (CONSEQUENTIAL DAMAGES) SHALL LIMIT ANY OF (A) THE INDEMNIFICATION OBLIGATIONS OF EITHER PARTY UNDER **ARTICLE 20** (INDEMNIFICATION) OF THIS AGREEMENT; (B) THE LIABILITY OF EITHER PARTY FOR LIQUIDATED DAMAGES AS SET FORTH IN THIS AGREEMENT; (C) THE LIABILITY OF EITHER PARTY FOR DIRECT DAMAGES FOR BREACH OF THIS AGREEMENT AS AND TO THE EXTENT SUCH DAMAGES HAVE NOT BEEN LIQUIDATED AS SET FORTH IN THIS AGREEMENT; OR (D) THE LIABILITY OF EITHER PARTY FOR GROSS NEGLIGENCE OR INTENTIONAL MISCONDUCT.

### **19.2. No Representation by Company.**

Any review by Company of the Facility, including the design, construction or refurbishment, operation or maintenance of the Facility, or otherwise, is solely for Company's information. By making such review, Company makes no representation as to the economic and technical feasibility, operational capability, or reliability of the Facility, and Seller shall in no way represent to any third party that any such review by Company of the Facility, including, but not limited to, any review of the design, construction or renovation, operation, or maintenance of the Facility by Company, constitutes any such representation by Company. Seller is solely responsible for the economic and technical feasibility, operational capability, and reliability of the Facility.

## ARTICLE 20 INDEMNIFICATION

### 20.1. Indemnification of Company.

(a) **Third-Party Claims.** In addition to any other indemnification obligations Seller may have elsewhere in this Agreement, which are hereby incorporated in this **Section 20.1(a)** (Third-Party Claims), Seller shall indemnify, defend, and hold harmless Company, its successors, permitted assigns, affiliates, controlling persons, directors, officers, employees, agents, contractors, subcontractors and the employees of any of them (each, a “**Indemnified Company Party**”), from and against any Losses suffered, incurred or sustained by any Indemnified Company Party due to any Claim (whether or not well founded, meritorious or unmeritorious) by a third party not controlled by, or under common ownership and/or control with, Company relating to (i) the Energy Storage Services or Seller’s development, permitting, deployment, ownership, operation and/or maintenance of the Facility; or (ii) any actual or alleged personal injury or death or damage to property, in any way arising out of, incident to, or resulting directly or indirectly from the acts or omissions of any Indemnified Seller Party, except as and to the extent that such Loss is attributable to the negligence or willful misconduct of an Indemnified Company Party.

(b) **Compliance with Laws.** Any Losses incurred by an Indemnified Seller Party for noncompliance by Seller or an Indemnified Seller Party with applicable Laws shall not be reimbursed by Company but shall be the sole responsibility of Seller. Seller shall indemnify, defend and hold harmless each Indemnified Company Party from and against any and all Losses in any way arising out of, incident to, or resulting directly or indirectly from the failure of Seller to comply with any Laws.

(c) **Notice of Claim.** If Seller shall obtain knowledge of any Claim subject to **Section 20.1(a)** (Indemnification Against Third Party Claims), **Section 20.1(b)** (Compliance with Laws) or otherwise under this Agreement, Seller shall give prompt notice thereof to Company, and if Company shall obtain any such knowledge, Company shall give prompt notice thereof to Seller.

(d) **Indemnification Procedures.**

(i) In case any Claim subject to **Section 20.1(a)** (Indemnification Against Third Party Claims) or **Section 20.1(b)** (Compliance with Laws) or otherwise under this Agreement, shall be brought against an Indemnified Company Party, Company shall notify Seller of the commencement thereof and, provided that Seller has acknowledged in writing to Company its obligation to an Indemnified Company Party under this **Section 20.1** (Indemnification of Company), Seller shall be entitled, at its own expense, acting through counsel acceptable to Company, to participate in and, to the extent that Seller desires, to assume and control the defense thereof; provided, however, that Seller shall not compromise or settle a Claim against an Indemnified Company Party without the prior written consent of Company which consent shall not be unreasonably withheld or delayed.

(ii) Seller shall not be entitled to assume and control the defense of

any such Claim subject to **Section 20.1(a)** (Indemnification Against Third Party Claims), **Section 20.1(b)** (Compliance with Laws) or otherwise under this Agreement, if and to the extent that, in the sole opinion of Company, such Claim involves the potential imposition of criminal liability on an Indemnified Company Party or a conflict of interest between an Indemnified Company Party and Seller, in which case Company shall be entitled, at its own expense, acting through counsel acceptable to Seller to participate in any Claim, the defense of which has been assumed by Seller. Company shall supply, or shall cause an Indemnified Company Party to supply, Seller with such information and documents requested by Seller as are necessary or advisable for Seller to possess in connection with its participation in any Claim to the extent permitted by this **Section 20.1(d)(2)**. Company shall not enter, and shall restrict any Indemnified Company Party from entering, into any settlement or other compromise with respect to any Claim without the prior written consent of Seller, which consent shall not be unreasonably withheld or delayed.

**(iii)** Upon payment of any Losses by Seller, pursuant to this **Section 20.1** (Indemnification of Company) or other similar indemnity provisions contained herein, to or on behalf of Company, Seller, without any further action, shall be subrogated to any and all claims that an Indemnified Company Party may have relating thereto.

**(iv)** Company shall fully cooperate and cause all Company Indemnified Parties to fully cooperate, in the defense of or response to, any Claim subject to **Section 20.1** (Indemnification of Company).

## **20.2. Indemnification of Seller.**

**(a) Third-Party Claims.** Company shall indemnify, defend, and hold harmless Seller, its successors, permitted assigns, affiliates, controlling persons, directors, officers, employees, agents, contractors, subcontractors and their employees of any of them (each, a "**Indemnified Seller Party**"), from and against any Losses suffered, incurred or sustained by any Indemnified Seller Party due to any Claim (whether or not well founded, meritorious or unmeritorious) by a third party not controlled by or under common ownership and/or control with Seller relating to (i) the development, permitting, deployment, ownership, operation and/or maintenance of the Company-Owned Interconnection Facilities; or (ii) to any actual or alleged personal injury or death or damage to property, in any way arising out of, incident to, or resulting directly or indirectly from the acts or omissions of Company, except to the extent that any such Loss is attributable to the negligence or willful misconduct of an Indemnified Seller Party.

**(b) Compliance with Laws.** Any Losses incurred by an Indemnified Company Party for noncompliance by Company or an Indemnified Company Party with applicable Laws shall not be reimbursed by Seller but shall be the sole responsibility of Company. Company shall indemnify, defend and hold harmless each Indemnified Seller Party from and against any and all Losses in any way arising out of, incident to, or resulting directly or indirectly from the failure of Company to comply with any Laws.



**(c) Notice of Claim.** If Company shall obtain knowledge of any Claim subject to **Section 20.2(a)** (Indemnification Against Third Party Claims), **Section 20.2(b)** (Compliance with Laws) or otherwise under this Agreement, Company shall give prompt notice thereof to Seller, and if Seller shall obtain any such knowledge, Seller shall give prompt notice thereof to Company.

**(d) Indemnification Procedures.**

**(i)** In case any Claim subject to **Section 20.2(a)** (Indemnification Against Third Party Claims), **Section 20.2(b)** (Compliance with Laws), or otherwise under this Agreement, shall be brought against an Indemnified Seller Party, Seller shall notify Company of the commencement thereof and, provided that Company has acknowledged in writing to Seller its obligation to an Indemnified Seller Party under this **Section 20.2** (Indemnification of Seller), Company shall be entitled, at its own expense, acting through counsel acceptable to Seller, to participate in and, to the extent that Company desires, to assume and control the defense thereof; provided, however, that Company shall not compromise or settle a Claim against an Indemnified Seller Party without the prior written consent of Seller which consent shall not be unreasonably withheld or delayed.

**(ii)** Company shall not be entitled to assume and control the defense of any such Claim subject to **Section 20.2(a)** (Indemnification Against Third Party Claims), **Section 20.2(b)** (Compliance with Laws), or otherwise under this Agreement, if and to the extent that, in the opinion of Seller, such Claim involves the potential imposition of criminal liability on an Indemnified Seller Party or a conflict of interest between an Indemnified Seller Party and Company, in which case Seller shall be entitled, at its own expense, acting through counsel acceptable to Company, to participate in any Claim the defense of which has been assumed by Company. Seller shall supply, or shall cause an Indemnified Seller Party to supply, Company with such information and documents requested by Company as are necessary or advisable for Company to possess in connection with its participation in any Claim, to the extent permitted by this **Section 20.2(d)(2)**. Seller shall not enter, and shall restrict any Indemnified Seller Party from entering, into any settlement or other compromise with respect to any Claim without the prior written consent of Company, which consent shall not be unreasonably withheld or delayed.

**(iii)** Upon payment of any Losses by Company pursuant to this **Section 20.2** (Indemnification of Seller) or other similar indemnity provisions contained herein to or on behalf of Seller, Company, without any further action, shall be subrogated to any and all claims that an Indemnified Seller Party may have relating thereto.

**(iv)** Seller shall fully cooperate and cause all Seller Indemnified Parties to fully cooperate, in the defense of, or response to, any Claim subject to **Section 20.2** (Indemnification of Seller).

## **ARTICLE 21 INSURANCE**

### **21.1. Required Coverage.**

Seller, and anyone acting under its direction or control or on its behalf, shall, at its own expense, acquire and maintain, or cause to be maintained in full effect, commencing with the start of construction of the Facility, as applicable, and continuing throughout the Term, as applicable, the minimum insurance coverage set forth in **Attachment Q** (Required Insurance), or such higher amounts as the Seller and/or the Facility Lender reasonably determines to be necessary during construction and operation of the Facility. Seller's indemnity and other obligations shall not be limited by the foregoing insurance requirements.

### **21.2. Waiver of Subrogation.**

Seller, and anyone acting under its direction or control or on its behalf, shall cause its insurers to waive all rights of subrogation which Seller or its insurers may have against Company, Company's agents, or Company's employees.

### **21.3. Additional Insureds.**

The insurance policies specified in **Section 2** (General Liability Insurance), **Section 3** (Automobile Liability Insurance) and **Section 9** (Pollution Liability Insurance) of **Attachment Q** (Required Insurance) shall name Company as an additional insured, as its interests may appear, with respect to any and all third-party bodily injury and/or property damage claims, including completed operations, arising from Seller's performance of this Agreement, and Seller shall submit to Company a copy of such additional insured endorsement with evidence of insurance as required herein. Seller shall promptly, and in no event later than five (5) Days after such cancellation, modification or non-renewal, provide written notice to Company should any of the insurance policies required under this Agreement be cancelled, materially modified, or not renewed upon expiration. Company acknowledges that the Facility Lender shall be entitled to receive and distribute any and all loss proceeds as stipulated by any Financing Documents related to any policy described in this **Article 21** (Insurance) and **Attachment Q** (Required Insurance).

### **21.4. Evidence of Policies Provided to Company.**

Evidence of insurance for the coverage specified in this **Article 21** (Insurance) shall be provided to Company within thirty (30) Days after the Effective Date or prior to the start of construction, whichever shall first occur. Within thirty (30) Days of any change of any policy and upon renewal of any policy, Seller shall provide certificates of insurance to Company. Upon Company's reasonable request during the Term, Seller shall make available to Company for its inspection at Seller's designated location certified copies of the insurance policies described in this **Article 21** (Insurance) and **Attachment Q** (Required Insurance). Receipt of any evidence of insurance showing less coverage than requested is not a waiver of Seller's obligations to fulfill the



requirements.

### **21.5. Deductibles.**

Company acknowledges that any policy required herein may contain reasonable deductibles or self-insured retentions, the amounts of which will be reviewed for acceptance by Company. Acceptance will not be unreasonably withheld. Any deductible shall be the responsibility of Seller

### **21.6. Application of Proceeds from All Risk Property/Mechanical and Electrical Breakdown Insurance.**

Seller shall use commercially reasonable efforts to obtain provisions in the Financing Documents, on reasonable terms, providing for the insurance proceeds from All Risk Property/Mechanical and Electrical Breakdown Insurance to be applied to repair of the Facility.

### **21.7. Annual Review by Company.**

The coverage limits shall be reviewed annually by Company and if, in Company's discretion, Company determines that the coverage limits should be increased, Company shall so notify Seller. The amount of any increase of the coverage limits, when considered as a percentage of the then existing coverage limits, shall not exceed the cumulative amount of increase in the Consumer Price Index occurring after the coverage limits herein were last set. Seller shall, within thirty (30) Days of notice from Company, increase the coverage as directed in such notice and the costs of such increased coverage limits shall be borne by Seller.

### **21.8. No Representation of Coverage Adequacy.**

By requiring insurance herein, Company does not represent that coverage and limits will necessarily be adequate to protect Seller, and such coverage and limits shall not be deemed as a limitation on Seller's liability under the indemnities granted to Company in this Agreement.

### **21.9. Subcontractors.**

Seller shall ensure that each of its subcontractors is either (a) named as an additional insured under the insurance policies procured by Seller; or (b) separately covered by insurance policies equivalent in type and monetary limits as those required of Seller. All such insurance shall be provided at the sole cost of Seller or its subcontractor.

### **21.10. General Insurance Requirements.**

Each policy shall be specifically endorsed by blanket or otherwise to provide that Seller's insurance is primary. Any other insurance carried by Company will be excess only and not contribute with this insurance. Each policy is to be written by an insurer with a rating by A.M. Best Company, Inc. of "A-VII" or better. If coverage is written on a claims-made basis, Seller warrants that any retroactive date applicable to coverage

under the policy is equal to or prior to the Execution Date; and that continuous coverage will be maintained or an extended discovery period will be exercised for a period of three (3) years beginning from the end of the Term. If the limits of available liability coverage required herein become substantially reduced as a result of claim payments, Seller shall promptly, and in no event later than thirty (30) Days after such substantial reduction, at its own expense, purchase additional liability insurance (if such coverage is available at commercially reasonable rates) to increase the amount of available coverage to the limits of liability coverage required herein.

## **ARTICLE 22**

### **REVISIONS TO PERFORMANCE STANDARDS**

#### **22.1. Revisions to Performance Standards.**

The Parties acknowledge that, during the Term, certain Performance Standards and Telemetry and Control interfaces may be revised or added to facilitate necessary improvements in integrating energy storage resources into the Company System and operations. Such revisions or additions may be attributable to, without limitation, the following: changes in the Company System, changes in communications and control platforms, changes in system protection requirements, changes to the state of commercially available technology, changes in customer electrical usage (such as changes in average hourly load profiles) and changes in Laws (e.g., new environmental constraints, which may limit Company's ability to start/stop its generators in response to integration of intermittent generation, or constraints impacting the power quality standards for the Company System, such as constraints imposed by HERA or by the PUC under the HERA Law). Changes in Facility characteristics achieved through control system configuration, settings, or other tunable parameters shall not be considered a revision to performance standards. These types of changes should be implemented by Seller in response to Company request unless it can be shown that the changes negatively impact Seller's ability to meet its obligations under this Agreement.

#### **22.2. Performance Standards Information Request.**

If Company reasonably concludes that a Performance Standards Revision is necessary or important for the operation of the Company System and is capable of being complied with by Seller, Company shall have the right to issue to Seller a Performance Standards Information Request with respect to such Performance Standards Revision. Seller shall, within a reasonable period of time following Seller's receipt of such Performance Standards Information Request, but in no event more than ninety (90) Days after Seller's receipt of such request (or such other period of time as Company and Seller may agree in writing), submit to Company a Performance Standards Proposal responsive to the Performance Standards Revision proposed in such Performance Standards Information Request.

#### **22.3. Performance Standards Proposal.**

Upon receipt of a Performance Standards Proposal submitted in response to a Performance Standards Information Request, Company will evaluate such Performance Standards Proposal and Seller shall assist Company in performing such evaluation as and to the extent reasonably requested by Company (including, but not limited to, providing such additional information as Company may reasonably request and participating in meetings with Company as Company may reasonably request). Company shall have no obligation to evaluate a Performance Standards Proposal submitted at Seller's own initiative.

#### **22.4. Performance Standards Revision Document.**

If, following Company's evaluation of a Performance Standards Proposal, Company desires to consider implementing the Performance Standards Revision addressed in such Proposal, Company shall provide Seller with written notice to that effect, such notice to be issued to Seller within one hundred eighty (180) Days of receipt of the Performance Standards Proposal, and Company and Seller shall proceed to negotiate in good faith a Performance Standards Revision Document setting forth the specific changes to the Agreement that are necessary to implement such Performance Standards Revision. A decision by Company to initiate negotiations with Seller as aforesaid shall not constitute an acceptance by Company of any of the details set forth in Seller's Performance Standards Proposal for the Performance Standards Revision in question, including, but not limited to, the Performance Standards Modifications and the Performance Standards Pricing Impact. Any adjustment to the payments due from Company under this Agreement pursuant to such Performance Standards Revision Document shall be limited to the Performance Standards Pricing Impact (other than with respect to the financial consequences of non-performance as to a Performance Standards Revision). The time periods set forth in such Performance Standards Revision Document as to the effective date for the Performance Standards Revision shall be measured from the date the PUC Performance Standards Revision Order becomes non-appealable, as provided in **Section 22.6** (PUC Performance Standards Revision Order).

#### **22.5. Failure to Reach Agreement.**

If Company and Seller are unable to agree upon and execute a Performance Standards Revision Document within one hundred eighty (180) Days of Company's written notice to Seller pursuant to **Section 22.4** (Performance Standards Revision Document), Company shall have the option of declaring the failure to reach agreement on and execute such Performance Standards Revision Document to be a dispute and submit such dispute to an Independent Evaluator for the conduct of a determination pursuant to **Section 22.10** (Dispute) of this Agreement. Any decision of the Independent Evaluator, rendered as a result of such dispute shall include a form of a Performance Standards Revision Document as described in **Section 22.4** (Performance Standards Revision Document).

#### **22.6. PUC Performance Standards Revision Order.**

No Performance Standards Revision Document shall constitute an amendment to the Agreement unless and until a PUC Performance Standards Revision Order issued with respect to such document has become non-appealable. Once the condition of the preceding sentence has been satisfied, such Performance Standards Revision Document shall constitute an amendment to this Agreement. To be "non-appealable" under this **Section 22.6** (PUC Performance Standards Revision Order), such PUC Performance Standards Revision Order shall be either (a) not subject to appeal to any Circuit Court of the State of Hawai'i or the Supreme Court of the State of Hawai'i, because the thirty (30) Day period (accounting for weekends and holidays as appropriate) permitted for such an appeal has passed without the filing of notice of such an appeal; or (b) affirmed on appeal to any Circuit Court of the State of Hawai'i

or the Supreme Court, or the Intermediate Appellate Court upon assignment by the Supreme Court, of the State of Hawai'i, or affirmed upon further appeal or appellate process, and is not subject to further appeal, because the jurisdictional time permitted for such an appeal (and/or further appellate process such as a motion for reconsideration or an application for writ of certiorari) has passed without the filing of notice of such an appeal (or the filing for further appellate process).

## **22.7. Company's Rights.**

The rights granted to Company under **Section 22.4** (Performance Standards Revision Document) and **Section 22.5** (Failure to Reach Agreement) above are exclusive to Company. Seller shall not have a right to initiate negotiations of a Performance Standards Revision Document or to initiate dispute resolution under **Section 22.10** (Dispute), as a result of a failure to agree upon and execute any Performance Standards Revision Document.

## **22.8. Seller's Obligation.**

Notwithstanding any provision of this **Article 22** (Revisions to Performance Standards) to the contrary, Seller shall have no obligation to respond to more than one (1) Performance Standards Information Request during any twelve (12) month period.

## **22.9. Limited Purpose.**

This **Article 22** (Revisions to Performance Standards) is intended to specifically address necessary revisions to the Performance Standards and Telemetry and Control interfaces to enhance integration of energy storage resources onto the Company System, or to comply with future Laws which may be driven in part by higher integration of energy storage resources, and is not intended for either Party to provide a means for renegotiating any other terms of this Agreement. Revisions to the Performance Standards in accordance with the provisions of this **Article 22** (Revisions to Performance Standards) are not intended to materially increase Seller's risk of non-performance or default.

## **22.10. Dispute.**

If Company decides to declare a dispute as a result of the failure to reach agreement and execute a Performance Standards Revision Document pursuant to **Section 22.5** (Failure to Reach Agreement), it shall provide written notice to that effect to Seller. Within twenty (20) Days of delivery of such notice Seller and Company shall agree upon an Independent Evaluator to resolve the dispute regarding a Performance Standards Revision Document. The Independent Evaluator shall be reasonably qualified and expert in battery energy storage systems, matters relating to the Performance Standards, financing, and energy storage services agreements. If the Parties are unable to agree upon an Independent Evaluator within such 20-Day period, Company shall apply to the PUC for the appointment of an Independent Evaluator. If an Independent Observer retained under the Competitive Bidding Framework is qualified and willing and available to serve as Independent Evaluator, the PUC shall appoint one of the persons or entities qualified to serve as an

Independent Observer to be the Independent Evaluator; if not, the PUC shall appoint another qualified person or entity to serve as Independent Evaluator. In its application, Company shall ask the PUC to appoint an Independent Evaluator within thirty (30) Days of the application.

**(a)** Promptly upon appointment, the Independent Evaluator shall request the Parties to address the following matters within the next fifteen (15) Days:

- (i)** The Performance Standard Revision(s);
- (ii)** The technical and operational feasibility of complying with the Performance Standard Revision(s) and likelihood of compliance;
- (iii)** How Seller would comply with the Performance Standard Revision(s);
- (iv)** Reasonably expected net costs and/or lost revenues associated with the Performance Standards Revision(s);
- (v)** The appropriate level, if any, of Performance Standards Pricing Impact in light of the foregoing; and
- (vi)** Contractual consequences for non-performance that are commercially reasonable under the circumstances.

**(b)** Within ninety (90) Days of appointment, the Independent Evaluator shall render a decision unless the Independent Evaluator determines it needs to have additional time, not to exceed forty-five (45) Days, to render a decision.

**(c)** The Parties shall assist the Independent Evaluator throughout the process of preparing its review, including making key personnel and records available to the Independent Evaluator, but neither Party shall be entitled to participate in any meetings with personnel of the other Party or review of the other Party's records. However, the Independent Evaluator will have the right to conduct meetings, hearings or oral arguments in which both Parties are represented. The Parties may meet with each other during the review process to explore means of resolving the matter on mutually acceptable terms.

**(d)** The following standards shall be applied by the Independent Evaluator in rendering his or her decision: (i) if it is not technically or operationally feasible for Seller to comply with a Performance Standard Revision, the Independent Evaluator shall determine that the Agreement shall not be amended to incorporate such Performance Standard Revision (unless the Parties agree otherwise); (ii) if it is technically or operationally feasible for Seller to comply with a Performance Standard Revision, the Independent Evaluator shall incorporate such Performance Standard Revision into a Performance Standards Revision Document including (A) Seller's Performance Standards Modifications; (B) pricing terms that incorporate the Performance Standards Pricing Impact; and (C) contract terms and conditions that are commercially reasonable under the circumstances, especially with respect to the consequences of non-performance by Seller as to the Performance Standards

Revision(s). In addition to the Performance Standards Revision Document, the Independent Evaluator shall render a decision which sets forth the positions of the Parties and Independent Evaluator's rationale for his or her decisions on disputed issues.

(e) The fees and costs of the Independent Evaluator shall be paid by Company up to the first \$30,000 of such fees and costs; above those amounts, the Party that is not the prevailing Party shall be responsible for any such fees and costs; provided, that, if neither Party is the prevailing Party, the fees and costs of the Independent Evaluator above \$30,000 shall be borne equally by the Parties. The Independent Evaluator in rendering his or her decision shall also state which Party prevailed over the other Party, or that neither Party prevailed over the other.

### **22.11. HERA Law.**

The provisions of this **Article 22** (Revisions to Performance Standards) are without limitation to the obligations of the Parties under the HERA Law and the reliability standards and interconnection requirements developed and adopted by the PUC pursuant to the HERA Law.



## **ARTICLE 23**

### **FINANCIAL COMPLIANCE**

#### **23.1. Financial Compliance.**

Seller shall provide or cause to be provided to Company on a timely basis, as reasonably determined by Company, all information, including but not limited to information that may be obtained in any audit referred to below (the “**Financial Compliance Information**”), reasonably requested by Company for purposes of permitting Company and its parent company, HEI, to comply with the requirements (initial and on-going) of (a) the accounting principles of Financial Accounting Standards Board (“**FASB**”) Accounting Standards Codification 810, Consolidation (“**FASB ASC 810**”); (b) the accounting principles of FASB ASC 842 Leases (“**FASB ASC 842**”); (c) Section 404 of the Sarbanes-Oxley Act of 2002 (“**SOX 404**”); and (c) all clarifications, interpretations and revisions of and regulations implementing FASB ASC 810, FASB ASC 842, and SOX 404, issued by the FASB, Securities and Exchange Commission, the Public Company Accounting Oversight Board, Emerging Issues Task Force or other Governmental Authorities. In addition, if required by Company in order to meet its compliance obligations, Seller shall allow Company or its independent auditor to audit, to the extent reasonably required, Seller’s financial records, including its system of internal controls over financial reporting; provided, however, that Company shall be responsible for all costs associated with the foregoing, including but not limited to Seller’s reasonable internal costs. Company shall limit access to such Financial Compliance Information to persons involved with such compliance matters and restrict persons involved in Company’s monitoring, dispatch or scheduling of Seller and/or Facility, or the administration of this Agreement, from having access to such Financial Compliance Information (unless approved in writing in advance by Seller).

#### **23.2. Confidentiality.**

Company shall, and shall cause HEI to, maintain the confidentiality of the Financial Compliance Information as provided in this **Article 23** (Financial Compliance). Company may share the Financial Compliance Information on a confidential basis with HEI and the independent auditors and attorneys for HEI. (Company, HEI, and their respective independent auditors and attorneys are collectively referred to in this **Article 23** (Financial Compliance) as “**Recipient**.”) If either Company or HEI, in the exercise of their respective reasonable judgments, concludes that consolidation or financial reporting with respect to Seller and/or this Agreement is necessary, Company and HEI each shall have the right to disclose such of the Financial Compliance Information as Company or HEI, as applicable, reasonably determines is necessary to satisfy applicable disclosure and reporting or other requirements and give Seller prompt written notice thereof (in advance, to the extent practicable under the circumstances). If Company or HEI disclose Financial Compliance Information pursuant to the preceding sentence, Company and HEI shall, without limitation to the generality of the preceding sentence, have the right to disclose Financial Compliance Information to the PUC and the Division of Consumer Advocacy of the Department of Commerce and Consumer Affairs of the State of Hawai‘i in connection with the PUC’s rate making activities for Company and other HEI-affiliated entities; provided, that, if



the scope or content of the Financial Compliance Information to be disclosed to the PUC exceeds or is more detailed than that disclosed pursuant to the preceding sentence, such Financial Compliance Information will not be disclosed until the PUC first issues a protective order to protect the confidentiality of such Financial Compliance Information. Neither Company nor HEI shall use the Financial Compliance Information for any purpose other than as permitted under this **Article 23** (Financial Compliance).

### **23.3. Required Disclosure.**

In circumstances other than those addressed in **Section 23.2** (Confidentiality), if any Recipient becomes legally compelled under applicable Laws or by legal process (e.g., deposition, interrogatory, request for documents, subpoena, civil investigative demand or similar process) to disclose all or a portion of the Financial Compliance Information, such Recipient shall undertake reasonable efforts to provide Seller with prompt notice of such legal requirement prior to disclosure so that Seller may seek a protective order or other appropriate remedy and/or waive compliance with the terms of this **Article 23** (Financial Compliance). If such protective order or other remedy is not obtained, or if Seller waives compliance with the provisions at this **Article 23** (Financial Compliance), Recipient shall furnish only that portion of the Financial Compliance Information which it is legally required to so furnish and to use reasonable efforts to obtain assurance that confidential treatment will be accorded to any disclosed material.

### **23.4. Exclusions from Confidentiality.**

The obligation of nondisclosure and restricted use imposed on each Recipient under this **Article 23** (Financial Compliance) shall not extend to any portion(s) of the Financial Compliance Information which (a) was known to such Recipient prior to receipt; (b) without the fault of such Recipient, is available or becomes available to the general public; or (c) is received by such Recipient from a third party not bound by an obligation or duty of confidentiality.

### **23.5. Consolidation.**

Company does not want to be subject to consolidation as set forth in FASB ASC 810, as issued and amended from time to time by FASB.

**(a) Consolidation.** Company represents that, as of the Execution Date, it is not required to consolidate Seller into its financial statements in accordance with relevant accounting guidance under U.S. generally accepted accounting principles (“GAAP”). If, due to a change in applicable law or accounting guidance under U.S. GAAP, or as a result of a material amendment to the Agreement, in each case, after the Execution Date, Company determines, in its sole but good faith discretion, that it is required to consolidate Seller into its financial statements in accordance with relevant accounting guidance in accordance with U.S. GAAP, then Seller, upon Company’s written request, shall, as soon as reasonably practicable (but in no event longer than fifteen (15) Days) provide audited financial statements (including footnotes) in accordance with U.S. GAAP (and as of the reporting periods Company is

required to report thereafter) in order for Company to consolidate and file its financial statements within the reporting deadlines of the Securities and Exchange Commission; provided, however, that if Seller does not normally prepare audited financial statements for the periods requested, Company shall reimburse Seller fifty percent (50%) of the reasonable costs of having necessary audits performed and preparation of the audited financial statement; provided, further that the foregoing reimbursement shall only apply if Seller normally prepares financial statements on an annual basis. Notwithstanding the foregoing requirement that Seller provide audited financial statements to Company, the Parties will take all commercially reasonable steps, which may include modification of this Agreement to eliminate the consolidation treatment, while preserving the economic “benefit of the bargain” to both Parties. If the Parties are unable to eliminate the consolidation treatment by other means, the Parties shall effectuate a sale of the Facility to Company for an amount equal to the greater of: (i) the Make Whole Amount determined pursuant to **Section 6** (Make Whole Amount) of **Attachment P** (Sale of Facility by Seller) or (ii) the fair market value determined pursuant to **Section 3** (Procedure to Determine Fair Market Value of the Facility) of **Attachment P** (Sale of Facility by Seller), in either case under a Purchase and Sale Agreement to be negotiated based on the terms and conditions set forth in **Section 4** (Purchase and Sale Agreement) of **Attachment P** (Sale of Facility by Seller).

(b) **Reserved.**

(c) **Reserved.**

## **ARTICLE 24**

### **REGULATORY APPROVAL**

#### **24.1. General.**

This Agreement is subject to approval by the PUC in the form of a satisfactory PUC Approval Order and the Parties' respective obligations hereunder are conditioned upon receipt of such approval, except as specifically provided otherwise herein. Upon the Execution Date of this Agreement, the Parties shall use good faith efforts to obtain, as soon as practicable, a PUC Approval Order that satisfies the requirements of **Section 24.5(a)** (PUC Approval Order). Company shall submit to the PUC an application for a satisfactory PUC Approval Order but does not extend any assurances that a PUC Approval Order will ultimately be obtained. As requested by Company, Seller will provide reasonable cooperation to support Company in obtaining a PUC Approval Order, including timely providing information requested by Company to support its application, including information for Company and its consultant to conduct a greenhouse gas emissions analysis for the PUC application, as well as information requested by the PUC and parties to the PUC proceeding in which approval is being sought. Seller understands that lack of cooperation may result in Company's inability to file an application with the PUC and/or a failure to receive a PUC Approval Order. For the avoidance of doubt, Company has no obligation to seek reconsideration, appeal, or other administrative or judicial review of any Unfavorable PUC Order. The Parties agree that neither Party has control over whether a PUC Approval Order will be issued and each Party hereby assumes any and all risks arising from, or relating in any way to, the inability to obtain a satisfactory PUC Approval Order and hereby releases the other Party from any and all claims relating thereto.

#### **24.2. Seller Participation.**

Seller shall seek participation without intervention in the PUC docket for approval of this Agreement pursuant to applicable rules and orders of the PUC. The scope of Seller's participation shall be determined by the PUC. However, Seller expressly agrees to seek participation for the limited purpose and only to the extent necessary to assist the PUC in making an informed decision regarding the approval of this Agreement. If Seller chooses not to seek participation in the docket, Seller expressly agrees and knowingly waives the right to claim, before the PUC, in any court, arbitration or other proceeding, that the information submitted and the arguments offered by Company in support of the application requesting the PUC Approval Order are insufficient to meet Company's burden of justifying that the terms of this Agreement are just and reasonable and in the public interest, or otherwise deficient in any manner for purposes of supporting the PUC's approval of this Agreement. Seller shall not seek in the docket and Company shall not disclose any confidential information to Seller that would provide Seller with an unfair business advantage or would otherwise harm the position of others with respect to their ability to compete on equal and fair terms.

### **24.3. Time Period for PUC Submittal Date.**

If the PUC Submittal Date has not occurred within one hundred twenty (120) Days of the Execution Date, or such longer period as Company and Seller may agree to by a subsequent written agreement, Company may, by written notice delivered within thirty (30) Days of the expiration of such period, declare the Agreement null and void if the reason the application has not been filed is (a) any one or more of the conditions set forth in **Section 3.4** (Prior to Effective Date); or (b) Seller's failure to provide in a timely manner information reasonably requested by Company to support such application.

### **24.4. Time Period for PUC Approval.**

If the Commission issues an Unfavorable PUC Order or if a PUC Approval Order is not issued within twelve (12) months of the PUC Submittal Date, or within such longer period as Company and Seller may agree to by a written agreement ("**PUC Approval Time Period**"), then Company or Seller may, by written notice delivered within one hundred and eighty (180) Days of (a) in the case that an Unfavorable PUC Order has been issued, the date the Unfavorable PUC Order becomes non-appealable, or (b) in the case that a PUC Approval Order is not issued within twelve (12) months of the PUC Submittal Date, or the expiration of the PUC Approval Time Period, as applicable, declare this Agreement null and void. If a PUC Approval Order or an Unfavorable PUC Order is issued within the PUC Approval Time Period but that order is appealed, and a Non-Appealable PUC Approval Order is not obtained by the longer of (i) twenty-four (24) months of the PUC Submittal Date, (ii) eighteen (18) months from the filing of such appeal, or (iii) within such longer period as Company and Seller may agree to by a subsequent written agreement (the "**PUC Order Appeal Period**"), then Company or Seller may, by written notice delivered within ninety (90) Days after the expiration of the PUC Order Appeal Period, declare this Agreement null and void.

### **24.5. Regulatory Approval Terms.**

(a) **PUC Approval Order.** The term "**PUC Approval Order**" means an order from the PUC that does not contain terms and conditions deemed to be unacceptable by Company, and is in a form deemed to be reasonable by Company, in its sole, but nonarbitrary, discretion, ordering that:

- (i) this Agreement is approved;
- (ii) Company is authorized to include the purchased energy storage costs (and related revenue taxes) that Company incurs under this Agreement in Company's Energy Cost Recovery Clause or equivalent, to the extent such costs are not included in base rates for the Term;
- (iii) Company is authorized to include the Lump Sum Payment that Company incurs under this Agreement in Company's Purchase Power Adjustment Clause, to the extent such costs are not included in Base Rates for the Term;
- (iv) The purchased energy storage costs to be incurred by Company as a result of this Agreement are reasonable; and

(v) Company's energy storage arrangements under this Agreement, pursuant to which Company will purchase the availability of the Facility's Energy Storage Services from Seller, are prudent and in the public interest.

(b) **Non-Appealable PUC Approval Order.** The term "**Non-Appealable PUC Approval Order**" means a PUC Approval Order (i) that is not subject to appeal to any Circuit Court of the State of Hawai'i, Intermediate Court of Appeals of the State of Hawai'i, or the Supreme Court of the State of Hawai'i, because the period permitted for such an appeal (the "**Appeal Period**") has passed without the filing of notice of such an appeal; or (ii) that was affirmed on appeal to any Circuit Court of the State of Hawai'i, Intermediate Court of Appeals of the State of Hawai'i, or the Supreme Court of the State of Hawai'i, or was affirmed upon further appeal or appellate process, and that is not subject to further appeal, because the jurisdictional time permitted for such an appeal and/or further appellate process such as a motion for reconsideration or an application for writ of certiorari has passed without the filing of notice of such an appeal or the filing for further appellate process.

(c) **Company's Written Statement.** Not later than thirty-five (35) Days after the issuance of a PUC order approving this Agreement, Company shall provide Seller with a copy of such order together with a written statement as to whether the conditions set forth in **Section 24.5(a)** (PUC Approval Order) have been met and the order constitutes a PUC Approval Order. If Company's written statement declares that the conditions set forth in **Section 24.5(a)** (PUC Approval Order) have been satisfied, the date of the issuance of the PUC Approval Order shall be the "**PUC Approval Order Date.**"

(d) **Non-Appealable PUC Approval Order Date.** If Company provides the written statement referred to in **Section 24.5(c)** (Company's Written Statement) to the effect that the conditions referred to in **Section 24.5(a)** (PUC Approval Order) have been satisfied, the term "**Non-Appealable PUC Approval Order Date**" shall be defined as follows:

(i) If a PUC Approval Order is issued and is not made subject to a motion for reconsideration or clarification filed with the PUC or an appeal, the Non-Appealable PUC Approval Order Date shall be the date one (1) Day after the expiration of the Appeal Period following the issuance of the PUC Approval Order, or the date of Company's written statement as required under **Section 24.5(c)** (Company's Written Statement), whichever is later;

(ii) If the PUC Approval Order became subject to a motion for reconsideration or clarification, and the motion for reconsideration or clarification is denied or the PUC Approval Order is affirmed after reconsideration or clarification, and such order is not made subject to an appeal, the Non-Appealable PUC Approval Order Date shall be deemed to be the date one (1) Day after the expiration of the Appeal Period following the order denying reconsideration of or affirming the PUC Approval Order; or

(iii) If the PUC Approval Order, or an order denying reconsideration or clarification of the PUC Approval Order or affirming approval of the PUC Approval Order after reconsideration, becomes subject to an appeal, then the Non-Appealable

PUC Approval Order Date shall be the date upon which the PUC Approval Order becomes a non-appealable order within the meaning of the definition of a Non-Appealable PUC Approval Order in **Section 24.5(b)** (Non-Appealable PUC Approval Order).

**(e) Unfavorable PUC Order.** The term “**Unfavorable PUC Order**” means an order from the PUC concerning this Agreement that: (i) dismisses Company’s application; (ii) denies Company’s application; or (iii) approves Company’s application but contains terms and conditions deemed unacceptable by Company in its sole discretion and therefore does not meet the definition of a PUC Approval Order as set forth in **Section 24.5(a)** (PUC Approval Order).

## **ARTICLE 25 EQUAL EMPLOYMENT OPPORTUNITY**

### **25.1. Equal Employment Opportunity.**

(Applicable to all contracts of \$10,000 or more in the whole or aggregate. 41 CFR 60-1.4 and 41 CFR 60-741.5.) Seller is aware of and is fully informed of Seller's responsibilities under Executive Order 11246 (reference to which include amendments and orders superseding in whole or in part) and shall be bound by and agrees to the applicable provisions as contained in Section 202 of said Executive Order and the Equal Opportunity Clause as set forth in 41 CFR 60-1.4 and 41 CFR 60-741.5(a), which clauses are hereby incorporated by reference.

### **25.2. Equal Opportunity for Disabled Veterans, Recently Separated Veterans, Other Protected Veterans and Armed Forces Service Medal Veterans.**

(Applicable to (i) contracts of \$25,000 or more entered into before December 31, 2003 (41 CFR 60-250.4) or (ii) each federal government contract of \$100,000 or more, entered into or modified on or after December 31, 2003 (41 CFR 60-300.4) for the purchase, sale or use of personal property or nonpersonal services (including construction).) If applicable to Seller under this Agreement, Seller agrees that it is, and shall remain, in compliance with the rules and regulations promulgated under The Vietnam Era Veterans Readjustment Assistance Act of 1974, as amended by the Jobs for Veterans Act of 2002, including the requirements of 41 CFC 60-250.5(a) (for orders/contracts entered into before December 31, 2003) and 41 CFR 60-300.5(a) (for orders/contracts entered into or modified on or after December 31, 2003) which are incorporated into this Agreement by reference.



## **ARTICLE 26**

### **DISPUTE RESOLUTION**

#### **26.1. Good Faith Negotiations.**

Except as otherwise expressly set forth in this Agreement, before submitting any Dispute under this Agreement to the dispute resolution procedures set forth in **Section 26.2** (Dispute Resolution Procedures), the presidents, vice presidents, or authorized delegates from both Seller and Company having full authority to settle the Dispute(s), shall personally meet in Hawai'i and attempt in good faith to resolve the Dispute(s) ("**Management Meeting**"), within thirty (30) Days after a request by either Party.

#### **26.2. Dispute Resolution Procedures.**

Except as otherwise expressly set forth in this Agreement and subject to **Section 26.1** (Good Faith Negotiations), any and all Dispute(s) arising out of or relating to this Agreement (a) which remain unresolved for a period of twenty (20) Days after the Management Meeting takes place; or (b) for which the Parties fail to hold a Management Meeting within sixty (60) Days of the date that a Management Meeting was requested by a Party, may upon the agreement of the Parties, first be submitted to confidential mediation in Honolulu, Hawai'i, pursuant to the administration by, and in accordance with the Mediation Rules, Procedures and Protocols of, Dispute Prevention & Resolution, Inc. (or its successor) or, in their absence, the American Arbitration Association ("**DPR**") then in effect. If the Parties agree to submit the dispute to confidential mediation, the Parties shall each pay fifty percent (50%) of the cost of the mediation (i.e., the fees and expenses charged by the mediator and DPR) and shall otherwise each bear their own costs and attorney's fees. If the Parties do not submit the Dispute(s) to mediation, or if they do submit the Dispute(s) to mediation but settlement of the Dispute(s) is not reached within sixty (60) Days after commencement of the mediation, either Party may initiate legal proceedings in a court of competent jurisdiction in the State of Hawai'i. Notwithstanding the foregoing, the provisions of this **Article 26** (Dispute Resolution) shall not apply to any Dispute within the authority of an Independent Evaluator under **Article 22** (Revisions to Performance Standards) or **Attachment S** (Monthly Reporting and Dispute Resolution by Independent Evaluator).

#### **26.3. Document Retention.**

If either party initiates dispute resolution under this **Article 26** (Dispute Resolution), then each Party must retain and preserve all records, including documents, which may be relevant to such Dispute, in accordance with applicable Laws until such Dispute is resolved.



## **ARTICLE 27 MISCELLANEOUS**

### **27.1. Amendments.**

Any amendment or modification of this Agreement or any part hereof shall not be valid unless in writing and signed by the Parties. Any waiver hereunder shall not be valid unless in writing and signed by the Party against whom waiver is asserted. Notwithstanding the foregoing, administrative changes mutually agreed by Company and Seller in writing, such as changes to settings shown in the **Attachment E** (Single-Line Drawing and Interface Block Diagram) and **Attachment F** (Relay List and Trip Scheme) and changes to numerical values of Performance Standards in **Section 3** (Performance Standards) of **Attachment B** (Facility Owned by Seller) shall not be considered amendments to this Agreement requiring PUC approval.

### **27.2. Binding Effect.**

This Agreement shall be binding upon and inure to the benefit of the Parties hereto and their respective successors, legal representatives, and permitted assigns.

### **27.3. Notices.**

(a) All notices, consents and waivers under this Agreement shall be in writing and will be deemed to have been duly given when (i) delivered by hand, (ii) sent by E-Mail, (iii) sent by certified mail, return receipt requested, or (iv) when received by the addressee, if sent by a nationally recognized overnight delivery service (receipt requested), in each case to the appropriate addresses and E-mail addresses set forth below (or to such other addresses and facsimile numbers as a Party may designate by notice to the other Party):

**Company:**

By Mail, Delivered by Hand or Overnight Delivery:

Hawai'i Electric Light Company, Inc.  
54 Halekauila Street  
Hilo, Hawai'i 96720  
Attn: System Operations and Planning

By E-Mail:

Hawai'i Electric Light Company, Inc.  
System Operations and Planning  
Email: PPANotices@hawaiielectriclight.com

With a copy to:

By Mail:

Hawaiian Electric Company, Inc.  
Legal Division  
P.O. Box 2750  
Honolulu, Hawai'i 96840

By E-Mail:

Hawaiian Electric Company, Inc.  
Legal Division  
Email: legalnotices@hawaiianelectric.com

**Seller:** The contact information listed in **Attachment A** (Description of Storage Facility).

**(b)** Notice sent by mail shall be deemed to have been given on the date of actual delivery or at the expiration of the fifth (5<sup>th</sup>) Day after the date of mailing, whichever is earlier. Any Party hereto may change its address for written notice by giving written notice of such change to the other Party hereto.

**(c)** Any notice delivered by E-Mail shall request a receipt thereof confirmed by E-Mail or in writing by the recipient and followed by personal or mail delivery of such correspondence and attachments as may be requested by the recipient, and the effective date of such notice shall be the date of receipt, provided such receipt has been confirmed by the recipient.

**(d)** The Parties may agree in writing upon additional means of providing notices, consents and waivers under this Agreement in order to adapt to changing technology and commercial practices.

#### **27.4. Entire Agreement.**

This Agreement, the GHG Letter Agreement and the IRS Letter Agreement (together with any confidentiality or non-disclosure agreements entered into by the Parties during the process of negotiating this Agreement and/or discussing the specifications of the Facility) constitutes the entire agreement between the Parties relating to the subject matter hereof, superseding all prior agreements, understandings or undertakings, oral or written. Each of the Parties confirms that in entering into this Agreement, it has not relied on any statement, warranty or other representations (other than those set out in this Agreement) made or information supplied by or on behalf of the other Party.

#### **27.5. Effect of Section and Attachment Headings.**

The table of contents and paragraph headings of the various sections and attachments have been inserted in this Agreement as a matter of convenience for reference only and

shall not modify, define or limit any of the terms or provisions hereof and shall not be used in the interpretation of any term or provision of this Agreement.

**27.6. Non-Waiver.**

Except as otherwise provided in this Agreement, no delay or forbearance of Company or Seller in the exercise of any remedy or right will constitute a waiver thereof, and the exercise or partial exercise of a remedy or right shall not preclude further exercise of the same or any other remedy or right.

**27.7. Relationship of the Parties.**

Nothing in this Agreement shall be deemed to constitute either Party hereto as partner, agent or representative of the other Party or to create any fiduciary relationship between the Parties. Seller does not hereby dedicate any part of Facility to serve Company, Company's customers or the public.

**27.8. Governing Law, Jurisdiction and Venue.**

Interpretation and performance of this Agreement shall be in accordance with, and shall be controlled by, the laws of the State of Hawai'i, other than the laws thereof that would require reference to the laws of any other jurisdiction. By entering into this Agreement, Seller submits itself to the personal jurisdiction of the courts of the State of Hawai'i and agrees that the proper venue for any civil action arising out of or relating to this Agreement shall be Honolulu, Hawai'i.

**27.9. Limitations.**

Nothing in this Agreement shall limit Company's ability to exercise its rights as specified in Company tariffs as filed with the PUC, or as specified in General Order No. 7 of the PUC's Standards for Electric Utility Service in the State of Hawai'i, as either may be amended from time to time.

**27.10. Further Assurances.**

If either Party determines in its reasonable discretion that any further instruments, assurances or other things are necessary or desirable to carry out the terms of this Agreement, the other Party will execute and deliver all such instruments and assurances and do all things reasonably necessary or desirable to carry out the terms of this Agreement.

**27.11. Electronic Signatures and Counterparts.**

This Agreement and any subsequent writings, including amendments, may be executed and delivered by exchange of executed copies via E-mail or other acceptable electronic means, and in electronic formats such as Adobe PDF or other formats mutually agreeable between the parties which preserve the final terms of this Agreement or such writing. A party's signature transmitted by facsimile, E-mail, or other acceptable electronic means shall be considered an "original" signature which is

binding and effective for all purposes of this Agreement. This Agreement may be executed in counterparts, each of which shall be deemed an original, and all of which shall together constitute one and the same instrument binding all Parties notwithstanding that all of the Parties are not signatories to the same counterparts. For all purposes, duplicate unexecuted and unacknowledged pages of the counterparts may be discarded and the remaining pages assembled as one document.

### **27.12. Severability.**

If any term or provision of this Agreement, or the application thereof to any person, entity or circumstances is to any extent invalid or unenforceable, the remainder of this Agreement, or the application of such term or provision to persons, entities or circumstances other than those as to which it is invalid or unenforceable, shall not be affected thereby, and each term and provision of this Agreement shall be valid and enforceable to the fullest extent permitted by law, and the Parties will take all commercially reasonable steps, including modification of the Agreement, to preserve the economic “benefit of the bargain” to both Parties notwithstanding any such aforesaid invalidity or unenforceability.

### **27.13. Settlement of Disputes.**

Except as otherwise expressly provided, any dispute or difference arising out of this Agreement or concerning the performance or the non-performance by either Party of its obligations under this Agreement shall be determined in accordance with the dispute resolution procedures set forth in **Article 26** (Dispute Resolution) of this Agreement.

### **27.14. Proprietary Rights.**

Seller agrees that in fulfilling its responsibilities under this Agreement, it will not use any process, program, design, device or material that infringes on any United States patent, trademark, copyright or trade secret (“**Proprietary Rights**”). Seller agrees to indemnify, defend and hold harmless the Indemnified Company Party from and against all losses, damages, claims, fees and costs, including but not limited to reasonable attorneys’ fees and costs, arising from or incidental to any suit or proceeding brought against the Indemnified Company Party for infringement of third-party Proprietary Rights arising out of Seller’s performance under this Agreement, including but not limited to patent infringement due to the use of technical features of the Facility to meet the Performance Standards specified in the Agreement.

### **27.15. Negotiated Terms.**

The Parties agree that the terms and conditions of this Agreement are the result of negotiations between the Parties and that this Agreement shall not be construed in favor of or against any Party by reason of the extent to which any Party or its professional advisors participated in the preparation of this Agreement.

## **27.16. Computation of Time.**

In computing any period of time prescribed or allowed under this Agreement, the Day of the act, event or default from which the designated period of time begins to run shall not be included. If the last Day of the period so computed is not a Business Day, then the period shall run until the end of the next Day which is a Business Day.

## **27.17. Community Outreach Plan.**

(a) The Parties acknowledge and agree that Company will manage community outreach and engagement efforts for the Company's overall Microgrid project, including informing neighboring communities and stakeholders to gain their support for the same. Notwithstanding the foregoing, Seller shall fully cooperate and assist Company with such community outreach efforts. This includes participating in all public meetings at which the Company requests Seller's attendance (e.g., large community meetings, roundtable discussions, one-on-one meetings, etc.), , and otherwise supporting Company's community outreach and engagement efforts, as reasonably requested by Company. listening to community concerns and thoughtfully considering any actions or solutions to mitigate issues as needed Seller shall also promptly respond to and address any community or stakeholder questions/concerns related to the Facility.

(b) Seller shall also fully cooperate and assist Company with Company's cultural resource outreach efforts. This includes complying with any requirements established by Company or its cultural resource impact plan to take into account the Microgrid's, or the Facility's, potential impacts on any historical and cultural resources in the area in question. Seller shall be responsible for obtaining any necessary permits required by Company consistent with its cultural resource impact plan, as instructed by the Company.

(c) For the Term of this Agreement, Seller agrees to maintain a publicly available website with links to Company's Microgrid project website, for purposes of providing neighboring communities and stakeholders access to timely information during all phases of the Project. Seller's website shall also include up-to-date information regarding the Facility itself, consistent with the requirements of the RFP, including, but not limited to, Facility description, Facility stakeholders, community concerns regarding the Facility and Seller's efforts to address such concerns, Facility benefits, government approvals, Facility schedule, and an environmental compliance and permitting plan.

(d) Seller acknowledges and agrees that, subsequent to the PUC Submittal Date and prior to the date when the Parties' statements of position are to be filed in the docketed PUC proceeding for this Project: (i) Seller shall provide Company copies of any and all public comments it receives (in its original, unedited form) related to the Facility or the Company's Microgrid project, and (ii) any and all public comments received by Company and/or Seller related to the Facility or the Company's Microgrid project will be included (in its original, unedited form) in Company's submission to the PUC of its application for a satisfactory PUC Approval Order.

(e) Upon the Execution Date and at all times during the Term of this Agreement, Seller shall designate an individual as the “Seller’s Community Representative.” The Seller’s Community Representative shall be the primary contact between the community and the Seller and shall be available during the Term of this Agreement to receive and answer questions from the community. As of the Execution Date the Seller’s Community Representative shall be:

Name: [name of Seller’s Community Representative]

Contact Information: [email address]

Seller shall notify Company in writing upon designation of any new Seller’s Community Representative.

### **27.18. Change in Standard System or Organization.**

(a) **Consistent with Original Intent.** If, during the Term, any standard, system or organization referenced in this Agreement should be modified or replaced in the normal course of events, such modification or replacement shall from that point in time be used in this Agreement in place of the original standard, system or organization, but only to the extent such modification or replacement is generally consistent with the original spirit and intent of this Agreement.

(b) **Eliminated or Inconsistent with Original Intent.** If, during the Term, any standard system or organization referenced in this Agreement should be eliminated or cease to exist, or is modified or replaced and such modification or replacement is inconsistent with the original spirit and intent of this Agreement, then in such event the Parties will negotiate in good faith to amend this Agreement to a standard, system or organization that would be consistent with the original spirit and intent of this Agreement.

### **27.19. No Third-Party Beneficiaries.**

Nothing expressed or referred to in this Agreement will be construed to give any person or entity other than the Parties any legal or equitable right, remedy, or claim under or with respect to this Agreement or any provision of this Agreement. This Agreement and all of its provisions and conditions are for the sole and exclusive benefit of the Parties and their successors and permitted assigns.

### **27.20. Hawai‘i General Excise Tax.**

Seller shall, when making payments to Company under this Agreement, pay such additional amount as may be necessary to reimburse Company for the Hawai‘i general excise tax on gross income and all other similar taxes imposed on Company by any Governmental Authority with respect to payments in the nature of gross receipts tax, sales tax, privilege tax or the like (including receipt of any payment made under this **Section 27.20** (Hawai‘i General Excise Tax)), but excluding federal or state net income taxes. By way of example and not limitation, as of the Execution Date, all payments subject to the Hawai‘i general excise tax plus surcharge on Hawai‘i Island (totaling 4.5% as of the Execution Date) would include an additional 4.7120% so that the



underlying payment will be net of such tax liability. Company will not reimburse Seller for any taxes or fees imposed on Seller including, but not limited to, State of Hawai'i general excise tax.

### **27.21. Specifications; No Endorsement.**

Wherever in this Agreement Company has the right to give specifications, determinations or approvals, such specifications, determinations or approvals shall be given in accordance with Company's standard practices, policies and procedures and shall not be unreasonably withheld. Any such specifications, determinations, or approvals shall not be deemed to be an endorsement, warranty, or waiver of any right of Company.

### **27.22. Survival of Obligations.**

The rights and obligations that are intended to survive a termination of this Agreement are all of those rights and obligations that this Agreement expressly provides shall survive any such termination and those that arise from Seller's or Company's covenants, agreements, representations, and warranties applicable to, or to be performed, at or during any time prior to or as a result of the termination of this Agreement, including, without limitation:

- (a) The obligation to pay Daily Delay Damages under **Section 11.6** (Damages and Termination);
- (b) The obligation to pay Termination Damages under **Article 6** (Events of Default; Remedies; Termination);
- (c) The indemnity obligations under **Article 20** (Indemnification) and **Section 27.14** (Proprietary Rights);
- (d) The dispute resolution provisions of **Article 26** (Dispute Resolution);
- (e) **Article 19** (Limitations), **Section 27.3** (Notices), **Section 27.6** (Non-Waiver), **Section 27.8** (Governing Law, Jurisdiction and Venue), **Section 27.9** (Limitations), **Section 27.12** (Severability), **Section 27.13** (Settlement of Disputes), **Section 27.14** (Proprietary Rights), **Section 27.16** (Computation of Time), **Section 27.19** (No Third-Party Beneficiaries), **Section 27.20** (Hawai'i General Excise Tax), this **Section 27.22** (Survival of Obligations), **Section 7** (Land Restoration) of **Attachment G** (Company-Owned Interconnection Facilities) and **Section 1(d)** (Seller's Right to Transfer) and **Section 2(d)** (Right of First Refusal) of **Attachment P** (Sale of Facility by Seller); and Seller's obligations to pay operation and maintenance costs incurred up to the date of termination of the Agreement under **Section 4** (Ongoing Operation and Maintenance Charges) of **Attachment G** (Company-Owned Interconnection Facilities).

### **27.23. Certain Rules of Construction.**

For purposes of this Agreement:

- (a) "Including" and any other words or phrases of inclusion will not be

construed as terms of limitation, so that references to “included” matters will be regarded as non-exclusive, non-characterizing illustrations;

(b) “Copy” or “copies” means that the copy or copies of the material to which it relates are true, correct and complete;

(c) When “Article,” “Section,” “Schedule,” or “Attachment” is capitalized in this Agreement, it refers to an article, section, schedule or attachment to this Agreement;

(d) “Will” has the same meaning as “shall” and, thus, connotes an obligation and an imperative and not a futurity;

(e) Titles and captions of or in this Agreement, the cover sheet and table of contents of this Agreement, and language in parenthesis following Section references are inserted only as a matter of convenience and in no way define, limit, extend or describe the scope of this Agreement or the intent of any of its provisions;

(f) Whenever the context requires, the singular includes the plural and plural includes the singular, and the gender of any pronoun includes the other genders; and

(g) Any reference to any statutory provision includes each successor provision and all applicable Laws as to that provision.

## **27.24. Agreement is Not a Design or Construction Contract.**

The Parties acknowledge and agree that Seller will finance and develop the Facility for Seller to own and operate. Seller is not a design professional or a contractor. Seller is not hereby undertaking to perform and is not holding itself out or offering to perform any work for which a professional or contractor's license may be required under the laws of the State of Hawai'i. Notwithstanding anything to the contrary, all work related to the design, engineering, and construction of the Facility shall be performed by design professionals and contractors who hold the appropriate licenses issued by the State of Hawai'i and intend to develop the Facility in full compliance with all applicable state laws. For the avoidance of doubt, in all instances where this Agreement refers to Seller performing the acts of constructing, building or installing, said language shall be interpreted to mean that such work will be performed by duly licensed contractors properly retained by Seller in accordance with laws of the State of Hawai'i.

**[Signatures for Energy Storage Services Agreement  
appear on the following page]**



IN WITNESS WHEREOF, the Parties have caused this Agreement to be executed by their duly authorized representatives.

**HAWAI'I ELECTRIC LIGHT COMPANY, INC.**, a  
Hawai'i corporation

By: \_\_\_\_\_

Name:

Title:

By: \_\_\_\_\_

Name:

Title:

(“Company”)

**[SELLER NAME]**, a **[Seller's business registration]**

By: \_\_\_\_\_

Name:

Title:

By: \_\_\_\_\_

Name:

Title:

(“Seller”)

## **SCHEDULE OF DEFINED TERMS**

“**Acceptance Notice**” has the meaning set forth in **Section 1(a)(ii)** of **Attachment P** (Sale of Facility by Seller) to this Agreement.

“**Acceptance Test**” means a test conducted by Seller and witnessed by Company, within thirty (30) Days of completion of all Interconnection Facilities and in accordance with criteria and test procedures determined by Company and Seller as set forth in **Section 3** (Acceptance Test Procedures) of **Attachment G** (Company-Owned Interconnection Facilities), to determine conformance with **Attachment B** (Facility Owned by Seller), **Attachment G** (Company-Owned Interconnection Facilities) and Good Engineering and Operating Practices. **Attachment N** (Acceptance Test General Criteria) provides general criteria to be included in the written protocol for the Acceptance Test. Successful completion of the Acceptance Test shall be a condition precedent for the performance of the Control System Acceptance Test and the Commercial Operations Date.

“**Active Power Control Interface**” has the meaning set forth in **Section 1(g)** (Active Power Control Interface) of **Attachment B** (Facility Owned by Seller) of this Agreement.

“**Agreement**” has the meaning set forth in the preamble.

“**Appeal Period**” has the meaning set forth in **Section 24.5(b)** (Non-Appealable PUC Approval Order).

“**Appraised Fair Market Value of the Facility**” has the meaning set forth in **Section 3(d)** of **Attachment P** (Sale of Facility by Seller) to this Agreement.

“**Back-up Power**” means the capability described in **Section 3(w)** (Back-up Power) of **Attachment B** (Facility Owned by Seller).

“**Bill of Material**” means a list of equipment to be installed at the Facility including, but not necessarily limited to, items such as relays, breakers, and switches.

“**Black-Start**” means the capability described in **Section 3(r)** (Black-Start Capability) of **Attachment B** (Facility Owned by Seller).

“**Business Day**” means any Day except a Saturday, a Sunday, or a federal or Hawai'i state holiday.

“**Capacity Ratio**” has the meaning set forth in **Attachment T** (Capacity Ratio and RTE Ratio) to this Agreement.

“**Capacity Test**” has the meaning set forth in **Attachment T** (Capacity Ratio and RTE Ratio) to this Agreement.

“**Charging Energy**” means the amount of Energy withdrawn from the Company System to be stored by the Facility and discharged at a later time, as measured in MWh by the Revenue Metering Package. .

“**Change in Control**” has the meaning set forth in **Section 1(b)** (Change in Ownership Interests and Control of Seller) of **Attachment P** (Sale of Facility by Seller) to this Agreement.

“**Claim**” means any claim, suit, action, demand or proceeding.

“**COD Delay LD Period**” has the meaning set forth in **Section 11.6(a)(ii)**.

“**Commercial Operations**,” with respect to the Facility, shall be considered achieved upon satisfaction of the following conditions:

- (a) the Acceptance Test has been passed;
- (b) all Storage Unit(s) have passed Control System Acceptance Tests;
- (c) Seller has (i) provided to Company the Required Models (as defined in **Section 6(a)** (Seller's Obligation to Provide Models) of **Attachment B** (Facility Owned by Seller)) in the form of Source Code; (ii) placed the current version of the Source Code for the Required Models with the Source Code Escrow Agent as required in **Section 6(b)(i)(A)** (Establishment of Source Code Escrow) of **Attachment B** (Facility Owned by Seller); or (iii) if Seller is unable to arrange for the placement of the appropriate Source Code into the Source Code Escrow account, placed the required funds with the Proceeds Escrow Agent as required in **Section 6(b)(ii)(A)** (Establishment of Monetary Escrow) of **Attachment B** (Facility Owned by Seller); and
- (d) Seller has provided Company with written notice that Seller is ready to declare the Commercial Operations Date, which shall be the Day following the Day Company receives such written notice from Seller.

“**Commercial Operations Date**” or “**COD**” means the date on which the Facility first achieves Commercial Operations.

“**Company**” has the meaning set forth in the preamble of this Agreement.

“**Company-Owned Interconnection Facilities**” has the meaning set forth in **Section 1** (General) of **Attachment G** (Company-Owned Interconnection Facilities).

“**Company Dispatch/Charge**” has the meaning set forth in **Section 12.1(a)** (Company’s Exclusive Rights).

“**Company Milestones**” means each of the milestones identified as such in **Attachment K-1** (Seller's Conditions Precedent and Company Milestones).

“**Company Milestone Date**” has the meaning set forth in **Section 11.5** (Company Milestones).

“**Company System**” means the electric system owned and operated by Company (to include any non-utility owned facilities) consisting of power plants, transmission and distribution lines, and related equipment for the production and delivery of electric power to the public.

**“Company System Operator”** means the authorized representative(s) of Company who is/are responsible for carrying out Company Dispatch/Charge with respect to the Facility.

**“Company’s Recommendations”** has the meaning set forth in **Section 4(c)** of **Attachment B** (Facility Owned by Seller).

**“Competitive Bidding Framework”** means The Framework for Competitive Bidding contained in Decision and Order No. 23121 issued by the Public Utilities Commission on December 8, 2006, and any subsequent orders providing for modifications from those set forth in Order No. 23121 issued December 8, 2006.

**“Construction Delay LD Period”** has the meaning set forth in **Section 11.6(a)(i)**.

**“Construction Milestones”** means the Guaranteed Project Milestones and the Reporting Milestones set forth in **Attachment K** (Guaranteed Project Milestones) **Attachment L** (Reporting Milestones) of this Agreement, respectively.

**“Consultants List”** has the meaning set forth in **Section 4(e)** of **Attachment B** (Facility Owned by Seller).

**“Contract Capacity”** has the meaning set forth in **Section 8(c)** of **Attachment A** (Description of Storage Facility).

**“Contract Year”** means the twelve (12) calendar month period commencing on either (a) the Commercial Operations Date (if the Commercial Operations Date occurs on the first (1<sup>st</sup>) Day of a calendar month); or (b) the first Day of the calendar month following the month during which the Commercial Operations Date occurs, and thereafter on each anniversary of the first Day of such month; provided, however, that, in the latter case, the initial Contract Year shall also include the Days from the Commercial Operations Date to the first (1<sup>st</sup>) Day of succeeding calendar month.

**“Control System Acceptance Test”** or **“CSAT”** means a test or tests performed on the centralized and collective control systems and Active Power Control Interface of the Facility, which includes successful completion of the Control System Telemetry and Control List, in accordance with procedures set forth in **Section 1(h)** (Control System Acceptance Test Procedures) of **Attachment B** (Facility Owned by Seller). **Attachment O** (Control System Acceptance Test Criteria) provides general criteria to be included in the written protocol for the Control System Acceptance Test.

**“Control System Telemetry and Control List”** includes, but is not limited to, all of the Facility's equipment and generation performance/quality parameters that will be monitored, alarmed and/or controlled by the Company throughout the Term of this Agreement. Examples of the Control System Telemetry and Control List include:

- (a) Seller's substation/equipment status – breaker open/closed status, equipment normal/alarm operating status, etc.
- (b) Active Power control interface – dispatch MW setpoint, etc.
- (c) Voltage control interface – voltage kV setpoint, etc.

- (d) Microgrid transition control points and feedback signals
- (e) Control of frequency response modes

“**Daily Delay Damages**” has the meaning set forth in **Section 11.6(a)(i)**.

“**Day**” means a calendar day.

“**Defaulting Party**” means the Party whose failure, action or breach of its obligations under this Agreement results in an Event of Default under **Article 6** (Events of Default; Remedies; Termination).

“**Development Period Security**” has the meaning set forth in **Section 14.1(a)** (General).

“**Discharge Energy**” means all Energy discharged from the Facility as measured in MWh by the Revenue Metering Package.

“**Disconnection Event**” has the meaning set forth in **Section 4(a)** of **Attachment B** (Facility Owned by Seller).

“**Dispute**” means any and all disputes, claims or controversies arising out of, relating to, concerning or pertaining to the terms of this Agreement, or to either Party’s performance or failure of performance under this Agreement.

“**DPR**” has the meaning set forth in **Section 26.2** (Dispute Resolution Procedure).

“**E-Mail**” means electronic mail.

“**Effective Date**” means the last to occur of (a) the Non-Appealable PUC Approval Order Date; and (b) the date that the Interconnection Requirements Amendment (if required pursuant to **Section 2.3(a)** of this Agreement) is executed and delivered as such date is set forth in the Interconnection Requirements Amendment.

“**Energy**” means alternating current electrical energy measured in kilowatthours (kWh).

“**Energy Cost Recovery Clause**” means the provision in Company’s rate schedules that allows Company to pass through to its customers Company’s costs of fuel and purchased power.

“**Energy Management System**” or “**EMS**” means the real-time, computer-based control system, or any successor thereto, used by Company to manage the supply and delivery of electric energy to its consumers. It provides the Company System Operator with an integrated set of manual and automatic functions necessary for the operation of the Company System under both normal and emergency conditions. The EMS provides the interfaces for the Company System Operator to perform real-time monitoring and control of the Company System, including but not limited to monitoring and control of the Facility for grid connected operation and transitioning to islanding microgrid operation.

“**Energy Storage Services**” means, collectively or individually, all services the Facility

is capable of providing (the technical and operational requirements of which may be further described in **Attachment B** (Facility Owned by Seller), including, without limitation, the acceptance of Charging Energy at the Point of Interconnection from the Company System, the storing of Energy in the Facility, the delivery of Discharge Energy to the Point of Interconnection from the Facility, Back-up Power, Frequency Regulation, Voltage Regulation, Black-start, ability to operate in grid-forming mode, and uses of the Facility for the benefit of Company's distribution or transmission system..

**"Environment"** has the meaning set forth in **Section 1(b)(iii)(G)(3)** (Endpoint and Server Security) of **Attachment B** (Facility Owned by Seller).

**"EPC Contract"** means Seller's engineering, procurement and construction contract with the EPC Contractor.

**"EPC Contractor"** means Seller's engineering, procurement and construction contractor for the Facility.

**"ESSA Amendment Deadline"** means the sixtieth (60<sup>th</sup>) Day following the date the completed IRS is provided to Seller, or such later date as Company and Seller may agree to by written agreement.

**"Escrow Agent"** has the meaning set forth in **Section 14.7** (L/C Proceeds Escrow).

**"Event of Default"** has the meaning set forth in **Article 6** (Events of Default; Remedies; Termination).

**"Exclusive Negotiation Period"** has the meaning set forth in **Section 2(b)** (Negotiations) of **Attachment P** (Sale of Facility by Seller) to this Agreement.

**"Execution Date"** has the meaning set forth in the preamble of this Agreement.

**"Exempt Sales"** has the meaning set forth in **Section 1(c)** (Exempt Sales) of **Attachment P** (Sale of Facility by Seller) to this Agreement.

**"Extended Term"** has the meaning set forth in **Section 3.1** (Term).

**"Facility"** means the battery energy storage system that is the subject of this Agreement, together with all Storage Units, Seller-Owned Interconnection Facilities, and all other equipment, devices, associated appurtenances owned, controlled, operated and managed by Seller for integration with a Microgrid in connection with, and to facilitate the storing of electric energy at the Facility and the charging of electric energy from, and the discharging of electric energy to, the Company System, as described in **Attachment A** (Description of Storage Facility) and **Attachment B** (Facility Owned by Seller).

**"Facility Debt"** means the obligations of Seller to any lender pursuant to the Financing Documents, including without limitation, principal of, premium and interest on indebtedness, fees, expenses or penalties, amounts due upon acceleration, prepayment or restructuring, swap or interest rate hedging breakage costs and any claims or interest due with respect to any of the foregoing.

**“Facility Lender”** means any lender(s) or tax equity financing party providing any Facility Debt and any successor(s) or assigns thereto, collectively.

**“FASB”** has the meaning set forth in **Section 23.1** (Financial Compliance).

**“FASB ASC 810”** has the meaning set forth in **Section 23.1** (Financial Compliance).

**“FASB ASC 842”** has the meaning set forth in **Section 23.1** (Financial Compliance).

**“Final Non-Appealable Order from the PUC”** has the meaning set forth in **Section 5(d)** of **Attachment P** (Sale of Facility by Seller) to this Agreement.

**“Financial Compliance Information”** has the meaning set forth in **Section 23.1** (Financial Compliance).

**“Financial Termination Costs”** has the meaning set forth in **Section 6** (Make Whole Amount) of **Attachment P** (Sale of Facility by Seller).

**“Financing Documents”** means the loan and credit agreements, notes, bonds, indentures, security agreements, lease financing agreements, mortgages, deeds of trust, interest rate exchanges, swap agreements and other documents relating to the development, bridge, construction and/or permanent debt financing for the Facility, including any credit enhancement, credit support, working capital financing, tax equity financing or refinancing documents, and any and all amendments, modifications, or supplements to the foregoing that may be entered into from time to time at the discretion of Seller in connection with development, construction, ownership, leasing, operation or maintenance of the Facility.

**“Force Majeure”** means an event that satisfies the requirements of **Section 17.1** (Definition of Force Majeure), **Section 17.2** (Events That Could Qualify as Force Majeure) and **Section 17.3** (Exclusions From Force Majeure).

**“Force Majeure Notice”** has the meaning set forth in **Section 17.4** (Satisfaction of Certain Conditions).

**“Forced Outage”** means a start failure or unplanned outage reported consistently with the principles in the NERC GADS REPORTING INSTRUCTIONS for SF, U1, U2 and U3 events.

**“Frequency Regulation”** means the capability to control active power, for the purpose of retaining a target frequency under changing load and generation conditions.

**“GAAP”** has the meaning set forth in **Section 23.5(a)** (Consolidation).

**“GHG Letter Agreement”** means the letter agreement and any written, signed amendments thereto, between Company and Seller that describes the scope, schedule, and payment arrangements for the greenhouse gas emissions analysis required under **Section 24.1** (General).

**“Good Engineering and Operating Practices”** means the practices, methods and acts engaged in or approved by a significant portion of the electric utility industry for

similarly situated U.S. facilities, considering Company's isolated island setting, that at a particular time, in the exercise of reasonable judgment in light of the facts known or that reasonably should be known at the time a decision is made, would be expected to accomplish the desired result in a manner consistent with Law, regulation, reliability for an island system, safety, environmental protection, economy and expedition. With respect to the Facility, Good Engineering and Operating Practices include, but are not limited to, taking reasonable steps to ensure that:

(a) Adequate materials, resources and supplies, including fuel and spare parts inventories, are available to meet the Facility's needs under normal conditions and reasonably foreseeable abnormal conditions.

(b) Sufficient operating personnel are available and are adequately experienced and trained to operate the Facility properly, efficiently and within manufacturer's guidelines and specifications and are capable of responding to emergency conditions.

(c) Preventive, routine and non-routine maintenance and repairs are performed on a basis that ensures reliable long-term and safe operation, and are performed by knowledgeable, trained and experienced personnel utilizing proper equipment, tools, and procedures.

(d) Appropriate monitoring and testing is done to ensure equipment is functioning as designed and to provide assurance that equipment will function properly under both normal and reasonably foreseeable abnormal conditions.

(e) Equipment is operated in a manner safe to workers, the general public and the environment and in accordance with equipment manufacturer's specifications, including, without limitation, defined limitations such as steam pressure, temperature, moisture content, chemical content, quality of make-up water, operating voltage, current, frequency, rotational speed, polarity, synchronization, control system limits, etc.

(f) Equipment and components are designed and manufactured to meet or exceed the standard of durability that is generally used for similarly situated battery energy storage systems/facilities, considering Company's isolated island setting, and will function properly over the full range of ambient temperature and weather conditions reasonably expected to occur at the Site and under both normal and emergency conditions.

**“Governmental Approvals”** means all permits, licenses, approvals, certificates, entitlements and other authorizations issued by Governmental Authorities, as well as any agreements with Governmental Authorities, required for the construction, ownership, operation and maintenance of the Facility and the Company-Owned Interconnection Facilities, and all amendments, modifications, supplements, general conditions and addenda thereto.

**“Governmental Authority”** means any federal, state, local or municipal governmental body; any governmental, quasi-governmental, regulatory or administrative agency, commission, body or other authority exercising or entitled to exercise any



administrative, executive, judicial, legislative, policy, regulatory or taxing authority or power; or any court or governmental tribunal.

**“Guaranteed Commercial Operations Date”** is the date specified as such in **Attachment K** (Guaranteed Project Milestones) of this Agreement, by which Seller guarantees it will achieve the Commercial Operations Date.

**“Guaranteed Project Milestone”** means each of the milestone events identified in **Attachment K** (Guaranteed Project Milestones) of this Agreement.

**“Guaranteed Project Milestone Date”** means each of the milestone dates identified in **Attachment K** (Guaranteed Project Milestones) of this Agreement.

**“HEI”** means Hawaiian Electric Industries, Inc.

**“HERA”** means the Hawai‘i Electricity Reliability Administrator.

**“HERA Law”** means Act 166 (Haw. Leg. 2012), which was passed by the 27th Hawai‘i Legislature in the form of S.B. No. 2787, S.D. 2, H.D.2, C.D.1 on May 2, 2012 and signed by the Governor on June 27, 2012. The effective date for the law is July 1, 2012. The HERA Law authorizes (a) the PUC to develop, adopt, and enforce reliability standards and interconnection requirements; (b) the PUC to contract for the performance of related duties with a party that will serve as the HERA; and (c) the collection of a Hawai‘i electricity reliability surcharge to be collected by Hawai‘i’s electric utilities and used by the HERA. Reliability standards and interconnection requirements adopted by the PUC pursuant to the HERA Law will apply to any electric utility and any user, owner, or operator of the Hawai‘i electric system. The PUC also is provided with the authority to monitor and compel the production of data, files, maps, reports, or any other information concerning any electric utility, any user, owner or operator of the Hawai‘i electric system, or other person, business, or entity, considered by the commission to be necessary for exercising jurisdiction over interconnection to the Hawai‘i electric system, or for administering the process for interconnection to the Hawai‘i electric system.

**“Indemnified Company Party”** has the meaning set forth in **Section 20.1(a)** (Third-Party Claims).

**“Indemnified Seller Party”** has the meaning set forth in **Section 20.2(a)** (Third-Party Claims).

**“Independent Evaluator”** means a person empowered, pursuant to **Section 22.5** (Failure to Reach Agreement), **Section 22.10** (Dispute) and **Section 2(c)** (Appointment of Independent Evaluator) of **Attachment S** (Monthly Reporting and Dispute Resolution by Independent Evaluator) to this Agreement, to resolve (a) disputes due to failure of the Parties to agree on a Performance Standards Revision Document; and (b) disagreements due to failure of the Parties to resolve a Monthly Report Disagreement.

**“Initial Term”** has the meaning set forth in **Section 3.1** (Term).

**“Interconnection Facilities”** means all the equipment and devices required to permit

the Facility to operate in parallel with the Company System; make available to Company the Energy Storage Services; and provide reliable and safe operation of, and power quality on, the Company System (in accordance with applicable provisions of the PUC's General Order No. 7, Company tariffs, operational practices, interconnection requirements studies, and planning criteria), such as, but not limited to, transmission and distribution lines, transformers, switches, and circuit breakers.

**"Interconnection Requirements Amendment"** has the meaning set forth in **Section 2.3** of this Agreement.

**"Interconnection Requirements Study"** or **"IRS"** means a study, performed in accordance with the terms of the IRS Letter Agreement to determine, among other things, (a) the system requirements and equipment requirements to interconnect the Facility with the Company System; (b) the Performance Standards for the Facility; and (c) an estimate of costs and schedule for interconnection of the Facility.

**"Interface Block Diagram"** means the visual representation of the signals between Seller and Company, including but not limited to Telemetry and Control points, digital fault recorder settings, telecommunications and protection signals.

**"IRS Letter Agreement"** means the system impact study and Facility study letter agreement and any written, signed amendments thereto, between Company and Seller that describe the scope, schedule and payment arrangements for the IRS.

**"L/C Proceeds"** has the meaning set forth in **Section 14.6** (Failure to Renew or Extend Letter of Credit).

**"Land"** means, for purposes of **Section 7** (Land Restoration) of **Attachment G** (Company-Owned Interconnection Facilities), any portion of the Site and any other real property where any Company-Owned Interconnection Facilities are located.

**"Land Rights"** means all easements, rights of way, licenses, leases, surface use agreements and other interests or rights in real estate.

**"Laws"** means all federal, state and local laws, rules, regulations, orders, ordinances, permit conditions and other governmental actions.

**"LD Assessment Date"** means the Day following the expiration of the 30-Business Day period provided for Company to submit a Notice of Disagreement pursuant to **Section 2(a)** (Notice of Disagreement With Monthly Report) of **Attachment S** (Monthly Reporting and Dispute Resolution by Independent Evaluator) to this Agreement.

**"Losses"** means any and all direct, indirect or consequential damages, fines, penalties, deficiencies, losses, liabilities (including settlements and judgments), costs, expenses (including reasonable attorneys' fees and court costs) and disbursements.

**"Lump Sum Payment"** means the payment to be made by Company to Seller in exchange for Seller making the Energy Storage Services of the Facility available for Company Dispatch/Charge, or \$[ ] per year, based on the pricing Seller submitted in its RFP Proposal.

**“Make Whole Amount”** has the meaning set forth in **Section 6** (Make Whole Amount) of **Attachment P** (Sale of Facility by Seller).

**“Malware”** means computer software, code or instructions that: (a) intentionally, and with malice intent by a third party, adversely affect the operation, security or integrity of a computing, telecommunications or other digital operating or processing system or environment, including without limitation, other programs, data, databases, computer libraries and computer and communications equipment, by altering, destroying, disrupting or inhibiting such operation, security or integrity; (b) without functional purpose, self-replicate without manual intervention; (c) purport to perform a useful function but which actually performs either a destructive or harmful function, or perform no useful function other than utilize substantial computer, telecommunications or memory resources with the intent of causing harm; or (d) without authorization collect and/or transmit to third parties any information or data; including such software, code or instructions commonly known as viruses, Trojans, logic bombs, worms, adware and spyware.

**“Management Meeting”** has the meaning set forth in **Section 26.1** (Good Faith Negotiations).

**“Microgrid”** has the meaning set forth in the recitals of this Agreement.

**“Monitoring and Communications Equipment”** has the meaning set forth in **Section 9.4** (Monitoring and Communications Equipment).

**“Monthly Progress Report”** has the meaning set forth in **Section 11.2** (Monthly Progress Report).

**“Monthly Report”** means the report of the data (for the calendar month in question and the Measurement Period ending with such calendar month) necessary for the calculation of the Performance Levels to be provided by Seller to Company as set forth in **Section 1** (Monthly Report) of **Attachment S** (Monthly Reporting and Dispute Resolution by Independent Evaluator) to this Agreement.

**“Monthly Report Disagreement”** means any disagreement arising out of the same Monthly Report.

**“NERC GADS”** means the North American Electric Reliability Corporation Generating Availability Data System.

**“Non-Appealable PUC Approval Order”** has the meaning set forth in **Section 24.5(b)** (Non-Appealable PUC Approval Order).

**“Non-Appealable PUC Approval Order Date”** has the meaning set forth in **Section 24.5(d)** (Non-Appealable PUC Approval Order Date).

**“Non-Defaulting Party”** has the meaning set forth in **Section 6.4** (Rights of the Non-Defaulting Party; Forward Contract).

**“Notice of Disagreement”** has the meaning set forth in **Section 2(a)** (Notice of Disagreement With Monthly Report) of **Attachment S** (Monthly Reporting and Dispute

Resolution by Independent Evaluator).

“**Offer Date**” has the meaning set forth in **Section 1(a)(i)** of **Attachment P** (Sale of Facility by Seller) to this Agreement.

“**Offer Materials**” has the meaning set forth in **Section 1(a)(i)** of **Attachment P** (Sale of Facility by Seller) to this Agreement.

“**Offer Notice**” has the meaning set forth in **Section 1(a)(i)** of **Attachment P** (Sale of Facility by Seller) to this Agreement.

“**Offer Price**” has the meaning set forth in **Section 1(a)(i)** of **Attachment P** (Sale of Facility by Seller) to this Agreement.

“**Operating Period Security**” has the meaning set forth in **Section 14.2** (Operating Period Security).

“**Performance Level Availability**” has the meaning set forth in **Section 4.2** (Performance Levels).

“**Performance Level Rated Energy Capacity**” has the meaning set forth in **Section 4.2** (Performance Levels).

“**Performance Level RTE**” has the meaning set forth in **Section 4.2** (Performance Levels).

“**Performance Levels**” means each of the Performance Level Rated Energy Capacity, the Performance Level Availability and the Performance Level RTE.

“**Performance Levels LDs**” has the meaning set forth in **Section 4.6** (Payment of Liquidated Damages for Failure to Achieve Performance Levels; Limitation on Liquidated Damages).

“**Performance Standards**” means the various performance standards specified in **Section 3** (Performance Standards) of **Attachment B** (Facility Owned by Seller) for the operation of the Facility, including the availability of Energy Storage Services to Company, as such standards may be revised from time to time pursuant to **Article 22** (Revisions to Performance Standards) of this Agreement.

“**Performance Standards Information Request**” means a written notice from Company to Seller proposing revisions to one or more of the Performance Standards then in effect and requesting information from Seller concerning such proposed revision(s).

“**Performance Standards Modifications**” means, for each Performance Standards Revision, any capital improvements, additions, enhancements, replacements, repairs or other operational modifications to the Facility and/or to changes in Seller’s operations or maintenance practices necessary to enable the Facility to achieve the performance requirements of such Performance Standards Revision.

“**Performance Standards Pricing Impact**” means any reimbursement, adjustment in

the payment obligations of Company under this Agreement and/or the calculation of Performance Levels LDs, as may be necessary to specifically reflect the recovery of the net costs and/or net lost revenues specifically attributable to any Performance Standards Modification necessary to comply with a Performance Standard Revision, which shall consist of the following: (a) recovery of, and return on, any capital investment (i) made over a cost recovery period starting after the Performance Standards Revision is made effective following a PUC Performance Standards Revision Order through the end of the Term; and (ii) based on a proposed capital structure that is commercially reasonable for such an investment and the return on investment is at market rates for such an investment or similar investment); (b) recovery of reasonably expected net additional operating and maintenance costs; and (c) an adjustment in pricing or Performance Levels, as applicable, necessary to compensate Seller for a reasonably expected reduction, if any, in the Lump Sum Payment, or reasonably expected increases in Performance Levels LDs directly related to the Performance Standards Modification or Performance Standards Revision.

**“Performance Standards Proposal”** means a written communication from Seller to Company detailing the following with respect to a proposed Performance Standards Revision: (a) a statement as to whether Seller believes that it is technically feasible to comply with the Performance Standards Revision and the basis therefor; (b) the Performance Standards Modifications proposed by Seller to comply with the Performance Standards Revision; (c) the capital and incremental operating costs of any necessary technical improvements, and any other incremental net operating or maintenance costs associated with any necessary operational changes, and any expected lost revenues associated with expected reductions in the Energy Storage Services provided to Company; (d) the Performance Standards Pricing Impact of such costs and/or lost revenues; (e) information regarding the effectiveness of such technical improvements or operational modifications; (f) proposed contractual consequences for failure to comply with the Performance Standard Revision that would be commercially reasonable under the circumstances; and (g) such other information as may be reasonably required by Company to evaluate Seller's proposals. A Performance Standards Proposal may be issued either in response to a Performance Standards Information Request or on Seller's own initiative; provided, however, that, in accordance with **Section 22.3** (Performance Standards Proposal), Company shall have no obligation to evaluate a Performance Standards Proposal submitted at Seller's own initiative.

**“Performance Standards Revision”** means a revision, as specified in a Performance Standards Information Request or a Seller-initiated Performance Standards Proposal, to the Performance Standards in effect as of the date of such request or proposal.

**“Performance Standards Revision Document”** means a document specifying one or more Performance Standards Revisions and setting forth the changes to the Agreement necessary to implement such Performance Standards Revision(s). A Performance Standards Revision Document may be either a written agreement executed by Company and Seller or as directed by the Independent Evaluator pursuant to **Section 22.10** (Dispute) of this Agreement, in the absence of such written agreement.

**“Permitted Lien”** has the meaning set forth in **Section 4** (Purchase and Sale Agreement) of **Attachment P** (Sale of Facility by Seller) to this Agreement.

**“Point of Interconnection”** of **“POI”** means the point of delivery of Energy supplied by Seller to Company, where the Facility owned by the Seller interconnects with the Company System. The Seller shall own and maintain the facilities from the Facility to the Point of Interconnection, excluding any Company-Owned Interconnection Facilities located on the Site. The Company shall own and maintain the facilities from the Point of Interconnection to the Company System. The Point of Interconnection will be identified in the IRS and set forth on the Single-Line Drawing and Interface Block Diagram in **Attachment E** (Single-Line Drawing and Interface Block Diagram). The Point of Interconnection will be at the voltage level of the Company System. If it is necessary to step up the voltage at which Energy supplied by Seller is delivered to Company System, the Point of Interconnection will be on the high voltage side of the step-up transformer.

**“Prime Rate”** means the “prime rate” of interest, as published from time to time by The Wall Street Journal in the “Money Rates” section of its Western Edition Newspaper (or the average prime rate if a high and a low prime rate are therein reported). The Prime Rate shall change without notice with each change in the prime rate reported by The Wall Street Journal, as of the date such change is reported. Any such rate is a general reference rate of interest, may not be related to any other rate, may not be the lowest or best rate actually charged by any lender to any customer or a favored rate and may not correspond with future increases or decreases in interest rates charged by lenders or market rates in general.

**“Proceeds”** has the meaning set forth in **Section 6(b)(ii)(C)** (Extend Letter of Credit) of **Attachment B** (Facility Owned by Seller) to this Agreement.

**“Proceeds Escrow Agent”** has the meaning set forth in **Section 6(b)(ii)(D)** (Proceeds Escrow) of **Attachment B** (Facility Owned by Seller) to this Agreement.

**“Proceeds Escrow Agreement”** has the meaning set forth in **Section 6(b)(ii)(D)** (Proceeds Escrow) of **Attachment B** (Facility Owned by Seller) to this Agreement.

**“Project Documents”** means this Agreement any ground lease or other agreement or instrument in respect of the Site and/or the Land Rights, all construction contracts to which Seller is or becomes a party thereto, operation and maintenance agreements, and all other agreements, documents and instruments to which Seller is or becomes a party thereto in respect of the Facility, other than the Financing Documents, as the same may be modified or amended from time to time in accordance with the terms thereof.

**“Proposed Actions”** has the meaning set forth in **Section 4(c)** of **Attachment B** (Facility Owned by Seller) to this Agreement.

**“Proprietary Rights”** has the meaning set forth in **Section 27.14** (Proprietary Rights).

**“PSA”** has the meaning set forth in **Section 4** (Purchase and Sale Agreement) of **Attachment P** (Sale of Facility by Seller) to this Agreement.

**“PUC”** has the meaning set forth in the recitals of this Agreement.

“**PUC Approval Order**” has the meaning set forth in **Section 24.5(a)** (PUC Approval Order).

“**PUC Approval Order Date**” has the meaning set forth in **Section 24.5(c)** (Company’s Written Statement).

“**PUC Approval Time Period**” has the meaning set forth in **Section 24.4** (Time Period for PUC Approval).

“**PUC Order Appeal Period**” has the meaning set forth in **Section 24.4** (Time Period for PUC Approval).

“**PUC Performance Standards Revision Order**” means the decision and order of the PUC approving the application or motion by the Parties seeking (a) approval of the Performance Standards Revision in question and the associated Performance Standards Revision Document; (b) finding that the impact of the changes to Company’s payment obligations under this Agreement on Company’s revenue requirements is reasonable; and (c) approval to include the costs arising out of pricing changes in Company’s Energy Cost Recovery Clause (or equivalent).

“**PUC Submittal Date**” means the date of the submittal of Company’s complete application or motion for a satisfactory PUC Approval Order pursuant to **Section 24.1** (General).

“**PUC’s Standards**” means the Standards for Small Power Production and Cogeneration in the State of Hawai‘i, issued by the Public Utilities Commission of the State of Hawai‘i, Chapter 74 of Title 6, Hawai‘i Administrative Rules, currently in effect and as may be amended from time to time.

“**Qualified Consultant**” has the meaning set forth in **Section 4(e)** of **Attachment B** (Facility Owned by Seller) to this Agreement.

“**Rated Active Power Capacity**” has the meaning set forth in **Section 8(d)** of **Attachment A** (Description of Storage Facility) “**Rated Energy Capacity**” has the meaning set forth in **Section 8(e)** of **Attachment A** (Description of Storage Facility)

“**Recipient**” has the meaning set forth in **Section 23.2** (Confidentiality).

“**Reporting Milestone**” means each of the milestones identified as such in **Attachment L** (Reporting Milestones).

“**Required Model(s)**” has the meaning set forth in **Section 6(a)** (Seller’s Obligation to Provide Models) of **Attachment B** (Facility Owned by Seller).

“**Revenue Metering Package**” means the revenue meter(s), revenue metering PTs and CTs and secondary wiring for the Facility.

“**RFP**” means the Company’s Request for Proposals for Energy Storage, North Kohala, Island of Hawai‘i, issued on [\_\_\_\_\_], 2021.

“**RFP Proposal**” means the documents and submissions comprising Seller’s proposal

selected in the Final Award Group in response to the RFP.

“**Right of First Negotiation Period**” has the meaning set forth in **Section 1(a)(ii)** of **Attachment P** (Sale of Facility by Seller) to this Agreement.

“**Security Funds**” has the meaning set forth in **Section 14.4** (Security Funds).

“**Seller**” has the meaning set forth in the preamble in this Agreement.

“**Seller-Attributable Unavailability**” means the time periods during which the inverter in question (or the Facility as a whole) is not dispatched or is derated or shutdown (or the Facility is disconnected) because of any of the following:

(a) The Facility’s failure to comply with any of the Performance Standards, Good Engineering and Operating Practices, Governmental Approvals, applicable Laws or Seller's other obligations under this Agreement;

(b) Seller-Attributable System Conditions;

(c) Conditions at or on either side of the Point of Interconnection arising from the acts or omissions of Seller or any of its affiliates, employees, agents, contractors, vendors, materialmen, independent contractors or suppliers of Seller, acting in such capacity for the benefit of Seller (“**Seller Representatives**”), unless such acts or omissions are themselves excused by reasons of Force Majeure pursuant to **Article 17** (Force Majeure) of this Agreement;

(d) A disconnection initiated by the Company pursuant to **Article 16** (Personnel and System Safety) of this Agreement) that is caused by Seller or any Seller Representatives;

(e) The Company has reasonably decided that it is inadvisable for such inverter (or the Facility as a whole) to continue normal operations without a further Control System Acceptance Test as provided in **Section 7(a)** (Testing Requirements) of **Attachment B** (Facility Owned by Seller);

(f) The Facility is deemed to be in Seller-Attributable Unavailability status under any of the following sections of **Attachment B** (Facility Owned by Seller): **Section 1(j)** (Demonstration of Facility) or **Section 4(e)**; and

(g) The Facility is shutdown at the direction of Company as provided in **Section 9.6** (Shutdown for Lack of Reliable Real Time Data), and such shutdown is caused by Seller or any Seller Representatives.

Each time period of Seller-Attributable Unavailability shall constitute an Outage or Deration, as applicable.

“**Seller-Attributable System Conditions**” means conditions on the Company System:

(a) that result from either (i) the Facility’s storage and/or delivery of electric power to the Company System; or (ii) any condition arising from the acts or omissions of Seller or any Seller Representative, unless such acts or omissions are themselves



excused by reasons of Force Majeure pursuant to **Article 17** (Force Majeure) of this Agreement; and

(b) caused by or attributable to the Facility or Seller or any Seller Representatives that Company reasonably determines to either (i) be inconsistent with Good Engineering and Operating Practices on the Company System; or (ii) jeopardize the safety, reliability or stability of the Company System.

**“Seller-Owned Interconnection Facilities”** means the Interconnection Facilities constructed and owned by Seller.

**“Seller’s Conditions Precedent Date”** has the meaning set forth in **Section 11.5** (Company Milestones).

**“Site”** means the Company-controlled parcel of real property in Hawi on the Island of Hawai’i on which the Facility will be constructed and located, together with any Land Rights reasonably necessary for the construction, ownership, operation and maintenance of the Facility. The Site is identified in **Attachment A** (Description of Storage Facility) to this Agreement.

**“Source Code”** means the human readable source code of the Required Models which: (a) will be narrated documentation related to the compilation, linking, packaging and platform requirements and any other materials or software sufficient to enable a reasonably skilled programmer to build, modify and use the code within a commercially reasonable period of time for the purposes of a Source Code Authorized Use; and (b) can reasonably be compiled by a computer for execution.

**“Source Code Authorized Use”** has the meaning set forth in **Section 6(b)(i)(E)** (Authorized Use) of **Attachment B** (Facility Owned by Seller).

**“Source Code Escrow”** means the escrow established with the Source Code Escrow Agent under the terms of the Source Code Escrow Agreement under which Source Code shall be confidentially deposited by a Source Code Owner for safekeeping and, upon the satisfaction of certain conditions, release to the Company.

**“Source Code Escrow Agent”** means Iron Mountain Intellectual Property Management Inc., or such other similar escrow agent approved by Company.

**“Source Code Escrow Agreement”** means a multi-party escrow agreement between Company, Source Code Escrow Agent and any and all Source Code Owners depositing Source Code into the Source Code Escrow which, among other matters, names Company as beneficiary thereunder, and is otherwise acceptable in form and substance to Company.

**“Source Code Owner”** means the developer and/or owner of the Required Models utilizing Source Code authorized to deposit the Source Code with the Source Code Escrow Agent upon the terms of the Source Code Escrow Agreement.

**“SOX 404”** has the meaning set forth in **Section 23.1** (Financial Compliance).

**“State of Charge”** or **“SOC”** means the amount of Storage Energy in the Facility stated

as a percentage of the Contract Capacity (e.g., 80% SOC).

**“Station Use”** means the electrical load of the Facility’s auxiliary equipment that are necessary for operation of the Facility as set forth in **Attachment B** (Facility Owned by Seller). The auxiliary equipment includes, but is not limited to, forced and induced draft fans, air conditioner systems, cooling towers, plant lighting and control systems, any heating or cooling equipment necessary to keep energy storage componentry within their normal operating temperatures, any motors or pumps required for moving material within the battery energy storage system, and any other electrical loads required for the Energy Storage Services.

**“Station Use Metering Equipment”** means, for the Facility, a Company-approved revenue quality meter (or meters), Company-approved data processing gateway or remote intelligence gateway, telemetering equipment and data acquisition services sufficient for monitoring, recording and reporting, in real time, all electric energy consumed by the Facility for Station Use.

**“Storage Energy”** means the Energy the Facility can deliver from 100% SOC to 0% SOC.

**“Storage Unit(s)”** means the battery energy storage system unit or units specified in **Attachment A** (Description of Storage Facility) through which Seller has agreed to make available the Energy Storage Services to Company pursuant to this Agreement.

**“Study”** has the meaning set forth in **Section 4(e)** of **Attachment B** (Facility Owned by Seller).

**“Supervisory Control and Data Acquisition”** or **“SCADA”** means the Company system that provides remote control and monitoring of Company’s transmission and sub-transmission systems and enables Company to perform real-time control of equipment in the field and to monitor the conditions and status of the Company System.

**“Submission Notice”** has the meaning set forth in **Section 2(c)** (Appointment of Independent Evaluator) of **Attachment S** (Monthly Reporting and Dispute Resolution by Independent Evaluator) to this Agreement.

**“Subsequent Owner”** has the meaning set forth in **Section 15.4** (Financing Document Requirements).

**“Telemetry and Control”** means the interface between Company’s SCADA and the physical equipment at the Facility.

**“Term”** means, collectively, the Initial Term and the Extended Term (if any).

**“Termination Damages”** means liquidated damages calculated in accordance with **Section 6.5** (Calculation of Termination Damages).

**“Termination Date”** has the meaning set forth in **Section 6.4** (Rights of the Non-Defaulting Party; Forward Contract).

**“Termination Deadline”** means the fourteenth (14<sup>th</sup>) Day following the date the completed IRS is provided to Seller, or such later date as Company and Seller may agree to in writing.

**“Total Actual Relocation Cost”** has the meaning set forth in **Section 5(b)** of **Attachment G** (Company-Owned Interconnection Facilities) to this Agreement.

**“Total Estimated Relocation Cost”** has the meaning set forth in **Section 5(a)** of **Attachment G** (Company-Owned Interconnection Facilities) to this Agreement.

**“Unfavorable PUC Order”** has the meaning set forth in **Section 24.5(e)** (Unfavorable PUC Order).

**“Voltage Regulation”** means the ability to compensate for anomalies or disturbances (e.g., voltage magnitude, harmonics, etc.) to achieve a target voltage at the Point of Interconnection by manipulating the reactive power component of the Facility.

**ATTACHMENT A**  
**DESCRIPTION OF STORAGE FACILITY**

1. Name of Facility: \_\_\_\_\_

(a) Location: \_\_\_\_\_ (TMK No. (3) 5-5-015: 033)

(b) Telephone number (for system emergencies): (\_\_\_\_) \_\_\_\_\_

(c) E-mail Address: \_\_\_\_\_

(d) Contact Information for Notices pursuant to **Section 27.3** (Notices) of the Agreement:

Mailing Address:

\_\_\_\_\_  
\_\_\_\_\_  
\_\_\_\_\_

Address for Hand/Overnight Delivery:

\_\_\_\_\_  
\_\_\_\_\_  
\_\_\_\_\_

E-Mail Address: \_\_\_\_\_

Phone: \_\_\_\_\_

2. Owner (if different from Seller): \_\_\_\_\_

If Seller is not the owner, Seller shall provide Company with a certified copy of a certificate warranting that the owner is a corporation, partnership or limited liability company in good standing with the Hawai'i Department of Commerce and Consumer Affairs which shall be attached hereto as **Exhibit A-1** (Good Standing Certificates).

3. Operator: \_\_\_\_\_

If Seller is not the operator, Seller shall provide a copy of the agreement between Seller and the operator which requires the operator to operate the Facility and which establishes the scope of operations by the operator and the respective rights of Seller and the operator with respect to the availability of Energy Storage Services to Company by the Commercial Operations Date. In addition, Seller shall provide a certified copy of a certificate warranting that the operator is a corporation, partnership or limited liability company in good standing with the Hawai'i Department of Commerce and Consumer Affairs no later than the Commercial Operations Date.

4. Name of person to whom payments are to be made: \_\_\_\_\_

(a) Mailing address:

---

---

---

(b) Hawai'i Gross Excise Tax License number: \_\_\_\_\_

**5. Insurance Carrier(s): [SELLER TO PROVIDE INFORMATION]**

**6.** Seller shall provide a certified copy of a certificate warranting that Seller is a corporation, partnership or limited liability company in good standing with the Hawai'i Department of Commerce and Consumer Affairs which shall be attached hereto as **Exhibit A-1** (Good Standing Certificates).

**7. Ownership Structures:**

(a) Seller, owner and operator shall provide Company a certificate and/or description of their ownership structures which shall be attached hereto as **Exhibit A-2** (Ownership Structures).

(b) In the event of a change in ownership or identity of Seller, owner or operator, such entity shall provide within thirty (30) Days thereof, a certified copy of a new certificate and a revised ownership structure.

**8. Equipment:**

(a) **Reserved.**

(b) Seller may propose revisions to this **Section 8** (Equipment) of **Attachment A** (Description of Storage Facility) ("**Section 8**") for Company's approval prior to commencement of construction, provided, however, that (i) no such revision to this Section 8 shall change the type of Facility or equipment deployed at the Facility from a standalone battery energy storage system; (ii) Seller shall be in compliance with all other terms and conditions of this Agreement; and (iii) such revision(s) shall not change the characteristics of the Facility equipment or the specifications used in the IRS. Any revision to this Section 8 complying with items (i) through (iii) above shall be subject to Company's prior approval, which approval shall not be unreasonably withheld. If Seller's proposed revision(s) to this Section 8 otherwise satisfies items (i) and (ii) above but not item (iii) such that Company, in its reasonable discretion, determines that a re-study or revision to all or any part of the IRS is required to accommodate Seller's proposed revision(s), Company may, in its sole and absolute discretion, conditionally approve such revision(s) subject to a satisfactory re-study or revision to the IRS and Seller's payment and continued obligation to be liable and responsible for all costs and expenses of re-studying or revising such portions of the IRS and for modifying and paying for all costs and expenses of modification to the Facility, the Company-Owned Interconnection Facilities based on the results of the re-studies or revisions to the IRS. Any changes made to this **Attachment A** (Description of Storage Facility) or the Agreement as a result of this **Section 8(b)** of **Attachment A** (Description of Storage Facility)

shall be reflected in a written amendment to the Agreement.

Seller understands and acknowledges that Company's review and approval of Seller's proposed revisions to this Section 8 and any necessary re-studies or revisions to the IRS shall be subject to Company's then-existing time and personnel constraints. Company agrees to use commercially reasonable efforts, under such time and personnel constraints, to complete any necessary reviews, approvals and/or re-studies or revisions to the IRS.

Any delay in completing, or failure by Seller to meet, any subsequent Seller milestones under **Article 11** (Construction Period and Milestones) as a result of any revision pursuant to this Section 8 by Seller (whether requiring a re-study or revision to the IRS or not) shall be borne entirely by Seller and Company shall not be responsible or liable for any delay or failure to meet any such milestones by Seller.

(c) Design and capacity

Energy Storage Capacity ("**Contract Capacity**"): 5 MW / 22 MWh

Total Number of Energy Storage Units:

**[number and size of each Energy Storage Unit. e.g. Five (5) Brand X, 1250 kVA BESS Inverters; each coupled with one (1) Brand Y, 4500 kWh DC BESS Module]**

Description of Equipment:

**[For example: Describe the type of battery energy storage system equipment, operating limitations, plant level control system, and any special features.]**

Maximum Station Use

kW	kVAR Consumed	kVAR Produced
_____	_____	_____

Energy Storage Inverter Unit:

Name of manufacturer: \_\_\_\_\_

Type/Model: \_\_\_\_\_

Rated Power \_\_\_\_\_ kW

Voltage \_\_\_\_\_ V, \_\_\_ phase

Frequency \_\_\_\_\_ HZ

Class of Protection \_\_\_\_\_  
Rated Current \_\_\_\_\_ A  
Rated Power Factor See Exhibit B-2

- (d) The “**Rated Active Power Capacity**” of the Facility is the total possible instantaneous discharge capability in megawatts (MW AC) of the Facility, available at the POI, or the maximum rate of discharge that the Facility can achieve, starting from a fully charged state, and available to Company; considering all Station Use and any equipment limits. The Rated Active Power Capacity shall not be less than the Contract Capacity.

The Rated Active Power Capacity of the Facility shall be: \_\_\_\_\_ kW

- (e) The “**Rated Energy Capacity**” of the Facility is the amount of energy that the Facility is capable of discharging in megawatt-hours (MWh), measured between the maximum and minimum allowable states of charge, and available to the Company; considering all Station Use and any equipment limits. The Rated Energy Capacity shall not be less than the Contract Capacity.

The Rated Energy Capacity of the Facility shall be 22.0 MWh.

- (f) Description of Facility SCADA and control system(s):

**EXHIBIT A-1**  
**GOOD STANDING CERTIFICATES**



**EXHIBIT A-2**  
**OWNERSHIP STRUCTURES**

**[This Attachment will be revised to reflect the results of the IRS]**

**ATTACHMENT B**  
**FACILITY OWNED BY SELLER**

**1. The Facility.**

**(a) Drawings, Diagrams, Lists, Settings and As-Built.**

**(i) Single-Line Drawing, Interface Block Diagram, Relay List, Relay Settings and Trip Scheme.** A preliminary single-line drawing (including notes), Interface Block Diagram, relay list, relay settings, and trip scheme of the Facility shall, after Seller has obtained prior written consent from Company, be attached to this Agreement on the Execution Date as **Attachment E** (Single-Line Drawing and Interface Block Diagram) and **Attachment F** (Relay List and Trip Scheme). A final single-line drawing (including notes), Interface Block Diagram, relay list and trip scheme of the Facility shall, after having obtained prior written consent from Company, be labeled the “Final” Single-Line Drawing, the “Final” Interface Block Diagram and the “Final” Relay List and Trip Scheme and shall supersede **Attachment E** (Single-Line Drawing and Interface Block Diagram) and **Attachment F** (Relay List and Trip Scheme) to this Agreement and shall be made a part hereof on the Commercial Operations Date. After the Commercial Operations Date, no changes shall be made to the “Final” Single-Line Drawing, the “Final” Interface Block Diagram and the “Final” Relay List and Trip Scheme without the prior written consent of Seller and Company. The single-line drawing shall expressly identify the Point of Interconnection of Facility to Company System.

**(ii) As-Built.** Seller shall provide final as-built drawings of the Seller-Owned Interconnection Facilities within 30 Days of the successful completion of the Acceptance Test.

**(iii) Modeling.** Seller shall provide the models as set forth in **Exhibit B-1**.

**(iv) No Material Changes.** Seller agrees that no material changes or additions to the Facility as reflected in the “Final” Single-Line Drawing (including notes), the “Final” Interface Block Diagram, and the “Final” Relay List and Trip Scheme shall be made without Seller first having obtained prior written consent from Company. The foregoing are subject to changes and additions as part of any Performance Standards Modifications. If Company directs any changes in or additions to the Facility, records and operating procedures that are not part of any Performance Standards Modifications, Company shall specify such changes or additions to Seller in writing, and, except in the case of an emergency, Seller shall have the opportunity to review and comment upon any such changes or additions in advance.

**(b) Certain Specifications for the Facility.**

**(i)** Seller shall furnish, install, operate and maintain the Facility, including breakers, relays, switches, synchronizing equipment, monitoring equipment and control and protective devices approved by Company as suitable for parallel

operation of the Facility with Company System. The Facility shall be accessible at all times to authorized Company personnel.

(ii) The Facility shall include:

**[LIST OF THE FACILITY**

**Examples may include, but are not limited to:**

- **Seller-Owned Interconnection Facilities**
- **Substation**
- **Control and monitoring facilities**
- **Transformers**
- **Battery Energy Storage System (“BESS”) equipment (as described in Attachment A)**
- **“Lockable” cabinets or housings suitable for the installation of the Company-Owned Interconnection Facilities located on the Site**
- **Relays and other protective devices**
- **Leased telephone line and/or equipment to facilitate telecommunication]**

(iii) The Facility shall comply with the following **[includes excerpts of language that may be requested by Company]**:

**(A)** Seller shall install a 34.5 kV gang operated, load breaking, lockable disconnect switch and all other items for its switching station (relaying, control power transformers, high voltage circuit breaker). Bus connection shall be made to a manually and automatically (via protective relays) operated high-voltage circuit breaker. The high-voltage circuit breaker shall be fitted with bushing style current transformers for metering and relaying. Downstream of the high-voltage circuit breaker, a structure shall be provided for metering transformers. From the high-voltage circuit breaker, another bus connection shall be made to another pole mounted disconnect switch, with surge protection.

**(B)** Seller shall provide within the Seller-Owned Interconnection Facilities a separate, fenced area with separate access for Company. Seller shall provide all conduits, structures and accessories necessary for Company to install the Revenue Metering Package. Seller shall also provide, within such area, space for Company to install its communications, SCADA equipment (remote terminal unit or equivalent) and certain relaying if necessary for the interconnection. Seller shall also provide AC and DC source lines as specified by Company. Seller shall provide a telephone line for Company-owned meters. Seller shall work with Company to determine an acceptable location and size of the fenced-in area. Seller shall provide an acceptable demarcation cabinet on its side of the fence where Seller and Company wiring will connect/interface.

**(C)** Seller shall ensure that the Seller-Owned Interconnection Facilities have a lockable cabinet for switching station relaying equipment. Seller shall select and install relaying equipment acceptable to Company. At a minimum, the

relaying equipment will provide over and underfrequency (81), negative phase sequence (46), undervoltage (27), overvoltage (59), ground overvoltage (59G), over current functions (50/51) and direct transfer trip (if required). The settings shall be consistent with the requirements for over/underfrequency and voltage ride-through. Seller shall install protective relays that operate a lockout relay (86), which in turn will trip the main circuit breaker and not allow it to be reclosed without reset.

**(D)** High Resolution Data: Seller shall install and make available to the Company time stamped and sequential data recordings for all inverter-based resources (and all generating resources) to perform event analysis and verify Facility performance during steady state and transient disturbance events. This will include a time-synchronized phasor measurement unit at the Facility, and access to multiple sources to provide sufficient clarity as to any abnormal response or behavior within the Facility, including Facility control settings and static values, SCADA data, sequence of events recording (SER) data, dynamic disturbance recorder (DDR) data, and inverter fault codes and inverter-level dynamic recordings. This data will be used to review the Facility's response to system dynamics, such as the frequency response, reactive response, etc.

**(E)** Seller's equipment also shall provide at a minimum:

**(1)** Interface with Company's Telemetry and Control, or designated communications and control interface, to provide telemetry of electrical quantities such as total Facility net MW, MVar, power factor, voltages, currents, and other quantities as identified by the Company.

**(2)** Interface with Company's Telemetry and Control, or designated communications and control interface, to provide status for circuit breakers, reactive devices, switches, and other equipment as identified by the Company.

**(3)** Interface with Company's Telemetry and Control, or designated communications and control interface, to provide control to incrementally raise and lower or send a set point voltage target at the point of regulation operating in automatic voltage regulation control.

**(4)** Interface with Company's Telemetry and Control, or designated communications and control interface, to provide the active power control requirements of this Agreement.

**(5)** Interface with Company's Telemetry and Control, or designated communications and control interface, for the Company to specify control system modes of operation and parameters, for remotely configurable parameters and operating states required under this Agreement.

**(6) Reserved.**

**(7) Provision for Loss of Telemetry and Control:** If Company's Telemetry and Control, or designated communications and control interface, is unavailable, due to loss of communication link, Telemetry and Control

failure, or other event resulting in loss of the remote control by Company, provision must be made for Seller to be able to institute via local controls, within 20 seconds (or such other period as Company accepts in writing) of the detection of such loss of Telemetry and Control.

**(F)** If Seller adds, deletes and/or changes any of its equipment, or changes its design in a manner that would change the characteristics of the equipment and specifications used in the IRS, Seller shall be required to obtain Company's prior written approval. If an analysis to revise parts of the IRS is required, Seller shall be responsible for the cost of revising those parts of the IRS and modifying and paying for the cost of the modifications to the Facility and/or the Company-Owned Interconnection Facilities based on the revisions to the IRS.

**(G) Cybersecurity and Critical Infrastructure Protection.**

**(1) Security Policies and Documentation.** Seller shall implement and document security policies and standards in accordance with industry best practices (e.g., aligned with the intent of NERC CIP-003-8 R2) and consistent with Company's security policies and standards. Seller shall submit documentation describing the approach, methodology and design to provide physical and cyber security (i.e., aligned with the intent of NERC CIP-003-8 R2) with its submittal of the design drawings pursuant to **Section 1(c)** (Design Drawings, Bill of Materials, Relay Settings and Fuse Selection) of **Attachment B** (Facility Owned by Seller) which shall be at least sixty (60) Days prior to the Acceptance Test.

- The design shall meet industry standards and best practices, consistent with the National Institute of Standards and Technology ("**NIST**") guidelines as indicated in Special Publication 800-53 Rev. 4 "Security and Privacy Controls for Federal Information Systems and Organizations" and Special Publication 800-82 Rev. 2 "Guide to Industrial Control Systems (ICS) Security". The system shall be designed with the criteria to meet applicable compliance requirements and identify areas that are not consistent with NIST guidelines and recommendations.

- The cybersecurity documentation shall include a block diagram of the control system with all external connections clearly described.

- Seller shall provide such additional information as Company may reasonably request as part of a security posture assessment.

- Company shall be notified in advance when there is any condition that would compromise physical or cyber security.

- Seller shall, at the request of Company or, in the absence of any request from Company, at least annually, provide Company with updated documentation and diagrams including a record of changes.

**(2) Network and Application Security.** Seller shall implement appropriate network and application security processes and practices

commensurate with the level of risk as determined by periodic risk assessments (i.e., aligned with the intent of NERC CIP-005-5):

- Segment and segregate networks and functions, including physical and logical separation between business networks and control system networks (i.e., aligned with the intent of NERC CIP-005-5 R1).
- Limit unnecessary lateral communications (i.e., aligned with the intent of NERC CIP-005-5 R1).
- Harden network devices (i.e., aligned with the intent of NERC CIP-007-6 R1).
- Secure access to infrastructure devices (i.e., aligned with the intent of NERC CIP-004-6 R4).
- Perform out-of-band (OoB) network management (i.e., aligned with the intent of NERC CIP-005-5 R2).
- Validate integrity of hardware and software (i.e., aligned with the intent of NERC CIP-010-3 R1 and NERC CIP-006-6 R1 Part 10).

**(3) Endpoint and Server Security.** Seller shall implement appropriate endpoint and server security processes and practices commensurate with the level of risk as determined by periodic risk assessments:

- Mechanisms to identify vulnerabilities and apply security patches in a timely manner (i.e., aligned with the intent of NERC CIP-007-6 R2).
- Malware defense and anti-phishing capabilities (i.e., aligned with the intent of NERC CIP-007-06 R3).
- Access Controls to enforce the least privilege principle and provide access to resources only for authorized users (i.e., aligned with the intent of NERC CIP-004-6 R4).
- Secure authentication mechanisms including multi-factor authentication for systems with higher risk exposure (i.e., aligned with the intent of NERC CIP-007-6 R5 and NERC CIP-005-5 R2).
- Data confidentiality, protection, and encryption technologies for endpoints, servers, and mobile devices (i.e., aligned with the intent of NERC CIP-011-2 R1 and NERC CIP-005-5 R2).

Seller shall (consistent with the following sentence) ensure that no malicious software (“**Malware**”) or unauthorized code is introduced into any aspect of the Facility, Interconnection Facilities, the Company Systems interfacing with the Facility and Interconnection Facilities, and any of Seller’s critical control systems or processes used by Seller to provide energy, including the information, data

and other materials delivered by or on behalf of Seller to Company, (collectively, the “**Environment**”). Seller shall periodically review, analyze and implement improvements to and upgrades of its Malware prevention and detection programs and processes that are commercially reasonable and consistent with the then current technology industry’s standards and, in any case, not less robust than the programs and processes implemented by Seller with respect to its own information systems.

**(4) Cybersecurity Program.** Seller shall establish and maintain a continuous cybersecurity program (i.e., aligned with the intent of NERC CIP-003-8) that enables the Seller (or its designated third party) to:

(aa) Define the scope and boundaries, policies, and organizational structure of the cybersecurity program.

(bb) Conduct periodic risk assessments to identify the specific threats to and vulnerabilities of the Seller’s Organization consistent with guidance provided in NIST Special Publication 800-30 Rev. 1 “Guide for Conducting Risk Assessments”.

(cc) Implement appropriate mitigating controls and training programs and manage resources.

(dd) Monitor and periodically test the cybersecurity program to ensure its effectiveness. Seller shall review and adjust their cybersecurity program as appropriate for any assessed risks.

(ee) Applicability is extended to Cloud Service providers and other third-party services the Seller may use.

**(5) Security Monitoring and Incident Response.** Company and Seller shall collaborate on security monitoring and incident response, define points of contact on both sides, establish monitoring and response procedures, set escalation thresholds, and conduct training (i.e., aligned with the intent of NERC CIP-008-5). Seller shall, at the request of Company or, in the absence of any request from Company, at least quarterly, provide Company with a report of the incidents that it has identified and describe measures taken to resolve or mitigate.

In the event that Seller discovers or is notified of a breach, potential breach of security, or security incident at Seller’s Facility or of Seller’s systems, Seller shall immediately (aa) notify Company of such potential, suspected or actual security breach, whether or not such breach has compromised any of Company’s confidential information, (bb) investigate and promptly remediate the effects of the breach, whether or not the breach was caused by Seller, (cc) cooperate with Company with respect to any such breach or unauthorized access or use; (dd) comply with all applicable privacy and data protection laws governing Company’s or any other individual’s or entity’s data; and (ee) to the extent such breach was caused by Seller, provide Company with reasonable assurances satisfactory to Company that such breach, potential breach, or security incident shall not recur. Seller shall provide documentation to Company evidencing the length and impact of the breach. Any remediation of any such breach will be at Seller’s sole expense.

If malicious software or unauthorized code is found to have been introduced into the Environment, Seller will promptly notify Company. Seller shall take immediate action to eliminate and remediate the effects of the Malware, at Seller's expense. Seller shall not modify or otherwise take corrective action with respect to the Company Systems except at Company's request. Seller shall promptly report to Company the nature and status of all efforts to isolate and eliminate malicious software or unauthorized code.

**(6) Monitoring and Audit.** Seller shall provide information on available audit logs and reports relating to cyber and physical and security (i.e., aligned with the intent of NERC CIP-007-06 R4). Company may audit Seller's records to ensure Seller's compliance with the terms of this **Section 1(b)(iii)(G)** (Cybersecurity and Critical Infrastructure Protection) of this **Attachment B** (Facility Owned by Seller), provided that Company has provided reasonable notice to Seller and any such records of Seller's will be treated by Company as confidential.

**(7) Contingency Plans.** Seller shall implement and maintain a business continuity plan, a disaster recovery plan, and an incident response plan ("**Contingency Plans**" – i.e., aligned with the intent of NERC CIP-009-6) appropriate for the level of risk based on the impact of Seller's associated facilities, systems and equipment, which, if destroyed, degraded, misused, or otherwise rendered unavailable, would affect the reliable operation of the Company System. The Contingency Plans shall be provided to Company upon request. Such Contingency Plans shall be updated to reflect lessons learned from real recovery events.

**(8) Supply Chain Risk Management.** Seller shall implement and maintain a supply chain risk management plan with implementation of appropriate security controls (i.e., aligned with the intent of NERC CIP-013-1). Controls should address the following security considerations: (aa) software integrity and authenticity; (bb) vendor remote access; (cc) information system planning; and (dd) vendor risk management and procurement controls.

**(H) Available Power Production.** Seller's available power production considering state of charge (Power Possible) will be supplied as an accurate representation of the amount of maximum and minimum (negative) available active power at the Point of Interconnection (plus or minus 0.1 MW) and the duration available at the current dispatch.

**(I)** Seller shall reserve space within the Site for possible future installation of Company-owned meteorological equipment (such as wind speed, direction and relative humidity monitors, SODAR and irradiance monitors) and AC and DC source lines for such equipment as may be required depending on the Facility resource type and location. In the event Company decides to install such meteorological equipment: (i) Seller shall work with Company to determine an acceptable location for such equipment and any associated wiring, interface or other components; and (ii) Company shall pay for the needed equipment, and installation of such equipment, unless otherwise agreed to by the Parties. Company and Seller shall use commercially reasonable efforts to facilitate installation and minimize interference with the operation of the Facility.



**(J)** The Facility shall, a minimum, satisfy the wind load and seismic load requirements of the International Building Code and any more stringent requirements imposed under applicable Laws.

**(c) Design Drawings, Bill of Material, Relay Settings and Fuse Selection.** Seller shall provide to Company for its review the design drawings, Bill of Material, relay settings and fuse selection for the Facility, and Company shall have the right, but not the obligation, to specify the type of electrical equipment, the interconnection wiring, the type of protective relaying equipment, including, but not limited to, the control circuits connected to it and the disconnecting devices, and the settings that affect the reliability and safety of operation of Company's and Seller's interconnected system. Seller shall provide the relay settings and protection coordination study, including fuse selection and AC/DC Schematic Trip Scheme (part of design drawings), for the Facility to Company during the 60% design. Company, at its option, may, with reasonable frequency, witness Seller's operation of control, synchronizing, and protection schemes and shall have the right to periodically re-specify the settings. Seller shall utilize relay settings prescribed by Company, which may be changed over time as Company System requirements change.

**(d) Disconnect Device.** Seller shall provide a manually operated disconnect device which provides a visible break to separate Facility from Company System. Such disconnect device shall be lockable in the OPEN position and be readily accessible to Company personnel at all times.

**(e) Other Equipment.** Seller shall install, own and maintain the infrastructure associated with the Revenue Metering Package, including but not limited to all enclosures (meter cabinets, meter pedestals, meter sockets, pull boxes, and junction boxes, along with their grounding/bonding connections), CT/PT mounting structures, conduits and ductlines, enclosure support structures, ground buses, pads, test switches, terminal blocks, isolation relays, telephone surge suppressors, and analog phone lines (one per meter), subject to Company's review and approval.

**(f) Maintenance Plan.** Seller shall maintain Seller-Owned Interconnection Facilities in accordance with Good Engineering and Operating Practices.

**(g) Active Power Control Interface. [COMPANY TO REVISE THIS SECTION BASED ON SPECIFICS OF THE PROJECT.]**

**(i)** Seller shall provide and maintain in good working order all equipment, computers and software associated with the control system (the "**Active Power Control Interface**") necessary to interface the Facility active power controls with the Company SCADA System for real power control of the Facility by the Company System Operator.

The detailed design will be tailored to the specific resource type and configuration to achieve the functional requirements of the Facility.

The Active Power Control Interface will be used to control the net real power export or import of the Facility for Back-up Power, Frequency Regulation,

Black-Start, load following, system balancing and/or supplemental frequency control as required under this **Attachment B** (Facility Owned by Seller) and/or any other uses the Facility can provide that would benefit the Company's distribution or transmission system.

The Facility real power output or import will automatically adjust to a change in frequency in accordance with the frequency response requirements provided in this **Attachment B** (Facility Owned by Seller).

**(ii)** Company shall review and provide prior written approval of the design for the Active Power Control Interface to ensure compatibility with Company's centralized control systems and use of Facility available energy and storage capabilities. To ensure such continued compatibility, Seller shall not materially change the approved design without Company's prior review and written approval. This will include design description and parameters for the Seller's control system(s), which determine provision of net real power from the BESS, and charging of the BESS, in response to the Active Power Control signal or signals.

**(iii)** The Active Power Control Interface shall include, but not be limited to, a demarcation cabinet, ancillary equipment and software necessary for Seller to connect to Company's Telemetry and Control, located in Company's portion of the Facility switching station which shall provide the control signals to the Facility and send feedback status to the Company System Operations Control Center. The control type shall be analog output (set point) or raise/lower controls and will be established by the Company prior to final design approval.

**(iv)** The Active Power Control Interface shall also include provision for feedback points from the Facility indicating active power target in MW for the Active Power Control signal(s). The Facility shall provide the MW target feedback to the Company SCADA system immediately upon receiving the respective control signal from the Company.

**(v)** Seller shall provide to the telemetry interface analogs for the gross production of the energy resource(s) at the Facility (for example, gross ACMW of the BESS, etc.) Seller shall also provide the total net AC MW production at the Point of Interconnection.

**(vi)** The Active Power Control Interface shall provide for remote control of the real-power output of the Facility by the Company at all times. If the Active Power Control Interface is unavailable or disabled, the Facility may not export electric energy to Company and the Facility shall be deemed to be in Seller-Attributable Unavailability status. If Seller fails to provide such remote control capability (whether temporarily or throughout the Term), then, notwithstanding any other provision of this **Attachment B** (Facility Owned by Seller), Company shall have the right to derate or disconnect the entire Facility during those periods that such control capability is not provided and the Facility shall be deemed to be in Seller-Attributable Unavailability status for such periods.

**(vii)** The rate at which the Facility changes net real power in response to the active power control shall not be less than 2 MW per minute and shall make

available through agreed parameters, such as faster ramp as the installed equipment can support. The Facility's Active Power Control Interface will be used by Company to control the rate at which electric energy is changed to achieve the active power reference setpoint for load-following and regulation. The Facility will respond to the active power control request immediately with an echo of the set point and measurable change within the microgrid controller control cycle.

**(viii)** The Facility shall accept the following controls related to active power control and frequency response to or from the Company centralized control system:

- Power Reference Setpoint from Company (based on the input to the Facility, from the Active Power Control Interface): The Facility output shall match this setting from the BESS so long as it can be supported by the BESS State of Charge (Power Possible does not change). This net output should be accurate within +/- 0.05 MW under normal frequency conditions. This setpoint will be modified as appropriate in the controls by the appropriate frequency response consistent with **Section 1(g)(xi)** (Active Power – Frequency Response (DROOP)), **Section 1(g)(xii)** (Dynamic Active Power – Frequency Performance), and **[FOR FACILITIES WITH STORAGE] Section 1(g)(xiii)** (Alternate Active Power / Frequency Response Modes) of this **Attachment B** (Facility Owned by Seller).

- From Company: Frequency Response Mode (DROOP Grid Connected, isochronous microgrid islanded, black start, synch to grid, disabled) state.

- From Seller:
  - Power Possible (Available maximum capacity): See above, instantaneous limit for available energy, represents max level the Facility can produce under present BESS State of Charge and equipment conditions. This is used as upper limit for Company Dispatch.

- Minimum Sustained Limit: Minimum output level the Facility can be reduced to continuously without delay (ecomn). If BESS charging capacity is available, this will be a negative value.

- Minimum Transient Limit (for frequency response, regulation) (lfcmn). If BESS charging capacity is available, this will be a negative value.

- Maximum Dispatchable Ramp Rate: Controlled ramp rate available for controlled changes in output.

- BESS potential (BESS State of Charge and projected number of hours at present dispatch, minimum dispatch, and maximum dispatch).

- Frequency Response Mode (DROOP Grid Connected, isochronous microgrid islanded, black start, synch to grid, disabled) state.

**(ix)** Seller shall not override Company's active power controls without

first obtaining specific approval to do so from the Company System Operator unless there is a system emergency. Disabling of the remote Active Power Control shall initiate telemetry notification to the Company.

**(x)** The requirements of the Active Power Control Interface may be modified as mutually agreed upon in writing by the Parties.

**Active Power Communications between Company and Seller**

Company will receive and send Set-Point and related data through the communications interface in accordance with Company standards. The data points covered under this Agreement, as described below, may overlap with data requirements described elsewhere.

**Data Points to be sent from Seller to Company via SCADA**

The following data points will be transmitted via SCADA from Seller to Company and represent Facility level data **[Note: May be modified based on resource type and Facility requirements]:**

<u>Description</u>	<u>Units</u>
Power Reference Set-Point (echo)	MW
Station Use	MW
Actual power output	MW
Power Possible	MW
Actual reactive power output	Mvars
3 phase Voltages	Kv
BESS State of Charge	Pct
BESS Inverters online	Integer
Facility duration at current output	HRS
Active Power Control Status	Remote/Local
Indication of Frequency Response Mode	Integer DROOP Grid Connected,

	isochronous microgrid islanded, black start, synch to grid, disabled
Target Frequency (Isochronous)	Hz

**Response times and limitations of Facility in regards to Active Power Control**

The following protocols outline the expectations for responding to the Power Reference Set-Point.

Frequency of Changes. Company may send a new Power Reference Set-Point to the Facility at up to the microgrid control cycle.

Range of Power Reference Set-Point. The range of set point values can be between -100% and 100% of Power Possible.

**(xi) Active Power - Frequency Response Modes**

The Facility will provide the capability to supply DROOP Grid Connected, isochronous islanded microgrid, black start, synch to grid, or disable frequency response modes of operation, which can be set remotely. The control design shall allow for a bumpless transfer between modes of operation.

- **DROOP Grid Connected.** The Facility shall provide a primary frequency response with a frequency droop characteristic reacting to system frequency at the Point of Interconnection in both the overfrequency and underfrequency directions except as limited by the minimum and maximum available capacity and energy potential at the time of the event including BESS state of charge. This response must be timely and sustained rather than injected for a short period and then withdrawn. For over-frequency events, response may include absorption through charging (as applicable under the terms of this Agreement). Seller shall provide minimum operational limits for each online resource and the Facility for primary frequency response.

Frequency will be calculated over a period of time (e.g., three to six cycles, or other period as specified by Company), and filtered to take control action on the fundamental frequency component of the calculated signal. Calculated frequency may not be susceptible to spikes caused by phase jumps on the Company system.

The active power-frequency control system, and overall response of the inverter-based resource (plant), must meet the following performance aspects (see figure below):

The active power-frequency control system shall have an adjustable proportional droop characteristic with a default value of [4%] percent. The droop setting shall permit a setting from 0.1% to 10%. This setting shall be changed upon Company's written request as necessary for grid droop response coordination. The droop setting shall be tunable and may be specified during commissioning. The droop shall be a permanent value based on Pmax (Rated Active Power Capacity) and Pmin (0). This keeps the proportional droop constant across the full range of operation. The curve for an inverter-based BESS may include the negative active power quadrant of this curve. The droop response must include the capability to respond in both the upward (underfrequency) and downward (overfrequency) directions. Frequency droop will be based on the difference between Rated Active Power Capacity (Pmax) and zero output (Pmin) such that the [4%] percent droop line is always constant for a resource.

Seller shall make commercially reasonable efforts to provide frequency response without a deadband, but in any case, not to exceed +/- 0.0166 Hz. If the active power-frequency control system has a deadband, it shall be a nonstep deadband that is adjustable between 0 Hz and the full frequency range of the droop characteristic. A nonstep deadband is where the change in active power output starts from zero deviation on either side of the deadband. Frequency deadband is the range of frequencies in which the unit does not change active power output.

Inverter-based resources may consider a small hysteresis characteristic where linear droop meets any deadband to reduce dithering of inverter output when operating near the edges of the deadband. The hysteresis range may not exceed  $\pm 0.005$  Hz on either side of the deadband. If measurement resolution is not sufficient to measure this frequency, hysteresis may not be used.

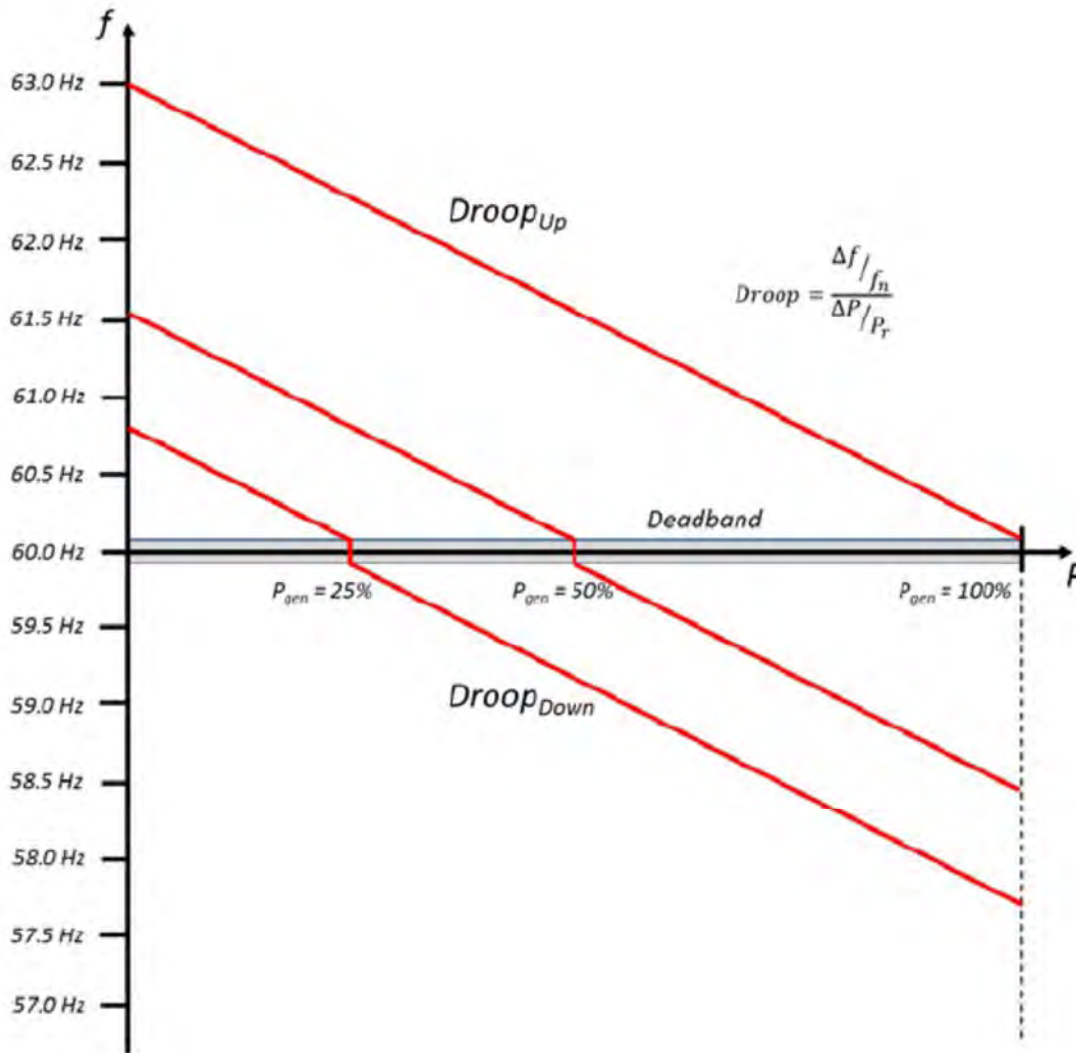

### Active Power - Frequency Control Characteristic

Nominal System Frequency is 60.00 Hz.

The closed-loop dynamic response of the active power-frequency control system of the overall inverter-based resources, as measured at the POI must have the capability to meet or exceed the performance specified in below. Seller shall ensure that the models and parameters for the resources and control equipment are consistent with those provided during the IRS process and that any updates have been provided to the Company reflecting currently implemented settings and configuration.

- Isochronous Islanded Microgrid: The Facility will be capable of operating in a zero droop (isochronous) mode of operation. When in this mode of operation, the frequency droop characteristic will be configured as needed to keep system

frequency at a target. If isochronous islanded microgrid is specified while in operation, the target shall be initialized to the grid frequency and the target increased or decreased from the Company System through the control interface.

- Black Start. It is required that the BESS be capable of black start, that is self-starting in the absence of a grid connection, but only in the designed microgrid island mode and is not required as a “cranking path” to facilitate the starting of other grid-connected generators. The black start energization of the North Kohala 34kV Microgrid or Hawi Microgrid should be achieved in a controlled method that ensures the BESS remains in operation for all transformer energizations and load additions and minimizes observable power quality deviations for customers connected in the microgrid as transformers and loads are energized. In a black-start configuration, upon successful energization of the microgrid area the frequency response mode shall automatically transition to isochronous islanded microgrid mode, and the target frequency shall be 60 Hz.
- Synch to Grid. Additionally a synchronize to grid mode of operation is to be provided to control active power and frequency in reference to the grid frequency to facilitate the closing of the synchronizing device of interest.

**(xii) Dynamic Active Power-Frequency Performance.** For a step change in frequency at the point of measure of the inverter-based resource **[NOTE - MAY BE ADJUSTED AS THE RESULT OF IRS]:**

Reaction time: The time between a step change in frequency and the time when the resource active power output begins responding to the change shall be less than 500 Ms, or as otherwise specified by Company.<sup>1</sup>

Rise time: The time when the resource has reached 90% of the new steady-state (target) active power output shall be less than 4 seconds, or as otherwise specified by Company.<sup>2</sup>

Settling Time: Time in which the resource has entered into, and remains within, the settling band of the new steady-state active power (target) output shall be less than 10 seconds, or as otherwise specified by Company.

Overshoot: Percentage of the rated active power output that the resource can exceed while reaching the settling band shall be less than 5% or as

---

<sup>1</sup> Time between step change in frequency and the time to 10 percent of new steady-state value can be used as a proxy for determining this time.

<sup>2</sup> Percentage based on final (expected) settling value.



otherwise specified by Company.<sup>3</sup>

Settling Band: Percentage of rated active power output that the resource should settle to within the settling time shall be less than 2.5%.

When operating in parallel with the Company System, the Facility shall operate with its primary frequency response control in automatic operation and in accordance with Company directions. Notification of changes in the status of the frequency response controls and, where applicable, mode of operation must be provided to the Company System Operator immediately through SCADA telemetry indication.

The Facility frequency response control shall adjust, without intentional delay and without regard to the ramp rate limits in **Section 3(c)** (Ramp Rates) of this **Attachment B** (Facility Owned by Seller), the Facility's net real power export based on frequency deadband and frequency droop settings specified by the Company.

The Facility frequency response control shall increase the net real power export above the Power Reference Setpoint set under **Section 1(g)(viii)** of this **Attachment B** (Facility Owned by Seller) or further decrease the net real power export from the Power Reference Limit in its operations in accordance with the frequency response settings.

The Facility frequency response control shall be in continuous operation unless directed otherwise by the Company.

**(h) Control System Acceptance Test Procedures.**

**(i) Conditions Precedent.** The following conditions precedent must be satisfied prior to conducting the Control System Acceptance Test:

- Successful completion of the Acceptance Test;
- Facility has been successfully energized;
- All of the Facility's BESS have been fully commissioned;
- The control system computer has been programmed for normal operations; and
- All equipment that is relied upon for normal operations (including ancillary devices such as capacitors/inductors, energy storage device, statcom, etc.) shall have been commissioned and be operating within normal parameters.

**(ii) Facility Energy Equipment.** In the event that all or any portion of the Facility's energy equipment is not available for the duration of the Control

---

<sup>3</sup> Percentage based on final (expected) settling value.

System Acceptance Test, the Control System Acceptance Test will have to be re-run from the beginning unless Seller demonstrates to the satisfaction of the Company that the test results attained are consistent with the results that would have been attained if all of the equipment had been available for the duration of the test.

**(iii) Procedures.** The Control System Acceptance Test will be conducted on Business Days during normal working hours on a mutually agreed upon schedule. No Control System Acceptance Test will be scheduled during the final 21 Days of a calendar year. No later than thirty (30) Days prior to conducting the Control System Acceptance Test, Company and Seller shall agree on a written protocol setting out the detailed procedure and criteria for passing the Control System Acceptance Test. **Attachment O** (Control System Acceptance Test Criteria) provides general criteria to be included in the written protocol for the Control System Acceptance Test. Within fifteen (15) Business Days of completion of the Control System Acceptance Test, Company shall notify Seller in writing whether the Control System Acceptance Test(s) has been passed and, if so, the date upon which such Control System Acceptance Test(s) was passed. If any changes have been made to the technical specifications of the Facility or the design of the Facility in accordance with **Section 8(b)** of **Attachment A** (Description of Storage Facility), such changes shall be reflected in an amendment to this Agreement, and the written protocol for the Control Systems Acceptance Test shall be based on the Facility as modified. Such amendment shall be executed prior to conducting the Control System Acceptance Test and Company shall have no obligation for any delay in performing the Control Systems Acceptance Test due to the need to complete and execute such amendment.

**(i) Facility Security and Maintenance.** Seller is responsible for securing the Facility. Seller shall have personnel available to respond to all calls related to security incidents and shall take commercially reasonable efforts to prevent any security incidents. Seller is also responsible for maintaining the Facility, including vegetation management, to prevent security breaches. Seller shall comply with all commercially reasonable requests of Company to update security and/or maintenance if required to prevent security breaches.

**(j) Demonstration of Facility.** Company shall have the right at any time, other than during maintenance or other special conditions communicated by Seller, to notify Seller in writing of Seller's failure, as observed by Company and set forth in such written notice, to meet the operational and performance requirements specified in **Section 1(g)** (Active Power Control Interface) and **Section 3** (Performance Standards) of this **Attachment B** (Facility Owned by Seller), and to require documentation or testing to verify compliance with such requirements. Upon receipt of such notice, Seller shall promptly investigate the matter, implement corrective action and provide to Company, within thirty (30) Days of such notice, a written report of both the results of such investigation and the corrective action taken by Seller; provided, that, if thirty (30) Days is not a reasonable time period to investigate the matter, implement corrective action and provide such written report, Seller shall complete the foregoing within such longer commercially reasonable period of time agreed to by the Parties in writing. If the Seller's report does not resolve the issue to Company's reasonable satisfaction, the Parties shall promptly commission a study to be performed by one of the engineering firms then included on the Consultants List to evaluate the cause of the non-compliance and to make recommendations to remedy

such non-compliance. Seller shall pay for the cost of the study. The study shall be completed within ninety (90) Days, unless the selected consultant determines such study cannot reasonably be completed within ninety (90) Days, in which case, such longer period of time as the selected consultant determines is necessary to complete such study shall apply. The consultant shall send the study to Company and Seller. Seller (and/or its third-party consultants and contractors), at Seller's expense, shall take such action as the study shall recommend with the objective of resolving the non-compliance. Such recommendations shall be implemented by Seller to Company's reasonable satisfaction no later than forty-five (45) Days from the Day the completed study is issued by the consultant, unless such recommendations cannot reasonably be implemented within forty-five (45) Days, in which case, Seller shall implement such recommendations within such longer commercially reasonable period of time agreed to by the Parties in writing. Failure to implement such recommendations within this period shall constitute a material breach of this Agreement. Unless the aforementioned written report and study are being completed, Company shall have the right to declare the Facility derated and in Seller-Attributable Unavailability status until the Seller's aforementioned written report has been completed, any subsequent study commissioned by the Parties has been completed and any recommendations to resolve the non-compliance have been implemented to Company's reasonable satisfaction.

**2. Operating Procedures. [NOTE: NUMERICAL SPECIFICATIONS IN THIS SECTION 2 MAY VARY DEPENDING ON THE SPECIFIC PROJECT AND THE RESULTS OF THE PROJECT-SPECIFIC IRS.]**

**(a) Reviews of the Facility.** Company may require periodic reviews of the Facility, maintenance records, available operating procedures and policies, and relay settings, and Seller shall implement changes Company deems necessary for parallel operation or to protect the Company System from damages resulting from the parallel operation of the Facility with the Company System.

**(b) Separation.** Seller must separate from the Company System whenever requested to do so by the Company System Operator pursuant to **Article 12** (Dispatching and Charging the Facility; Scheduling) and **Article 16** (Personnel and System Safety) of the Agreement.

**(c) Seller Logs.** Logs shall be kept by Seller for information on unit availability including reasons for planned and forced outages, circuit breaker trip operations, relay operations, including target initiation, and other unusual events. Company shall have the right to review these logs, especially in analyzing system disturbances. Seller shall maintain such records for a period of not less than six (6) years.

**(d) Reclosing and Return to Service.** Under no circumstances shall Seller, when separated from the Company System for any reason, including tripping during disturbances or due to equipment failure, reclose into the Company System without first obtaining specific approval to do so from the Company System Operator. Ramp rates, behavior and mode of operation upon return to service shall conform to verbal instructions from the System Operator or Active Power control from Company.

(e) **Reserved.**

(f) **Reserved.**

(g) **Critical Infrastructure Protection.** Seller shall comply with the critical infrastructure protection requirements set forth in **Section 1(b)(iii)(G)** (Cybersecurity and Critical Infrastructure Protection) of this **Attachment B** (Facility Owned by Seller).

(h) **Allowed Operations.** Facility shall be allowed to import energy from or export energy to the Company System only when the Active Power Control Interface is in service. **[TO BE DETERMINED BY COMPANY BASED ON THE RESULTS AND REQUIREMENTS OF THE IRS.]**

### **3. Performance Standards.**

(a) **Reactive Power Control.** Seller shall control its reactive power by automatic voltage regulation control. Seller shall automatically regulate voltage at a point, the point of regulation, between the Seller's Inverter terminal(s) and the Point of Interconnection to be specified by Company, to within 0.5% of a voltage specified by the Company SCADA System to the extent allowed by the Facility reactive power capabilities as defined in **Section 3(b)** (Reactive Power Characteristics) of this **Attachment B** (Facility Owned by Seller)

(b) **Reactive Power Characteristics. [THESE REQUIREMENTS MAY BE CHANGED BY COMPANY UPON COMPLETION OF THE IRS.]**

(i) The Facility shall install sufficient equipment so that the Facility will have the ability to deliver or receive, at the point of interconnection, reactive power as illustrated in the **[BESS Inverter capability]** curve(s) attached to this Agreement as **Exhibit B-2**, which represents the Facility Composite (Energy Storage Capability Curve(s)). The Facility when charging (that is operating with negative active power) shall provide automatic voltage control within their reactive capability while acting as a load). The automatic voltage control aspects of a BESS shall be seamless across the transition from acting as a generating resource to acting as a load. The Facility must be capable of automatically adjusting reactive control to maintain the bus voltage at the Point of Interconnection to meet the scheduled voltage set point target specified by the Company SCADA System and be capable of supplying reactive power in accordance with the **[BESS Inverter capability]** curve(s) attached to this Agreement as Exhibit B-2 including capability to continue to provide reactive compensation at all active power outputs down to zero active power. The voltage target will be specified remotely by the Company SCADA System. The Facility's voltage set point target must reflect the Company voltage set point target controlled from SCADA, without delay. The Facility should not normally operate on a fixed var or fixed power factor unless agreed by Company. The voltage setpoint target and present Facility minimum and maximum reactive power limits based on the Facility Composite capability curve shall be provided to the Company through Company's Telemetry and Control.

(ii) The Facility shall contain equipment able to continuously and actively control the output of reactive power under automatic voltage regulation control reacting to system voltage changes. The response requirements are

differentiated for large and small signal disturbance performance characteristics. Small signal disturbances are those that reflect normal variations under non-disturbance conditions, the continuous operation range for voltage ride through:  $0.80 \text{ pu} \leq V \leq 1.00 \text{ pu}$  at the point of interconnection. Large disturbance is where the voltage at the point of interconnection falls outside the continuous operating range.

**(iii)** For small signal disturbances, reaction time between the step change in voltage and the reactive power change shall be less than 500 msec (no intentional time delay). The automatic voltage regulation response speed at the point of regulation shall be such that at least 90% of the initial voltage correction needed to reach the voltage control target will be achieved within 1 second following a step change. The percentage of rated reactive power output that the resource can exceed while reaching the settling band shall be less than five percent (5%).

**(iv)** Large disturbances: Large disturbances are characterized by voltage falling outside of the continuous operating range. The Facility shall adhere to the following characteristics for large disturbances:

The response of each generating resource over its full operating range and for all expected grid conditions should be stable. The dynamic performance of each resource should be tuned to provide this stable response. Company will work with Seller to ensure during the interconnection process that each resource supports Company System reliability and provides a stable transient response to grid events. **[Note - The performance specifications described here may need to be modified based on studies performed for specific interconnections to provide a stable response.]**

Inverter-based resources shall operate in closed loop automatic voltage control at all times to support voltage regulation and voltage stability. Either the individual inverters or the plant-level closed loop automatic voltage controller must operate with a relatively fast response characteristic to mitigate steady-state voltage issues from causing dynamic voltage collapse. The plant-level controller may send voltage or reactive power set point changes to the individual inverters relatively fast, or the inverters will respond locally (depending on control architecture).

For a large disturbance step in voltage, measured at the inverter terminals, where voltage falls outside the continuous operating range, the positive sequence component of the inverter reactive current response must meet the performance specifications set forth below. These parameters may be adjusted following additional study and/or operational testing and performance.

Reaction time: Time between the step change in voltage and when the resource reactive power output begins responding to the change. The reaction time shall be less than 16 msec.

Rise time: Time between a step change in control signal input and when

the reactive power output changes by 90 percent of its final value. The rise time shall be less than 100 msec.

Overshoot: Percentage of rated reactive current output that the resource can exceed when reaching the settling band. Overshoot will be determined following the IRS such that any overshoot in reactive power response does not cause Company System voltages to exceed acceptable voltage limits. The magnitude of the dynamic response may be requested to be reduced based on stability studies or actual operational data review.

(v) If the Facility does not operate in accordance with **Section 3(b)** (Reactive Power Characteristics) of this **Attachment B** (Facility Owned by Seller), Company may disconnect all or a part of Facility from Company System until Seller corrects its operation (such as by installing supplemental reactive power equipment or additional controls modifications, at Seller's expense).

(c) **Ramp Rates.** Seller shall ensure that the ramp rate of the Facility is less 2 MW a minute for all conditions other than those under control of the Company System Operator and/or those due to desired frequency response, including start up, depletion of storage charge and resource, locally controlled startup and shut down.

(d) **Ride-Through.** Ride-Through requires that the resource continues to inject current within the "No Trip" zone of the voltage and frequency ride-through requirements. Unless approved during the Interconnection Requirements Study analysis, resources should not use "momentary cessation" within the ride-through regions for any of the ride-through requirements in this **Attachment B** (Facility Owned by Seller).

(e) **Undervoltage Ride-Through.** The Facility, as a whole, will meet the following undervoltage ride-through requirements during low voltage affecting one or more of the three voltage phases ("V" is the voltage of any three voltage phases at the Point of Interconnection). For alarm conditions the Facility shall not disconnect from the Company System unless the Facility's equipment is at risk of damage. This is necessary in order to coordinate with the existing Company System. **[THESE VALUES MAY BE CHANGED BY COMPANY UPON COMPLETION OF THE IRS. WITHOUT LIMITATION, FOR A DISTRIBUTION-CONNECTED FACILITY, UPON COMPLETION OF THE IRS THE COMPANY MAY SPECIFY REQUIREMENTS FOR A MANDATORY DISCONNECTION FROM THE COMPANY SYSTEM.]**:

0.80 pu $\leq$ V $\leq$ 1.00 pu	The Facility remains connected to the Company System and in continuous operation.
0.70 pu $\leq$ V < 0.80 pu	The Facility remains connected to the Company System and in continuous operation for a minimum of 20 seconds per event (while "V" remains in this range).
0.50 pu $\leq$ V < 0.70 pu	The Facility remains connected to the Company System and in continuous operation for a minimum

of 10 seconds per event (while "V" remains in this range).

0.00 pu  $\leq$  V < 0.50 pu      The Facility remains connected to the Company System and in continuous operation for a minimum of 600 milliseconds per event (while "V" remains in this range).

Protective Undervoltage Relaying (27) shall be set to alarm only to meet the above ride-through requirements, and shall not initiate a disconnect from the Company System unless Seller reasonably determines based upon Good Engineering and Operating Practices that the Facility's equipment is at risk of damage. This is necessary in order to coordinate with the existing Company System.

Seller shall have sufficient capacity to fulfill the above mentioned requirements to ride-through subsequent events 300 cycles or more apart, between which the voltage at the POI recovers above 0.80 pu. **[THE ACTUAL RIDE-THROUGH TIMES WILL BE DETERMINED BY COMPANY IN CONNECTION WITH THE IRS]**

**(f) Over Voltage Ride-Through.** The overvoltage protection equipment at the Facility shall be set so that the Facility will meet the following overvoltage ride-through requirements during high voltage affecting one or more of the three voltage phases (as described below) ("V" is the voltage of any of the three voltage phases at the Point of Interconnection). For alarm conditions the Facility should not disconnect from the Company System unless the Facility's equipment is at risk of damage. This is necessary in order to coordinate with the existing Company System. **[THESE VALUES MAY BE CHANGED BY THE COMPANY UPON COMPLETION OF THE IRS. WITHOUT LIMITATION, FOR A DISTRIBUTION-CONNECTED FACILITY, UPON COMPLETION OF THE IRS THE COMPANY MAY SPECIFY REQUIREMENTS FOR A MANDATORY DISCONNECTION FROM THE COMPANY SYSTEM AT V > 1.2 pu. RIDE-THROUGH REQUIREMENTS FOR OTHER SYSTEMS WILL BE DETERMINED IN THE IRS.]**

1.00 pu < V  $\leq$  1.10 pu      The Facility remains connected to the Company System.

1.10 pu < V  $\leq$  1.15 pu      The Facility remains connected to the Company System and in continuous operation no less than 30 seconds; the duration of the event is measured from the point at which the voltage increases at or above 1.1 pu and ends when voltage is at or below 1.1 pu.

V > 1.15 pu      The Facility remains connected to the Company System and in continuous operation for as long as possible as allowed by the equipment operational limitations.

Protective Overvoltage Relaying (59) shall be set to alarm only to meet the above ride-through requirements, and shall not initiate a disconnect from the Company System unless Seller reasonably determines based upon Good Engineering and

Operating Practices that the Facility's equipment is at risk of damage. This is necessary in order to coordinate with the existing Company System.

**(g) Transient Stability Ride-Through.** The Facility shall be designed such that the transient stability of Company System is maintained for normally cleared and secondarily cleared faults. The Facility will be required to remain connected through anticipated rates of change of frequency **[TO BE PROVIDED UPON COMPLETION OF IRS]**.

**(h) Reserved.**

**(i) Underfrequency Ride-Through.** The Facility shall meet the following underfrequency ride-through requirements during an underfrequency disturbance, and export of power shall continue with output adjusted as appropriate for Facility droop response consistent with **Section 1(g)(xi)** (Active Power – Frequency Response (DROOP)), **Section 1(g)(xii)** (Dynamic Active Power – Frequency Performance), and **[FOR FACILITIES WITH STORAGE] Section 1(g)(xiii)** (Alternate Active Power / Frequency Response Modes) of this **Attachment B** (Facility Owned by Seller) ("f" is the Company System frequency at the Point of Interconnection):

$57.0\text{ Hz} \leq f \leq 60.0\text{ Hz}$       The Facility remains connected to the Company System and in continuous operation.

$56.0\text{ Hz} \leq f \leq 57.0\text{ Hz}$       The Facility remains connected to the Company System and in continuous operation for at least six (6) seconds per event. The duration of the event is from the point at which the frequency is below 57 Hz and ends when the frequency is at or above 57 Hz. The Facility may initiate an alarm if frequency remains in this range for more than six (6) seconds.

$f < 56.0\text{ Hz}$       The Facility remains connected to the Company System and in continuous operation for the duration allowed by the equipment operational limitations. The Facility may initiate an alarm immediately.

Protective Underfrequency Relaying (81U) shall be set to alarm only to meet the above ride-through requirements, and shall not initiate a disconnect from the Company System unless Seller reasonably determines based upon Good Engineering and Operating Practices that the Facility's equipment is at risk of damage. This is necessary in order to coordinate with the existing Company System.

Any tripping on calculated frequency should be based on accurately calculated and filtered frequency measurement over a time frame of minimum six cycles, or other period as specified by the Company, and should not use an instantaneously calculated value.

**(j) Overfrequency Ride-Through.** The Facility will behave as specified below for overfrequency conditions, and export of power shall continue with output adjusted as appropriate for Facility droop response consistent with **Section 1(g)(xi)**



(Active Power – Frequency Response (DROOP)), **Section 1(g)(xii)** (Dynamic Active Power – Frequency Performance), and **[FOR FACILITIES WITH STORAGE] Section 1(g)(xiii)** (Alternate Active Power / Frequency Response Modes) (“f” is the Company System frequency at the Point of Interconnection):

$60.0\text{Hz} \leq f \leq 61.5\text{Hz}$	The Facility remains connected to the Company System and in continuous operation.
$61.5\text{Hz} < f \leq 63.0\text{Hz}$	The Facility remains connected to the Company System for at least ten (10) seconds. After ten seconds the Facility may initiate an alarm and the Facility remains connected and producing power for the duration allowed by the equipment operational limitations. The duration of condition is from the point at which the frequency is above 61.5 Hz and ends when the frequency is at or below 61.5 Hz.
$f > 63.0\text{Hz}$	The Facility remains connected to the Company System for the duration allowed by the equipment operational limitations. The Facility may initiate an alarm immediately.

Protective Overfrequency Relaying (81O) shall be set to alarm only to meet the above ride-through requirements, and shall not initiate a disconnect from the Company System unless Seller reasonably determines based upon Good Engineering and Operating Practices that the Facility’s equipment is at risk of damage. This is necessary in order to coordinate with the existing Company System.

Any tripping on calculated frequency should be based on accurately calculated and filtered frequency measurement over a time frame of minimum six cycles, or other period as specified by the Company, and should not use an instantaneously calculated value.

**(k) Successive Faults.** If the resource necessitates tripping to protect from the cumulative effects of those successive faults, in a period of time to ensure safety and equipment integrity, the constraint and time periods should be provided for inclusion in the interconnection study. For all cases, at a minimum, the ride-through requirements shall be met for two ride-through events within two seconds to allow for the Company’s transmission automatic reclosing attempt. **[Note - this requirement may be modified based on the results of the IRS.]**

**(l) Rate of Change of Frequency (“ROCOF”).** The inverter-based resources in the Facility shall not use rate-of-change-of-frequency protection unless an equipment limitation exists that requires the inverter to trip on high ROCOF. Any ROCOF tripping must be approved by Company.

**(m) Phase Angle Shift Ride-Through.** The Facility equipment shall ride through phase angle shift of up to ( ) **[Note – requirements will depend on Facility]**. Inverter phase lock loop (PLL) loss of synchronism shall not cause the inverter to trip or enter momentary cessation within the voltage and frequency ride-

through region. Inverters must be capable of riding through temporary loss of synchronism, and regain synchronism, without causing a trip or momentary cessation of the resource.

**(n) DC Protection.** If the Facility requires DC reverse current protection, such protection must be coordinated with the inverter equipment module ratings and set to operate for short circuits on the DC side. DC reverse current protection shall not operate for transient overvoltage or for AC-side faults.

**(o) Voltage Flicker.** Any voltage flicker on the Company System caused by the Facility shall not exceed the limits stated in IEEE Standard 1453-2011, or latest version “Recommended Practice – Adoption of IEC 61000-4-15:2010, Electromagnetic compatibility (EMC) – Testing and measurement techniques – Flickermeter – Functional and design specifications.”

**(p) Harmonics.** Harmonic distortion at the Point of Interconnection caused by the Facility shall not exceed the limits stated in IEEE Standard 519-1992, or latest version “Recommended Practices and Requirements for Harmonic Control in Electrical Power Systems.” Seller shall be responsible for the installation of any necessary controls or hardware to limit the voltage and current harmonics generated from the Facility to defined levels.

**(q) Grid Forming (“GFM”) Capabilities.** GFM control sets an internal voltage waveform reference such that an inverter with the GFM control shall be able to synchronize with the grid and regulate active and reactive power generation appropriately, regardless of the grid’s strength, or operate independently of other generation. An inverter with GFM control shall immediately respond to grid disturbances to support stability of the grid and maintain its own control stability during the system disturbance.

Seller Facility inverters shall be designed with GFM control and capable of operating in GFM mode supporting system operation under normal and emergency conditions without relying on the characteristics of synchronous machines. While in GFM mode, the inverters will support grid operation, consistent with tariff requirements, as a continuous ac voltage source during normal and transient conditions (as long as no limits are reached within the inverter) and the ability to synchronize to other voltage sources and operate autonomously if a grid reference is unavailable, and should be able to share active and reactive power burden with other voltage sources without impacts on system stability.

Seller should provide information to the Company regarding control design, capabilities, characteristics, etc. of the GFM control of the Facility for Company review and approval. Additional specifics of the GFM control may be defined during the IRS.

**Specifically, the GFM controls shall have the following functions and characteristics:**

- Allow Seller Facility to operate in stable manner on low system strength grids (e.g. low short circuit ratio, low inertia, inertia-less system, etc.)

- Sets an internal voltage waveform reference and is able to synchronize with the grid or operate independently of other generation.
- Responds to system condition changes (i.e. frequency change and voltage change) beyond the control deadband in a timely manner by contributing towards the subsequent recovery of system frequency and voltage to the pre-disturbance value, assuming energy and power margins are available.
- Provide damping control function which damps oscillation within the interconnection and other adverse interactions among GFM and Grid Following (“GFL”) Inverter Based Resources and other power electronic devices on the grid.
- Upon the loss of the last synchronous machine in the power system, GFM will have the ability to operate autonomously if a grid reference is unavailable and be able to share active and reactive power burden with other voltage sources without impacts on system stability.
- Ability to transition from an electrical island to a grid-connect configuration without an impact to system stability.
- Provide active low-order harmonics cancellation (as applicable).
- Provide black-start capability (as applicable).

Seller shall operate the Facility in GFM mode only as directed by the Company System Operator, in its sole discretion. The Facility shall be required to communicate to the Company its parameters and settings pertaining to GFM mode.

The grid forming control block diagram shall be submitted to the Company for review. The design shall be approved in writing by the Company and implemented by the Seller prior to control system testing. This shall include initial settings for tunable controls parameters based on modeling. The initial control parameters may be modified by Seller on Company request; based on field data and performance, subsequent system resource changes, etc. to achieve acceptable system stability.

**(r) Black-Start Capability.** The Facility shall have the capability to self-start, and also energize the islanded transformers and loads in a single breaker closure without outside assistance. Further, inverter-based resources shall ensure they have sufficient energy storage to maintain power injection to the grid during system restoration (i.e., have power available when and if called upon). The capability of the Project to energize transformers and loads is only required within the limits of the Rated Active Power Capacity and Rated Energy Capacity. Seller is responsible for determining the required minimum capacities and appropriate controls of the Facility to facilitate black start energization.

**(s) Provision of Synthetic Inertia. [TO BE DETERMINED BASED ON IRS.]**

(t) **Generator Step-Up Transformer Impedance.** The generator step-up transformer impedance shall be between [ ] percent and [ ] percent, inclusive, on transformer OA rating. **[NOTE: THESE VALUES WILL BE BASED ON THE RESULTS OF THE IRS.]**

(u) **Control Systems and Auxiliary Equipment.** The power source for control systems and auxiliary equipment required for normal operation of the Facility shall be designed to be immune from system transients in accordance with the Public Utilities Commission of the State of Hawaii tariff for Hawaii Electric Light Company, Inc. Rule No. 2, Character of Service (Revised Sheet No. 5, effective Oct. 20, 1991) and Section 3.2(A)(6) (Facility Protection and Control Equipment) to meet the performance during under/overvoltage and under/overfrequency conditions pursuant to **Section 3(e)** (Undervoltage Ride-Through), **Section 3(f)** (Over Voltage Ride-Through), **Section 3(i)** (Underfrequency Ride-Through) and **Section 3(j)** (Overfrequency Ride-Through) of this **Attachment B** (Facility Owned by Seller).

(v) **Frequency Response.** Seller shall comply with the requirements of **Section 1(g)(xi)** (Frequency Response Mode), and **Section 1(g)(xii)** (Dynamic Active Power – Frequency Performance) of this **Attachment B** (Facility Owned by Seller). (w)

**Back-up Power.** The Facility shall have the capability to supply power to maintain service continuity and grid resilience to the microgrid islanded area in the event of a planned grid connection outage, at the direction of Company without any observable power quality issues or momentary outages. Momentary outages are acceptable for unplanned grid connection outages, prior to the BESS Black Start being initiated.

#### **4. Maintenance of Seller-Owned Interconnection Facilities.**

(a) Seller must address any Disconnection Event (as defined below) according to the requirements of this **Section 4** (Maintenance of Seller-Owned Interconnection Facilities) of **Attachment B** (Facility Owned by Seller). For the purposes of this **Section 4** (Maintenance of Seller-Owned Interconnection Facilities), a “**Disconnection Event**” is the removal of any Energy Storage Inverter Unit or more from Company System and/or disconnection of the Facility from the Company’s System (i) that is not the result of Company dispatch, frequency droop response, or isolation of the Facility resulting from designed protection fault clearing, and (ii) for which Company does not issue for such disconnection the written notice for failure to meet operational and performance requirements as set forth in **Section 1(j)** (Demonstration of Facility) of this **Attachment B** (Facility Owned by Seller). Company’s election to exercise its rights under **Section 1(j)** (Demonstration of Facility) shall not relieve Seller of its obligation to comply with the requirements of this **Section 4** (Maintenance of Seller-Owned Interconnection Facilities) for any future Disconnection Event during the pendency of such election or thereafter.

(b) For every Disconnection Event from the Company System, Seller shall investigate the cause. Within three (3) Business Days of the Disconnection Event, Seller shall provide, in writing to Company, an incident report that summarizes the sequence of events and probable cause of the Disconnection Event.

(c) Within forty-five (45) Days of a Disconnection Event, Seller shall provide,

in writing to Company, Seller's findings, data relied upon for such findings, and proposed actions to prevent reoccurrence of a Disconnection Event ("**Proposed Actions**"). Company may assist Seller in determining the causes of and recommendations to remedy or prevent a Disconnection Event ("**Company's Recommendations**"). Seller shall implement such Proposed Actions (as modified to incorporate the Company's Recommendations, if any) and Company's Recommendations (if any) in accordance with the time period agreed to by the Parties.

(d) In the event Seller and Company disagree as to (i) whether a Disconnection Event occurred, (ii) the sequence of events and/or probable cause of the Disconnection Event, (iii) the Proposed Actions, (iv) Company's Recommendations, and/or (v) the time period to implement the Proposed Actions and/or Company's Recommendations, then the Parties shall follow the procedure set forth in **Section 5** (Expedited Dispute Resolution) of this **Attachment B** (Facility Owned by Seller).

(e) Upon the fourth (4th) Disconnection Event (and each subsequent Disconnection Event) within any Contract Year, the Parties shall follow the procedures set forth in **Section 4(a)** and **Section 4(d)** of **Attachment B** (Facility Owned by Seller), to the extent applicable. If after following the procedures set forth in this **Section 4** (Maintenance of Seller-Owned Interconnection Facilities) of **Attachment B** (Facility Owned by Seller), Seller and Company continue to have a disagreement as to (i) the probable cause of the Disconnection Event, (ii) the Proposed Actions, (iii) the Company's Recommendations, and/or (iv) the time period to implement the Proposed Actions and/or the Company's Recommendations, then the Parties shall commission a study to be performed by a qualified independent third-party consultant ("**Qualified Consultant**") chosen from the Qualified Independent Third-Party Consultants List ("**Consultants List**") attached to the Agreement as **Attachment D** (Consultants List). Such study shall review the design of, review the operating and maintenance procedures dealing with, recommend modifications to, and determine the type of maintenance that should be performed on Seller-Owned Interconnection Facilities ("**Study**"). Seller and Company shall each pay for one-half of the total cost of the Study. The Study shall be completed within ninety (90) Days from such fourth Disconnection Event (and each subsequent Disconnection Event) within any Contract Year, unless the Qualified Consultant determines the Study cannot reasonably be completed within ninety (90) Days, in which case, such longer period of time as the Qualified Consultant determines is necessary to complete the Study shall apply. The Qualified Consultant shall send the Study to Company and Seller. Seller (and/or its third-party consultants and contractors), at Seller's expense, shall change the design of, change the operating and maintenance procedures dealing with, implement modifications to, and/or perform the maintenance on Seller-Owned Interconnection Facilities recommended by the Study. Such design changes, operating and maintenance procedure changes, modifications, and/or maintenance shall be completed no later than forty-five (45) Days from the Day the completed Study is issued by the Qualified Consultant, unless such design changes, operating and maintenance procedure changes, modifications, and/or maintenance cannot reasonably be completed within forty-five (45) Days, in which case, Seller shall complete the foregoing within such longer commercially reasonable period of time agreed to by the Parties in writing. Company shall have the right to derate the Facility to a level that maintains reliable operations in accordance with Good Engineering and Operating Practices, and the Facility shall be deemed to be in Seller-Attributable

Unavailability status, until the study has been completed and the study's recommendations have been implemented by Seller to Company's reasonable satisfaction. Nothing in this provision shall affect Company's right of Company Dispatch/Charge as provided for in this Agreement.

(f) The Consultants List attached hereto as **Attachment D** (Consultants List) contains the names of engineering firms which both Parties agree are fully qualified to perform the Study. At any time, except when a Study is being conducted, either Party may remove a particular consultant from the Consultants List by giving written notice of such removal to the other Party. However, neither Party may remove a name or names from the Consultants List without approval of the other Party if such removal would leave the list without any names. Intended deletions shall be effective upon receipt of notice by the other Party, provided that such deletions do not leave the Consultants List without any names. Proposed additions to the Consultants List shall automatically become effective thirty (30) Days after notice is received by the other Party unless written objection is made by such other Party within said thirty (30) Day period. By mutual agreement between the Parties, a new name or names may be added to the Consultants List at any time.

**5. Expedited Dispute Resolution.** If there is a disagreement between Company and Seller regarding (a) whether a Disconnection Event occurred, (b) the sequence of events and/or probable cause of the Disconnection Event, (c) the Proposed Actions, (d) the Company's Recommendations, and (e) the time period to implement the Proposed Actions and/or the Company's Recommendations, then authorized representatives from Company and Seller, having full authority to settle the disagreement, shall meet in Hawai'i (or by telephone conference) and attempt in good faith to settle the disagreement. Unless otherwise agreed in writing by the Parties, the Parties shall devote no more than five (5) Business Days to settle the disagreement in good faith. In the event the Parties are unable to settle the disagreement after the expiration of the time period, then such disagreement shall constitute a Dispute for which either Party may pursue the dispute resolution procedure set forth in **Section 26.2** (Dispute Resolution Procedures) of this Agreement.

**6. Modeling.**

(a) **Seller's Obligation to Provide Models.** Within thirty (30) Days of Company's written request, but no later than the Commercial Operations Date, Seller shall provide detailed data regarding the design and location of the Facility, in a form reasonably satisfactory to Company, to allow the modeling of the inverters and any other equipment within the Facility identified in the IRS which utilizes Source Code (such as energy storage system, STATCOM or DVAR equipment), including, but not limited to, integrated and validated power flow and transient stability models (such as PSS/E models), a short circuit model (such as an ASPEN model), and an electro-magnetic transient model (such as a PSCAD model) of the inverters and any additional equipment identified in the IRS as set forth above, applied assumptions, and pertinent data sets (each a "**Required Model**" and collectively, the "**Required Models**"). Thereafter, during the Term, Seller shall provide working updates of any Required Model within thirty (30) Days of (i) Company's written request, or (ii) Seller obtaining knowledge or notice that any Required Model has been modified, updated or superseded by the Source Code Owner.

**(b) Escrow Establishment.** If, pursuant to **Section 6(a)** (Seller's Obligation to Provide Models) of this **Attachment B** (Facility Owned by Seller), the Required Models are provided to the Company in a form other than Source Code, Seller shall arrange for and ensure that the Source Code for the relevant Required Model is deposited into the Source Code Escrow as set forth below in **Section 6(b)(i)** (Source Code Escrow) of this **Attachment B** (Facility Owned by Seller) no later than the time periods set forth in **Section 6(a)** (Seller's Obligation to Provide Models) of this **Attachment B** (Facility Owned by Seller) for delivery of the Required Models. Seller shall be responsible for all costs associated with establishing and maintaining the Source Code Escrow. If, however, Seller is unable to deposit the required Source Code into the Source Code Escrow within the time periods set forth in **Section 6(a)** (Seller's Obligation to Provide Models), Seller shall, no later than such time periods, instead establish a monetary escrow as set forth below in **Section 6(b)(ii)** (Monetary Escrow) of this **Attachment B** (Facility Owned by Seller).

**(i) Source Code Escrow.**

**(A) Establishment of Source Code Escrow.** If the Required Models are not provided to the Company in the form of Source Code pursuant to **Section 6(a)** of this **Attachment B** (Facility Owned by Seller), Seller shall: (1) arrange for and ensure the deposit of a copy of the current version of the Source Code and relevant documentation for all Required Models with the Source Code Escrow Agent under the terms and conditions of the Source Code Escrow Agreement, and (2) arrange for and ensure the update of the deposited Source Code and relevant documentation for Major Releases and Minor Releases of the Required Models as soon as reasonably possible after they are made generally available.

**(B) Release Conditions.** Company shall have the right to obtain from the Source Code Escrow Agent one copy of the escrowed Source Code for the Required Models, under the following conditions upon Company's request:

**(1)** A receiver, trustee, or similar officer is appointed, pursuant to federal, state or applicable foreign law, for the Source Code Owner;

**(2)** Any voluntary or involuntary petition or proceeding is instituted, under (a) U.S. bankruptcy laws or (b) any other bankruptcy, insolvency or similar proceeding outside of the United States, by or against the Source Code Owner;

**(3)** Failure of the Source Code Owner to function as a going concern or operate in the ordinary course; or

**(4)** Seller and the Source Code Owner fail to provide to Company the Required Models or updated Required Models, or, alternatively, fail to issue a Source Code LC, within the time periods set forth in **Section 6(a)** (Seller's Obligation to Provide Models) of this **Attachment B** (Facility Owned by Seller), Company gives written notice of such failure to Seller and the Source Code Owner, and Seller and Source Code Owner fail to remedy such breach within five (5) Days following receipt of such notice.

**(C) Remedies.** If Company has the right to obtain from the Source Code Escrow Agent one copy of the escrowed Source Code for the Required Models pursuant to **Section 6(b)(i)(B)** (Release Conditions) of **Attachment B** (Facility Owned by Seller), and Company finds that Seller failed to arrange for and ensure the update the Source Code Escrow with the modified and/or updated Source Code and relevant documentation for Major Releases and Minor Releases of the Required Models as provided in **Section 6(b)(i)** (Establishment of Source Code Escrow) of **Attachment B** (Facility Owned by Seller) or that the Source Code for the Required Models is incomplete or otherwise unusable, Seller shall be liable to Company for liquidated damages in the amount of \$500 per Day for each Day Seller fails to provide such Source Code to Company or such update to the Source Code to Company from the date such Major Release or Minor Release was first made available by the Source Code Owner to customers of the Source Code Owner. Failure to provide the updated Source Code of the Required Models within 30 Days' notice from Company of a breach of **Section 6(b)(i)(A)** (Establishment of Source Code Escrow) of **Attachment B** (Facility Owned by Seller); provided, that Seller has also failed to provide a satisfactory Source Code LC as set forth in **Section 6(b)(ii)** (Source Code Security) of this **Attachment B** (Facility Owned by Seller) shall constitute an Event of Default pursuant to **Section 6.2(f)** under the Agreement.

**(D) Certification.** The Source Code Escrow Agent shall release the Source Code of the Required Models to Company upon receipt of a signed statement by a representative of Company that reads substantially as follows:

The undersigned hereby certifies that (i) I am duly authorized to execute this document on behalf of Hawai'i Electric Light Company, Inc. ("**Hawai'i Electric Light**"), and (ii) Hawai'i Electric Light is entitled to a copy of the Source Code of the Required Models Pursuant to **Section 6(b)(i)(B)** (Release Conditions) of **Attachment B** (Facility Owned by Seller) of the Energy Storage Services Agreement dated as of \_\_\_\_\_, between \_\_\_\_\_, and Hawai'i Electric Light.

**(E) Authorized Use.** If Company becomes entitled to a release of the Source Code of the Required Models from escrow, Company may thereafter correct, modify, update and enhance the Required Models for the sole purpose of providing itself the support and maintenance it otherwise would have been entitled to if it had been provided the Required Models by Seller under **Section 6(a)** (Seller's Obligation to Provide Models) of this **Attachment B** (Facility Owned by Seller) (the "**Source Code Authorized Use**").

**(F) Confidentiality Obligations.** Company shall keep the Source Code of the Required Models confidential pursuant to the confidentiality obligations of the Source Code Escrow Agreement. Company shall restrict access to the Source Code of the Required Models to those employees, independent contractors and consultants of Company who have agreed in writing to be bound by confidentiality and use obligations consistent with those specified in the Escrow Agreement, and who have a need to access the Source Code of the Required Models on behalf of Company to carry out their duties for the Source Code Authorized Use. Promptly upon Seller's



request, Company shall provide Seller with the names and contact information of all individuals who have accessed the Source Code of the Required Models, and shall take all reasonable actions required to recover any such Source Code in the event of loss or misappropriation, or to otherwise prevent their unauthorized disclosure or use.

**(ii) Source Code Security.**

**(A) Establishment of Source Code Security.** If the Required Models and their relevant Source Code are not provided to the Company in the form of Source Code pursuant to **Section 6(a)** (Seller's Obligation to Provide Models) of this **Attachment B** (Facility Owned by Seller) and if the Seller is unable to arrange for and ensure the deposit of the Source Code into the Source Code Escrow established for the benefit of the Company pursuant to **Section 6(b)(i)** (Source Code Escrow) of this **Attachment B** (Facility Owned by Seller) then, no later than the time periods set forth in **Section 6(a)** (Seller's Obligation to Provide Models) of this **Attachment B** (Facility Owned by Seller) for delivery of the Required Models and Source Code, Seller shall provide an irrevocable standby letter of credit (the "**Source Code LC**") with no documentation requirement in the amount of Two Hundred Fifty Thousand Dollars (\$250,000) per Required Model (and its relevant Source Code) substantially in the form attached to this Agreement as **Attachment M** (Form of Letter of Credit) from a bank chartered in the United States with a credit rating of "A-" or better from Standard & Poor's or A3 or better from Moody's. Such letter of credit shall be issued for a minimum term of one (1) year. Furthermore, at the end of each year the security shall be renewed for an additional one (1) year term so that at the time of such renewal, the remaining term of any such security shall not be less than one (1) year. The letter of credit shall include a provision for at least thirty (30) Days' advance notice to Company of any expiration or earlier termination of the letter of credit so as to allow Company sufficient time to exercise its rights under said security if Seller fails to extend or replace the security. In all cases, the reasonable costs and expenses of establishing, renewing, substituting, canceling, increasing, reducing, or otherwise administering the letter of credit shall be borne by Seller.

**(B) Release Conditions.** Company shall have the right to draw on the letter of credit the funds necessary to develop and recreate the Required Model or Required Models upon Company's request if Seller fails to provide the Company the Required Models or updated Required Models within the time periods set forth in **Section 6(a)** (Seller's Obligation to Provide Models) or **Section 6(b)(i)(C)** (Remedies) of this **Attachment B** (Facility Owned by Seller), Company gives written notice of such failure to Seller, and Seller fails to remedy such breach within five (5) Days following receipt of such notice for a breach under **Section 6(a)** (Seller's Obligation to Provide Models), or within thirty (30) Days following receipt of such notice for a breach under **Section 6(b)(i)(C)** (Remedies).

**(C) Extend Letter of Credit.** If the letter of credit is not renewed or extended no later than thirty (30) Days prior to its expiration or earlier termination, Company shall have the right to draw immediately upon the full amount of the letter of credit and to place the proceeds of such draw (the "**Proceeds**"), at Seller's cost, in an escrow account in accordance with **Section 6(b)(ii)(D)** (Proceeds Escrow), until and unless Seller provides a substitute form of letter of credit meeting

the requirements of this **Section 6(b)(ii)** (Source Code Security) of this **Attachment B** (Facility Owned by Seller).

**(D) Proceeds Escrow.** If Company draws on the letter of credit pursuant to **Section 6(b)(ii)(C)** (Extend Letter of Credit) of this **Attachment B** (Facility Owned by Seller), Company shall, in order to avoid comingling the Proceeds, have the right but not the obligation to place the Proceeds in an escrow account as provided in this **Section 6(b)(ii)(D)** (Proceeds Escrow) of this **Attachment B** (Facility Owned by Seller) with a reputable escrow agent acceptable to Company (“**Proceeds Escrow Agent**”), subject to an escrow agreement acceptable to Company (“**Proceeds Escrow Agreement**”). Without limitation to the generality of the foregoing, a federally-insured bank shall be deemed to be a “reputable escrow agent.” Company shall have the right to apply the Proceeds as necessary to recover amounts Company is owed pursuant to this **Section 6** (Modeling) of this **Attachment B** (Facility Owned by Seller). To that end, the Proceeds Escrow Agreement governing such escrow account shall give Company the sole authority to draw from the account. Seller shall not be a party to such Proceeds Escrow Agreement and shall have no rights to the Proceeds. Upon full satisfaction of Seller’s obligations under **Section 6** (Modeling) of this **Attachment B** (Facility Owned by Seller), Company shall instruct the Proceeds Escrow Agent to remit to the bank that issued the letter of credit that was the source of the Proceeds the remaining balance (if any) of the Proceeds. If there is more than one escrow account with Proceeds, Company may, in its sole discretion, draw on such accounts in any sequence Company may select. Any failure to draw upon the Proceeds for any damages or other amounts due Company shall not prejudice Company’s rights to recover such damages or amounts in any other manner.

**(E) Seller’s Obligation.** If the letter of credit is not sufficient to cover Company’s associated consultant fees, costs and expenses to develop and recreate the Required Models, Seller shall pay to Company the difference within ten (10) Days of Company’s written notice to Seller.

**(F) Model Verification.** Seller shall work with the Company to validate the new Required Models developed by or on behalf of Company within sixty (60) Days of receiving such new Required Models. Seller shall also arrange for and ensure that Company may obtain new Required Models directly from the Source Code Owner in the event that Seller ceases to operate as a going concern or is subject to voluntary or involuntary bankruptcy and is unable or unwilling to obtain the new Required Models from the Source Code Owner.

**(G) Certification.** The terms of the letter of credit shall provide for a release of the funds, or in the event the funds have been placed into a Proceeds Escrow, the Proceeds Escrow Agent shall release the necessary funds to Company upon receipt of a signed statement by a representative of Company that reads substantially as follows:

The undersigned hereby certifies that (i) I am duly authorized to execute this document on behalf of Hawai‘i Electric Light Company, Inc. (“**Hawai‘i Electric Light**”), and (ii) Hawai‘i Electric Light is entitled to \$\_\_\_\_\_ pursuant to **Section 6(b)(ii)(B)** (Release Conditions) of

**Attachment B** (Facility Owned by Seller) of the Energy Storage Services Agreement dated as of \_\_\_\_\_, between \_\_\_\_\_, and Hawai'i Electric Light.

**(H) Authorized Use.** If Company becomes entitled to a draw of funds from the Source Code Security or a release of funds from the Proceeds Escrow, Company may thereafter use such funds to develop, recreate, correct, modify, update and enhance the Required Models for the sole purpose of providing itself the support and maintenance it otherwise would have been entitled to if it had been provided the Required Models by Seller under **Section 6(a)** (Seller's Obligation to Provide Models) of this **Attachment B** (Facility Owned by Seller).

**(iii) Supplementary Agreement.** The parties stipulate and agree that the escrow provisions in this **Section 6(b)** (Escrow Establishment) of **Attachment B** (Facility Owned by Seller), and the Source Code Escrow Agreement and Proceeds Escrow Agreement are "supplementary agreements" as contemplated in 11 U.S.C. § 365(n)(1)(B). In any voluntary or involuntary bankruptcy proceeding involving Seller, failure by Company to assert its rights to "retain its rights" to the intellectual property encompassed by the Source Code or the funds in the Proceeds Escrow, pursuant to 11 U.S.C. § 365(n)(1)(B), under an executory contract rejected in a bankruptcy proceeding, shall not be construed as an election to terminate the contract by Company under 11 U.S.C. § 365(n)(1)(A).

## **7. Testing Requirements.**

**(a) Testing Requirements.** Once the Control System Acceptance Test has been successfully passed, Seller shall not replace and/or change the configuration of the Facility Control, inverter control settings and/or ancillary device controls, without prior written notice to Company. In the event of any such replacement and/or change, the relevant test(s) of the Control System Acceptance Test shall be redone and must be successfully passed before the replacement or altered equipment is allowed to be placed in normal operations. In the event that Company reasonably determines that such replacement and/or change of controls makes it inadvisable for the Facility to continue in normal operations without a further Control Systems Acceptance Test, the Facility shall be deemed to be in Seller-Attributable Unavailability status until the new relevant tests of the Control System Acceptance Test have been successfully passed.

**(b) Periodic Testing.** Seller shall coordinate periodic testing of the Facility with Company to ensure that the Facility is meeting the performance standards specified under this Agreement.

## **8. Reserved.**

## **9. Technology Specific Requirements.**

**(a) Reserved.**

**(b) Reserved.**

**(c) Inverter Systems.**

**(i)** Direct current generators and non-power (i.e., other than 60 Hertz) alternating current generators can only be installed in parallel with the Company System using a non-islanding synchronous inverter unless alternative designs are approved by Company. The design shall comply with the requirements of IEEE Std 1547-2018 (or latest version), except as described in **Section 3** (Performance Standards) of this **Attachment B** (Facility Owned by Seller).

**(ii)** Self-commutated inverters of the Company-interactive type shall synchronize to the Company System. Line-commutated, thyristor-based inverters are not recommended and will require additional technical study to determine harmonic and reactive power requirements. All interconnected inverter systems shall comply with the harmonic current limits of IEEE Std 519-1992 (or latest version).

**(d) Battery Energy Storage System.** The operating parameters of the BESS shall be as follows:

**(i)** The BESS will be capable of retaining the Rated Energy Capacity for extended periods without charging or discharging to support planned and unplanned microgrid islanded operation.

**(ii)** The BESS will not be required to discharge more energy than available relative to the available State of Charge.

**(iii)** The cumulative energy discharged by the Facility measured between January 1 at 12:00 a.m. to December 31 at 11:59:59 p.m. in each calendar year (the “**Maximum Annual Energy Throughput**”) is not intended to exceed [3960 MWh].

## **EXHIBIT B-1**

### **MODELING REQUIREMENTS**

**1. Steady State and Dynamic Model Requirements and As-built Data to be provided by Seller.** The expected steady state power flow and dynamic models will be provided by the Seller during the interconnection study process in the format compatible with the analytical tools used by Company. Depending upon Facility design, different representations may be required for steady state and dynamic simulations. Seller will work with Company to derive a complex equivalent model if it is required to meet interconnection study needs. The as-built data and models will be provided by Seller immediately upon commissioning with sufficient information to demonstrate that the as-built parameters match the model. Any changes to plant settings that affect its response and impact to the Company System are required to be studied prior to those changes taking effect. The modeling will include all necessary control settings such that the correct capabilities, flags, and settings can be represented in a base case. Where such parameters are settable according to this Agreement, the initial models will be configured with parameters mutually agreed with Company for the interconnection study analysis. This includes, but is not limited to:

- Plant Type: A description of the resource type (e.g., storage, solar PV or wind power resource) used as a flag to ensure that the inverter-based resource is accurately represented in the base case, where applicable.
- Active and Reactive Capability: The overall plant “composite capability curve” shall be provided by Seller for performance purposes. That same curve will be used for accurately modeling the P-Q capability in power flow studies.
- Plant-Level Voltage Control Settings: Information on the plant voltage control mode to ensure correct voltage control flags and set points are set accordingly in the software tools.
- The voltage control set point at the POI is provided by the Company. Seller shall provide a description of the coordination of any plant-level shunt compensation (static or dynamic) to ensure it can be accurately represented in the power flow base case.

The models provided by Seller should accurately reflect the contractual requirements established under this Agreement.

**2. Positive Sequence Stability Modeling.** Seller shall provide a positive sequence stability model representation which provides sufficient detailed modeling for necessary reliability studies, as specified by Company. **[Note – language to be revised based on proposed Facility.]** For example, the following are typical requirements for plants with inverter equipment:

- Inverter-Level Controller Model: This represents the overall control of the inverter as an energy or generating resource.

- Electrical Control Model: This represents the detailed electrical controls of the resource, including large disturbance behavior.
- Plant-Level Controller Model: This represents control of multiple individual inverters and/or generators within the plant

**3. Short Circuit Modeling.** Seller will provide appropriate and accurate models to Company to support short circuit studies. **[Company to specify requirements based on specific Facility]**

**4. Electromagnetic Transient Modeling.** Company will require an electromagnetic transient (“**EMT**”) model for the Facility. Seller shall provide Company with an EMT model for the IRS and an updated EMT model after the Facility has been commissioned. These models are in addition to the positive sequence stability models required for interconnection-wide modeling purposes. In addition, Seller shall provide Company with evidence that the expected (and commissioned) EMT model reasonably matches the positive sequence dynamic models provided. This should include a benchmarking report provided by the inverter OEM.

**EXHIBIT B-2**  
**CAPABILITY CURVE(S)**

**ATTACHMENT C  
RESERVED**



**ATTACHMENT D**  
**CONSULTANTS LIST**

**ATTACHMENT E**  
**SINGLE-LINE DRAWING AND INTERFACE BLOCK DIAGRAM**

(To be attached pursuant to **Section 1(a)** of **Attachment B**)

**ATTACHMENT F**  
**RELAY LIST AND TRIP SCHEME**

(To be attached pursuant to **Section 1(a)** of **Attachment B**)

**[This Attachment will be revised to reflect the results of the IRS]**

## **ATTACHMENT G**

### **COMPANY-OWNED INTERCONNECTION FACILITIES**

#### **1. Description of Company-Owned Interconnection Facilities.**

**(a) General.** Company shall furnish or construct, own, operate and maintain all Interconnection Facilities required to interconnect Company System with Facility at 34,500 volts, up to the Point of Interconnection (collectively, the “**Company-Owned Interconnection Facilities**”). Such Company-Owned Interconnection Facilities include **[ADD LIST OF COMPANY-OWNED INTERCONNECTION FACILITIES THAT ARE REQUIRED PURSUANT TO THE RESULTS OF THE IRS. THE FOLLOWING IS AN EXAMPLE OF THE TYPES OF FACILITIES THAT COULD BE LISTED]**:

**(i) [Line extension];**

**(ii)** A manually operated, lockable, group operated switch located on a pole prior to the Facility switching station. Company will install a \_\_\_\_ kV drop into Seller-provided deadend structure;

**(iii)** Substation additions and/or modifications of Company’s existing structures as necessary, including, but not be limited to, protective relaying and setting changes;

**(iv)** Supervisory control and communications equipment (including but not limited to, SCADA/Telemetry and Control, microwave, satellite, dedicated phone line(s) and/or any other acceptable communications means (determined by Company), fiber optics, copper cabling, installation of batteries and charger system, etc.);

**(v)** Revenue Metering Package, as provided in **Section 9.1** (Revenue Metering Package; Station Use Metering Equipment); and

**(vi)** Any additional Interconnection Facilities needed to be installed as a result of final determination of Facility switching station site, final design of Facility to enable Company to complete the Interconnection Facilities and be compatible with Good Engineering and Operating Practices.

**(b) Site.** Company shall determine the location and Company access rights of all Company-Owned Interconnection Facilities on the Site. If power sources (120/240 VAC) are required, Seller shall provide such sources, at no expense to Company.

**(c) IRS.** An IRS addressing Facility requirements was completed for the Facility in accordance with the IRS Letter Agreement, and the results have been incorporated in **Attachment B** (Facility Owned by Seller) and this **Attachment G** (Company-Owned Interconnection Facilities) as appropriate.

**2. Support Services By Seller.** Seller shall provide the necessary support for the Company's \_\_\_kV overhead line extension work, which may include, but not limited to:

(a) Furnish surveyed topographical drawing including contour lines of project areas and beyond as needed in State Plane coordinates with overlay of the Facility and Company pole line route(s) indicating pole locations and anchors in CADD format acceptable to Company.

(b) Staking of Company proposed poles and anchors by surveyor.

(c) Graded access roads including gravel if required by Company to provide sufficient vehicle access to Company poles and anchors by Company trucks and cranes.

(d) Graded level pads to provide vehicle working areas around all Company poles and anchors.

(e) Grading of the areas beneath the Company's overhead lines as needed to provide required ground clearance.

(f) Grubbing and clearing of vegetation within Company's easement area or as required.

**3. Acceptance Test Procedures.**

(a) Seller acknowledges that: (i) Company has multiple on-going projects with other developers as well as its own capital improvement projects and on-going system work; (ii) Company has limited resources to provide engineering oversight (such as review of plans) to such projects and to participate in the testing of such projects; (iii) in order for Company to accommodate such oversight and testing, it is necessary for Company to sequentially allocate its resources for each project a year or more in advance; (iv) the result is a queue of such projects that reflects the scheduling commitments of Company's resources to conduct such oversight and to participate in such testing; (v) if a project is behind the schedule on which Company's resources have been scheduled for the oversight of such project, or if a project is not ready for testing at the time Company's resources have been scheduled for the testing of such project, or if a project does not complete testing within the period for which Company's resources have been scheduled for such testing, the progress of projects later in the queue may be adversely affected; (vi) the Test Ready Deadline that is set forth in **Attachment K-1** (Seller's Conditions Precedent and Company Milestones) reflects the scheduling commitment of Company's resources to (A) conduct the oversight necessary to facilitate Seller's achievement of that Test Ready Deadline, (B) commence the Acceptance Test on the Acceptance Testing Milestone Date that is set forth in **Attachment K-1** (Seller's Conditions Precedent and Company Milestones) and (C) thereafter participate in the Control System Acceptance Test; and (vii) in the Company's sole discretion based on its assessment of Company's resources, overall schedule of projects at the time, the Project may lose its place in the queue and may be assigned a new Acceptance Testing Milestone Date for commencement of the Acceptance Test that may be behind the other projects then in the queue if (1) Seller fails to satisfy any of the conditions precedent set forth in **Section 3(b)** of this

**Attachment G** (Company-Owned Interconnection Facilities) within the time period specified therein for the task in question or, if no time period is specified therein, by the Test Ready Deadline, (2) the Seller fails to satisfy any of the Seller's Conditions Precedent set forth in **Attachment K-1** (Seller's Conditions Precedent and Company Milestones) and/or (3) the Acceptance Test is not satisfactorily completed within the time allotted to complete such testing.

**(b)** The Conduct of the Acceptance Test is subject to the satisfaction of the following conditions precedent within the time period specified below for the task in question or, if no time period is specified, by the Test Ready Deadline that is set forth in **Attachment K-1** (Seller's Conditions Precedent and Company Milestones):

**(i)** Final Single-Line Drawing, and notes, has received Company's written consent pursuant to **Section 1(a)(i)** (Single-Line Drawing, Interface Block Diagram, Relay List, Relay Settings and Trip Scheme) of **Attachment B** (Facility Owned by Seller) to this Agreement.

**(ii)** Final Relay List and Trip Scheme have received Company's written consent pursuant to **Section 1(a)(i)** (Single-Line Drawing, Interface Block Diagram, Relay List, Relay Settings and Trip Scheme) of **Attachment B** (Facility Owned by Seller) to this Agreement.

**(iii)** Final Interface Block Diagram has received Company consent pursuant to **Section 1(a)(i)** (Single-Line Drawing, Interface Block Diagram, Relay List, Relay Settings and Trip Scheme) of **Attachment B** (Facility Owned by Seller) to this Agreement.

**(iv)** Final Control System Telemetry and Control List has received Company consent.

**(v)** Final phasor measurement unit (PMU) devices, if applicable, have received Company consent.

**(vi)** Control system design and tunable parameters reviewed and mutually agreed upon as needed to meet the Company requirements in accordance with **Section 3** (Performance Standards) of **Attachment B** (Facility Owned by Seller) to this Agreement.

**(vii)** Agreement on Active Power Control Interface.

**(viii)** No later than fourteen (14) Days prior to commencement of the Acceptance Test:

**(A)** Seller shall have certified to Company that Seller-Owned Interconnection Facilities have been installed and commissioned and such certification has not, prior to the commencement of the Acceptance Test, been subsequently challenged by Company on the basis of onsite observations made by the Company's representatives following the walk-through to be conducted pursuant to **Section 3(c)** of this **Attachment G** (Company-Owned Interconnection Facilities).

**(B)** Seller shall have certified to Company that any Company-Owned Interconnection Facilities built by Seller (and/or its Contractors) have been installed and commissioned and such certification has not, prior to the commencement of the Acceptance Test, been subsequently challenged by Company on the basis of onsite observations made by the Company's representatives following the walk-through to be conducted pursuant to **Section 3(c)** of this **Attachment G** (Company-Owned Interconnection Facilities).

**(ix)** Any Company-Owned Interconnection Facilities not built by or on behalf of Seller have been installed and commissioned.

**(x)** No later than seven (7) Days prior to the commencement of the Acceptance Test, Seller and Company shall have participated in walk-through of fully constructed Interconnection Facilities.

**(xi)** Redlined as-built drawings of the Seller-Owned Interconnection Facilities and any of the Company-Owned Interconnection Facilities built by Seller (and/or its Contractors) shall have been provided to Company.

**(xii)** Continuous power is being supplied to Company's protection and SCADA equipment.

**(xiii)** Not less than four (4) weeks prior to the commencement of the Acceptance Test, the high speed communication lines required under this Agreement have been commissioned and are ready for use for EMS and revenue metering purposes.

**(xiv)** Not less than two (2) weeks prior to the commencement of the Acceptance Test, Seller and Company have participated in an on-Site Acceptance Test coordination meeting.

**(c)** Seller shall provide Company with at least fourteen (14) Days advance written notice of the Acceptance Test, which shall be scheduled during normal business hours on a Business Day (and may take a minimum of thirty (30) Days to complete). No electric energy will be delivered from Seller to Company during this Acceptance Test. No later than thirty (30) Days prior to conducting the Acceptance Test, Company and Seller shall agree on a written protocol setting out the detailed procedure and criteria for passing the Acceptance Test. **Attachment N** (Acceptance Test General Criteria) provides general criteria to be included in the written protocol for the Acceptance Test. At the time that Seller provides its 14-Day notice of the Acceptance Test to Company, Seller shall concurrently schedule a site walk-through of the Facility with Company to occur no later than seven (7) Days prior to the Acceptance Test. Seller's 14-Day notice to Company of the Acceptance Test shall constitute its certification that (A) the installation and commissioning of the Seller-Owned Interconnection Facilities and the Company-Owned Interconnection Facilities built by Seller (and/or its Contractors) has been completed; and (B) a walk-through by Company shall demonstrate, to Company's reasonable satisfaction, Seller's readiness to commence with the Acceptance Test. If, after the site walk-through, Company representatives reasonably determine that Seller is not ready to commence with the Acceptance Test, in the Company's sole discretion based on its assessment of the

nature of Seller's lack of readiness and Company's resources and overall schedule of projects at the time, Company may assign Seller a new Test Ready Deadline and a new Acceptance Testing Milestone Date, which may be behind the other projects then in the queue, coinciding with the estimated time it would take Seller to become test-ready and Company's ability to commence the Acceptance Test. If prior to the new Test Ready Deadline established by Company, Seller becomes ready for the performance of the Acceptance Test, i.e., Seller provides Company with its fourteen (14) Day advance written notice of the commencement of the Acceptance Test (the "**Seller Accelerated Test Ready Deadline**"), and Company confirms, in its site walk-through of the Facility (which site walk-through the Company may waive in its sole discretion), that Seller is ready for the Acceptance Test, but Company is unable to perform the Acceptance Test within [ ] Days<sup>4</sup> (the "**Seller Accelerated Acceptance Testing Milestone Date**") and Company's inability to commence the Acceptance Test is solely due to the conditions set forth in **Section 3(a)(i) and (ii)** of this **Attachment G** (Company-Owned Interconnection Facilities), then, for up to the period of time from the Seller Accelerated Acceptance Testing Milestone Date to the date that Company commences performance of the Acceptance Test, Seller shall be entitled to a waiver of Daily Delay Damages that would otherwise be accruing if Seller ultimately fails to meet the Guaranteed Commercial Operations Date due to its failure to meet the original Test Ready Deadline specified in **Attachment K-1** (Seller's Conditions Precedent and Company Milestones). For clarity, and to explain the limited waiver of Daily Delay Damages provided for in the preceding sentence, if Seller misses its Test Ready Deadline by 45 Days and subsequently misses its Guaranteed Commercial Operations Date for that reason by 60 Days and the period of time between the Seller Accelerated Acceptance Testing Milestone Date and the commencement date of the Acceptance Test is 15 Days (and such delay is solely due to the conditions set forth in **Section 3(a)(i) and (ii)** of this **Attachment G** (Company-Owned Interconnection Facilities)), then Seller shall be entitled to a waiver of 15 Days of Daily Delay Damages otherwise accruing for Seller's failure to meet the Guaranteed Commercial Operations Date. If the above time periods remain the same but Seller only misses the Guaranteed Commercial Operations Date by 30 Days, Seller shall not be entitled to any Daily Delay Damages waiver as the 30-Day failure to meet the Guaranteed Commercial Operations Date would be attributable to the initial 45 Days that Seller missed the Test Ready Deadline. Finally, if the above time periods remain the same but Seller misses its Guaranteed Commercial Operations Date by 50 Days, Seller shall be entitled to only a 5 Day waiver of Daily Delay Damages. In the meantime, Seller shall remediate the deficiencies identified by Company, and the process described in this **Section 3** (Acceptance Test Procedures) of **Attachment G** (Company-Owned Interconnection Facilities), shall commence again until Seller's readiness for the Acceptance Test is demonstrated to Company's reasonable satisfaction. Successful completion of the Acceptance Test requires successful completion of each of the individual tests that comprise the Acceptance Test. Retesting of any individual test constitutes a restart of the Acceptance Test if such retesting is required because of a prior failure of such individual test or because a prior test could not be completed because of a problem with the Facility. Within fifteen (15) Business Days of successful completion of the Acceptance Test and Company's receipt of the final report setting forth the results of the Acceptance Test, Company shall notify Seller in writing

---

<sup>4</sup> This would be the number of Days between the Test Ready Deadline and the Acceptance Testing Milestone Date stated in the Company Milestones of Attachment K-1.



whether the Acceptance Test has been passed and, if so, the date upon which the Acceptance Test was passed.

(d) Company will be present when the Acceptance Test is conducted, and Seller shall promptly correct any deficiencies identified during the Acceptance Test. Seller will be responsible for the cost of Company personnel (and/or Company contractors) performing the duties (such as reviewing the Plans and reviewing the construction) necessary for Company-Owned Interconnection Facilities to be constructed by Seller (and/or its Contractors). If Company (i) does not make any inspection or test; (ii) does not discover defective workmanship, materials or equipment; or (iii) accepts Company-Owned Interconnection Facilities (that were constructed by Seller and or its Contractors), such action or inaction shall not relieve Seller from its obligation to do and complete the work in accordance with the Plans approved by Company.

**4. Ongoing Operation and Maintenance Charges.** Company shall bill Seller periodically as costs are incurred for any reasonable costs incurred in operating, maintaining and replacing (to the extent not covered by insurance) Company-Owned Interconnection Facilities. Company's costs will be determined on the basis of, but not limited to, direct payroll, material costs, applicable overhead at the time incurred, consulting fees and applicable taxes. Seller shall, within thirty (30) Days after receipt of an invoice, reimburse Company for such billed operation and maintenance charges. Company's invoice will include itemized charges reasonably necessary for Seller to verify the basis for such charges.

**5. Relocation of Company-Owned Interconnection Facilities.**

(a) In the event that the Company-Owned Interconnection Facilities must be relocated for any reason not caused by Company, Seller shall bear the cost of such relocation. Prior to the relocation of the Company-Owned Interconnection Facilities Company shall invoice Seller for the total estimated cost of relocating the Company-Owned Interconnection Facilities (the "**Total Estimated Relocation Cost**"). Seller shall, within thirty (30) Days after the invoice date, pay to Company the Total Estimated Relocation Cost.

(b) Once the relocation of the Company-Owned Interconnection Facilities is complete, Company shall conduct a final accounting of all costs related thereto. Within thirty (30) Days of the final accounting, which shall take place within one hundred and twenty (120) Days of completion of the relocation of Company-Owned Interconnection Facilities, Seller shall remit to Company the difference between the Estimated Relocation Cost paid to date and the total actual relocation cost incurred by Company (the "**Total Actual Relocation Cost**"). If the Total Actual Relocation Cost is less than the payments received by Company as the Total Estimated Relocation Cost, Company shall repay the difference to Seller within thirty (30) Days of the final accounting.

**6. Guarantee for Interconnection Costs.**

(a) **Standby Letter of Credit.** To ensure payment by Seller of all costs and expenses incurred by Company, if applicable, in excess of the Total Estimated

Relocation Costs paid in connection with the relocation of the Company-Owned Interconnection Facilities as provided in **Section 5** (Relocation of Company-Owned Interconnection Facilities) of this **Attachment G** (Company-Owned Interconnection Facilities), Seller shall obtain an Irrevocable Standby Letter of Credit with no Documentary Requirement (“**Standby Letter of Credit**”) in accordance with the requirements of **Section 6(b)** (Requirements of the Standby Letter of Credit) of this **Attachment G** (Company-Owned Interconnection Facilities), wherein Company shall receive payment from the bank upon request by Company.

**(b) Requirements of the Standby Letter of Credit.** The Standby Letter of Credit shall be (i) in an amount not less than twenty-five percent (25%) of the Total Estimated Relocation Cost, as applicable, and (ii) in substantially in the form attached to this Agreement as **Attachment M** (Form of Letter of Credit) from a bank chartered in the United States with a credit rating of “A-” or better. If the rating (as measured by Standard & Poor’s) of the bank issuing the Standby Letter of Credit falls below A-, Company may require Seller to replace the Standby Letter of Credit with a Standby Letter of Credit from another bank chartered in the United States with a credit rating of “A-” or better. The Standby Letter of Credit shall be effective within thirty (30) Days after Seller receives the invoice from Company for the Total Estimated Relocation Cost as set forth in **Section 5** (Relocation of Company-Owned Interconnection Facilities) of this **Attachment G** (Company-Owned Interconnection Facilities). The Standby Letter of Credit shall be in effect through the earlier of forty-five (45) Days after the final accounting or seventy-five (75) Days after the Agreement is terminated. Seller shall provide to Company within fourteen (14) Days of the date the Standby Letter of Credit is to be effective as aforesaid, a document from the bank which indicates that such a Standby Letter of Credit has been established.

**(c) Other Form of Security.** Notwithstanding the foregoing, in lieu of a Standby Letter of Credit, Company may, at its sole discretion, agree in writing to accept such other form of security it deems to provide protection equivalent to a Standby Letter of Credit.

## **7. Land Restoration.**

**(a) Removal of Interconnection Facilities.** After termination of this Agreement or in the event this Agreement is declared null and void under either **Section 2.3** (Interconnection Requirements Study), **Section 3.4** (Prior to Effective Date), **Section 24.3** (Time Period for PUC Submittal Date), or **Section 24.4** (Time Period for PUC Approval) of this Agreement, Seller shall, at its sole cost and expense, remove the Seller-Owned Interconnection Facilities from the Land, and, in conjunction with such removal, shall develop and implement a program to recycle, to the fullest extent possible, or to otherwise properly dispose of, all such removed infrastructure; provided, however, that, Company may elect to remove all or part of the Seller-Owned Interconnection Facilities from the Land because of operational concerns over the removal of such Interconnection Facilities, in which case Seller shall reimburse Company for its costs to remove such Seller-Owned Interconnection Facilities. To the extent Seller is obligated to remove Seller-Owned Interconnection Facilities, Seller shall complete such removal within ninety (90) Days of termination of this Agreement (or declaration that the Agreement is null and void under either **Section 2.3** (Interconnection Requirements Study), **Section 3.4** (Prior to Effective Date), **Section**

**24.3** (Time Period for PUC Submittal Date), or **Section 24.4** (Time Period for PUC Approval) of this Agreement, or as otherwise agreed to by both Parties in writing.

**(b) Restoration of the Land.** After the termination of this Agreement (or declaration that the Agreement is null and void under either **Section 2.3** (Interconnection Requirements Study), **Section 3.4** (Prior to Effective Date), **Section 24.3** (Time Period for PUC Submittal Date), or **Section 24.4** (Time Period for PUC Approval) of this Agreement) and removal of the Seller-Owned Interconnection Facilities, Seller shall, at its sole cost and expense, restore the Land to its condition prior to construction of such Company-Owned Interconnection Facilities and/or Seller-Owned Interconnection Facilities, as applicable. Land restoration shall be completed within ninety (90) Days of termination of this Agreement (or declaration that the Agreement is null and void under either **Section 2.3** (Interconnection Requirements Study), **Section 3.4** (Prior to Effective Date), **Section 24.3** (Time Period for PUC Submittal Date), or **Section 24.4** (Time Period for PUC Approval) of this Agreement), or as otherwise agreed to by both Parties in writing.

**ATTACHMENT H  
RESERVED**

**ATTACHMENT I  
RESERVED**

**ATTACHMENT J**  
**ADJUSTMENT TO LUMP SUM PAYMENT**

Under the Company’s previous forms of as-available power purchase agreements for renewable energy, the independent power producer was compensated for the production and delivery of electrical energy and assumed the risk of non-payment for events such as Force Majeure that prevented such production and delivery. Although under this Agreement Seller’s compensation will be in the form of a Lump Sum Payment rather than for the production and delivery of electrical energy, it is not the intent of the Parties that Seller should be entitled to unrestricted compensation in circumstances in which an independent power producer would not have been able to earn compensation under the Company’s prior form of power purchase agreements (i.e., if the Facility or any portion thereof is unable to receive and/or deliver electric energy). Although the liquidated damages that are payable if the Measured Availability fails to achieve the Performance Level Availability address this issue in certain of the circumstances when the Facility or a portion thereof is unable to receive or deliver electric energy, the Measured Availability does not account for events of Force Majeure because such events are included in the ExcludedTime classification under **Attachment U** (Measured Availability) to this Agreement. Accordingly, the monthly Lump Sum Payment shall be adjusted downward pro rata for each hour or portion thereof during the calendar month in question that the Facility or a portion thereof was not available to respond to Company Dispatch/Charge because of a Force Majeure condition (a) affecting the Facility or any portion thereof or (b) that otherwise delays or prevents Seller from making the Facility inverter(s) in question or a portion thereof available for Company Dispatch/Charge. The hours the Facility is affected by a Forced Majeure are converted to equivalent full outage hours by multiplying the actual duration of the event (hours) by (i) the size of the reduction in MWs or number of devices, divided by (ii) the Contract Capacity if the size of the reduction is in MWs or the total number of devices in the affected system if the size of the reduction is a device count. These equivalent hour(s) are then summed. The summation of equivalent full outage hours is then divided by the months total period hours (number of days in the month x 24hrs/day) to determine the pro-rated factor the Lump Sum Payment will be adjusted by.

Example: If a Facility has forty (40) battery energy storage system modules and, during the month of June (which has 720 period hours), one (1) module is not available to respond to Company Dispatch/Charge for a period of 240 hours due to a Force Majeure condition as aforesaid, the monetary amount of the resulting downward adjustment to the monthly Lump Sum Payment for the month of June would be calculated as follows:

$$\text{Monetary Amount of Downward Adjustment} = \text{MLSP} \times \frac{1}{40} \times \frac{240}{720}$$

where:

MLSP = The monthly Lump Sum Payment that would be payable for such month but for the downward adjustment

For purposes of determining the monetary amount of the foregoing downward adjustment, the product obtained by multiplying a monetary value by a fraction shall be rounded to the nearest cent.

**[Attachment K will be revised to reflect the results of the IRS]**

**ATTACHMENT K**  
**GUARANTEED PROJECT MILESTONES**

**Guaranteed Project  
Milestone Date**

**Description of Each Guaranteed Project  
Milestone**

**[SPECIFY DATE CERTAIN]**

Construction Financing Milestone: Seller shall provide Company with documentation reasonably satisfactory to Company evidencing (a) the closing on financing for the Facility including ability to draw on funds by **[insert same date certain as in left column]** or (b) the financial capability to construct the Facility

**[SPECIFY DATE CERTAIN]**

Permit Application Filing Milestone: Seller shall provide Company with documentation reasonably satisfactory to Company evidencing the filing by or on behalf of Seller of the following applications for Governmental Approvals required for the ownership, construction, operation and maintenance of the Facility: **[INSERT LIST OF GOVERNMENTAL APPROVALS]**

**[SPECIFY DATE CERTAIN]**

Guaranteed Commercial Operations Date



**[Attachment K will be revised to reflect the results of the IRS]**

**ATTACHMENT K-1**  
**SELLER'S CONDITIONS PRECEDENT AND COMPANY**  
**MILESTONES**

<b>Seller's Conditions Precedent Date</b>	<b>Description of Each of Seller's Conditions Precedent</b>
	Seller's EPC Contractor shall obtain grading permit.
<b>No later than three (3) months prior to commencement of the Acceptance Test</b>	Seller shall provide station service power, if applicable, as required by Company.
<b>No later than three (3) months prior to the commencement of the Acceptance Test</b>	Seller or Seller's EPC Contractor shall have Hawaiian Telcom Backup (or equivalent) installed which shall consist of a 1.5 Mbps Routed Network Services circuit for backup SCADA communications from Company's Substation at Seller's Facility to Company's EMS located at the Company's control center.
	Seller's EPC Contractor shall complete installation of physical bus and structures within Company's substation up to the demark point as necessary to interconnect.
<b>[specify date] ("Test Ready Deadline")</b>	Seller's EPC Contractor shall complete construction of the Seller-Owned Interconnection Facilities, Seller shall have satisfied the conditions precedent to the conduct of the Acceptance Test set forth in <b>Section 3(b) of Attachment G</b> (Company-Owned Interconnection Facilities) and Seller is otherwise ready to conduct the Acceptance Test.
	Seller shall close grading permit, unless Seller provides documentation establishing, to Company's reasonable satisfaction, that closing the grading permit is not required by the relevant Governmental Authority prior to energization, testing and use of the Facility.

COMPANY MILESTONES

If Seller satisfies the foregoing Seller's Conditions Precedent, the following Company Milestones shall apply:

<b>Company Milestone Date</b>	<b>Description of Each Company Milestone</b>
<b>[ ] Business Days following the Test Ready Deadline</b>	Company shall, subject to Seller's continued satisfaction of the requirements set forth in <b>Section 3(b)</b> and <b>Section 3(c)</b> of <b>Attachment G</b> (Company-Owned Interconnection Facilities), commence Acceptance Testing.
	Energization of Company-Owned Interconnection Facilities, provision of back-feed power to support commissioning.

**[Attachment L will be revised to reflect the results of the IRS]**

**ATTACHMENT L**  
**REPORTING MILESTONES**

<b>Reporting Milestone Date</b>	<b>Description of Each Reporting Milestone</b>
[Date]	Seller shall provide Company with a redacted copy of the executed Facility equipment, engineering, procurement and construction, or other general contractor agreements; provided, that, under no circumstances shall redactions conceal information that is necessary for Company to verify its rights under the Agreement
[Date]	Seller shall provide Company with redacted copies of executed purchase orders/contracts for the delivery and installation of Facility inverters
[Date]	Seller shall provide Company with copies, as applicable, of executed Facility operating agreements
[Date]	Construction Start Date (defined as the start of civil work on Site)
[Date]	Seller shall have laid the foundation for all Facility buildings and step-up transformer facilities
[Date]	All inverters for the Facility shall have been installed at the Site
[Date]	The step-up transformer shall have been installed at the Site

**ATTACHMENT M**  
**FORM OF LETTER OF CREDIT**

**[Bank Letterhead]**

**[Date]**

**Beneficiary: Hawai'i Electric Light Company, Inc.**  
**[Address]**

**[Bank's Name]**  
**[Bank's Address]**

Re: **[Standby Letter of Credit Number]**

Ladies and Gentlemen:

We hereby establish, in your favor, our standby Letter of Credit Number \_\_\_\_\_ (this "**Letter of Credit**") for the account of **[Applicant's Name]** and **[Applicant's Address]** in the initial amount of \$\_\_\_\_\_ **[dollar value]** and authorize you, Hawai'i Electric Light Company, Inc. ("**Beneficiary**"), to draw at sight on **[Bank's Name]**.

Subject to the terms and conditions hereof, this Letter of Credit secures **[Project Entity Name]**'s certain obligations to Beneficiary under the Energy Storage Services Agreement dated as of \_\_\_\_\_ between **[Project Entity Name]** and Beneficiary.

This Letter of Credit is issued with respect to the following obligations:  
\_\_\_\_\_.

This Letter of Credit may be drawn upon under the terms and conditions set forth herein, including any documentation that must be delivered with any drawing request.

Partial draws of this Letter of Credit are permitted. This Letter of Credit is not transferable. Drafts on us at sight shall be accompanied by a Beneficiary's signed statement signed by a representative of Beneficiary as follows:

The undersigned hereby certifies that (i) I am duly authorized to execute this document on behalf of Hawai'i Electric Light Company, Inc., and [(ii) the amount of the draft accompanying this certification is due and owing to Hawai'i Electric Light Company, Inc. under the terms of the Energy Storage Services Agreement dated as of \_\_\_\_\_, between \_\_\_\_\_ and Hawai'i Electric Light Company, Inc.] [(ii) the Letter of Credit will expire in less than thirty (30) days, it has not been replaced or extended and collateral is still required under **Section** \_\_\_ of the Energy Storage Services Agreement.<sup>5</sup>]

Such drafts must bear the clause "Drawn under **[Bank's Name and Letter of**

---

<sup>5</sup> For draw relating to lapse of Letter of Credit while credit support is still required pursuant to the Energy Storage Services Agreement.

**Credit Number \_\_\_\_\_ and date of Letter of Credit.]”**

All demands for payment shall be made by presentation of originals or copies of documents, or by facsimile transmission of documents to **[Bank Fax Number]** or other such number as specified from time to time by the bank, or by email transmission of documents in PDF format to **[Bank Email Address]** or other such email address as specified from time to time by the bank. If presentation is made by facsimile transmission or email transmission, you may contact us at **[Bank Phone Number]** to confirm our receipt of the transmission. Your failure to seek such a telephone confirmation does not affect our obligation to honor such a presentation. If presented by facsimile or email, original documents are not required.

This letter of credit shall expire one year from the date hereof. Notwithstanding the foregoing, however, this letter of credit shall be automatically extended (without amendment of any other term and without the need for any action on the part of the undersigned or Beneficiary) for one year from the initial expiration date and each future expiration date unless we notify you and Applicant in writing at least thirty (30) days prior to any such expiration date that this letter of credit will not be so extended. Any such notice shall be delivered by registered or certified mail, or by FedEx, both to:

Beneficiary at:

---

---

---

---

and to

---

---

---

---

And to Applicant at:

---

---

---

---

We hereby agree with drawers that drafts and documents as specified above will be duly honored upon presentation to **[Bank’s Name]** and **[Bank’s Address]** if presented on or before the then-current expiration date hereof.

Payment of any amount under this Letter of Credit by **[Bank]** shall be made as the Beneficiary shall instruct on the next Business Day after the date the **[Bank]** receives

all documentation required hereunder, in immediately available funds on such date. As used in this Letter of Credit, the term "Business Day" shall mean any day other than a Saturday or Sunday or any other day on which banks in the State of **[Insert State of issuing Bank's location]** are authorized or required by law to be closed.

Unless otherwise expressly stated herein, this irrevocable standby letter of credit is issued subject to the rules of the International Standby Practices, International Chamber of Commerce publication no. 590 ("**ISP98**").

**[Bank's Name]:**

By: \_\_\_\_\_  
**[Authorized Signature]**

**ATTACHMENT N**  
**ACCEPTANCE TEST GENERAL CRITERIA**

**[This Attachment to be modified based on the type/design of the Facility and the results of the IRS]**

Upon final completion of Company review of the Facility's drawings, final test criteria and procedures shall be agreed upon by Company and Seller no later than thirty (30) Days prior to conducting the Acceptance Test in accordance with the Agreement. Seller shall be responsible for all Company costs associated with conducting the Acceptance Test. The Acceptance Test shall include, but not be limited to, the following:

**1. Interconnection.**

(a) A visual inspection of all Interconnection equipment and verification of as-built drawings.

(b) Phase rotation testing to verify proper phase connections.

(c) Based on manufacturer's specification, test the local operation of the Facility's generator breaker(s) and inter-tie breaker(s), and other breaker(s) which connect the Facility equipment to Company System – must open and close locally using the local controls remotely from Company's EMS. Test and ensure that the status shown on the EMS is the same as the actual physical status in the field.

(d) Relay test engineers to connect equipment and simulate certain inputs to test and ensure that the protection schemes such as any under/overfrequency and under/overvoltage protection or the Direct Transfer Trip operate as designed. (For example, a fault condition may be simulated to confirm that the breaker opens to sufficiently clear the fault. Additional scenarios may be tested and would be outlined in the final test criteria and procedures.) Seller to also test the synchronizing mechanisms to which the Facility would be synchronizing and closing into the Company System to ensure correct operation. Other relaying also to be tested as specified in the protection review of the IRS and on the single line diagram, **Attachment E** (Single-Line Drawing and Interface Block Diagram) for the Facility.

(e) All 34.5 kV breaker disconnects and other high voltage switches will be inspected to ensure they are properly aligned and operated manually or automatically (if designed).

(f) Step-Up Transformer Enclosure(s) inspections – The Step-Up Transformer Enclosure(s) may be inspected to test and ensure that the equipment that Seller has installed is installed and operating correctly based upon agreed to design. Wiring may be field verified on a sample basis against the wiring diagrams to ensure that the installed equipment is wired properly. The grounding mat at the Step-Up Transformer Enclosure(s) may be tested to make sure there is adequate grounding of equipment.

(g) Communication testing – Communication System testing to occur to

ensure correct operation. Detailed scope of testing will be agreed by Company and Seller to reflect installed systems and communication paths that tie the Facility to Company's communications system.

**(h)** Various contingency scenarios to be tested to ensure adequate operation, including testing contingencies such as loss of communications, and fault simulations to ensure that the Facility's 34.5 kV breakers, if any, open as they are designed to open. (Back up relay testing)

**(i)** Metering section inspection; verification of metering PTs, CTs, and cabinet and the installation of the two Company meters.

## **2. Telephone Communication.**

**(a)** Test to confirm Company has a direct line to the Facility control room at all times and that it is programmed correctly.

**(b)** Test to confirm that the Facility operators can sufficiently reach Company System Operator.

**(c)** Verification of dial-up telephone connection for 34.5 kV metering cabinet.

## **3. Drawings, Documentation and Equipment Warranties.**

The items below are required components of the Acceptance Test and must be satisfied for successful completion of this Test.

**(a)** Electronic and three (3) hard copies of all Switchyard construction drawings, specifications, calibrations, and settings including as-built drawings.

**(b)** Equipment operating and maintenance manuals, spare parts lists, commissioning notes, as-built equipment settings, and other information related to the switchyard equipment.

**(c)** Contractor construction warranties and equipment warranties.

**(d)** Phase rotation testing to verify proper phase connections.

**(e)** Switching Station inspections – The Switching Station may be inspected to test and ensure that the equipment that Seller has installed is installed and operating correctly based upon agreed-to design. Wiring may be field verified on a sample basis against the wiring diagrams to ensure that the installed equipment is wired properly. The grounding mat at the Switching Station may be tested to make sure there is adequate grounding of equipment.

**(f)** If agreed by the Parties in writing, some requirements may be postponed to the Control Systems Acceptance Test.



**ATTACHMENT O**  
**CONTROL SYSTEM ACCEPTANCE TEST CRITERIA**

**[This Attachment to be modified based on the type/design of the Facility and the results of the IRS]**

- a. The Acceptance Test for the Facility will be conducted, following installation of the Facility. Seller shall be responsible for all Company costs associated with conducting the Control System Acceptance Test. The Acceptance Test procedures will be in accordance with criteria set forth herein. The Acceptance Test shall be performed in accordance with Good Engineering and Operating Practices and demonstrate to Company's satisfaction that the Facility and the interconnection portion of the Facility, including Company-Owned Interconnection Facilities, have met the provisions of **Article 12** (Dispatching and Charging the Facility; Scheduling) and **Section 3** (Performance Standards) of **Attachment B** (Facility Owned by Seller).
- b. Acceptance Test procedures will be developed by Company for the Seller's review at least sixty (60) Days in advance of performing the tests based on the date provided by Company.
- c. The procedures will include, but not be limited to, demonstration of the functional requirements of the Facility defined in **Article 12** (Dispatching and Charging the Facility; Scheduling) and **Section 3** (Performance Standards) of **Attachment B** (Facility Owned by Seller) such as, but not limited to:
  - i. Interconnection equipment and communications to support remote monitoring of the Facility and control of Facility breakers
  - ii. Droop characteristic and change of frequency control / response modes (if applicable)
  - iii. Real power delivery under remote Company Dispatch, Active Power Dispatch. For facilities with directly controlled storage, the storage will be operated to perform at least two full charging/discharging cycles.
  - iv. Accurate provision of limits for Minimum and Maximum Dispatch (Power Possible, Minimum load capability)
  - v. Ramp rates for controlled actions
  - vi. Control of Facility breakers
  - vii. Voltage regulation
  - vii. Grid forming and Black-Start
  - viii. Capacity Test and demonstration of round trip efficiency of the BESS, each as described in **Attachment T** (Capacity Ratio and RTE Ratio)

- d. Testing of primary and redundant communications between Company System Operator and Facility Operator
- e. The actual dynamic response of the Facility equipment will be confirmed to allow Company transient stability model to reflect the as-left conditions of the unit. During the commissioning the following will be required:
  - i. A final review by Company engineers of the equipment installed to control the operation and protect the plant will be needed upon installation and prior to the start of commercial operation.
  - ii. The review will include off-line tuning and testing results of the excitation and governor control and/or control system and the IEEE block diagram utilized for the PSS/E dynamics program.
  - iii. During the commissioning of the actual Facility, equipment system testing will be conducted to ensure that similar, well damped, expected responses will be produced by the facility. The as-left parameters obtained from real and reactive local response tuning will be determined for use in the Company planning model. The Seller will provide an estimate of the earliest date for the Acceptance Test at least ninety (90) Days before the date.
- f. The Acceptance Test procedures for the Facility will be mutually agreed upon between Seller and Company prior to conducting the test.
- g. When the Facility is ready for the Acceptance Test, Seller shall notify Company at least seven (7) Days prior to the test and shall coordinate with Company. Seller shall perform and Company shall monitor such test no earlier than seven (7) Days from Company's receipt of such notice.
- h. The Control Acceptance Test is to be successfully completed prior to the Commercial Operation Date.

Examples of the type of tests conducted to meet the aforementioned objectives may include, but are not limited to the following:

On-site Tests:

1. SCADA Test to verify the status and analog telemetry, and if the remote controls between the Company's EMS and the Facility are working properly end-to-end.
2. Dispatch Test to verify if the Facility's active power limit controls and the Active Power Control Interface with the Company's EMS are working properly. The Test is generally conducted by setting different active power setpoints and limits and observing the proper dispatch at the appropriate ramp rate limiting of the Facility's real power output.
3. Control Test for Voltage Regulation to verify the Facility can properly perform

automatic voltage regulation as defined in this Agreement. Test is generally conducted by making small adjustments of the voltage setpoint and verifying by observation that the Facility regulates the voltage at the point of regulation to the setpoint by delivering/receiving reactive power to/from the Company System to maintain the applicable setpoint according to the reactive power control and the reactive amount requirements of **Sections 3(a)** (Reactive Power Control) and **Section 3(b)** (Reactive Power Characteristics) of **Attachment B** (Facility Owned by Seller) to this Agreement.

4. Frequency Response Test to verify the Facility provides a frequency droop response as defined in this Agreement. Test is generally conducted by making adjustments of the frequency reference setting and verifying by observation that the Facility responds per droop and deadband settings, and appropriately modifies the Company issued Dispatch Setpoint. If different modes of frequency response are provided, each mode is tested (i.e.; isochronous, fast frequency response, active power droop response).
5. Loss-of-Communication Test to verify the Facility will properly shutdown upon the failure of the active power control system. Test is generally conducted by simulating a communications failure and observing the proper shutdown of the Facility. [If DTT required for the project]
6. Round Trip Efficiency Test, as described in **Attachment T** (Capacity Ratio and RTE Ratio) to verify that the round trip efficiency of the BESS is not less than eighty-five percent (85%).
7. Capacity Test to verify the Capacity Ratio.

Monitoring Test:

- a) The monitoring test requires the Facility to operate as it would in normal operations.
- b) To ensure useful and valid test data is collected for variable facilities, the monitoring test shall end 14 continuous Days from the start of the CSAT.
- c) At the end of the test, an evaluation period is selected based on the criteria that triggered the end of the test.
- d) The performance of the Facility during the period of the successfully completed monitoring test is evaluated for, e.g. voltage regulation, frequency response, dispatch control, operating limits and ramp rate performance, to verify the performance meets the requirements of this Agreement according to the criteria set forth in the testing procedures. Certain requirements, such as disturbance ride-through requirements, cannot be adequately tested without actual grid disturbances. These requirements will be confirmed following a grid event based on operational data, which may be after the completion of the Acceptance Test. The Parties understand and agree that a successful completion of the test does not constitute a waiver of any of the performance standards of Seller, all of which are hereby reserved, and shall not alleviate Seller from any of its obligations under the Agreement, in particular, as required in **Article 12** (Dispatching and Charging the Facility; Scheduling) and the

Performance Standards in **Section 3** (Performance Standards) of **Attachment B**  
(Facility Owned by Seller).

**ATTACHMENT P**  
**SALE OF FACILITY BY SELLER**

**1. Company's Right of First Negotiation Prior to End of the Term.**

**(a) Right of First Negotiation.** Commencing as of the Commercial Operations Date, should Seller desire to sell, transfer or dispose of its right, title, or interest in the Facility, in whole or in part, including a Change in Control (as defined below), then, other than through an "**Exempt Sale**" (as defined below):

**(i)** Seller shall first offer to sell such interest to Company by providing Company with written notice of the same (the "**Offer Notice**"), which notice shall identify the proposed purchase price for such interest (including a description of any consideration other than cash that will be accepted) (the "**Offer Price**") and any other material terms of the intended transaction, and Company may, but shall not be obligated to, purchase such interest at the Offer Price and upon the other material terms and conditions specified in the Offer Notice, and in accordance with the terms and conditions of this **Attachment P** (Sale of Facility by Seller). Seller shall provide to Company as part of the Offer Notice, information in its possession regarding the Facility to allow Company to conduct due diligence on the potential purchase, including, but not limited to information on the operational status of the Facility and its components, and the amount of debt or other material Seller obligations remaining with respect to the Facility (the Offer Notice and due diligence information on the Facility are collectively referred to as, the "**Offer Materials**"). Within five (5) Days of Company's receipt of the Offer Materials, if Company believes the due diligence information is incomplete, Company shall specify in writing the additional information Company requires to conduct its due diligence. The date on which Company receives the Offer Materials from Seller is referred to hereinafter as the "**Offer Date.**"

**(ii)** If Company desires to purchase such interest, Company shall indicate so by delivering to Seller a binding, written offer to purchase such interest at the Offer Price and on the terms and conditions specified in the Offer Notice within thirty (30) Days of the Offer Date (an "**Acceptance Notice**"). In the event Company timely delivers an Acceptance Notice, Seller shall sell and transfer to Company the interest substantially on the terms and conditions contained in the Offer Notice consistent with this **Attachment P** (Sale of Facility by Seller) and in accordance with definitive documentation to be entered into between Seller and Company. The Parties shall have sixty (60) Days from the Company's Acceptance Notice, or such other extended timeframe as agreed to by the Parties in writing, to negotiate in good faith, the terms and conditions of a purchase and sale agreement. The period beginning with the Offer Date and ending with such sixty (60) Day period (as may be extended as aforesaid) is referred to as the "**Right of First Negotiation Period.**"

**(iii)** Seller shall not solicit any offers for the sale of such interest to any other party during the Right of First Negotiation Period unless, during that period, Company provides Seller with written notice that Company no longer desires to purchase such interest, whereupon negotiations shall terminate.

**(iv)** In the event that (A) Company fails to timely deliver an Acceptance Notice, (B) Company delivers a notice to Seller that it no longer desires to purchase the interest, or (C) the Parties are not able to execute a purchase and sale agreement within the 60-Day period set forth in **Section 1(a)(ii)** of this **Attachment P** (Sale of Facility by Seller), Seller may for a period of one hundred eighty (180) Days following the event specified in subsection (A), (B) or (C) above, commence solicitation of offers and negotiations from and with other parties for the sale of such interest. If the interest is not transferred to a purchaser or purchasers for any reason within the one hundred eighty (180) Day period, the interest may only be transferred by again complying with the procedures set forth in this **Section 1(a)** (Right of First Negotiation) of **Attachment P** (Sale of Facility by Seller); provided, however, if Seller and the prospective purchaser have entered into definitive agreement(s) for the sale of the interest that was reasonably expected to close within such one hundred eighty (180) Day period and such agreement(s) remain in full force and effect between Seller and such prospective purchaser and are subject to conditions precedent that are expected to be satisfied within a reasonable period, the one hundred eighty (180) Day period shall be extended as to such agreement(s) and such prospective purchaser for up to ninety (90) additional Days or, if sooner, until such date that such agreement(s) have been terminated, cancelled or otherwise become no longer in full force and effect.

**(v)** After expiration of the Right of First Negotiation Period, Company will not be precluded from providing offers or proposals to Seller along with other prospective purchasers in accordance with any offer or bid procedures established by Seller in its discretion.

**(b) Change in Ownership Interests and Control of Seller.** Commencing as of the Commercial Operations Date, the Right of First Negotiation shall also be triggered by a transfer or sale of an ownership interest in Seller (whether in a single transaction or a series of related or unrelated transactions) following which **[Insert Parent Entity]** or an entity controlled by **[Parent Entity]** is no longer a direct or indirect owner of at least fifty-one percent (51%) of the equity interest or voting control of Seller (excluding any equity interest or voting control of Seller held by a tax equity investor or for Financing Purposes (as defined below)) (such transfer of ownership interest and change in control collectively referred to as a “**Change in Control**”); provided, however that a transfer or sale whereby **[Parent Entity]** retains the possession, directly or indirectly, or the power to direct or cause the direction of the management and policies of Seller, whether through ownership, by contract, or otherwise, shall not be deemed a Change in Control.

**(c) Exempt Sales.** Exempt Sales shall not trigger a Right of First Negotiation and shall not require the consent of Company. As used herein, “**Exempt Sales**” means: (i) a change in ownership of the Facility or equity interests in Seller resulting from the direct or indirect transfer or assignment by or of Seller in connection with financing or refinancing of the Facility (“**Financing Purposes**”), including, without limitation, any exercise of rights or remedies (including foreclosure) with respect to Seller's right, title, or interest in the Facility or equity interests in Seller undertaken by any financing party in accordance with applicable financing documents, and including, without limitation, (x) a sale and leaseback of the Facility, (y) an inverted lease, (z) a sale or transfer of equity in Seller to facilitate a tax credit financing (including any partnership "flip" transaction), (ii) a disposition of equipment

in the ordinary course of operating and maintaining the Facility, (iii) a sale that does not result in a Change in Control, and (iv) a sale or transfer of any interest in Seller or the Facility to one or more companies directly or indirectly controlling, controlled by or under common control with Seller.

**(d) Seller's Right to Transfer.** The provisions of this **Section 1(d)** (Seller's Right to Transfer) shall apply (i) from the Execution Date through the Commercial Operations Date and (ii) from the Commercial Operations Date in the event that Company does not consummate a purchase pursuant to its exercise of the Right of First Negotiation in accordance with the terms and conditions of this **Attachment P** (Sale of Facility by Seller). In such circumstances, Seller shall, subject to the prior written consent of Company, which consent shall not be unreasonably withheld, conditioned or delayed, have the right to transfer or sell the Facility to any person or entity which proposes to acquire the Facility with the intent to continue the operation of the Facility in accordance with the provisions of this Agreement pursuant to an assignment of this Agreement. Company shall consent to the assignment of this Agreement to such prospective purchaser upon receiving documentation from Seller establishing, to Company's reasonable satisfaction, that the assignee (i) has a tangible net worth of \$100,000,000 or a credit rating of "BBB-" or better and has the ability to perform its financial obligations hereunder (or provides a guaranty from an entity that meets this description) in a manner consistent with the terms and conditions of this Agreement; (ii) has experience in the ownership of battery energy storage systems; and (iii) has at least five (5) years of experience in the operation (or contracts with an entity that has at least five (5) years of experience in the operation) of battery energy storage systems. Notwithstanding the foregoing, Company consent shall not be required for any Exempt Sale.

**(e) Purchase and Sale Agreement and PUC Approval.** In the event that Company exercises its Right of First Negotiation under **Section 1(a)** (Right of First Negotiation) of this **Attachment P** (Sale of Facility by Seller) and the Parties conclude a purchase and sale agreement, such agreement shall contain, at a minimum, the terms set forth in **Section 4** (Purchase and Sale Agreement) of this **Attachment P** (Sale of Facility by Seller), and such agreement shall be subject to PUC Approval as provided in **Section 5** (PUC Approval) of this **Attachment P** (Sale of Facility by Seller).

**(f) Right of First Refusal.** In the event the Parties fail to agree upon a sale of the Facility or an interest in the Facility to Company prior to the expiration of the Right of First Negotiation Period, the provisions of this **Section 1(f)** (Right of First Refusal) of this **Attachment P** (Sale of Facility by Seller) shall apply if (i) Seller thereafter offers to sell the Facility to a third party for less than (as applicable) the final amount Company had offered to purchase the Facility or (ii) an ownership interest in the Facility that would result in a Change in Control is offered for sale to a third party that is less than the proportionate share of (as applicable) the final amount Company had offered to purchase the Facility. (By way of example, if the final amount offered by Company to purchase the Facility was \$100, and the ownership interest being offered for sale is 75%, the "proportionate share" is \$75, such that an offer to sell such ownership interest for less than \$75 would trigger this **Section 1(f)** (Right of First Refusal) of this **Attachment P** (Sale of Facility by Seller).) Seller shall notify Company in writing of an offer that triggers this **Section 1(f)** (Right of First Refusal) of this **Attachment P** (Sale of Facility by Seller) and Company shall have the right to

purchase the Facility for the amount of such offer on similar terms and conditions consistent with this **Attachment P** (Sale of Facility by Seller) and subject to PUC Approval; provided, that Company shall have one (1) month in which to notify Seller of its intent to exercise this right. If the offer of which Seller notifies Company as aforesaid is an offer to sell the Facility, Company shall have the right to purchase the Facility for the amount of such offer on similar terms and conditions. If the offer of which Seller notifies Company as aforesaid is an offer to sell an ownership interest that could result in a Change in Control, Company shall have the right to purchase the Facility by a price that is proportionate to the amount at which such ownership interest was offered on the terms and conditions to be negotiated by the Parties on the basis of **Section 4** (Purchase and Sale Agreement) of this **Attachment P** (Sale of Facility by Seller), and otherwise consistent with this **Attachment P** (Sale of Facility by Seller). (By way of example, if a 75% ownership Interest is being offered for sale at \$75, the proportionate amount at which Company shall have the right to purchase the Facility would be \$100.)

## **2. Company's Right of First Negotiation to Purchase at End of Term.**

**(a) Option of Exclusive Negotiation Period.** Company shall have the option of an exclusive negotiation period to negotiate a purchase of the Facility on the last Day of the Term, and all rights of Seller therein or relating thereto. Company shall indicate its preliminary interest in exercising the option for exclusive negotiation by delivering to Seller a notice of its preliminary interest not less than two (2) years prior to the last Day of the Term. If Company fails to deliver such notice by such date, Company's option shall terminate.

**(b) Negotiations.** Once Company has given such notice of preliminary interest to Seller, for a period not to exceed three (3) months, Company shall have the exclusive right to negotiate in good faith with Seller the terms of a purchase and sale agreement pursuant to which Company may purchase the Facility, which purchase and sale agreement shall include, without limitation, the terms set forth in **Section 4** (Purchase and Sale Agreement) of this **Attachment P** (Sale of Facility by Seller) and a price equal to the Offer Price as presented by Seller in accordance with the procedures identified in **Section 1(a)(i)** through **(v)** of this **Attachment P** (Sale of Facility by Seller). The Parties may agree in writing to extend this period for negotiations. (Such period, as extended as aforesaid, is referred to herein as the "**Exclusive Negotiation Period.**") Seller shall not solicit any offers or negotiate the terms for the sale of the Facility with any other entity during the Exclusive Negotiation Period, unless, during the Exclusive Negotiation Period, Company gives written notice that such negotiations are terminated.

**(c) Purchase and Sale Agreement and PUC Approval.** In the event that Company exercises its right of exclusive negotiation under **Section 2(a)** (Option of Exclusive Negotiation Period) of this **Attachment P** (Sale of Facility by Seller) and the Parties conclude a purchase and sale agreement pursuant to **Section 2(b)** (Negotiations) of this **Attachment P** (Sale of Facility by Seller), such agreement shall contain, at a minimum, the terms set forth in **Section 4** (Purchase and Sale Agreement) of this **Attachment P** (Sale of Facility by Seller), and such agreement shall be subject to PUC Approval as provided in **Section 5** (PUC Approval) of this **Attachment P** (Sale of Facility by Seller).



**(d) Right of First Refusal.** In the event the Parties fail to agree upon a sale of the Facility to Company prior to the expiration of the Exclusive Negotiation Period provided in **Section 2(b)** (Negotiations) of this **Attachment P** (Sale of Facility by Seller), and Seller thereafter offers to sell the Facility to a third party for less than the final amount Company had offered to purchase the Facility, Seller shall notify Company in writing of such offer and Company shall have the right to purchase the Facility for the amount of such offer and on no less favorable terms and conditions consistent with this **Attachment P** (Sale of Facility by Seller) and subject to PUC Approval; provided, however, that Company shall have one (1) month in which to notify Seller of its intent to exercise this right. The Right of First Refusal shall not apply to any offer to purchase the Facility received from a third party more than twelve (12) months after the end of the Term.

**3. Procedure to Determine Fair Market Value of the Facility.**

**(a)** If the Parties have agreed to effectuate a sale of the Facility pursuant to **Section 23.5** (Consolidation) and are unable to agree on the fair market value of the Facility, each of Company and Seller shall engage the services of an independent appraiser experienced in appraising battery energy storage system assets similar to the Facility to determine separately the fair market value of the Facility. Subject to the appraisers' execution and delivery to Seller of a suitable confidentiality agreement in form reasonably acceptable to Seller, Seller shall provide both appraisers full access to the books, records and other information related to the Facility required to conduct such appraisal. Company shall pay all reasonable fees and costs of both appraisers, subject to **Section 3(c)** of this **Attachment P** (Sale of Facility by Seller). Each of Company and Seller shall use reasonable efforts to cause its appraisal to be completed within two (2) months following the engagement of the independent appraisers. If for any reason (other than failure by Seller to provide full access to Company's appraiser) one of the appraisals is not completed within such two (2) month period, the results of the other, completed appraisal shall be deemed to be the Appraised Fair Market Value of the Facility. Each Party may provide to both appraisers (with copies to each other) a list of factors which the Parties suggest be taken into consideration when the appraisers generate their appraisals.

**(b)** Company and Seller shall exchange the results of their respective appraisals when completed and, in connection therewith, the Parties and their appraisers shall confer in an attempt to agree upon the fair market value of the Facility.

**(c)** If, within thirty (30) Days after completion of both appraisals, the Parties cannot agree on a fair market value for the Facility, within ten (10) Days thereafter the first two appraisers shall by mutual consent choose a third independent appraiser. If the first two appraisers fail to agree upon a third appraiser, such appointment shall be made by DPR upon application of either Party. The Parties shall direct the third appraiser (i) to select one of the appraisals generated by the first two appraisers as the Appraised Fair Market Value of the Facility (without compromise, aka "baseball" arbitration), and (ii) to complete his or her work within one month following his or her retention. If the third appraiser selects the appraisal originally generated by Seller's appraiser, Company shall pay the fees and costs of the third appraiser. If the third appraiser selects the appraisal originally generated by Company's appraiser, Seller

shall pay the fees and costs of the third appraiser and shall pay or reimburse Company for the costs of Seller's original appraiser.

(d) The “**Appraised Fair Market Value of the Facility**” means the fair market value determined by appraisal pursuant to **Section 3(a)** or **Section 3(c)** of this **Attachment P** (Sale of Facility by Seller) as applicable.

**4. Purchase and Sale Agreement.** The purchase and sale agreement (“**PSA**”) concluded by the Parties pursuant to this **Attachment P** (Sale of Facility by Seller) (as applicable) shall contain, among other provisions, the following:

(a) Seller shall, as of the closing of the sale, convey title to the Facility consistent with the state of title in existence as of the date of execution of the PSA, including all rights of Seller in the Facility or relating thereto, free and clear of all liens, claims, encumbrances, or rights of others, except any Permitted Lien;

(b) To the extent assignable or transferrable, Seller shall assign or transfer to Company all of Seller's interest in all Project Documents and Governmental Approvals that are then in effect and that are utilized for the operation or maintenance of the Facility;

(c) Seller shall execute and deliver to Company such deeds, bills of sale, assignments and other documentation as Company may reasonably request to convey title to the Facility consistent with the state of title in existence as of the date of execution of the PSA, free from all liens, claims, encumbrances, or rights of others, except any Permitted Lien;

(d) Seller shall cause all liens on the Facility for monies owed (including liens arising from Financing Documents), and any liens in favor of Seller's affiliates, to be released prior to closing on the sale of the Facility to Company;

(e) Seller shall warrant, as of the date of the closing of the sale of the Facility to Company, title to the Facility consistent with the state of title in existence as of the date of execution of the PSA, is free and clear of all other liens, claims, encumbrances and rights of others, except any Permitted Lien;

(f) Company shall have no liability for damages (including without limitation, any development and/or investment losses, liabilities or damages, and other liabilities to third parties) incurred by Seller on account of Company's purchase of the Facility, nor any other obligation to Seller except for the purchase price, and Seller shall indemnify Company against any such losses, liabilities or damages;

(g) Company shall assume all of Seller's obligations with respect to the Facility accruing from and after the date of closing on the sale of the Facility to Company, including (i) to the extent assignable, all permits held by, for, or related to the Facility, and (ii) all of Seller's agreements with respect to the Facility provided to and approved by Company at least thirty (30) Days prior to the date of closing on the sale of the Facility to Company, except for such agreements Company has elected to terminate, in which case any related termination expenses shall be, at Company's option, paid directly by Company and deducted from the purchase price;

**(h)** Seller shall indemnify Company against all of Seller's obligations with respect to the Facility accruing through the date of closing the sale of the Facility to Company, and Company shall indemnify Seller against all of Company's obligations with respect to the Facility accruing from and after the date of closing on the sale of the Facility to Company;

**(i)** Unless otherwise agreed to by the Parties, Seller makes no representations or warranties with respect to the condition of the Facility, and Company shall purchase the Facility on an as-is basis;

**(j)** Seller shall warrant that, except as disclosed to and approved by Company in writing at least thirty (30) Days prior to the date of closing on the sale of the Facility to Company, the Facility has been operated by Seller in conformity with all Laws;

**(k)** Seller shall warrant that Seller provided full access to Company and each appraiser in connection with the procedure to determine fair market value provided in **Section 3** (Procedure to Determine Fair Market Value of the Facility) of this **Attachment P** (Sale of Facility by Seller);

**(l)** If applicable, Seller's lease of the Site from Company will terminate and Seller will relinquish all rights, privileges and obligations relating to such lease; and

**(m)** Seller shall maintain the Facility in accordance with Good Engineering and Operating Practices between appraisal and the closing date.

As used in this **Attachment P** (Sale of Facility by Seller), "**Permitted Lien**" shall mean (i) any lien for taxes not yet due or delinquent or being contested in good faith by appropriate proceedings, (ii) any lien arising in the ordinary course of business by operation of applicable Laws with respect to a liability not yet due or delinquent or that is being contested in good faith, (iii) all matters that are disclosed (whether or not subsequently deleted or endorsed over) on any survey, in the title policies insuring any Land Rights or in any title commitments, title reports or other title materials, (iv) any matters that would be disclosed by a complete and correct survey of the Site, (v) zoning, planning, and other similar limitations and restrictions, and all rights of any Governmental Authority to regulate the Site and/or the Facility, (vi) all matters of record, (vii) any lien that is released on or prior to closing of the sale of the Facility to Company, (viii) statutory or common law liens in favor of carriers, warehousemen, mechanics and materialmen, and statutory or common law liens to secure claims for labor, materials or supplies arising in the ordinary course of business which are not delinquent, and (ix) the matters agreed by the Parties, to the extent that such Permitted Liens are taken into account at arriving at the appraised value.

**5. PUC Approval.** Any purchase and sale agreement related to the Facility entered into by the Parties is subject to approval by the PUC and the Parties' respective obligations thereunder are conditioned upon receipt of such approval, except as specifically provided otherwise therein.

**(a)** Company shall submit the purchase and sale agreement to the PUC for approval promptly after execution by both Parties, but Company does not extend any

assurances that PUC approval will be obtained. Seller will provide reasonable cooperation to expedite obtaining an approval order from the PUC, including providing information requested by the PUC and parties to the PUC proceeding in which approval is being sought. Seller understands that lack of cooperation may result in Company's inability to file an application with the PUC and/or failure to receive PUC approval. Unless otherwise agreed to in writing by the Parties, neither Company nor Seller shall seek reconsideration, appeal, or other administrative or judicial review of any unfavorable PUC order. The Parties agree that neither Party has control over whether or not a PUC approval order will be issued and each Party hereby assumes any and all risk arising from, or relating in any way to, the inability to obtain a satisfactory PUC order and hereby releases the other Party from any and all claims relating thereto.

**(b)** Seller shall seek participation without intervention in the PUC docket for approval of the purchase and sale agreement pursuant to applicable rules and orders of the PUC. The scope of Seller's participation shall be determined by the PUC. However, Seller expressly agrees to seek participation for the limited purpose and only to the extent necessary to assist the PUC in making an informed decision regarding the approval of the purchase and sale agreement. If the Seller chooses not to seek participation in the docket, then Seller expressly agrees and knowingly waives the right to claim, before the PUC, in any court, arbitration or other proceeding, that the information submitted and the application requesting the PUC approval are insufficient to meet Company's burden of justifying that the terms of the purchase and sale agreement are just and reasonable and in the public interest, or otherwise deficient in any manner for purposes of supporting the PUC's approval of the purchase and sale agreement. Seller shall not seek in the docket and Company shall not disclose any confidential information to Seller that would provide Seller with an unfair business advantage or would otherwise harm the position of others with respect to their ability to compete on equal and fair terms.

**(c)** In order to constitute an approval order from the PUC under this **Section 5** (PUC Approval) of this **Attachment P** (Sale of Facility by Seller), the order must approve the purchase and sale agreement, Company's funding arrangements and Company's acquisition of the Facility, shall not contain any terms and conditions deemed to be unacceptable by Company, and be in a form deemed reasonable by Company in its sole, but non-arbitrary, discretion.

**(d)** The Final Non-Appealable Order from the PUC must be obtained within six (6) months of the submission of the purchase and sale agreement to the PUC, or any extension of such period as agreed by the Parties in writing within ten (10) Days of the expiration of the six (6) month period; provided, however, that if the purchase and sale agreement governs a sale of the Facility executed pursuant to **Section 23.5** (Consolidation) of this Agreement, the Final Non-Appealable Order must be obtained within twelve (12) months of the submission of the purchase and agreement to the PUC, or any extension of such period as agreed by the Parties in writing within ten (10) Days of the expiration of the twelve (12) month period. The term "**Final Non-Appealable Order from the PUC**" means an Approval Order from the PUC (i) that is not subject to appeal to any Circuit Court of the State of Hawai'i, Intermediate Court of Appeals of the State of Hawai'i, or the Supreme Court of the State of Hawai'i, because the period permitted for such an appeal has passed without the filing of

notice of such an appeal, or (ii) that was affirmed on appeal to any Circuit Court of the State of Hawai'i, Intermediate Court of Appeals of the State of Hawai'i, or the Supreme Court of the State of Hawai'i, or was affirmed upon further appeal or appellate process, and that is not subject to further appeal, because the jurisdictional time permitted for such an appeal and/or further appellate process such as a motion for reconsideration or an application for writ of certiorari has passed without the filing of notice of such an appeal or the filing for further appellate process. Such Final Non-Appealable Order from the PUC shall constitute and be referred to as "**PUC Approval**" for purposes of this **Attachment P** (Sale of Facility by Seller).

(e) If a Final Non-Appealable Order from the PUC has not been obtained prior to the deadline provided in **Section 5(b)** of this **Attachment P** (Sale of Facility by Seller), either Party may give written notice to the other Party that it does not wish to proceed further with a sale of the Facility to Company.

(f) If the Final Non-Appealable Order from the PUC does not satisfy the conditions set forth in **Section 5(a)** of this **Attachment P** (Sale of Facility by Seller), either (i) the Parties may agree to renegotiate and submit a revised purchase and sale agreement to the PUC, or (ii) either Party may give written notice to the other Party that it does not wish to proceed further with a sale of the Facility to Company.

**6. Make Whole Amount.** For purposes of **Section 23.5** (Consolidation) the "**Make Whole Amount**" shall be equal to the sum of the following: (a) Seller's book value (including depreciation on a [fifteen (15)] year straight line basis) of all actual verifiable costs of studies, designs, engineering, and construction of the Facility, including cancellation charges and other costs of unwinding construction and demobilization if the determination is made prior to the Commercial Operations Date, (b) Seller's book value of all actual verifiable costs and expenses acquiring real estate rights for the Facility and Interconnection Facilities, (c) Seller's book value of all actual verifiable costs and expenses incurred in obtaining Governmental Approvals, (d) Seller's book value of all actual verifiable costs of financing the Facility and the Interconnection Facilities, including fees and expenses of bankers, consultants and counsel, and any discounts or premiums paid in connection with any financing, (e) any actual verifiable costs of repaying any financing in connection with a sale, including prepayment penalties or premiums, make whole payments, minimum interest payments, breakage fees, payments on account of taxes, duties and other costs, and other costs of unwinding swaps or other hedges, (f) other breakage, make whole or indemnity payments arising as the result of Company's purchase of the Facility, (g) tax costs, including recapture of federal or state tax credits and payment of transfer taxes, and (h) interest on the foregoing amounts at annual rate equal to the Prime Rate plus two percent (2%) as in effect from time to time from the date incurred through the date of payment, with all such costs being demonstrated by Seller with support and verified by Company. The items described in clauses (e), (f) and (g) (and clause (h) to the extent applicable to clauses (e), (f) and/or (g)) are referred to as the "**Financial Termination Cost.**"

## **ATTACHMENT Q** **REQUIRED INSURANCE**

(See also **Article 21** (Insurance))

**1. Worker's Compensation and Employers' Liability.** This coverage shall include Worker's Compensation, Temporary Disability and other similar insurance required by applicable State or U.S. federal laws. If exposure exists, coverage required by the Longshore and Harbor Worker's Compensation Act (33 U.S.C. § 688) shall be included. Employers' Liability coverage limits shall be no less than:

Bodily Injury by Accident - \$1,000,000 each Accident

Bodily Injury by Disease - \$1,000,000 each Employee

Bodily Injury by Disease - \$1,000,000 policy limit

**2. General Liability Insurance.**

**(a)** This coverage shall include Commercial General Liability Insurance or the reasonable equivalent thereof, covering all operations by or on behalf of Seller. Such coverage shall provide insurance for bodily injury and property damage liability for the minimum limits of liability indicated below and shall include coverage for:

- (i)** Premises, operations, and mobile equipment,
- (ii)** Products and completed operations,
- (iii)** Claims resulting from alleged damage to the environment and damage or injury caused by hazardous conditions or hazardous materials to the extent such coverage is appropriate and available at a commercially reasonable cost,
- (iv)** Blanket contractual liability,
- (v)** Broad form property damage (including completed operations),
- (vi)** Explosion, collapse and underground hazard, and
- (vii)** Personal injury liability.

**(b)** Limits of liability for Bodily Injury & Property Damage shall be:

- (i)** \$10,000,000 combined single limit per occurrence and;
- (ii)** \$20,000,000 aggregate annually.

**(c)** Coverage limits may be satisfied using Umbrella and/or Excess Liability insurance policies.

**3. Automobile Liability Insurance.** This insurance shall include coverage for owned, leased and non-owned automobiles. The minimum limits of liability shall be a combined single limit for bodily injury and property damage of Two Million Dollars (\$2,000,000) for each occurrence and in the aggregate annually. The policy shall be endorsed to include Transportation Pollution Liability insurance, covering hazardous materials to be transported by Seller, as appropriate.

**4. Builders All Risk Insurance.** This insurance shall include but not be limited to coverage for wind including named windstorm, earthquake, flood, perils, property in transit (excluding ocean transit), off-site storage - property in temporary storage or assembly away from the project site, testing, covering all materials, equipment, machinery and supplies of any nature whatsoever, the property of the Seller or of others for which the Seller may have assumed responsibility, used or to be used in or incidental to the site preparation, demolition of existing structures, erection and/or fabrication and/or reconstruction and/or repair of the project insured, including temporary works (all scaffolding, formworks, fences, shoring, hoarding, false work and temporary buildings and all incidental to the project) from the start of construction through the earlier of the Commercial Operations Date or the effective date of the policy coverage set forth in **Section 5** (All Risk Property/Mechanical and Electrical Breakdown Insurance (Upon Completion of Construction)) of this **Attachment Q** (Required Insurance). The amount of coverage shall be purchased on a full replacement cost basis, except for named windstorm, earthquake, and flood perils which shall be provided as sublimits and aggregate limits supported by a Probable Maximum Loss (PML) study and/or Catastrophe (CAT) Modeling report, if such insurance amounts are appropriate and available on commercially reasonable terms. The coverage shall be written on an "All Risks" completed value form and may allow for reasonable other sublimits for transit and for incidental offsite storage. Coverage shall be extended to include testing. Such policies shall be endorsed to require that the coverage afforded shall not be canceled (except for nonpayment of premiums) or reduced without at least thirty (30) Days' prior written notice to Seller and Company; provided, however, that such endorsement shall provide (a) that the insurer may not cancel the coverage for non-payment of premium without giving Seller and Company ten (10) Days' notice that Seller has failed to make timely payment thereof, and (b) that, subject to the consent of the Facility Lender, Seller or Company shall thereupon have the right to pay such premium directly to the insurer.

**5. All Risk Property/Mechanical and Electrical Breakdown Insurance (Upon Completion of Construction).** This insurance shall provide All Risk Property Coverage (including the perils of wind including named windstorm, earthquake, and flood) and Mechanical and Electrical Breakdown Coverage against damage to the Facility. The amount of coverage shall be purchased on a full replacement cost basis (no coinsurance shall apply) except for named windstorm, earthquake, and flood perils which shall be provided as sublimits and aggregate limits supported by a Probable Maximum Loss (PML) study and/or Catastrophe (CAT) Modeling report, if such insurance amounts are appropriate and available on commercially reasonable terms. Such coverage may allow for other reasonable sublimits. Such policies shall be endorsed to require that the coverage afforded shall not be canceled (except for nonpayment of premiums) or reduced without at least thirty (30) Days' prior written notice to Seller and Company; provided, however, that such endorsement shall provide (a) that the insurer may not cancel the coverage for non-payment of premium without

giving Seller and Company ten (10) Days' notice that Seller has failed to make timely payment thereof, and (b) that, subject to the consent of the Facility Lender, Seller or Company shall thereupon have the right to pay such premium directly to the insurer.

**6. Business Interruption Insurance (Upon Completion of Construction).** This insurance shall provide coverage for all of Seller's costs to the extent that they would not be eliminated or reduced by the failure of the Facility to operate for a period of at least twelve (12) months following a covered physical damage loss deductible period or reasonable dollar deductible or waiting period.

**7. Project Liability Errors and Omissions.** Seller shall obtain adequate protection against project liability errors and omissions on account of negligent actions or inactions of architects, engineers, contractors and subcontractors involved in the design and/or construction of the Facility.

**8. Ocean Transit.** Seller shall take reasonable action to ensure that the risk of loss or damage to any material items of equipment which are subject to ocean transit is adequately protected against by the terms of delivery from contractors or suppliers of such equipment or Seller's own insurance coverage.

**9. Pollution Liability Insurance.** This insurance shall provide coverage for losses involving hazardous material(s) and caused by pollution incidents or conditions that arise from the Facility, including but not limited to, coverage for bodily injury, sickness, disease, mental anguish or shock sustained by any person, including death, property damage including the resulting loss of use thereof, clean-up costs, and the loss of use of tangible property that has not been physically damaged or destroyed, and defense costs. The coverage must be maintained for a period of not less than three (3) years after this Agreement terminates, or the policy must provide for a supplemental extended reporting period of not less than three (3) years after this Agreement terminates. Such policy shall have minimum limits of \$5,000,000 each occurrence; and \$5,000,000 annual aggregate.

**10. Cybersecurity Insurance.** This insurance shall provide coverage for losses arising out of cyber and network risks such as data/security breach response, network interruption, data restoration, and cyber extortion. Such policy shall have minimum limits of Five Million Dollars (\$5,000,000) for each occurrence and Five Million Dollars (\$5,000,000) in policy aggregate.



**ATTACHMENT R**  
**FORM OF MONTHLY PROGRESS REPORT**

**1. Instructions**

Any capitalized terms used in this report which are not defined herein shall have the meaning ascribed to them in the Energy Storage Services Agreement by and between \_\_\_\_\_, a **[Delaware limited liability company]** (“**Seller**”), and Hawai‘i Electric Light Company, Inc., a Hawai‘i corporation, dated \_\_\_\_\_, 20\_\_\_\_ (the “**Agreement**”).

In addition to the remedial action plan requirement set forth in **Article 11** (Construction Period and Milestones) of the Agreement, Seller shall review the status of each Construction Milestone of the construction schedule (the “**Schedule**”) for the Facility and identify such matters referenced in clauses (a)-(e) below as known to Seller and which in Seller’s reasonable judgment are expected to adversely affect the Schedule, and with respect to any such matters, shall state the actions which Seller intends to take to ensure that the Construction Milestones will be attained by their required dates. Such matters may include, but shall not be limited to:

**(a)** Any material matter or issue arising in connection with a Government Approval, or compliance therewith, with respect to which there is an actual or threatened dispute over the interpretation of a law, actual or threatened opposition to the granting of a necessary Governmental Approvals, any organized public opposition, any action or expenditure required for compliance or obtaining approval that Seller is unwilling to take or make, or in each case which could reasonably be expected to materially threaten or prevent financing of the Facility, attaining any Construction Milestone, or obtaining any contemplated agreements with other parties which are necessary for attaining any Construction Milestone or which otherwise reasonably could be expected to materially threaten Seller's ability to attain any Construction Milestone.

**(b)** Any development or event in the financial markets or the independent power industry, any change in taxation or accounting standards or practices or in Seller's business or prospects which reasonably could be expected to materially threaten financing of the Facility, attainment of any Construction Milestone or materially threaten any contemplated agreements with other parties which are necessary for attaining any Construction Milestone or could otherwise reasonably be expected to materially threaten Seller's ability to attain any Construction Milestone;

**(c)** A change in, or discovery by Seller of, any legal or regulatory requirement which would reasonably be expected to materially threaten Seller's ability to attain any Construction Milestone;

**(d)** Any material change in the Seller’s schedule for initiating or completing any material aspect of the Facility;

**(e)** The status of any matter or issue identified as outstanding in any prior Monthly Progress Report and any material change in the Seller’s proposed actions to remedy or overcome such matter or issue.

## **2. Executive Summary**

### **2.1 Major activities completed**

Please provide a cumulative summary of the major activities completed for each of the following aspects of the Facility (provide details in subsequent sections of this report):

- 2.1.1 **[Insert Construction Milestones from Attachment K and Attachment L, if needed]**
- 1.1.2 Financing
- 2.1.3 Governmental Approvals for Development
- 2.1.4 Site Control
- 2.1.5 Design and Engineering
- 2.1.6 Major Equipment Procurement
- 2.1.7 Construction
- 2.1.8 Interconnection
- 2.1.9 Startup Testing and Commissioning

### **2.2. Major activities recently performed**

Please provide a summary of the major activities performed for each of the following aspects of the Facility since the previous report (provide details in subsequent sections of this report):

- 2.2.1 **[Insert Construction Milestones from Attachment K and Attachment L, if needed]**
- 2.2.2 Financing
- 2.2.3 Development Permits
- 2.2.4 Site Control
- 2.2.5 Design and Engineering
- 2.2.6 Major Equipment Procurement
- 2.2.7 Construction
- 2.2.8 Interconnection
- 2.2.9 Startup Testing and Commissioning

### **2.3 Major activities planned but not completed**

Please provide a summary of the major activities that were planned to be performed since the previous report but not completed as scheduled, including the reasons for not completing the activities, for each of the following aspects of the Facility:

- 2.3.1 **[Insert Construction Milestones from Attachment K and Attachment L, if needed]**
- 2.3.2 Financing
- 2.3.3 Governmental Approvals for Development
- 2.3.4 Site Control
- 2.3.5 Design and Engineering
- 2.3.6 Major Equipment procurement
- 2.3.7 Construction
- 2.3.8 Interconnection
- 2.3.9 Startup Testing and Commissioning

### **2.4 Major activities expected during the current month**

Please provide a summary of the major activities to be performed during the current month for each of the following aspects of the Facility (provide details in subsequent sections of this report):

- 2.4.1 Construction Milestones
- 2.4.2 Financing
- 2.4.3 Governmental Approvals
- 2.4.4 Site Control
- 2.4.5 Design and Engineering
- 2.4.6 Major Equipment procurement
- 2.4.7 Construction
- 2.4.8 Interconnection
- 2.4.9 Startup Testing and Commissioning

**3. Milestones**

**3.1 Milestone schedule**

Please list all Construction Milestones specified in **Attachment K** and state the current status of each.

<b>Construction Milestone</b>	<b>Milestone Date Specified in the Agreement</b>	<b>Status</b> (e.g., on schedule, delayed due to [ <i>specify reason</i> ]; current expected completion date)
-------------------------------	--	--

**3.2 Remedial Action Plan (if applicable)**

Provide a detailed description of Seller’s course of action and plan to achieve the missed Construction Milestones and all subsequent Construction Milestones by the Guaranteed Commercial Operations Date using the outline provided below.

- 3.2.1 Identify Missed Construction Milestone
- 3.2.2 Explain plans to achieve missed Construction Milestone
- 3.2.3 Explain plans to achieve subsequent Construction Milestones
- 3.2.4 Identify and discuss (a) delays in engineering schedule, equipment procurement, and construction and interconnection schedule and (b) plans to remedy delays as a result of the missed Construction Milestones

**4. Financing**

Please provide the schedule Seller intends to follow to obtain financing for the Facility. Include information about each stage of financing.

<b>Activity</b> (e.g., obtain \$xx for yy stage from zz)	<b>Completion Date</b>
	__/__/____ (expected / actual)
	__/__/____ (expected / actual)

**5. Project Schedule**

Please provide a copy of the current version of the overall Facility schedule (e.g., Work Breakdown Structure, Gantt chart, MS Project report, etc.). Include all major activities for Governmental Approvals for development, design and engineering, procurement, construction, interconnection and testing.

**6. Governmental Approvals**

**6.1 Environmental Impact Review**

Please provide information about the primary environmental impact review for the Facility. Indicate whether dates are expected or actual.

**Agency**

**Date of application/submission**                    \_\_\_/\_\_\_/\_\_\_ (expected / actual)

**Date application/submission deemed complete by agency**                    \_\_\_/\_\_\_/\_\_\_ (expected / actual)

**Date of initial study** (if applicable)                    \_\_\_/\_\_\_/\_\_\_ (expected / actual)

**Process** (e.g., Notice of Exemption, Negative Declaration, Mitigated Negative Declaration, Environmental Impact Report)

**Date of Notice of Preparation**                    \_\_\_/\_\_\_/\_\_\_ (expected / actual)

**Date of Draft ND/MND/EIR**                    \_\_\_/\_\_\_/\_\_\_ (expected / actual)

**Date Notice of Determination filed at OPR or County Clerk**                    \_\_\_/\_\_\_/\_\_\_ (expected / actual)

**Governmental Approvals**

Please describe each of the Governmental Approvals to be obtained by Seller and the status of each:

<b>Agency / Approval</b>	<b>Status Summary</b> e.g., dates of application / hearing / notice / etc. (note whether dates are anticipated or actual); major activities (indicate whether planned, in progress and/or completed); primary reasons for possible delay, etc.
--------------------------	---

**6.3 Governmental Approval activities recently performed**

Please list all Governmental Approval activities that occurred since the previous report.

**6.4 Governmental Approval activities expected during the current month**

Please list all Governmental Approval activities that are expected to occur during the current month.

**6.5 Governmental Approval Notices received from EPC Contractor**

Please attach to this Monthly Progress Report copies of any notices related to

Governmental Approval activities received since the previous report, whether from EPC Contractor or directly from Governmental Authorities.

**7. Site Control**

**7.1 Table of Site Control schedule**

If not obtained prior to execution of the Agreement, please provide the schedule Seller intends to follow to obtain control of the Site (e.g., purchase, lease).

Activity	Completion Date
	__/__/____ (expected / actual)
	__/__/____ (expected / actual)

**7.2 Site Control activities recently performed**

Please explain in detail the property acquisition activities that were performed since the previous report.

**7.3 Site Control activities expected during the current month**

Please explain in detail the site control activities that are expected to be performed during the current month.

**8. Design and Engineering**

**8.1 Design and engineering schedule**

Please provide the name of the EPC Contractor, the date of execution of the EPC Contract, and the date of issuance of a full notice to proceed (or equivalent).

Please list all major design and engineering activities, both planned and completed, to be performed by Seller and the EPC Contractor.

Name of EPC Contractor / Subcontractor	Activity	Completion Date
		__/__/____ (expected / actual)
		__/__/____ (expected / actual)

**8.2 Design and engineering activities recently performed**

Please explain in detail the design and engineering activities that were performed since the previous report.

**8.3 Design and engineering activities expected during the current month**

Please explain in detail the design and engineering activities that are expected to be performed during the current month.

**9. Major Equipment Procurement**

**9.1 Major equipment to be procured**

Please list all major equipment to be procured by Seller or the EPC Contractor:

<b>Equipment Description</b>	<b>Manufacturer</b>	<b>Delivery Date</b> (indicate whether expected or actual)	<b>Installation Date</b> (indicate whether expected or actual)
		__/__/____ (expected / actual)	__/__/____ (expected / actual)
		__/__/____ (expected / actual)	__/__/____ (expected / actual)

<b>Equipment Description</b>	<b>No. Ordered</b>	<b>No. Made</b>	<b>No. On-Site</b>	<b>No. Installed</b>	<b>No. Tested</b>

**9.2 Major Equipment procurement activities recently performed**

Please explain in detail the major equipment procurement activities that were performed since the previous report.

**9.3 Major Equipment procurement activities expected during the current month**

Please explain in detail the major equipment procurement activities that are expected to be performed during the current month.

**10. Construction**

**10.1 Construction activities**

Please list all major construction activities, both planned and completed, to be performed by Seller or the EPC Contractor.

<b>Activity</b>	<b>EPC Contractor / Subcontractor</b>	<b>Completion Date</b>
		__/__/____ (expected / actual)
		__/__/____ (expected / actual)

**10.2 Construction activities recently performed**

Please explain in detail the construction activities that were performed since the previous report.

**10.3 Construction activities expected during the current month**

Please explain in detail the construction activities are expected to be performed during the current month.

**10.4 EPC Contractor Monthly Construction Progress Report**

Please attach a copy of the Monthly Progress Reports received since the previous report from the EPC Contractor pursuant to the construction contract between Seller and EPC Contractor, certified by the EPC Contractor as being true and correct as of the date issued.

**11. Interconnection**

**11.1 Interconnection activities**

Please list all major interconnection activities, both planned and completed, to be performed by Seller or the EPC Contractor.

Activity	Name of EPC Contractor / Subcontractor	Completion Date
		__/__/____ (expected / actual)
		__/__/____ (expected / actual)

**11.2 Interconnection activities recently performed**

Please explain in detail the interconnection activities that were performed since the previous report.

**11.3 Interconnection activities expected during the current month**

Please explain in detail the interconnection activities that are expected to be performed during the current month.

**12. Startup Testing and Commissioning**

**12.1 Startup testing and commissioning activities**

Please list all major startup testing and commissioning activities, both planned and completed, to be performed by Seller or the EPC Contractor.

Activity	Name of EPC Contractor / Subcontractor	Completion Date
		__/__/____ (expected / actual)
		__/__/____ (expected / actual)

**12.2 Startup testing and commissioning activities recently performed**

Please explain in detail the startup testing and commissioning activities that were performed since the previous report.

**12.3 Startup testing and commissioning activities expected during the current month**

Please explain in detail the startup testing and commissioning activities that are



expected to be performed during the current month.

**13. Safety and Health Reports**

**13.1 Accidents**

Please describe all Facility-related accidents reported since the previous report.

**13.2 Work stoppages**

Please describe all Facility-related work stoppages from that occurred since the previous report, and the effect of work stoppages on the Facility schedule.

**14. Community Outreach**

Please describe all community outreach efforts undertaken since the last report.

**15. Certification**

I, \_\_\_\_\_, on behalf of and as an authorized representative of [\_\_\_\_\_], do hereby certify that any and all information contained in this Seller's Monthly Progress Report is true and accurate, and reflects, to the best of my knowledge, the current status of the construction of the Facility as of the date specified below.

By: \_\_\_\_\_

Name: \_\_\_\_\_

Title: \_\_\_\_\_

Date: \_\_\_\_\_

**ATTACHMENT S**  
**MONTHLY REPORTING AND DISPUTE RESOLUTION BY**  
**INDEPENDENT EVALUATOR**

**1. Monthly Report.** Commencing with the month during which the Commercial Operations Date is achieved, and for each calendar month thereafter during the Term, Seller shall provide to Company a Monthly Report in Excel, Lotus or such other format as Company may require, which Monthly Report shall include (a) the data for the calendar month in question populated into the form of “Monthly Report” below; and (b) Seller’s calculations of the Performance Levels and any liquidated damages assessments for the calendar month in question and the Measurement Period ending with such calendar month as set forth below. Seller shall deliver such Monthly Report to Company by the tenth (10<sup>th</sup>) Business Day following the close of the calendar month in question. Seller shall deliver the Monthly Report electronically to the address provided by the Company. Company shall have the right to verify all data set forth in the Monthly Report by inspecting measurement instruments and reviewing Facility operating records. Upon Company's request, Seller shall promptly provide to Company any additional data and supporting documentation necessary for Company to audit and verify any matters in the Monthly Report.

**MONTHLY REPORT**

NAME OF IPP FACILITY: [Facility Name]

MONTHLY REPORT PERIOD: [Month Day, Year] to [Month Day, Year]

Enter the applicable information from operational data collected during the most recently completed Capacity Test to demonstrate achievement of the Performance Level Rated Energy Capacity during the reporting period.

Date/Time Start	Date/Time End	Total MWh delivered to the POI (A)	Contract Capacity (MWh) (B)	Capacity Ratio 100% x (A ÷ B)

Enter the applicable information from operational data collected during the most recently completed RTE Test to demonstrate achievement of the Performance Level RTE during the reporting period.

Date/Time Start	Date/Time End	Total MWh delivered to the POI (A)	Charging Energy (MWh) (B)	RTE Ratio 100% x (A ÷ B)

Enter the information for each Force Majeure event affecting the Facility during the reporting period. Dates and times should be entered to the nearest minute. Duration, size of reduction, rated active power capacity, and equivalent hours should be rounded to 1 decimal place.

Date/Time Start (A)	Date/Time End (B)	Duration (hrs) (C) = (B - A)	Size of Reduction (MW) (D)	Rated Active Power Capacity (MW) (E)	Equivalent Hours (hrs) (C x D) ÷ E
...					

Calendar hours in the reporting period: \_\_\_\_\_

Total equivalent ExcludedTime (ET) for the reporting period (from above, with proper accounting for any simultaneous events): \_\_\_\_\_

Enter the information for each Outage during the reporting period. Dates and times should be entered to the nearest minute. Duration should be rounded to 1 decimal place.

Date/Time Start (A)	Date/Time End (B)	Duration (hrs) (B - A)
...		

Calendar hours in the reporting period: \_\_\_\_\_

Total Outage hours for the reporting period (from above): \_\_\_\_\_

Available Hours (AH) in the reporting period: \_\_\_\_\_

Enter the information for each Planned Derating event during the reporting period. Dates and times should be entered to the nearest minute. Duration, size of reduction, rated active power capacity, and equivalent hours should be rounded to 1 decimal place.

Date/Time Start (A)	Date/Time End (B)	Duration (hrs) (C) = (B - A)	Size of Reduction (MW) (D)	Rated Active Power Capacity (MW) (E)	Equivalent Hours (hrs) (C x D) ÷ E
...					

Total equivalent planned derated hours (EPDH) for the reporting period: \_\_\_\_\_

Enter the information for each Unplanned Derating event during the reporting period. Dates and times should be entered to the nearest minute. Duration, size of reduction, rated active power capacity, and equivalent hours should be rounded to 1 decimal place.

Date/Time Start (A)	Date/Time End (B)	Duration (hrs) (C) = (B - A)	Size of Reduction (MW) (D)	Rated Active Power Capacity (MW) (E)	Equivalent Hours (hrs) (C x D) ÷ E
...					

Total equivalent unplanned derated hours (EUDH) for the reporting period: \_\_\_\_\_

Enter the Available Hours, EPDH, EUDH, ET and Period Hours for the reporting period as calculated above. Period Hours is equal to the number of days in the applicable calendar month multiplied by 24 hours.

AH (A)	EPDH (B)	EUDH (C)	ET (D)	Measured Availability $100\% \times (A - B - C + D) \div PH$

**2. Monthly Report Disagreements.**

**(a) Notice of Disagreement With Monthly Report.** Within ten (10) Business Days following the close of the calendar month in question, Seller shall provide to Company the Monthly Report for such calendar month and the Measurement Period ending with such calendar month, as applicable, as provided in **Section 1** (Monthly Report) of this **Attachment S** (Monthly Reporting and Dispute Resolution by Independent Evaluator). Within ten (10) Business Days after Company’s receipt of a Monthly Report, Company shall provide written notice to Seller of any Monthly Report Disagreement, including with respect to the data for the calendar month covered by such Monthly Report and Seller’s calculation of, as applicable (i) either of the Capacity Ratio or the RTE Ratio for the Measurement Period ending with such calendar month or (ii) the Measured Availability for such calendar month (“**Notice of Disagreement**”). Together with any such Notice of Disagreement, the Company shall include its own calculations and other support for its position. If Company fails to provide a Notice of Disagreement within said 10-Business Day period, the Monthly Report provided by Seller shall be deemed to be accepted by Company and shall no longer be subject to dispute by Company or Seller.

**(b) Submission of Monthly Report Disagreement to Independent Evaluator.** Upon issuance of a Notice of Disagreement, the Parties shall review the contents of the Monthly Report(s) together with such Notice of Disagreement and attempt to resolve such Monthly Report Disagreement. If the Parties are able to agree on a resolution of any Monthly Report Disagreement, the resulting corrected Monthly Report(s) in question shall be set forth in a writing executed by both Parties, following which (i) such corrected Monthly Reports shall no longer be subject to dispute by either Party and (ii) to the extent such resolution of such Monthly Report Disagreement affects future Monthly Reports, such future Monthly Reports shall be prepared, and the Measured Availability in such future Monthly Reports shall be calculated, in a manner consistent with such resolution. If the Parties are unable to resolve such Monthly Report Disagreement within ten (10) Business Days after Company’s issuance of such Notice of Monthly Report Disagreement, either Party may, within five (5) Business Days after the end of such 10-Business Day period, submit the unresolved Monthly Report Disagreement to an Independent Evaluator for resolution.

**(c) Appointment of Independent Evaluator.** If either Party decides to submit an unresolved Monthly Report Disagreement to an Independent Evaluator, it

shall provide written notice to that effect (the “**Submission Notice**”) to the other Party, which notice shall designate which of the engineering firms on the Consultants List is to act as the Independent Evaluator for purposes of resolving such dispute; provided, however, for purposes of facilitating consistency in the resolution of Monthly Report Disagreements, all Monthly Report Disagreements concerning the same Performance Level arising out of any one or more of the twelve (12) Monthly Reports issued for a given Contract Year shall be submitted to the same Independent Evaluator unless such Independent Evaluator declines to accept any such submission(s). A Submission Notice must be provided within the 5-Business Day period provided in **Section 2(b)** (Submission of Monthly Report Disagreement to Independent Evaluator) of this **Attachment S** (Monthly Reporting and Dispute Resolution by Independent Evaluator). The Parties shall each pay fifty percent (50%) of the fees and expenses charged by the Independent Evaluator.

**(d) Eligibility for Appointment as Independent Evaluator.** Both Parties agree that the engineering firms listed in **Attachment D** (Consultants List) are fully qualified to serve as Independent Evaluator. By mutual agreement between the Parties in writing, a name or names may be added to or removed from the OEPR Consultants List at any time. In no event shall there be less than three (3) names on the Consultants List.

**(e) Participation of Parties.** Promptly following the issuance of a Submission Notice as provided in **Section 2(c)** (Appointment of Independent Evaluator) of this **Attachment S** (Monthly Reporting and Dispute Resolution by Independent Evaluator), Seller and Company shall provide the Independent Evaluator which such data as they consider to be material to the resolution of the disputed issue(s). Seller and Company shall also provide such additional data and information as the Independent Evaluator may reasonably request. The Parties shall assist the Independent Evaluator throughout the process of resolving such dispute, including making key personnel and records available to the Independent Evaluator, but neither Party shall be entitled to participate in any meetings with personnel of the other Party or review of the other Party's records. However, the Independent Evaluator will have the right to conduct meetings, hearing or oral arguments in which both Parties are represented.

**(f) Written Decision of Independent Evaluator.** The terms of engagement with the Independent Evaluator shall require the Independent Evaluator to issue its written decision resolving the disputed issues submitted to it within the applicable time period set forth below, which time periods are subject to any tolling that may be applicable pursuant to **Section 2(g)** (Sequence to Resolving Interrelated Disagreements) of this **Attachment S** (Monthly Reporting and Dispute Resolution by Independent Evaluator): (a) 30 Days as measured from the issuance of the Submission Notice; or (b) such other time period as the Parties may agree in writing. Unless otherwise agreed by the Parties in writing:

**(i)** for a Monthly Report Disagreement concerning the Capacity Ratio or the RTE Ratio, the written decision of the Independent Evaluator shall set forth the Capacity Ratio and/or RTE Ratio (as applicable) for the Measurement Period in question, as applicable; and

**(ii)** for a Monthly Report Disagreement concerning the Measured Availability, the written decision of the Independent Evaluator shall set forth (aa) the correct values to be used for AH, EPDH, EUDH and PH under **Attachment U** (Measured Availability) for the calendar month in question if any such values were in dispute and (bb) the Measured Availability for such calendar month in question if such Measured Availability was in dispute.

**(g) Sequence for Resolving Interrelated Disagreements.** If at the time a Monthly Report Disagreement is submitted to an Independent Evaluator pursuant to **Section 2(c)** (Appointment of Independent Evaluator) of this **Attachment S** (Monthly Reporting and Dispute Resolution by Independent Evaluator) there are one or more other unresolved Monthly Report Disagreements concerning the same Performance Level and the same LD Period that are pending before a different Independent Evaluator, and the resolution of such other Monthly Report Disagreement(s) is necessary to the resolution of the Monthly Report Disagreement that has been newly submitted to a new Independent Evaluator as aforesaid, the time period for such new Independent Evaluator to issue its written decision resolving such newly submitted Monthly Report Disagreement shall be tolled until such pending Quarterly Report Disagreement(s) have been resolved. For avoidance of doubt, it is the intent of the Parties that disagreements over performance ratio data and calculations for a given calendar month shall (i) not be subject to resolution twice and (ii) once resolved, shall not be reopened.

**(h) Final, Conclusive and Binding.** The Parties acknowledge the inherent uncertainty in calculating the Performance Levels, and hereby assume the risk of such uncertainty and waive any right to dispute the qualification of the person or entity appointed as the Independent Evaluator pursuant to **Section 2(c)** (Appointment of Independent Evaluator) of this **Attachment S** (Monthly Reporting and Dispute Resolution by Independent Evaluator) and/or the appropriateness of the methodology used by Independent Evaluator in resolving such Monthly Report Disagreements. Without limitation to the generality of the preceding sentence, the decision of the Independent Evaluator as to each Monthly Report Disagreement submitted to an Independent Evaluator shall be final, conclusive and binding upon Company and Seller and shall not be subject to further dispute under **Article 26** (Dispute Resolution) of the Agreement.

**3. Periodic Review of Method of Calculating and Reporting Performance Level.** At least once per Contract Year, Company shall review the method of calculating and reporting Performance Levels under this Agreement to determine if other variables should be incorporated into such calculations. Any revisions to the Performance Level calculations in this Agreement shall be mutually agreed to by both Seller and Company.

**4. Future Changes in Reporting Requirements.** Seller shall reasonably cooperate with any Company requested revisions to the Monthly Report to include additional data that may be necessary from time to time to enable Company to comply with any new reporting requirements directed by the PUC or otherwise imposed under applicable Laws.

## **ATTACHMENT T** **CAPACITY RATIO AND RTE RATIO**

As defined and further described below:

- Prior to achieving Commercial Operations, Seller shall demonstrate: (1) through a scheduled formal Capacity Test, that the Capacity Ratio is not less than **100%**; and (2) through a scheduled formal RTE Test, that the RTE Ratio is not less than the Performance Level RTE set forth in **Section 4.2** (Performance Levels); and
- In each calendar month during Commercial Operations, unless waived by Company, Seller shall demonstrate that the Facility achieves the Performance Level Rated Energy Capacity and the Performance Level RTE.

### Performance Level Rated Energy Capacity

The Performance Level Rated Energy Capacity (a) is set forth in **Section 4.2** (Performance Levels); (b) shall be deemed “achieved” where the Capacity Ratio is not less than **100%** for an applicable calendar month; and (b) can be demonstrated through either operational data or a scheduled formal Capacity Test.

The “**Capacity Ratio**” shall be the number, expressed as a percentage, equal to the following:

$$\text{Capacity Ratio} = 100\% \times [(\text{PLREC} - \text{Measured Actual Energy Capacity}) \div \text{PLREC}]$$

Where:

PLREC = Performance Level Rated Energy Capacity, or 22 MWh

Measured Actual Energy Capacity = total Discharge Energy (MWh discharged) delivered to the Point of Interconnection to bring the Facility to a 0% State of Charge from (i) its maximum State of Charge or (ii) 100% State of Charge

A “**Capacity Test**” occurs when Company coordinates Company Dispatch/Charge to demonstrate the Facility maintains the power output required to follow the dispatch signal provided by the Company through a control setpoint, as measured at the Point of Interconnection, and is able to continuously discharge energy to the Point of Interconnection according to Company Dispatch/Charge to bring the Facility to a 0% State of Charge from (i) its maximum State of Charge or (ii) 100% State of Charge.

The Capacity Test can only be performed when the Facility is at the lower of: (i) its maximum State of Charge or (ii) 100% State of Charge prior to the start of the Capacity Test and during the Capacity Test the Company Dispatch/Charge allows for continuous discharge of the Facility to 0% State of Charge with energy delivered to the Point of Interconnection within a twenty-four (24) hour period of time. The State of Charge for the above Capacity Test refers to the percentage of Rated Energy Capacity stored in the BESS.

### Performance Level RTE

The Performance Level RTE (a) is set forth in **Section 4.2** (Performance Levels); (b) shall be deemed “achieved” where the RTE Ratio is not less than **85%** for an applicable calendar month; and (c) can be demonstrated through either operational data or a scheduled formal RTE Test.

Demonstration of the Performance Level RTE requires measurement of “Charging Energy” at the Point of Interconnection (MWh charged) to bring the Facility from a State of Charge to a 100% State of Charge from the grid according to Company Dispatch/Charge command, followed by a resting period of not less than five (5) minutes and no greater than four (4) hours, followed by measurement of the “Discharge Energy” (MWh discharged) delivered to the grid to bring the Facility to State of Charge according to Company Dispatch/Charge command. The State of Charge referenced in this paragraph refers to percentage of Rated Energy Capacity stored in the BESS.

For the purposes of evaluating the RTE Test, the “**RTE Ratio**” shall be the number, expressed as a percentage, equal to the total Discharge Energy (MWh discharged) to the Point of Interconnection during the RTE Test, divided by the “Charging Energy” (MWh charged) measured at the Point of Interconnection. For purposes of the RTE Test, the charging cycle shall begin when the Facility is at a 0% State of Charge prior to a (i) 100% discharge cycle or (ii) Capacity Test if being conducted concurrently and the Charging Energy is the amount of energy, as measured at the Point of Interconnection, that brings the Facility to a 100% State of Charge. The State of Charge for the above RTE Test refers to the percentage of Rated Energy Capacity stored in the BESS. The formula for the RTE Ratio is as follows:

$$\text{RTE Ratio} = 100\% \times (\text{Discharge Energy}) \div (\text{Charging Energy})$$

A “**RTE Test**” occurs when the Company coordinates Company Dispatch/Charge to demonstrate the charging/discharging requisite to achieve the Performance Level RTE. The RTE Test may be conducted concurrently with the Capacity Test.

### Test Procedures

Upon commencing Commercial Operations, Seller shall achieve the Performance Level Rated Energy Capacity in each Measurement Period either by reference to the operational data or by conducting a scheduled formal Capacity Test. If Seller achieves the Performance Level Rated Energy Capacity at any time during a particular Measurement Period, then Seller shall be deemed to have achieved the Performance Level Rated Energy Capacity for that entire Measurement Period.

Upon commencing Commercial Operations, Seller shall achieve the Performance Level RTE in each Measurement Period either by reference to the operational data or by conducting a scheduled formal RTE Test. If Seller achieves the Performance Level RTE at any time during a particular Measurement Period, then Seller shall be deemed to have achieved the Performance Level RTE for that entire Measurement Period.

Any Capacity Test or RTE Test (each a “**Facility Test**” and collectively, the “**Facility**



**Tests**) scheduled in lieu of being demonstrated by reference to operational data shall be performed at a time reasonably requested by the Company in its sole discretion. Company shall provide notice to Seller no less than three (3) Business Days prior to conducting a Facility Test.

If, during a Measurement Period, Seller both fails to pass a Capacity Test noticed by Company and fails to achieve the Performance Level Rated Energy Capacity by reference to operational data for such Measurement Period, the Facility shall nevertheless be deemed to have achieved the Performance Level Rated Energy Capacity for the applicable Measurement Period if Seller was unable to perform such noticed Capacity Test during such Measurement Period due to (a) conditions on the Company System other than Seller-Attributable Unavailability or (b) an act or omission by Company. If, during a Measurement Period, Seller does not achieve the Performance Level Rated Energy Capacity through operational data or a Capacity Test, the Capacity Ratio used to assess liquidated damages under **Section 4.3(a)** (Capacity and Liquidated Damages) shall be the highest demonstrated in operational data or completed Capacity Test during the applicable Measurement Period.

If, during a Measurement Period, Seller both fails to pass a RTE Test noticed by Company and fails to achieve the Performance Level RTE by reference to operational data for such Measurement Period, the Facility shall nevertheless be deemed to have achieved the Performance Level RTE for the applicable Measurement Period if Seller was unable to perform such noticed RTE Test during such Measurement Period due to (a) conditions on the Company System other than Seller-Attributable Unavailability or (b) an act or omission by Company. If, during a Measurement Period, Seller does not achieve the Performance Level RTE through operational data or a RTE Test, the RTE Ratio used to assess liquidated damages under **Section 4.5(a)** (RTE and Liquidated Damages) shall be the highest demonstrated in operational data or completed RTE Test during the applicable Measurement Period.

Company shall have the right to attend, observe and receive the results of all Facility Tests. Seller shall provide to Company the results of each Facility Test (including time stamped graphs of system performance based in operational data or test data) no later than ten (10) Business Days after the performance of such Facility Test.

## **ATTACHMENT U** **MEASURED AVAILABILITY**

To the extent the Commercial Operations Date occurs on a date other than the first day of a calendar month, the period between the Commercial Operations Date and the first (1<sup>st</sup>) day of the next calendar month if any, shall be ignored for purposes of this Measured Availability.

The Measured Availability shall be calculated as follows:

$$\text{Measured Availability} = 100\% \times \frac{AH - EDH + ET}{PH}$$

Where:

PH is period hours (24 hours × the number of days in the applicable calendar month).

Available Hours (AH) is the number of hours that the Facility is not on Outage. It is sum of all Service Hours (SH) + Reserve Shutdown Hours (RSH).

An “Outage” exists whenever the entire Facility is offline and unable to charge or discharge electric energy and is not in Reserve Shutdown state.

Service Hours (SH) is the number of hours during the applicable calendar month the Facility is online and (i) charging from the Company System or (ii) discharging electric energy to the Company System.

Reserve Shutdown Hours (RSH) is the number of hours during the applicable calendar month the Facility is available but not charging or discharging electric energy or is offline at Company’s request for reasons other than Seller-Attributable Unavailability.

A “Derating” exists when the Facility is available but at less than Rated Active Power Capacity, including deratings due to Seller-Attributable Unavailability or those by Company pursuant to **Section 12.1(b)** (Failure to Comply; Seller-Attributable Unavailability). For avoidance of doubt, if there is a Facility Outage occurring, there cannot also be a Deration.

Equivalent Derated Hours (EDH) is the sum of ESADH, EPDH, and EUDH. For deratings due to Facility inverter unavailability, the equivalent full outage hour(s) are calculated by multiplying the actual duration of the derating (hours) by the number of Facility inverters unavailable and dividing by the total number of Facility inverters. For deratings that do not impact the availability of an entire Facility inverter or set of entire Facility inverters, the equivalent full outage hour(s) are calculated by multiplying the actual duration of the derating (hours) by the size of the derating (in MW) and dividing by the Rated Active Power Capacity.

Equivalent Seller-Attributable Derated Hours (ESADH): A Seller-Attributable

Derating occurs when a derating exists due to Seller-Attributable Unavailability or deratings by Company pursuant to **Section 12.1(b)** (Failure to Comply; Seller-Attributable Unavailability). Each individual derating is transformed into equivalent full outage hour(s). These equivalent hour(s) are then summed for the applicable period.

EPDH is the equivalent planned derated hours, including Planned Deratings (PD) and Maintenance Deratings (D4). A Planned Derating is when the Facility experiences a derating scheduled well in advance and for a predetermined duration. A Maintenance Derating is a derating that can be deferred beyond the end of the next weekend (Sunday at midnight or before Sunday turns into Monday) but requires a reduction in capacity before the next Planned Derating (PD). Each individual derating is transformed into equivalent full outage hour(s). These equivalent hour(s) are then summed for the applicable calendar month.

EUDH is the equivalent unplanned derated hours. An Unplanned Derating (Forced Derating) occurs when the Facility experiences a derating that requires a reduction in availability before the end of the nearest following weekend. Each individual Unplanned Derating is transformed into equivalent full outage hour(s). These equivalent hour(s) are then summed.

Excluded Time (ET) is unavailability as a result of the entire Facility or a portion thereof being unavailable due to Force Majeure. Force Majeure that results in an Outage shall not be included in Available Hours. Force Majeure that results in a deration is to be included in EDH as its effect will be canceled by the addition of Excluded Time. Each derating event that counts as Excluded Time is transformed into equivalent full excluded hour(s) in the same manner as the EDH. These equivalent Excluded Time hour(s) are then summed and summed with the full outage hours of Excluded Time. The following examples are provided as illustrative examples only:

---

*Example A:* The Facility was continuously available, with no Outages or Deratings for the applicable 30-day calendar month. In this case AH = 720 hours, EDH = 0 hours as ESADH, EPDH and EUDH each = 0 hours

$$\text{Measured Availability} = 100\% \times \frac{720-0}{720} = 100\%$$

*Example B:* During the applicable 30-day calendar month: (a) the Facility was online and charging from or discharging electric energy to the Company System for 350 hours and was available but not charging electric energy due to lack of stored energy from the Company System (i.e., not Seller-Attributable Unavailability) for 300 hours; (b) the Facility experienced a Planned Derating of 1.25 MWs for 100 hours for maintenance that was scheduled a month in advance; (c) the Facility also experienced an Unplanned Derating of 1 Facility inverter for 125 hours as the derating could not be deferred beyond the nearest following weekend, but it was determined to be due to a Force Majeure; (d) The Facility experienced an outage due to Force Majeure for 70 hours; and (e) the Facility did not experience any outage or derating due to Seller-

Attributable Unavailability during this period.

The Rated Active Power Capacity of the Facility is 5 MW and the Facility contains 50 total inverters.

PH = 720 hours in 30-day calendar month

SH = 350 hours

RSH = 300 hours

AH = SH + RSH = 350 + 300 = 650 hours

ESADH = 0 hours

EPDH = 100 hours x (1.25 MW ÷ 5 MW) = 25 hours (Planned Maintenance)

EUDH = 125 hours x (1 inverters ÷ 5 inverters) = 25 hours (Unplanned Deration (Forced Derating)) and all these EUDH were due to Force Majeure, so they are to be added to Excluded Time.

EDH = ESADH + EPDH + EUDH = 0 hours + 25 hours + 25 hours = 50 hours

The Facility was on Outage due to Force Majeure for 70 hours.

Excluded Time = 25+70 = 95

Measured Availability =  $100\% \times \frac{650-50+95}{720} = 96.5\%$

**ATTACHMENT V  
RESERVED**

**ATTACHMENT W**  
**SUMMARY OF MAINTENANCE AND INSPECTION PERFORMED**  
**IN PRIOR CALENDAR YEAR**

(See **Article 13**)

DATE WORK ORDER SUBMITTED: 06/28/96

WO#: 11451

EQUIPMENT #: 1CCF-TNK-1

EQUIPMENT DESCRIPTION: AMMONIA STORAGE TANK 1

PROBLEM DESCRIPTION: PURCHASE EMERGENCY ADAPTER FITTINGS FOR UNLOADING GASPRO TANKS TO STORAGE TANK

WORK PERFORMED: PURCHASED THE NEW ADAPTERS AND VERIFIED THEIR OPERATION.

COMPLETION DATE: 06/28/96

WORK ORDER COMPLETED BY: AA

-----END OF CURRENT WORK ORDER-----

DATE WORK ORDER SUBMITTED: 05/19/96

WO#: 11136

EQUIPMENT #: 1WSA-BV-12

EQUIPMENT DESCRIPTION: MAKE-UP PI ISOLATION

PROGRAM DESCRIPTION: 'D' MAKE-UP PUMP PI ISOLATION FITTING LEAKING ON SPOOL SIDE

WORK PERFORMED: REMOVED AND REPLACED FITTINGS AND FLANGES WITH STAINLESS STEEL. THIS WORK WAS DONE DURING PUMP OVERHAUL ON WO 1374. JH

COMPLETION DATE: 06/28/96

WORK ORDER COMPLETED BY: BB

-----END OF CURRENT WORK ORDER-----

**[This Attachment sets forth the terms and conditions which shall apply to Seller's use the Company-controlled Site.]**

## **ATTACHMENT X**

### **COMPANY-CONTROLLED SITE**

#### **1. Description of Company-Controlled Site.**

**(a) General.** At the request of Seller, Company shall make available to Seller an area on property controlled by Company to allow performance of Seller's obligations under this Agreement, provided that Company shall make available only as much acreage as necessary for Seller's performance (the "**Company-Controlled Site**").

**(i) During Construction of the Facility.** During such time as Seller is actively constructing the Facility, the Company shall make available a reasonable area on Company's property, as determined by Company, for Seller's construction activities, which shall be no larger than \_\_\_\_\_ acres, as shown on the site plan attached as **Exhibit X.1** (Site Plan) to this **Attachment X** (Company-Controlled Site). The Company shall work with Seller to physically demarcate, at Seller's expense, the boundaries of the area that will be made available to Seller during construction of the Facility.

#### **(ii) Upon Completion of the Facility.**

**(A)** Upon Seller's completion of the Facility, Company shall make available to Seller only as much area as necessary for ongoing operation of the Facility under the terms of this Agreement. The Company shall work with Seller to physically demarcate, at Seller's expense, the boundaries of the area that will be made available to Seller for the remainder of the Term after Seller's completion of the Facility.

**(B)** Upon Seller's request during the Term of this Agreement, Company, in its sole discretion, may make available to Seller additional acreage, on a temporary basis, for Seller's maintenance, repair or replacement of the Facility, or any portion thereof, on an as-needed basis; provided, however, that the additional acreage shall not exceed the boundaries of the area shown on the site plan attached as **Exhibit X.1** (Site Plan) to this **Attachment X** (Company-Controlled Site). At any time during the Term, the actual available area that may be available to Seller for such maintenance, repair or replacements activities may change in accordance with the Company's needs and then-current utilization plans for the area, all of which the Company hereby reserves in its sole and absolute discretion.

**(b) Utilization of Site.** Seller shall utilize the Company-Controlled Site solely in connection with and for the purposes of constructing a Facility and meeting Seller's obligations to Company under this Agreement. Seller waives and relinquishes any right it may have under Title 11, United States Code, and any other or successor state or federal statute relating to assignment for the benefit of creditors, appointment of a receiver or trustee, bankruptcy, composition, insolvency, moratorium, reorganization, or similar matters ("**Bankruptcy Law**"), in any proceeding, whether

voluntary or involuntary, under any Bankruptcy Law, or otherwise to assert the Company-Controlled Site should be used for any purpose other than in connection with and for the purposes of meeting Seller's obligations under this Agreement.

**2. Security and Access to Site.**

**(a) During Construction of the Facility.**

**(i) Security.** During such time as Seller is actively constructing the Facility, Seller at its option may secure the Company-Controlled Site with fencing and gates to prevent unauthorized persons or vehicles from entering or crossing through the Company-Controlled Site and/or adjacent lands owned or operated by Company. Such fencing and gating shall require the prior written approval of the Company before erecting such fencing and gating.

**(ii) Access to Company-Controlled Site.** During such time as Seller is actively constructing the Facility, Company shall provide access to the Company-Controlled Site through a separate contractor's entrance, if available, or through other reasonable means as may be determined by Company in its sole discretion.

**(b) Upon Completion of the Facility.**

**(i) Secured Facility.** Seller shall secure the Facility on the Company-Controlled Site and prevent access to the Facility by unauthorized personnel in the same matter or higher as Company secures its power generating facilities in the county in which the Company-Controlled Site is located. Notwithstanding Company's then current security procedures for its other facilities, in the event of security concerns as may be determined by the Company's security personnel, Company may require Seller to temporarily maintain personnel at the Company-Controlled Site 24 hours a day 7 days a week to monitor the security and safety of the Company-Controlled Site and Facility.

**(ii) Limited Access to Company-Controlled Site.** Seller shall maintain barriers on the Company-Controlled Site to prevent unauthorized persons or vehicles from entering or crossing through the Company-Controlled Site and/or adjacent lands owned or operated by Company.

**(c) Personnel.** At all times during the Term of this Agreement, Seller shall conduct security and background checks on all Seller representatives, employees, independent contractors, agents, and other persons who will be allowed access to the Facility by Seller and shall require all such persons to take periodic drug tests. Seller shall not allow on the Company-Controlled Site any persons who do not pass such security checks or drug tests. Due to the critical nature of Company's operations where the Company-Controlled Site is situated, Seller agrees that if Company, in its sole discretion and after reasonable consultation with Seller, determines that the continued presence of any Seller representative, employee, contractor or agent on Company property is not consistent with the best interests of Company, then in such an instance Company may request that Seller remove such representative, employee, contractor or agent from the Company-Controlled Site and Seller shall forthwith comply with such request. Seller may replace such representative, employee,



contractor or agent with another who meets Company's standards at no additional cost to Company.

**(d) Access and Inspection.** At all times during the Term of this Agreement, Company and its agents, representatives, and designees may enter the Company-Controlled Site upon reasonable notice for any reason, including but not limited to the following: to (a) ascertain whether Seller is complying with this Agreement; (b) cure any failure of Seller to comply with this **Attachment X** (Company-Controlled Site); (c) inspect the Company-Controlled Site and any construction or improvements, including the Facility; (d) perform such tests, borings, and other analyses as Company determines may be necessary or appropriate relating to (non)compliance with any Laws or possible Hazardous Substances Discharge (hereinafter defined). Company and its designees shall not unreasonably interfere with operations of the Facility and shall comply with Seller's reasonable instructions.

### **3. Compliance**

**(a) Generally.** Seller shall, at Seller's expense, in all material respects: (i) comply with all Laws, ordinances, requirements, orders, proclamations, directives, rules, and regulations of any Governmental Authority affecting the Company-Controlled Site; (ii) comply with all rules regulating the use of and activities and conduct upon the Company's property, including the Company-Controlled Site, as may be established and amended from time to time by the Company in its sole discretion; (iii) comply with the covenants, conditions, and restrictions set forth in any documents recorded against the Company-Controlled Site; (iv) procure any and all licenses, permits (including building, demolition, alteration, use, and special permits), approvals, consents, certificates (including certificate(s) of occupancy), rulings, variances, authorizations, or amendments to any of the foregoing as shall be necessary or appropriate under any Laws to construct and operate the Facility and to perform repair, alteration, demolition, or other work affecting the Facility ("**Approvals**"); and (v) comply with all Approvals.

**(b) Notice of Inspections.** Seller shall give Company notice of any proposed inspection of the Company-Controlled Site or the Facility by any Governmental Authority immediately upon Seller's receipt of notice of such inspection.

### **4. Seller's Investigation of the Company-Controlled Site.**

**(a) Investigations and Reports.** Seller shall make such independent investigations as Seller deems necessary or appropriate concerning Seller's utilization of the Company-Controlled Site for the purposes of meeting Seller's obligations under this Agreement. Notwithstanding the foregoing, if Seller wishes to conduct an environmental or soil assessment on the Company-Controlled Site, including but not limited to any Baseline Assessment conducted under **Section 7(a)** (Baseline Assessment) of this **Attachment X** (Company-Controlled Site), Company shall select the environmental or engineering consultant to conduct the investigation and shall contract with the consultant to provide the report at Seller's cost. The provision of any such report to Seller shall be subject to the confidentiality provisions of **Section 7(l)** (Confidentiality) of this **Attachment X** (Company-Controlled Site).

**(b) Permits, Assurances, and Approvals.** Seller agrees to provide Company with copies of all permits, Approvals and assurances pertaining to Seller's construction on the Company-Controlled Site, including but not limited to building and grading permits, special management area permits, assurances from Governmental Authorities, utility commitments and service agreements, and any permits, Approvals or assurances regarding the development or use of water, roadways, utilities or other infrastructure.

**(b) Acceptance of Company-Controlled Site.** Seller acknowledges that it has, or has had the opportunity, to inspect carefully the Company-Controlled Site, and accepts the Company-Controlled Site in AS IS condition WITH ALL FAULTS. Seller further acknowledges that neither Company nor its agents or employees have made any representations or warranties of any kind whatsoever as to the suitability or fitness of the Company-Controlled Site for the construction or operation of the Facility or for any other purpose, nor has Company or its agents or employees agreed to make any repairs, undertake any alterations, or construct any improvements on or with respect to the Company-Controlled Site other than such Company-Owned Interconnection Facilities as Company has or may agree to build or install.

**(c) No Company Services.** Seller acknowledges and agrees that Company is under no obligation to provide any services such as security, water, utilities or infrastructure to the Company-Controlled Site.

## **5. Construction, Maintenance and Interference.**

**(a) Construction.** At Seller's sole cost and expense, Seller shall construct the Facility in accordance with the requirements of this Agreement. Seller shall not commence any demolition, construction, reconstruction, restoration, or other work affecting the Company-Controlled Site, including construction of the Facility ("**Construction**") until it has the applicable necessary Approvals. Prior to commencement of any Construction, Seller shall cause each entity involved in such Construction, who is a direct contractor of Seller and who has mechanic lien rights under Chapter 507 of the Hawaii Revised Statutes, to deliver to Company a performance and payment bond in a form acceptable to Company and from a surety reasonably acceptable to Company, covering the faithful performance of such entity's contract with the Seller and the payment of all obligations arising thereunder, and naming Company as an obligee. Seller shall complete Construction of the Facility within the time periods required by this Agreement. Seller shall pay for all Construction when and as required by the parties that perform such Construction. All improvements that Seller constructs on the Company-Controlled Site other than Company-Owned Interconnection Facilities shall be the property of the Seller for the Term of this Agreement.

**(b) Plans and Specifications.** Seller shall promptly provide Company with plans and specifications or surveys (including working plans and specifications and "as-built" plans and specifications and surveys) for any Construction.

**(c) Applications.** Upon Seller's request, Company shall, without cost to Company, promptly join in and execute any Application (hereinafter defined) as Seller reasonably requests, provided that: (i) such Application is in customary form and

imposes no material obligations (beyond obligations ministerial in nature or merely requiring compliance with applicable Laws) upon Company; (ii) no uncured Event of Default exists; and (iii) Seller reimburses Company's attorneys' fees and costs. Promptly upon Seller's request and without charge (except reimbursement of Company's attorneys' fees and costs), Company shall furnish all information in its possession that Seller reasonably requests for any Application. For the purposes of this **Attachment X** (Company-Controlled Site), "**Application**" shall mean any agreement, application, certificate, document, or submission (or amendment of any of the foregoing): (i) necessary or appropriate for any Construction allowed under this **Attachment X** (Company-Controlled Site), including any application for any building permit, certificate of occupancy, utility service or hookup, easement, covenant, condition, restriction, subdivision plat, or such other instrument as Seller may from time to time reasonably request for such Construction; (ii) to enable Seller from time to time to seek any Approval or to use and operate the Facility in accordance with this Agreement; or (iii) otherwise reasonably necessary and appropriate to allow Seller to meet its obligations under this **Attachment X** (Company-Controlled Site).

**(d) Obligation to Maintain.** Seller shall remove trash and debris from the Company-Controlled Site and the adjoining sidewalk, if any, and maintain them in a reasonably clean condition.

**(e) Interference.** The Company-Controlled Site is located on or adjacent to property and infrastructure owned and operated by Company. Seller acknowledges and agrees that such property and infrastructure includes Company's existing communications configurations, equipment, and frequencies that exist on or adjacent to the Company-Controlled Site as of the Effective Date ("**Pre-existing Communications**"). Seller shall not construct, install, operate, use, maintain, repair, or remove any new or existing equipment that will materially interfere with the Pre-existing Communications and shall be responsible for resolving any technical interference problems between the Facility and the Pre-existing Communications. Seller additionally agrees to ensure that the Facility complies with any commercially reasonable communications requirements, specifications or rules developed by Company and provided to Seller with respect to the Company-Controlled Site throughout the Term of this Agreement. Seller shall inform and obtain Company's prior written approval before replacing any of its communications equipment or communications service providers (including internet equipment and internet service providers).

## **6. Prohibited Liens.**

**(a) Seller's Covenant.** Seller shall not permit any mechanic's, vendor's, laborer's, or material supplier's statutory lien or other similar lien arising from work, labor, services, equipment, or materials supplied, or claimed to have been supplied, to Seller (or anyone claiming through Seller) ("**Prohibited Lien**") to attach to the Company-Controlled Site or to any adjacent land owned by the Company. If a Prohibited Lien is filed, Seller shall, within 30 Days after receiving notice from Company of such filing (but in any case within 15 Days after Company notifies Seller of commencement of any application for a mechanic's lien or foreclosure proceedings), commence appropriate action to cause such Prohibited Lien to be paid, discharged, bonded, or cleared from title. Seller shall thereafter prosecute such action with

reasonable diligence and continuity. If Company receives notice of any such filing, then Company shall promptly notify Seller. Nothing in this Agreement shall be construed to obligate Seller regarding any lien that results from any act or omission by Company.

**(b) Protection of Company.** Nothing in this Agreement shall be deemed or construed in any way to constitute Company's giving Seller any right, power or authority to contract for, or permit the rendering of, any services, or the furnishing of any materials that would give rise to the filing of any liens against the Company-Controlled Site. Seller shall indemnify Company against any claims arising out of Construction undertaken by Seller or anyone claiming through Seller, and against all Prohibited Liens.

## **7. Hazardous Substances.**

**(a) Baseline Assessment.** At Seller's request, Company shall obtain a Phase I and/or Phase II Environmental Assessment (hereinafter defined), at Seller's sole cost, revealing the environmental conditions of the Company-Controlled Site prior to Seller's commencement of Construction on the Company-Controlled Site ("**Baseline Assessment**") and, subject to the confidentiality provisions of **Section 7(l)** (Confidentiality) of this **Attachment X** (Company-Controlled Site), shall provide Seller with a copy of the results of the Baseline Assessment. Any Hazardous Substances (hereinafter defined) not disclosed in any Baseline Assessment and discovered on the Company-Controlled Site after the Effective Date shall be presumed to be present as a result of Seller's utilization of the Company-Controlled Site during the Term, unless Seller shall prove, by clear and convincing proof, that the Hazardous Substances: (i) were present on the Company-Controlled Site prior to the Term; (ii) migrated onto the Company-Controlled Site as the result of the activities of a third party; or (iii) are present on the Company-Controlled Site as the result of Company's improper actions.

**(i)** For the purposes of this **Attachment X** (Company-Controlled Site): (A) "**Phase I Environmental Assessment**" means an environmental assessment and report prepared by a qualified environmental professional reasonably acceptable to Company that meets or exceeds the minimum requirements outlined in the then current version of the American Society of Testing and Materials Standard E 1527-00 (Standard Practice of Environmental Site Assessments: Phase I Environmental Site Assessment Process); and (B) "**Phase II Environmental Assessment**" means an environmental assessment and report prepared by a qualified environmental professional reasonably acceptable to Company that goes beyond the investigations of a Phase I Environmental Assessment and involves sampling and testing of the Company-Controlled Site, including (1) an asbestos survey conducted according to the standards of the Asbestos Hazard Emergency Response Act protocol; (2) testing of any transformers on the Company-Controlled Site for PCBs; (3) testing for lead based paints; (4) soil and groundwater sampling to measure the effect of any actual or suspected release or discharge of Hazardous Substances on the Company-Controlled Site; and (5) such other sampling and testing reasonably necessary to determine the environmental condition of the Company-Controlled Site.

**(ii)** For the purposes of this **Attachment X** (Company-Controlled Site), "**Hazardous Substances**" shall include flammable substances, explosives,

radioactive materials, asbestos, asbestos-containing materials, polychlorinated biphenyls, chemicals known to cause cancer or reproductive toxicity, pollutants, contaminants, hazardous wastes, medical wastes, toxic substances or related materials, petroleum and petroleum products, and any “hazardous” or “toxic” material, substance or waste that is defined by those or similar terms or is regulated as such under any Laws, including any material, substance or waste that is: (A) defined as a “hazardous substance” under Section 311 of the Water Pollution Control Act (33 U.S.C. §1317), as amended; (B) defined as a “hazardous waste” under Section 1004 of the Resource Conservation and Recovery Act of 1976, 42 U.S.C. §6901, et seq., as amended; (C) defined as a “hazardous substance” or “hazardous waste” under Section 101 of the Comprehensive Environmental Response, Compensation and Liability Act of 1980, as amended by the Superfund Reauthorization Act of 1986, 42 U.S.C. §9601 et seq. or any so-called “superfund” or “superlien” law; (D) defined as a “pollutant” or “contaminant” under 42 U.S.C. §9601(33); (E) defined as “hazardous waste” under 40 C.F.R. Part 260; (F) defined as a “hazardous chemical” under 29 C.F.R. Part 1910; or (G) subject to any other Laws regulating, relating to or imposing obligations, liability or standards of conduct concerning protection of human health, plant life, animal life, natural resources, property or the enjoyment of life or property free from the presence in the environment of any solid, liquid, gas, odor or any form of energy from whatever source.

**(b) Compliance with Environmental Law.** Seller shall keep and maintain the Company-Controlled Site, including the land, the air above the land, the surface and run-off water on the land, and the groundwater under the land, in compliance with, and shall not cause or permit the Company-Controlled Site or any portion of the Company-Controlled Site to be in violation of any Laws regarding: (i) air, environmental, ground water, soil conditions, or threatened or endangered species; or (ii) clean-up, control, disposal, generation, storage, release, transportation, or use of, or liability or standards of conduct concerning, Hazardous Substances (“**Environmental Law**”).

**(c) Use of Hazardous Substances.** Seller shall not cause or allow any deposit, discharge, generation, release, or spill of Hazardous Substances at or from the Company-Controlled Site, or that arises at any time from Seller’s operation of the Facility or any activities conducted on the Company-Controlled Site or any adjacent or nearby real property, or resulting from seepage, leakage, or other transmission of Hazardous Substances from other real property to the Company-Controlled Site, whether or not caused by Seller or the Company and whether occurring before or after the Effective Date (“**Hazardous Substances Discharge**”), except (i) in the ordinary course of Seller’s business (ii) in accordance with the instructions of the manufacturer and for the purpose described in such instructions, and (iii) in strict compliance with all applicable Environmental Law. Seller shall not install or remove any tank or combination of tanks (including pipes connected to the tanks) used to contain an accumulation of Hazardous Substances, and the volume of which (including the volume of the underground pipes connected to the tanks) is ten percent or more beneath the surface of the ground (“**Underground Storage Tank**”) on, within, under or about the Company-Controlled Site without first obtaining Company’s written approval. Seller shall not accept hazardous waste (as defined under any Environmental Law) generated off the Company-Controlled Site for any purpose, including treatment, storage or disposal.

**(d) List of Hazardous Substances.** On the Effective Date and on each anniversary of the Effective Date, and at any other time Company requests, Seller shall provide Company with a written list identifying any Hazardous Substances then used, stored, or maintained upon the Company-Controlled Site, the use and approximate quantity of each such material, a copy of any material safety data sheet (MSDS) issued by the manufacturer thereof, written information concerning the removal, transportation, and disposal of the same, and such other information as Company may reasonably require or as may be required by Law.

**(e) Notice of Disturbance of Any Hazardous Substances.** Seller shall provide Company 30 Days' prior notice before commencing any activities, including repair or remodeling of the Facility or the Company-Controlled Site or installation or removal of any personal property from the Company-Controlled Site, which could result in the disturbance of any Hazardous Substances. Together with such notice, Seller shall advise Company of protective measures to be taken by Seller to ensure that Hazardous Substances shall not be released and to ensure compliance with Environmental Law. Seller shall comply with all reasonable conditions (including adequate assurance of financial resources to comply with Environmental Law) that may be imposed by Company in connection with Seller's proposed activities.

**(f) Hazardous Substances Claims.** Seller shall immediately notify Company of: (i) any Hazardous Substances Claims (hereinafter defined); or (ii) Seller's discovery of any occurrence or condition of the Company-Controlled Site which could subject Seller or Company to any liability, or restrictions on ownership, occupancy, transferability or use of the Company-Controlled Site under any Environmental Law. For the purposes of this **Attachment X** (Company-Controlled Site), "**Hazardous Substances Claims**" shall mean (i) any actual, alleged or threatened Hazardous Substances Discharge; (ii) any and all enforcement, cleanup, removal, mitigation, remediation or other government actions instituted, contemplated or threatened pursuant to Environmental Law affecting the Company-Controlled Site; and (iii) all claims made or threatened by any third party against Seller or the Company-Controlled Site relating to damage, contribution, cost recovery, compensation, loss or injury resulting from any Hazardous Substances.

**(g) Remediation and Removal.** Except for the use of Hazardous Substances permitted by this **Attachment X** (Company-Controlled Site), Seller shall cause any Hazardous Substances Discharge to be: (i) remediated on-site in accordance with applicable Environmental Law; or (ii) removed from the Company-Controlled Site for remediation or disposal and to be transported solely by duly licensed Hazardous Substances transporters to duly licensed disposal facilities for final disposition to the extent required by and in accordance with applicable Environmental Law. Seller shall deliver to Company copies of any hazardous waste manifest reflecting the proper disposition of such Hazardous Substances. Except in emergencies or as otherwise required by Law, Seller shall not take any remedial or removal action in response to a Hazardous Substances Discharge without first notifying Company.

**(h) Proceedings on Hazardous Substances Claims; Indemnity.** Seller shall not enter into any legal proceeding or other action, settlement, consent decree or other compromise with respect to any Hazardous Substances Claims without first

notifying Company of Seller's intention to do so and affording Company the opportunity to join and participate as a party if Company so elects in such proceedings. Seller shall be solely responsible for and shall indemnify Company against any Hazardous Substances Claims, including: (i) the costs of any required or necessary removal, repair, cleanup or remediation of the Company-Controlled Site, and the preparation and implementation of any closure, removal, remedial or other required plans; and (ii) all reasonable costs and expenses incurred by Company in connection therewith, including legal costs.

**(i) Assurance of Performance.**

**(i) Company's Phase II Environmental Assessment.** Company may, but shall not be required to, engage such contractors as Company determines to be appropriate to perform from time to time a Phase II Environmental Assessment, including environmental sampling and testing, of: (A) the Company-Controlled Site, the surrounding soil and any adjacent areas, and any ground water located under or surface water located adjacent to the Company-Controlled Site or any adjoining property; (B) Seller's compliance with all Environmental Law and the provisions of this **Attachment X** (Company-Controlled Site); and (C) the provisions made by Seller for carrying out any removal or remedial action that may be required by reason of the nature of Seller's business and operations on the Company-Controlled Site.

**(ii) Cost of Assessment.** All costs and expenses incurred by Company in connection with any such Phase II Environmental Assessment shall be paid by Company, except that if any such Phase II Environmental Assessment shows that: (A) the environmental condition of the Company-Controlled Site has materially declined in comparison to any Baseline Assessment; (B) Seller has failed to comply with the provisions of this **Attachment X** (Company-Controlled Site) with respect to Hazardous Substances; (C) the Company-Controlled Site (including surrounding soil and any underlying groundwater or adjacent surface water) has become contaminated due to operations or activities not attributable to the Company; or (D) an event that is the basis for a Hazardous Substances Claim occurred during the Term, then all of the costs and expenses of such assessment shall be paid by Seller.

**(iii) Conducting Assessment.** Each Phase II Environmental Assessment shall be conducted: (A) only after advance notice of such assessment has been provided to Seller at least 10 Days prior to the date of the assessment; and (B) in a manner reasonably designed to minimize the interruption of Seller's operations and use of the Company-Controlled Site. Company shall repair any substantial damage to the Company-Controlled Site or to the Facility that is directly caused by Company (but not the environmental consultant) during the Phase II Environmental Assessment.

**(j) Seller's Obligations Prior to End of Term.**

**(i) Seller's Phase I and Phase II Environmental Assessment Deposit.** No later than 18 months prior to the date upon which this Agreement terminates, i.e., the end of the Term, Seller shall deposit with Company a sum equal to the then current estimated cost of conducting a Phase I and Phase II Environmental Assessment of the Company-Controlled Site. Company shall hold such sum for Seller and shall apply or reimburse such sum as provided in this section.

**(ii) Phase I (or Phase II) Environmental Assessment.**

**(A)** No later than the beginning of the last year of the Term, or immediately upon earlier termination of the Term, Company shall cause a Phase I Environmental Assessment of the Company-Controlled Site to be conducted and may apply the sums previously deposited by Seller to pay for such assessment.. If the assessment costs more than the amount of the deposit, Seller shall pay to Company, upon demand, the difference. If the assessment costs less than the amount of the deposit, and if the Phase I Environmental Assessment does not identify areas of concern that in Company's reasonable judgment indicate that further investigation is required, Company shall, no later than 30 Days after payment in full of the cost of the Phase I Environmental Assessment, return to Seller a sum equal to the amount by which the deposit exceeds the actual costs of such assessment. In addition, no later than the end of the Term, Seller shall (1) cause all Hazardous Substances previously owned, stored or used by Seller to be removed from the Company-Controlled Site and disposed of in accordance with all Environmental Law; and (2) remove any Underground Storage Tanks or other containers installed or used by Seller to store any Hazardous Substances on the Company-Controlled Site, and repair any damage to the Company-Controlled Site caused by such removal.

**(B)** If Company's Phase I Environmental Assessment identifies areas of concern that in Company's reasonable judgment indicate that further investigation is required, Company shall cause a Phase II Environmental Assessment of the Company-Controlled Site to be conducted and may apply the sums previously deposited by Seller to pay for such assessment. If the assessment costs more than the amount of the deposit, Seller shall pay to Company, upon demand, the difference. If the assessment costs less than the amount of the deposit, Company shall, no later than 30 Days after payment in full of such costs, return to Seller a sum equal to the amount by which the deposit exceeds the actual costs of such assessment. Seller expressly acknowledges and agrees that Seller's covenant and obligation to pay all costs and expenses associated with any Phase II Environmental Assessment required under this section, whether commissioned by Seller or Company, shall survive termination of this Agreement.

**(k) Clean-up.**

**(i) Environmental Report.** If any written report containing results of any Phase I Environmental Assessment ("**Environmental Report**") shall: (A) reveal that the environmental condition of the Company-Controlled Site has materially declined in comparison to the Baseline Assessment; or (B) Seller has materially violated any warranty, representation, or covenant of this **Attachment X** (Company-Controlled Site); or (C) recommend the repair, closure, remediation, removal or other clean-up (collectively, the "**Clean-up**") of any Hazardous Substances found on or about the Company-Controlled Site, and if Company determines that Seller is responsible for such Clean-up, then:

(A) Company shall provide Seller with a copy of such Environmental Report and with a written explanation of the reasons why Company believes that Seller is responsible under the principles of this section for conducting the Clean-up identified in such Environmental Report.



(B) If, within 30 Days after receiving a copy of such Environmental Report and such written statement, Seller fails either (1) to complete the Clean-up, or (2) with respect to any Clean-up which cannot be completed within such 30-Day period, fails to proceed with reasonable diligence to complete such Clean-up as promptly as practicable, then Company shall have the right, but not the obligation, to carry out any Clean-up recommended by the Environmental Report or required by any Governmental Authority, and to recover all of the costs and expenses of such Clean-up from Seller from the date Company incurred such costs and expenses until paid in full.

**(ii) Emergency.** If the Environmental Report reveals a situation which, in Company's sole discretion, constitutes an emergency, then Company shall have the right, but not the obligation, to carry out any Clean-up recommended by the Environmental Report or required by any Governmental Authority, and to recover all of the costs and expenses of such Clean-up from Seller from the date Company incurred such costs and expenses until paid in full.

**(iii) Submission of Report to Government.** To the extent required by Laws, Company shall be entitled to submit the Environmental Report to any Governmental Authority.

**(iv) Completion of Clean-up Before Termination.** Seller shall complete Clean-up prior to termination of this Agreement, and shall fully comply with all Environmental Law and requirements of any Governmental Authority over the Clean-up, including any requirement to file such assessment, mitigation plan, risk assessment or other information with any such Governmental Authority prior to such termination.

**(v) Seller's Inability to Complete.** Should any such Clean-up for which Seller is responsible not be completed or should Seller not receive any Approvals regarding the Company-Controlled Site or areas adjacent to the Company-Controlled Site required under Environmental Law prior to the expiration or sooner termination of this Agreement, including any extensions of this Agreement, then Seller shall deposit with Company an amount of money equal to the balance of the estimated costs of the Clean-up.

**(I) Confidentiality.**

**(i) Keeping Information Confidential.** Except if required to do so by Law, or compelled by subpoena or discovery proceedings in any legal action or governmental proceeding, Seller agrees that Seller shall not disclose, discuss, disseminate or copy any information, data, findings, communications, conclusions and reports regarding the environmental condition of the Company-Controlled Site, to any person, including any Governmental Authority, without the prior written consent of Company. Upon completion of any Clean-up of the Company-Controlled Site, Seller shall deliver and return to Company, all information, data, findings, communications, conclusions and reports regarding the environmental condition of the Company-Controlled Site whether provided to Seller by Company or not.

**(ii) Scope of Obligation.** Seller's obligation to maintain the

confidentiality of all information, data, findings, communications, conclusions and reports regarding the environmental condition of the Company-Controlled Site, include but are not limited to Seller's officers, employees, agents, attorneys, environmental consultants and contractors. Seller's obligation to maintain the confidentiality of all information, data, findings, communications, conclusions and reports regarding the environmental condition of the Company-Controlled Site, shall survive the termination of this Agreement.

**(m) Copies of Environmental Reports.** Seller shall provide Company with a copy of any and all environmental assessments, audits, studies and reports regarding Seller's past or current activities on the Company-Controlled Site or the environmental condition of the Company-Controlled Site within 30 Days of Seller's receipt of such materials. Seller shall be obligated to provide Company with a copy of such materials without regard to whether they are generated by Seller or prepared for Seller, or how Seller comes into possession of such materials.

**(n) Survival of Agreements.** The covenants of this section, including the indemnification provision, shall survive the expiration or termination of this Agreement, or any termination of Seller's utilization of the Company-Controlled Site.

## **8. Archeological and Historical Items.**

**(a) Discovery of Items.** In the event any human remains, artifacts, historical items, or any of them (collectively the "**Discovered Items**") are discovered on the Company-Controlled Site, Seller shall, at Seller's sole expense and subject to the approval of Company, be responsible to: (i) cause all excavation in the immediate area which may damage the Discovered Items and the potential historic site to cease; (ii) cause the site to be stabilized and secured to temporarily protect the Discovered Items against damage, theft, or both; (iii) cause the Discovered Items to be left untouched so that their archaeological or historical context may be accurately documented; and (iv) cause the discovery to be reported immediately to Company and to Governmental Authorities as required by applicable Laws. If the artifacts or historical items are found without human remains, and leaving the artifacts or historical items in their stabilized and secured site poses a substantial risk of loss or damage to all or part of them, and their removal is therefore necessary, Seller shall cause such removal and shall cause any tampering with the artifacts, the historical items, and the site to be minimized as much as possible.

**(b) Human Remains.** In the case of the discovery of human remains, Seller shall, at Seller's sole expense and in addition to the duties set forth in this section, cause to be prepared and executed a mitigation plan acceptable to Company and to Governmental Authorities possessing jurisdiction over such matters. Seller shall also be responsible to obtain written verification that the mitigation plan has been successfully implemented.

**(c) Company's Reservation.** If any Discovered Items are discovered, then Company shall have the right at all reasonable times to enter the Company-Controlled Site upon reasonable notice for the purposes of searching for, exploring for, and removing any of the Discovered Items for preservation as permitted by applicable Laws. All objects, antiquities and specimens of Hawaiian or other ancient art or

handicraft or of prehistoric, historic or archaeological interest found on the Company-Controlled Site belong to and at all times shall remain the property of Company.

**(d) No Studies by Seller.** No archaeological studies or historic preservation studies may be sought to be conducted in or on the Company-Controlled Site by Seller or anyone acting by or through Seller. If Seller wishes to conduct such studies, or if Seller is required by applicable Laws to permit such studies (Seller to provide bases for conclusion that such Laws mandate any such requested studies), Seller shall obtain Company's prior written consent and shall permit Company, at its option, to commission such studies as required, or Company may permit Seller to commission such studies provided that Seller shall provide Company with prior notice of the commencement of such studies. If Seller commissions such studies, Seller shall upon completion of such studies cause a complete copy of the results of such studies to be provided to Company at the earliest opportunity but no later than 15 days after its issuance.

## **9. Transfers.**

**(a) Company's Right to Convey.** Company may transfer title to the Company-Controlled Site from time to time at any time without prior notice to, or consent from, Seller, provided that any such transfer is subject to Seller's right to utilize the Company-Controlled Site under this Agreement. Company will promptly notify Seller of such a transfer.

**(b) Seller's Limited Right.** Seller may only transfer the rights to utilize the Company-Controlled Site under this **Attachment X** (Company-Controlled Site) to a permitted assignee of all of the rights and obligations of the Seller under this Agreement. Any attempt by Seller to separately transfer the rights to utilize the Company-Controlled Site under this **Attachment X** (Company-Controlled Site) shall be void. Any permitted assignee of Seller shall assume all obligations and liabilities of Seller under this **Attachment X** (Company-Controlled Site). No transfer shall affect any obligations of Seller or rights of Company under this **Attachment X** (Company-Controlled Site).

## **10. End of Term.**

**(a) Improvements.** Upon the termination of this Agreement, or in the event this Agreement is declared null and void under either **Section 2.3** (Interconnection Requirements Study), **Section 3.4** (Prior to Effective Date), **Section 24.3** (Time Period for PUC Submittal Date), or **Section 24.4** (Time Period for PUC Approval) of this Agreement ("**Agreement Termination**"), at Company's option: (i) all improvements on the Company-Controlled Site shall become Company's property; or (ii) Seller shall, at its sole cost and expense, remove all Seller-constructed improvements, including the Facility, the Company-Owned Interconnection Facilities and the Seller-Owned Interconnection Facilities ("**Improvements**") from the Company-Controlled Site, and, in conjunction with such removal, shall develop and implement a program to recycle, to the fullest extent possible, or to otherwise properly dispose of, all such removed infrastructure.

**(b) Seller's Removal of Improvements.** If Seller is required to remove the

Improvements upon Agreement Termination, Seller shall have reasonable access to the Company-Controlled Site for a period of up to 90 Days after termination of this Agreement to dismantle, pack and remove the Improvements from the Company-Controlled Site (the “**Removal Period**”). Seller shall work promptly and diligently to remove the Improvements. The Removal Period shall end upon Seller’s completion of removal of the Improvements from the Company-Controlled Site. The terms and provisions of this Agreement shall apply during the Removal Period, including Seller’s obligations to provide insurance and to indemnify Company.

**(c) Company’s Removal of Improvements.** If Company determines that Seller is not making diligent efforts to remove the Improvements, or if Company has operational concerns over the removal of the Improvements, Company shall notify Seller of Company’s intention to remove the Improvements at Seller’s cost. Company shall notify Seller of Company’s election to have Seller remove the Improvements not later than 90 Days before the end of the Term.

**(d) Restoration of the Company-Controlled Site.** After Agreement Termination and removal of Seller’s Improvements by Seller or by Company, as the case may be, Seller shall, at its sole cost and expense, restore the Company-Controlled Site to its condition prior to Seller’s Construction. Restoration pursuant to this Section shall be completed within 90 Days of Agreement Termination, or as otherwise agreed to by both Parties in writing.

**(e) Assignment of Rights.** If Company exercise its option under **Section 10(a)** (Improvements) of this **Attachment X** (Company-Controlled Site) to take title to the Improvements, Seller shall assign to Company, without recourse, and give Company copies or originals of, all assignable licenses, permits, contracts, warranties, and guarantees then in effect for the Facility.

**(f) Orderly Transition.** The parties shall cooperate to achieve an orderly transition of operations from Seller to Company without interruption, including delivery of such books and records (or copies thereof) as Company reasonably requires.

## **11. Miscellaneous.**

**(a) Modification.** The parties reserve the right to modify this **Attachment X** (Company-Controlled Site) by mutual agreement set forth in writing. Such modifications shall not be considered amendments to this Agreement requiring PUC approval.

**(b) Security.** Seller acknowledges and agrees that Seller’s performance under this **Attachment X** (Company-Controlled Site) is secured by both the Development Period Security and the Operating Period Security. Any costs and expenses due to Company, or reimbursable to Company, may at Company’s option, be paid or reimbursed to Company from the applicable Development Period Security or Operating Period Security.

**(c) Confidential Information.** Without limitation of the obligations set forth elsewhere in this Agreement, each party (including its officers, directors, employees,

representatives, brokers, attorneys and advisers) shall, except as otherwise provided by applicable Laws, or in connection with proceedings before the State of Hawaii Public Utilities Commission or other Governmental Authority with jurisdiction over the Company-Controlled Site or this Agreement, or in connection with the evaluation for financing, or as part of disclosure to its affiliates, attorneys, consultants, and advisers in order to conduct its business or proceedings to enforce this **Attachment X** (Company-Controlled Site) or this Agreement, keep the contents of this **Attachment X** (Company-Controlled Site) and any information related to the Company-Controlled Site, Seller and the Seller's utilization of the Company-Controlled Site pursuant to this **Attachment X** (Company-Controlled Site) confidential, whether or not marked as "confidential" (collectively, the "**Confidential Information**"). The Confidential Information shall not include any information publicly known, or which becomes publicly known, other than through the acts of a party to the Agreement, or any of their respective officers, directors, employees, representatives, brokers, attorneys or advisers. Seller may retain possession of all or any part of the Confidential Information to the extent such Confidential Information relates solely to the Facility and Seller's operation of the Facility.

**(d) No Real Property Interest Conveyed.** Notwithstanding anything to the contrary contained herein, this Agreement shall not result in the conveyance or transfer to Seller, directly or indirectly, expressly or impliedly, or give rise to, any real property right, title, or interest.

**DRAFTING NOTES:**

- 1. ATTACHMENT X MAY BE REVISED TO ACCOUNT FOR MATTERS SUCH AS THE SPECIFICS OF THE SITE IN QUESTION, SELLER'S FACILITY AND ANY NECESSARY ACCESS ARRANGEMENTS THROUGH COMPANY'S FACILITIES.**
- 2. PROVISIONS OF THE AGREEMENT CONCERNING MATTERS SUCH AS LAND RIGHTS, SCOPE OF INDEMNIFICATION AND DRAWS UPON DEVELOPMENT PERIOD SECURITY OR OPERATING PERIOD SECURITY WILL BE REVISED TO ACCOUNT FOR ATTACHMENT X.**

**EXHIBIT X.1**  
**SITE PLAN**  
**[TO BE DETERMINED]**

FILED

2021 Oct 29 PM 15:59

PUBLIC UTILITIES  
COMMISSION

The foregoing document was electronically filed with the State of Hawaii Public Utilities Commission's Document Management System (DMS).

CERTIFICATE OF SERVICE

Pursuant to Order No. 37043, the foregoing order was served on the date it was uploaded to the Public Utilities Commission's Document Management System and served through the Document Management System's electronic Distribution List.



FILED

2022 Jan 25 AM 11:27

PUBLIC UTILITIES  
COMMISSION

The foregoing document was electronically filed with the State of Hawaii Public Utilities Commission's Document Management System (DMS).